



### Features

- Multiple Frequency Outputs
  - Fo: 9.60GHz to 10.8GHz
  - Fo/2: 4.80GHz to 5.40GHz
  - Fo/4: 2.40GHz to 2.70GHz
- No External Resonator Required
- Integrated Frequency Divider
- Phase Noise: -114dBc/Hz at 100kHz Offset
- Flat Output Power Over Frequency Tuning Range 1.5V to 14.5V
  - Fo: 8dBm
  - Fo/2: 8dBm
  - Fo/4: -2dBm
- Low Power Consumption
  - 5V/275mA (Divider On)
  - 5V/215mA (Divider Off)
- 32-Lead 5mm x 5mm Plastic Over-Molded QFN

### Applications

- Point-Point Radio
- Point-Multipoint Radio
- Satellite Communications
- Test Equipment
- Military
- Aerospace

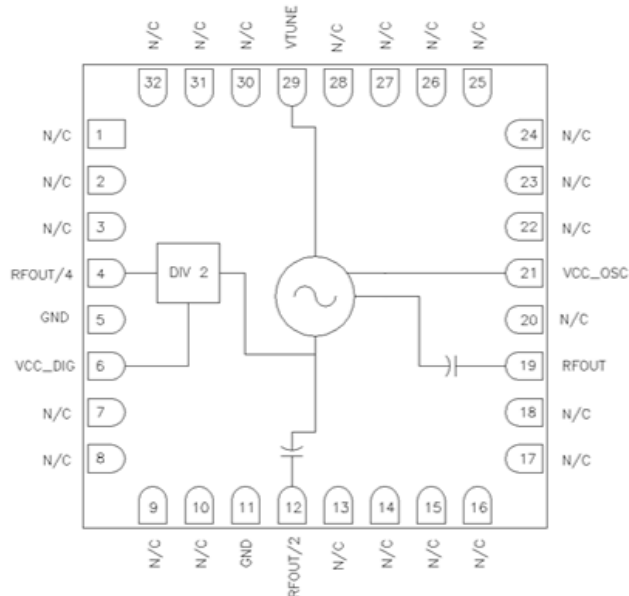

Functional Block Diagram

### Product Description

RFMD's RFVC1835 is a 5V InGaP MMIC VCO with an integrated frequency divider providing additional Fo/2 and Fo/4 outputs. With an Fo frequency range of 9.6GHz to 10.8GHz its monolithic structure provides excellent temperature, shock, and vibration performance. Output power (Fo) is +8dBm and is flat across the tuning voltage range of 1.5V to 14.5V. Phase noise is typically -114dBc/Hz at 100KHz offset. The device operates from a low supply current of 275mA which can be further reduced to 215mA by disabling the divider functions if not required. The RFVC1835 is available in a low cost 5mm x 5mm surface mount plastic over-molded QFN outline.

### Ordering Information

RFVC1835S2	2-Piece sample bag
RFVC1835SB	5-Piece bag
RFVC1835SQ	25-Piece bag
RFVC1835SR	100 Pieces
RFVC1835TR7	750 Pieces on a 7" reel
RFVC1835PCBA-410	Evaluation Board

### Optimum Technology Matching® Applied

- |   |                                      |                                     |                                    |
|---|--------------------------------------|-------------------------------------|------------------------------------|
| <input type="checkbox"/> GaAs HBT             | <input type="checkbox"/> SiGe BiCMOS | <input type="checkbox"/> GaAs pHEMT | <input type="checkbox"/> GaN HEMT  |
| <input type="checkbox"/> GaAs MESFET          | <input type="checkbox"/> Si BiCMOS   | <input type="checkbox"/> Si CMOS    | <input type="checkbox"/> BiFET HBT |
| <input checked="" type="checkbox"/> InGaP HBT | <input type="checkbox"/> SiGe HBT    | <input type="checkbox"/> Si BJT     | <input type="checkbox"/> LDMS      |

RF MICRO DEVICES®, RFMD®, Optimum Technology Matching®, Enabling Wireless Connectivity™, PowerStar®, POLARIS™ TOTAL RADIO™ and UltimateBlue™ are trademarks of RFMD, LLC. BLUETOOTH is a trademark owned by Bluetooth SIG, Inc., U.S.A. and licensed for use by RFMD. All other trade names, trademarks and registered trademarks are the property of their respective owners. ©2011, RF Micro Devices, Inc.

## Absolute Maximum Ratings

Parameter	Rating	Unit
V <sub>CC_OSC</sub> , V <sub>CC_DIG</sub>	+5.5	V
V <sub>TUNE</sub>	0 to +15	V
Junction Temperature (T <sub>j</sub> )	135	°C
Continuous P <sub>DISS</sub> (T <sub>A</sub> = 85 °C) (derate 37mW/°C above T <sub>A</sub> = 85 °C)	1.65	W
Junction to Case, Thermal Resistance (R <sub>θ(j-a)</sub> )	30	°C/W
Storage Temperature	-65 to +150	°C
Operating Temperature	-40 to +85	°C
ESD Sensitivity (HBM)	Class 1A	



**Caution!** ESD sensitive device.

Exceeding any one or a combination of the Absolute Maximum Rating conditions may cause permanent damage to the device. Extended application of Absolute Maximum Rating conditions to the device may reduce device reliability. Specified typical performance or functional operation of the device under Absolute Maximum Rating conditions is not implied.

The information in this publication is believed to be accurate and reliable. However, no responsibility is assumed by RF Micro Devices, Inc. ("RFMD") for its use, nor for any infringement of patents, or other rights of third parties, resulting from its use. No license is granted by implication or otherwise under any patent or patent rights of RFMD. RFMD reserves the right to change component circuitry, recommended application circuitry and specifications at any time without prior notice.



RFMD Green: RoHS compliant per EU Directive 2002/95/EC, halogen free per IEC 61249-2-21, < 1000ppm each of antimony trioxide in polymeric materials and red phosphorus as a flame retardant, and <2% antimony in solder.

Parameter	Specification			Unit	Condition
	Min.	Typ.	Max.		
<b>Electrical Specifications</b>					V <sub>CC</sub> = 5V, T <sub>A</sub> = +25 °C
Operating Frequency					
F <sub>o</sub>	9.60		10.8	GHz	
F <sub>o/2</sub>	4.80		5.40	GHz	
F <sub>o/4</sub>	2.40		2.70	GHz	
Output Power					
F <sub>o</sub>		8		dBm	
F <sub>o/2</sub>		8		dBm	
F <sub>o/4</sub>		-2		dBm	
SSB Phase Noise					
10kHz offset at RF <sub>OUT</sub>		-88		dBc/Hz	V <sub>TUNE</sub> = +5V
100kHz offset at RF <sub>OUT</sub>		-114		dBc/Hz	
Tune Voltage	1.5		14.5	V	
Supply Current					
V <sub>CC_OSC</sub>		215		mA	
V <sub>CC_DIG</sub>		60		mA	
Tune Port Leakage Current		10		µA	
Output Return Loss		5		dB	
Harmonics/Sub-harmonics					Measured with RF probes at package, not at SMA connections on EVB
1/2		35		dBc	
3/2		35		dBc	
2nd		10		dBc	
3rd		20		dBc	
Pulling (into a 2.0:1 VSWR)		5		MHz pp	
Pushing		25		MHz/V	
Frequency Drift Rate		0.8		MHz/°C	

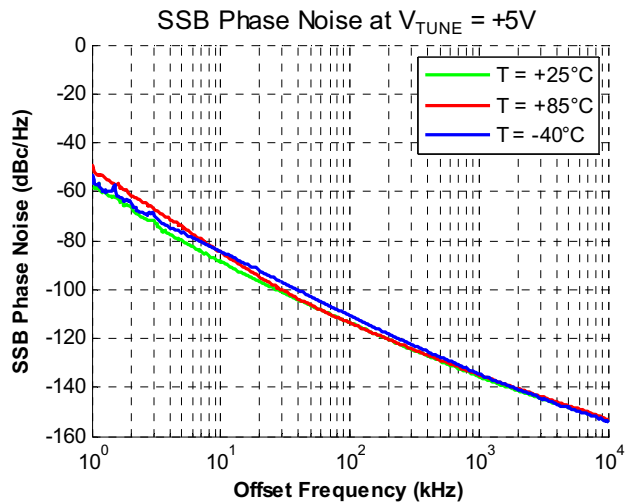
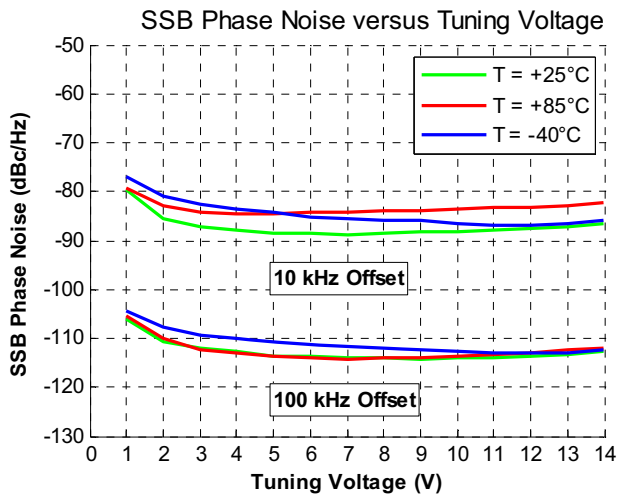
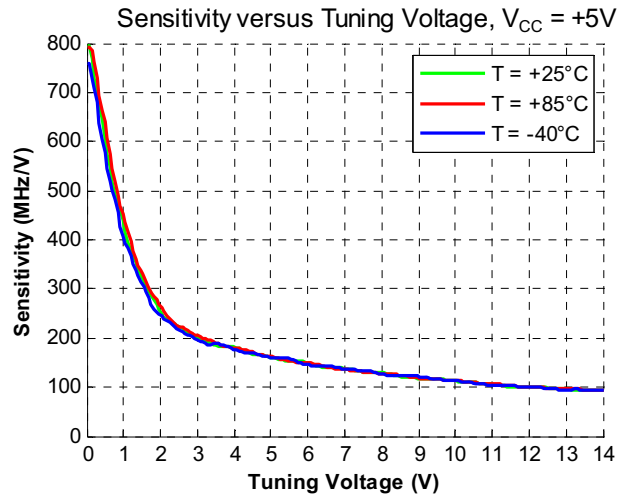
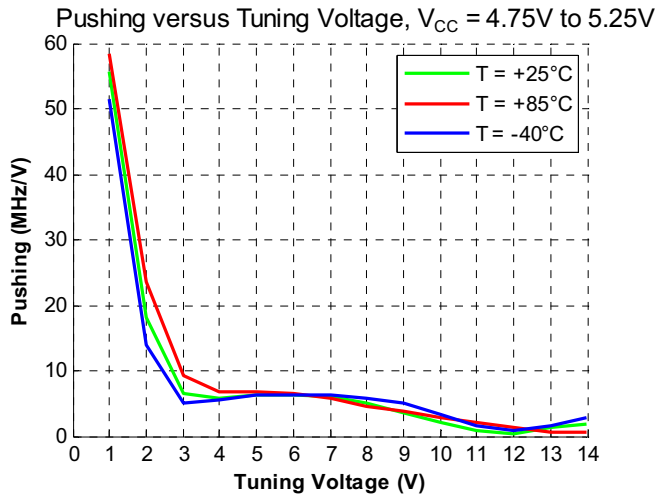
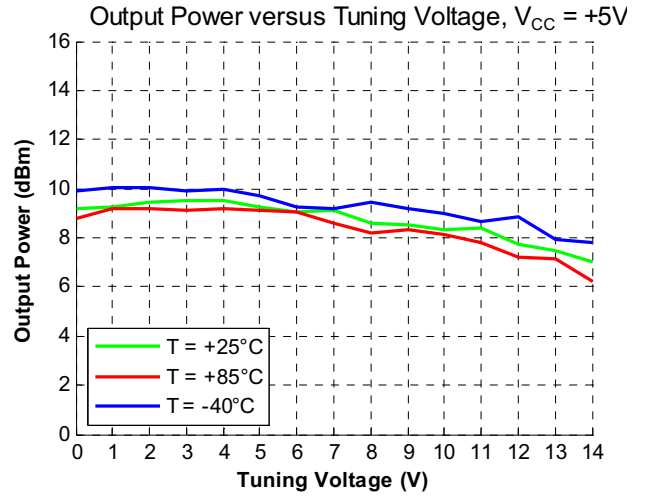
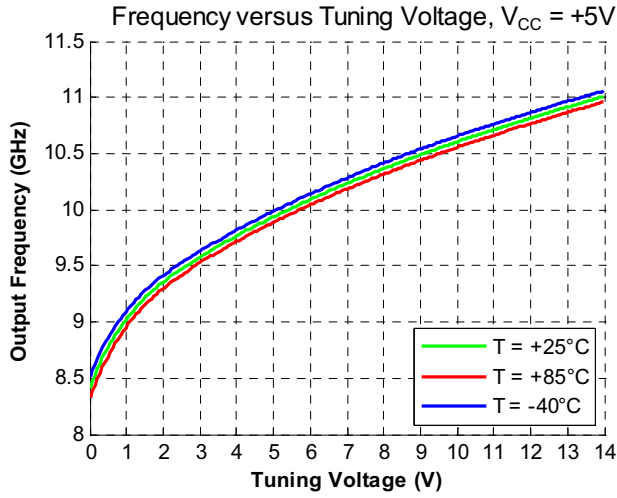

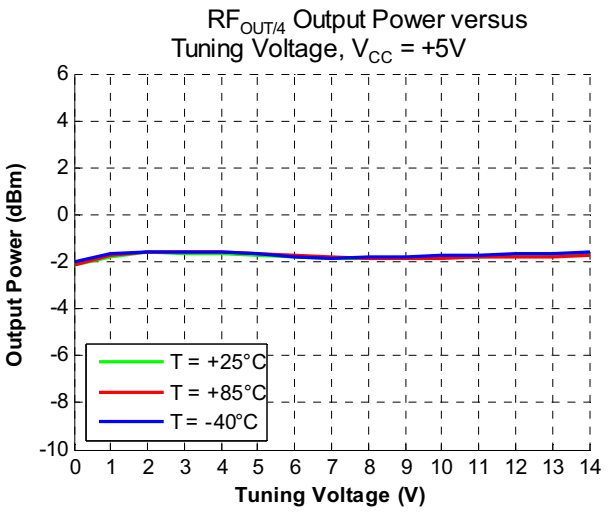
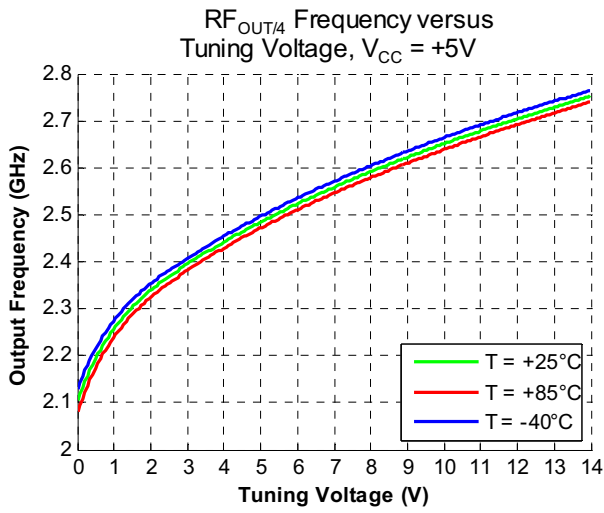
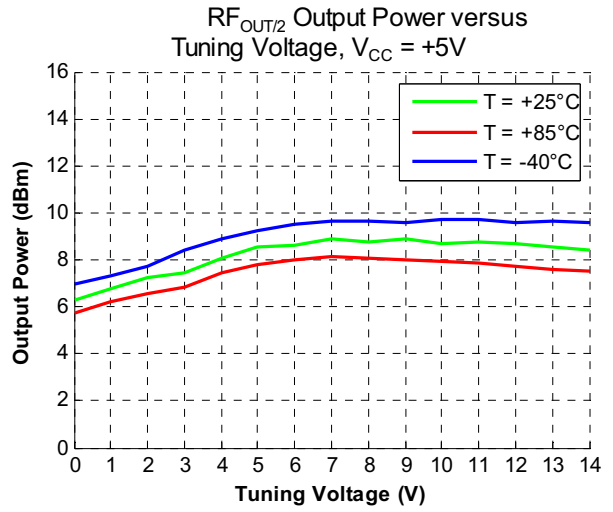
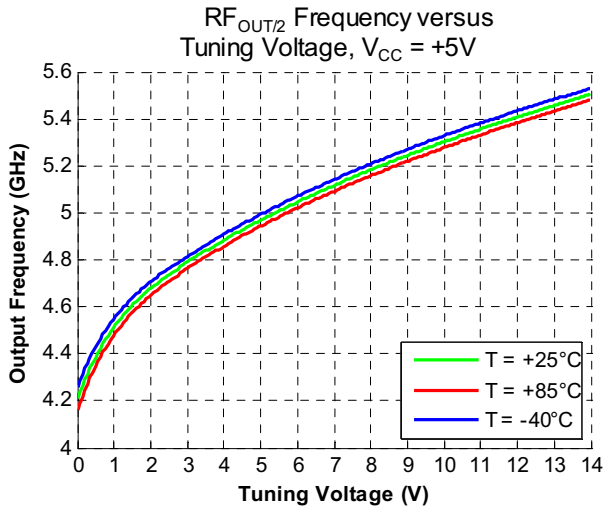

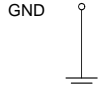
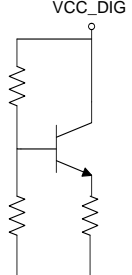
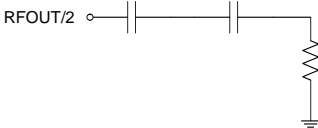
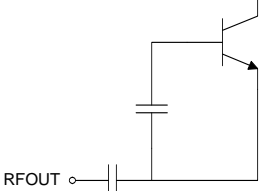
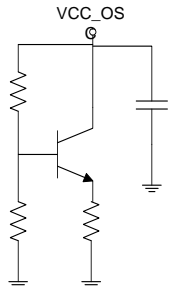
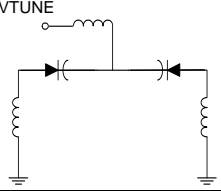
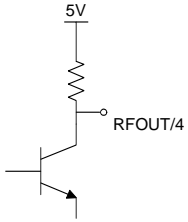
Pin	Name	Description	Interface Schematic
5, 11, Pkg Base	<b>GND</b>	Connect to PCB ground	
6	<b>VCC_DIG</b>	Supply voltage input for the integrated frequency divider Typical +5V Ground this pin to disable digital divider and reduce current consumption by 60mA	
12	<b>RFOUT/2</b>	VCO RF output at $F_o/2$ . Internally DC blocked	
19	<b>RFOUT</b>	VCO RF output at $F_o$ . Internally DC blocked	
21	<b>VCC_OSC</b>	Supply voltage input for the VCO Typical +5 V	
29	<b>VTUNE</b>	VCO control voltage input	
4	<b>RFOUT/4</b>	VCO RF output at $F_o/4$ . Externally DC blocked	
1-3, 7-10, 13-18, 20, 22-28, 30-32	<b>N/C</b>	No internal connection	

## Package Drawing

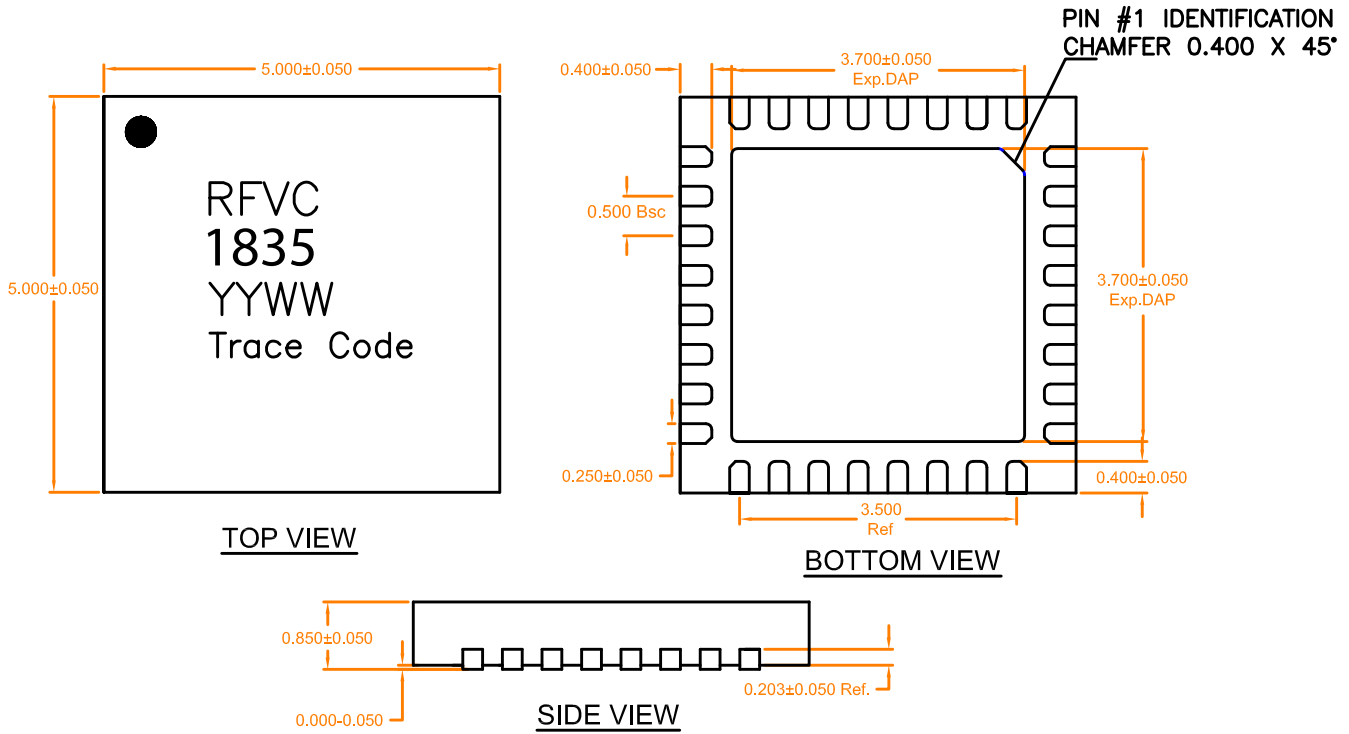

## Recommended PCB Layout

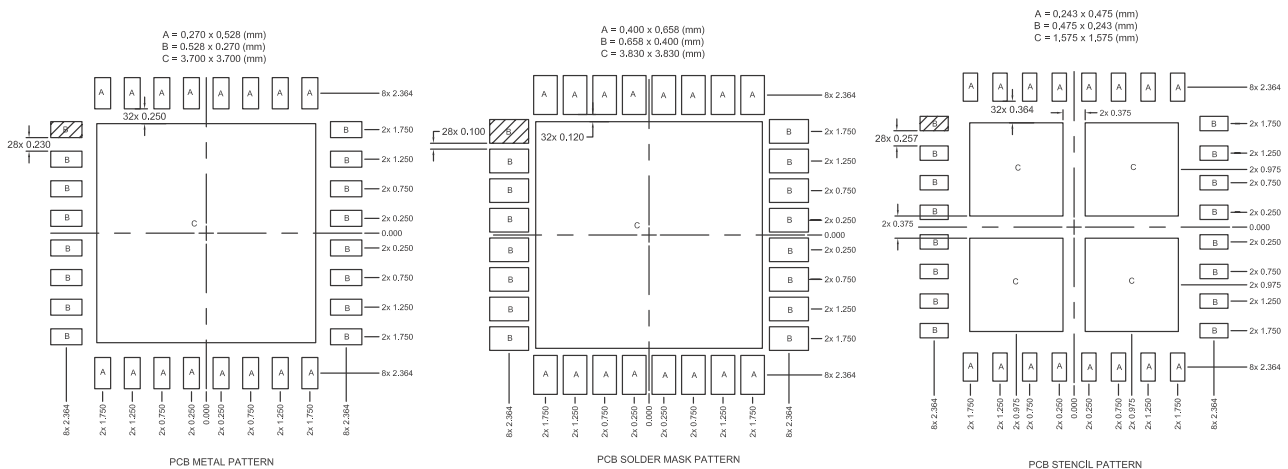

Thermal vias for center slug "C" should be incorporated into the PCB design. The number and size of thermal vias will depend on the application, the power dissipation, and the electrical requirements. Example of the number and size of vias can be found on the RFMD evaluation board layout.

Shaded areas represent Pin 1 location.

**Sample Application Circuit Schematic**

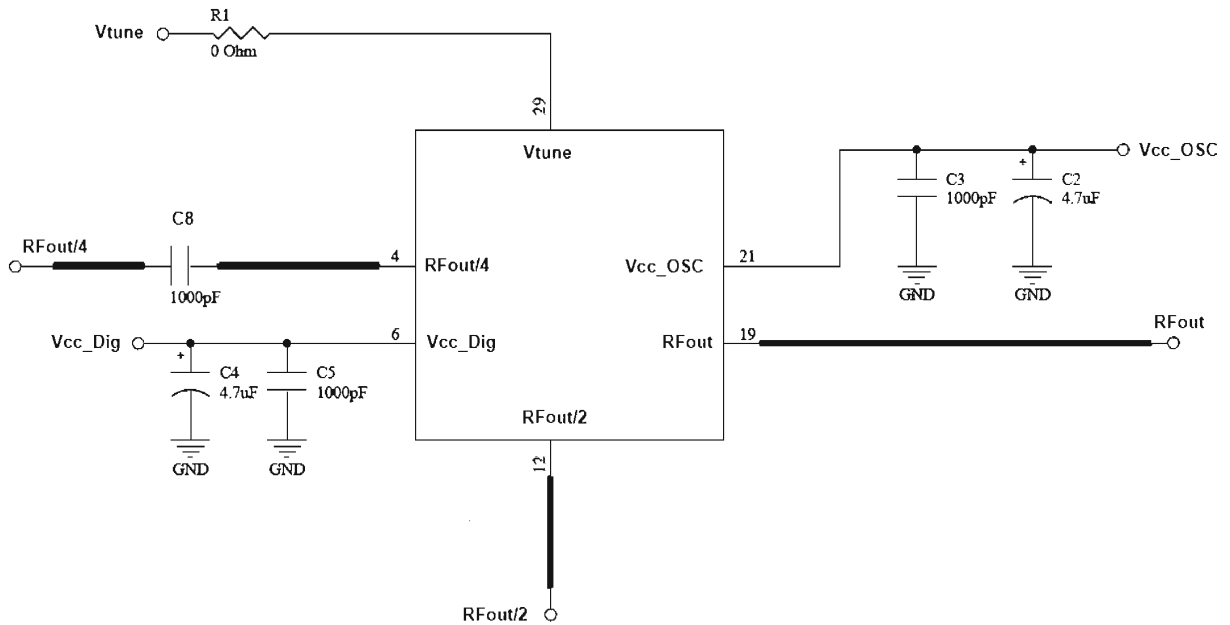

Bias Conditions	Output
V <sub>CC_osc</sub> = 5 V	F <sub>OUT</sub> = 10.0 GHz
V <sub>CC_Dig</sub> = 5 V	F <sub>OUT/2</sub> = 5.00 GHz
V <sub>TUNE</sub> = 5 V	F <sub>OUT/4</sub> = 2.50 GHz

