

Package: S-20



Features

- Frequency Range 5 MHz to 1000 MHz
- Low Cost and RoHS Compliant
- Industry Standard SMT package
- Available in Tape-and-Reel
- 50Ω Characteristic Impedance
- Transmission Line

Applications

- Broadband/CATV
- Wireless

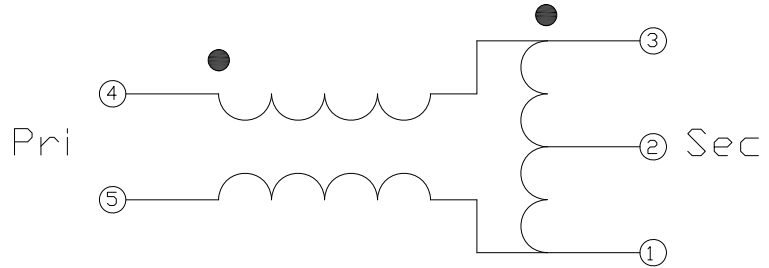

Schematic

Product Description

The RFXF4513 Transformer is designed for applications that require small, low cost, and highly reliable surface mount components. Applications may be found in broadband, wireless, and other communications systems. These units are built Lead-Free and RoHS compliant. S-Parameters are available on request.

Optimum Technology Matching® Applied

- | | | | |
|--------------------------------------|--------------------------------------|-------------------------------------|------------------------------------|
| <input type="checkbox"/> GaAs HBT | <input type="checkbox"/> SiGe BiCMOS | <input type="checkbox"/> GaAs pHEMT | <input type="checkbox"/> GaN HEMT |
| <input type="checkbox"/> GaAs MESFET | <input type="checkbox"/> Si BiCMOS | <input type="checkbox"/> Si CMOS | <input type="checkbox"/> BiFET HBT |
| <input type="checkbox"/> InGaP HBT | <input type="checkbox"/> SiGe HBT | <input type="checkbox"/> Si BJT | <input type="checkbox"/> LDMOS |

RF MICRO DEVICES®, RFMD®, Optimum Technology Matching®, Enabling Wireless Connectivity™, PowerStar®, POLARIS™ TOTAL RADIO™ and UltimateBlue™ are trademarks of RFMD, LLC. BLUETOOTH is a trademark owned by Bluetooth SIG, Inc., U.S.A. and licensed for use by RFMD. All other trade names, trademarks and registered trademarks are the property of their respective owners. ©2006, RF Micro Devices, Inc.

Absolute Maximum Ratings

Parameter	Rating	Unit
RF Power	2	W
Operating Temperature	-45 to +85	°C
Storage Temperature	-55 to +100	°C



Caution! ESD sensitive device.

Exceeding any one or a combination of the Absolute Maximum Rating conditions may cause permanent damage to the device. Extended application of Absolute Maximum Rating conditions to the device may reduce device reliability. Specified typical performance or functional operation of the device under Absolute Maximum Rating conditions is not implied.

The information in this publication is believed to be accurate and reliable. However, no responsibility is assumed by RF Micro Devices, Inc. ("RFMD") for its use, nor for any infringement of patents, or other rights of third parties, resulting from its use. No license is granted by implication or otherwise under any patent or patent rights of RFMD. RFMD reserves the right to change component circuitry, recommended application circuitry and specifications at any time without prior notice.



RoHS (Restriction of Hazardous Substances): Compliant per EU Directive 2002/95/EC.

Parameter	Specification			Unit	Condition
	Min.	Typ.	Max.		
Overall					Typical values represent Mid-Band performance at 25 °C
Frequency Range	5		1000	MHz	
Insertion Loss < 1dB	5		850	MHz	
Insertion Loss < 1.5dB	5		1000	MHz	
Amplitude Balance		0.3	0.5	dB	
Phase Balance		3	5	°	Nominal Phase Difference is 180°
Input Return Loss	12	14		dB	
Impedance Ratio, P:S	1:1				
Type - Transmission Line	Unbalance to Balanced				

Input Return Loss

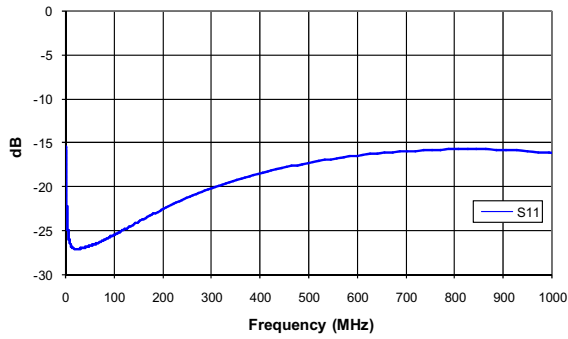

Insertion Loss

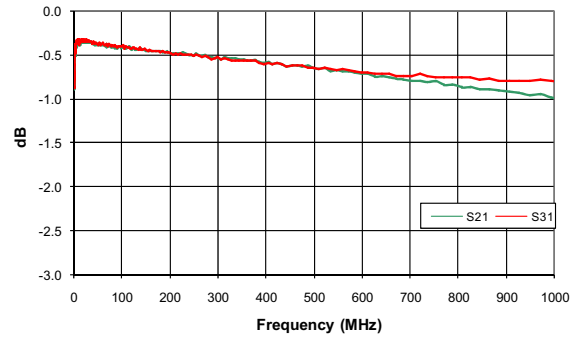

Amplitude Balance

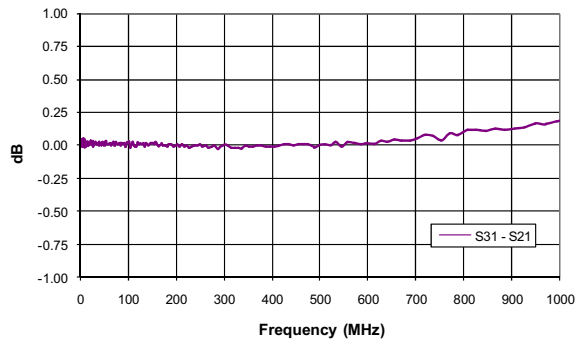

Phase Balance

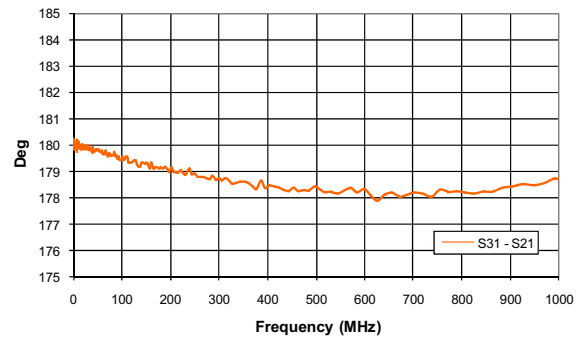

Pin Names and Description

Pin	Function	Description
1	Secondary	Output 2
2	Secondary CT	Ground
3	Secondary Dot	Output 1
4	Primary Dot	Input
5	Primary	Ground

Package Drawing - S20

Dimensions in inches (millimeters)

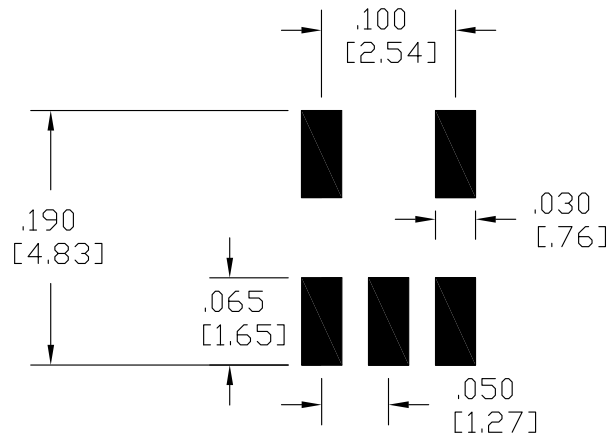
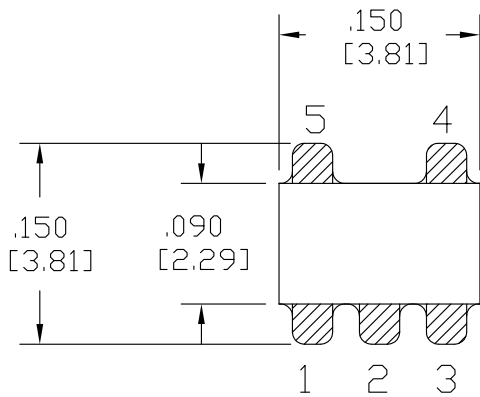

PCB FOOTPRINT

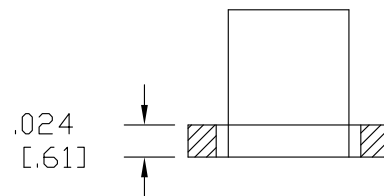
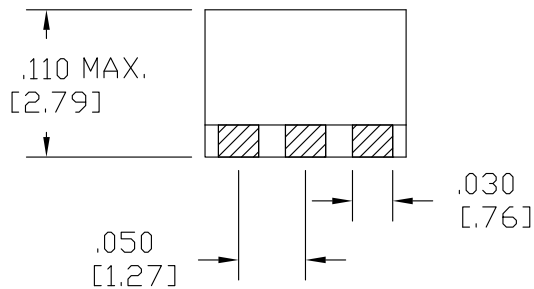

Ordering Information

Ordering Code	Description	Reel Size	Package
RFXF4513SB	5 MHz to 1000 MHz 1:1 SMT Transformer	N/A	5-Piece bag
RFXF4513SQ	5 MHz to 1000 MHz 1:1 SMT Transformer	N/A	25-Piece bag
RFXF4513SR	5 MHz to 1000 MHz 1:1 SMT Transformer	13"	100-Piece reel
RFXF4513TR13	5 MHz to 1000 MHz 1:1 SMT Transformer	13"	1000-Piece reel