



Product Description

RFMD's SXA389BZ amplifier is a high efficiency GaAs Heterojunction Bipolar Transistor (HBT) MMIC housed in low-cost surface mountable plastic package. These HBT MMICs are fabricated using molecular beam epitaxial growth technology which produces reliable and consistent performance from wafer to wafer and lot to lot. These amplifiers are specially designed for use as driver devices for infrastructure equipment in the 400 MHz to 2500 MHz cellular, ISM, WLL, PCS, WCDMA applications. Its high linearity makes it an ideal choice for multi-carrier as well as digital applications.

Optimum Technology Matching® Applied

- GaAs HBT
- GaAs MESFET
- InGaP HBT
- SiGe BiCMOS
- Si BiCMOS
- SiGe HBT
- GaAs pHEMT
- Si CMOS
- Si BJT
- GaN HEMT
- InP HBT
- RF MEMS
- LDMOS

Typical OIP₃, P1dB, Gain

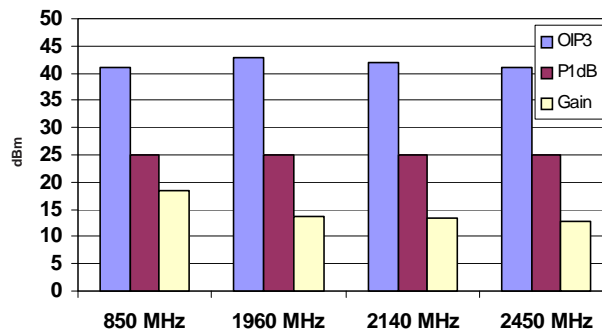

Features

- Lower R_{TH} for increased MTTF
10⁸ Hours at T_{Lead}=85°C
- On-Chip Active Bias Control, Single 5V Supply
- Excellent Linearity: +43 dBm Typ. OIP₃ at 1960 MHz
- High P_{1dB} : +25 dBm Typ.
- High Gain: +18.5 dB at 850 MHz
- Efficient: Consumes Only 575 mW

Applications

- W-CDMA, PCS, Cellular Systems
- Multi-Carrier Applications

Parameter	Specification			Unit	Condition
	Min.	Typ.	Max.		
Small Signal Gain		18.4		dB	850MHz
		13.6		dB	1960MHz
	12.5	13.5	15.0	dB	2140MHz
		12.8		dB	2450MHz
Output Power at 1dB Compression		25.0		dBm	850MHz
		25.0		dBm	1960MHz
	24.0	25.0		dBm	2140MHz
		25.0		dBm	2450MHz
Output Third Order Intercept Point		41.0		dBm	850MHz, P _{OUT} per tone = +11dBm, Tone Spacing = 1MHz
		43.0		dBm	1960MHz
	39.0	42.0		dBm	2140MHz
		41.0		dBm	2450MHz
Noise Figure		4.5		dB	850MHz
		4.8	6.3	dB	1960MHz
		5.0		dB	2140MHz
		5.7		dB	2450MHz
Input VSWR		1.2:1			850MHz
		1.3:1	2.0:1		1960MHz
		1.2:1			2140MHz
		1.2:1			2450MHz
Operating Dissipated Power		575.0		mW	
Device Operating Current	90	115	135	mA	V _{CC} =5V
Thermal Resistance		70		°C/W	junction to backside

RF MICRO DEVICES®, RFMD®, Optimum Technology Matching®, Enabling Wireless Connectivity™, PowerStar®, POLARIS™ TOTAL RADIO™ and UltimateBlue™ are trademarks of RFMD, LLC. BLUETOOTH is a trademark owned by Bluetooth SIG, Inc., U.S.A. and licensed for use by RFMD. All other trade names, trademarks and registered trademarks are the property of their respective owners. ©2006, RF Micro Devices, Inc.

Absolute Maximum Ratings

Parameter	Rating	Unit
Max Device Current (I_D)	240	mA
Max Device Voltage (V_{CC})	6	V
Max RF Input Power	100	mW
Max Dissipated Power	1500	mW
Max Junction Temperature (T_J)	165	°C
Operating Temperature Range (T_L)	-40 to + 85	°C
Max Storage Temperature	150	°C
ESD Rating - Human Body Model (HBM)	Class 1C	
Moisture Sensitivity Level	MSL 2	

Operation of this device beyond any one of these limits may cause permanent damage. For reliable continuous operation, the device voltage and current must not exceed the maximum operating values specified in the table on page one.

Bias Conditions should also satisfy the following expression:

$$I_D V_D < (T_J - T_L) / R_{TH, j-l}$$



Caution! ESD sensitive device.

Exceeding any one or a combination of the Absolute Maximum Rating conditions may cause permanent damage to the device. Extended application of Absolute Maximum Rating conditions to the device may reduce device reliability. Specified typical performance or functional operation of the device under Absolute Maximum Rating conditions is not implied.

The information in this publication is believed to be accurate and reliable. However, no responsibility is assumed by RF Micro Devices, Inc. ("RFMD") for its use, nor for any infringement of patents, or other rights of third parties, resulting from its use. No license is granted by implication or otherwise under any patent or patent rights of RFMD. RFMD reserves the right to change component circuitry, recommended application circuitry and specifications at any time without prior notice.



RFMD Green: RoHS compliant per EU Directive 2002/95/EC, halogen free per IEC 61249-2-21, < 1000ppm each of antimony trioxide in polymeric materials and red phosphorus as a flame retardant, and <2% antimony in solder.

Recommended Mounting Configuration for Optimum RF and Thermal Performance

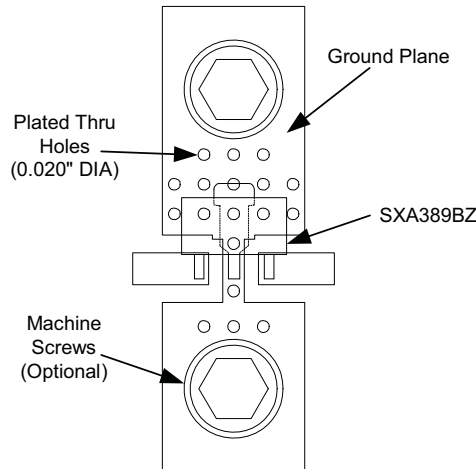

850MHz Application Circuit Data, $V_{CC}=5V$, $I_D=115mA$ (Tuned for Output IP3)

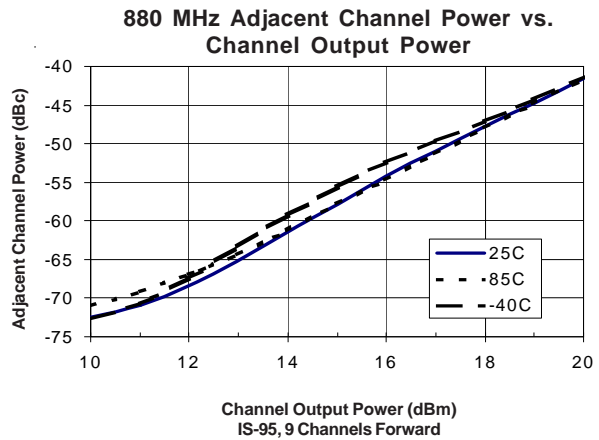
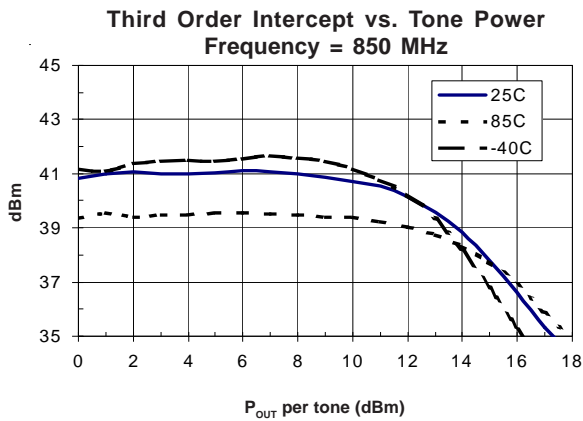
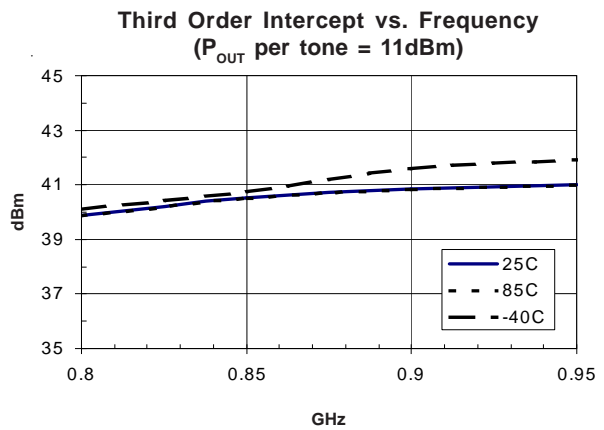
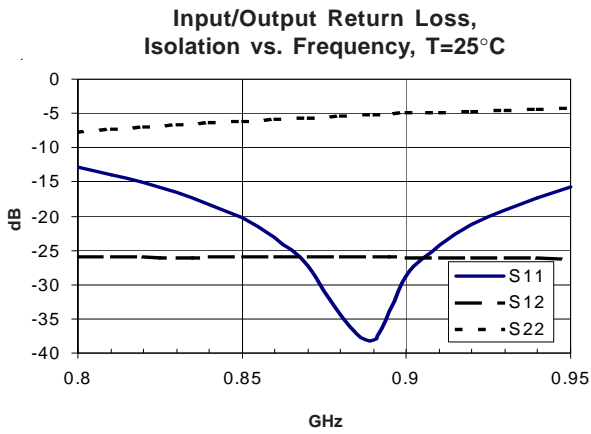
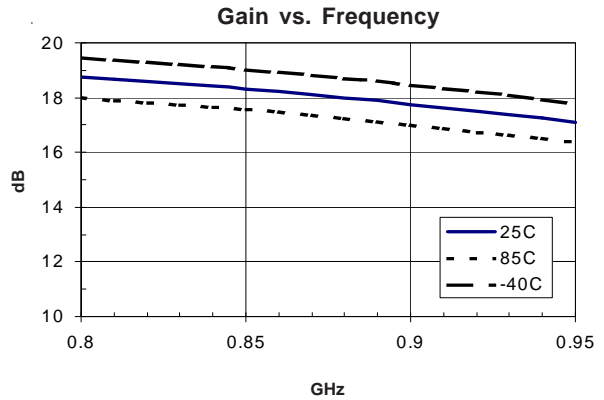
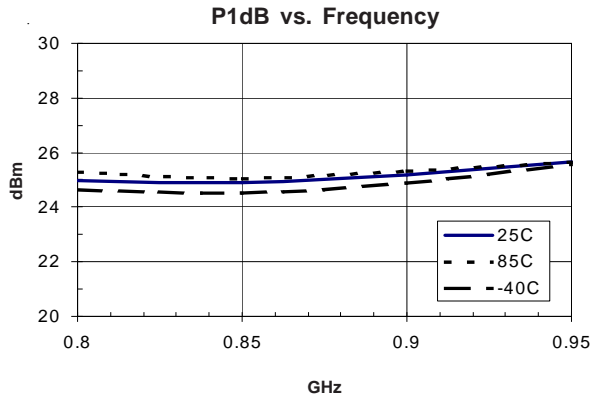

1960MHz Application Circuit Data, $V_{CC}=5V$, $I_D=115mA$ (Tuned for Output IP3)

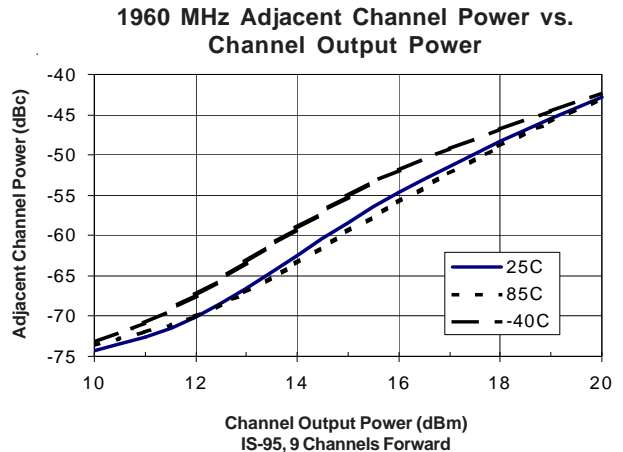
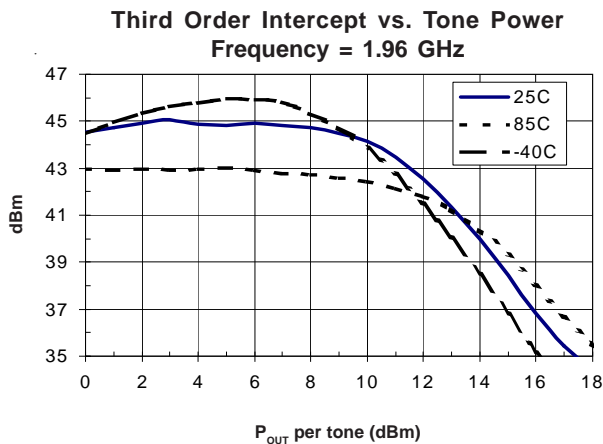
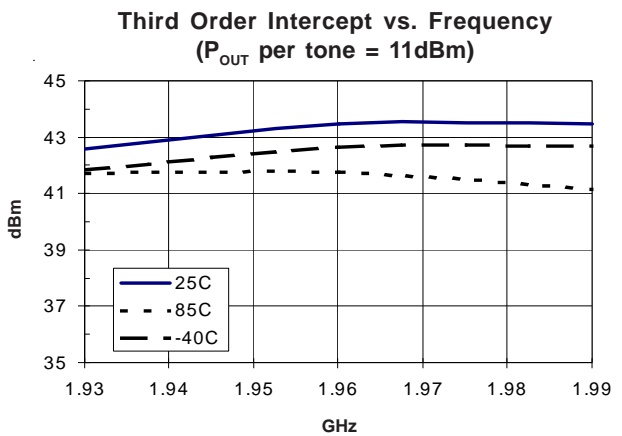
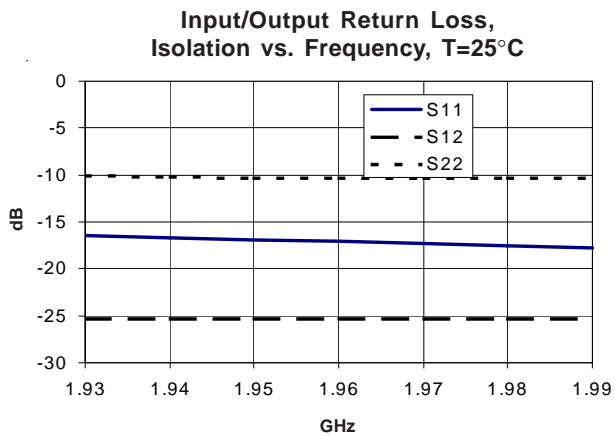
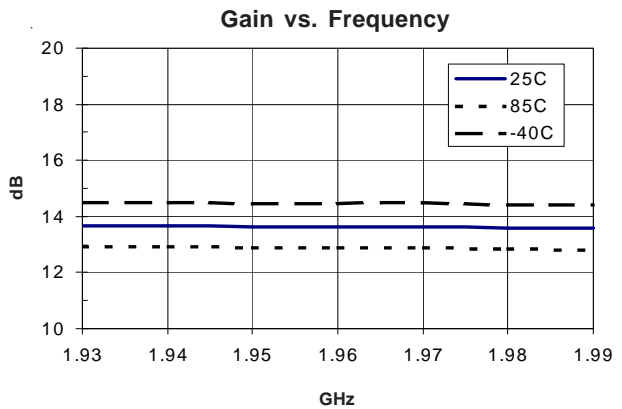
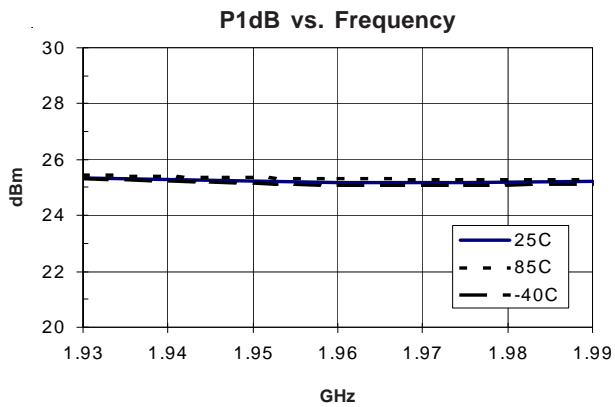

2140MHz Application Circuit Data, $V_{CC}=5V$, $I_D=115mA$ (Tuned for Output IP3)

P1dB vs. Frequency

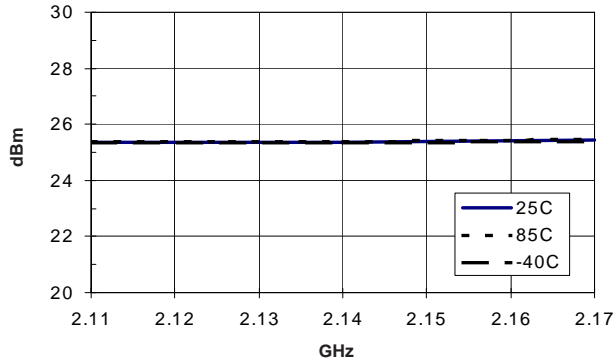

Gain vs. Frequency

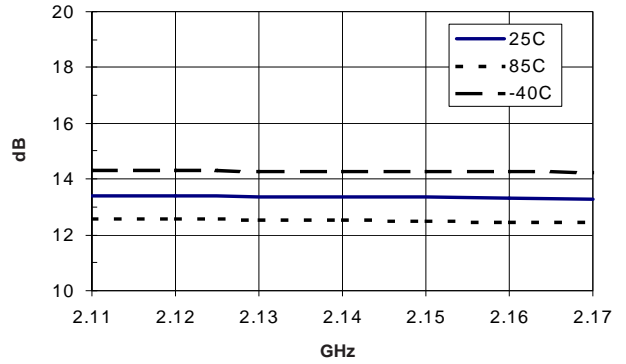

Input/Output Return Loss, Isolation vs. Frequency, T=25°C

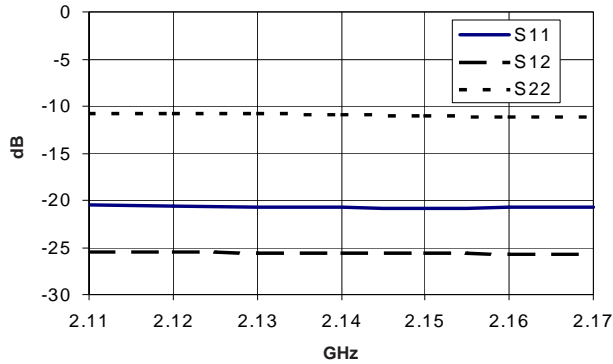

Third Order Intercept vs. Frequency (P_{OUT} per tone = 11dBm)

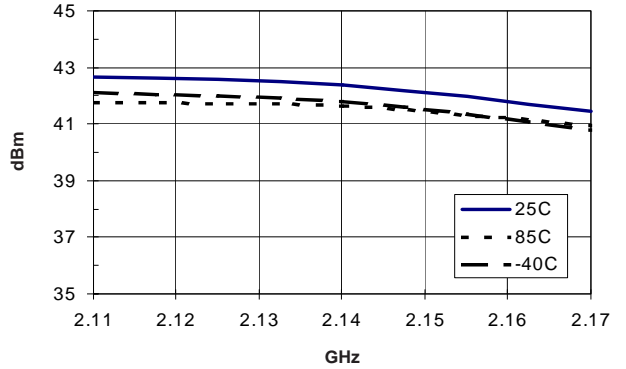

Third Order Intercept vs. Tone Power Frequency = 2.14 GHz

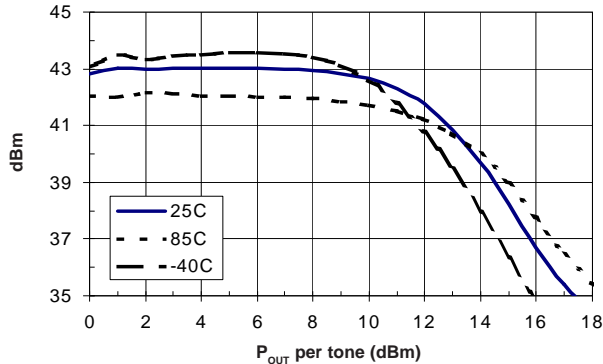

2140 MHz Adjacent Channel Power vs. Channel Output Power

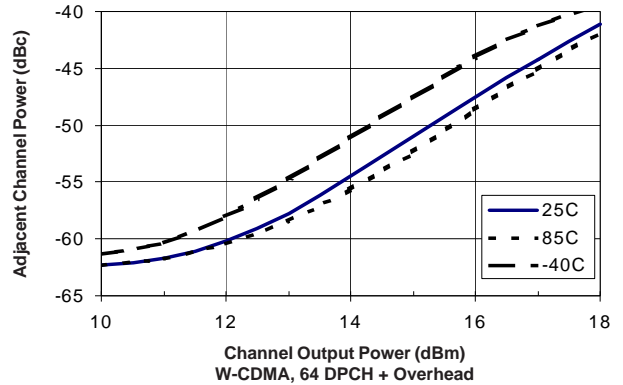

2450MHz Application Circuit Data, $V_{CC}=5V$, $I_D=115mA$ (Tuned for Output IP3)

P1dB vs. Frequency

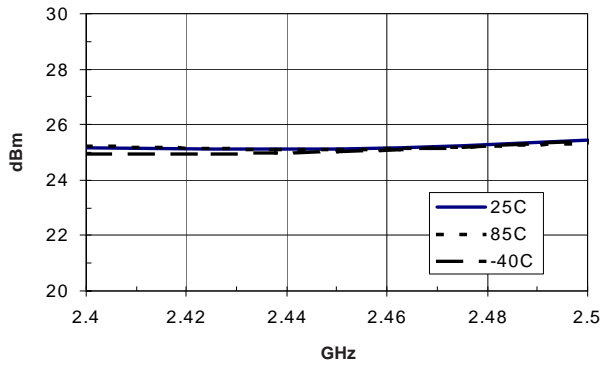

Gain vs. Frequency

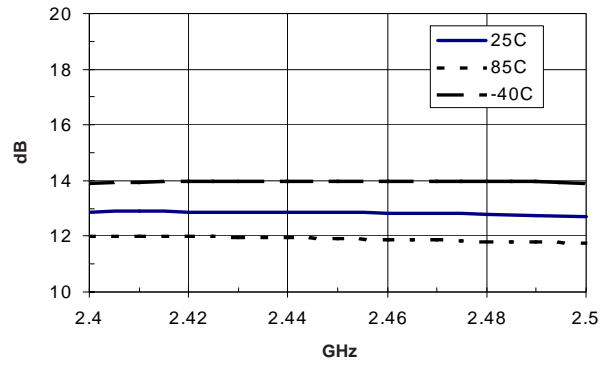

Input/Output Return Loss, Isolation vs. Frequency, T=25°C

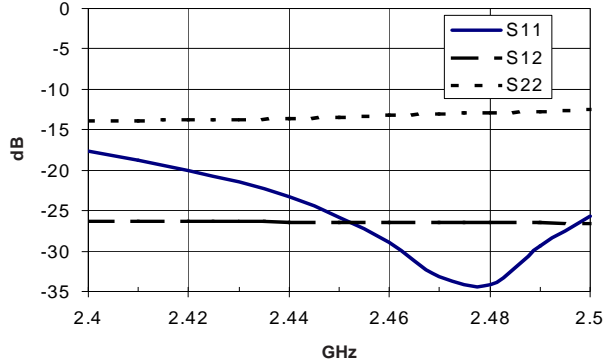

Third Order Intercept vs. Frequency (P_{OUT} per tone = 11dBm)

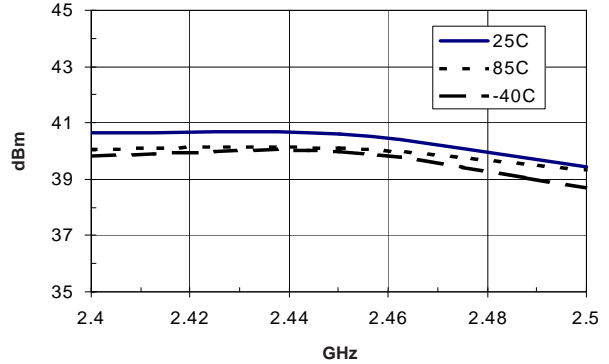

Third Order Intercept vs. Tone Power Frequency = 2.45 GHz

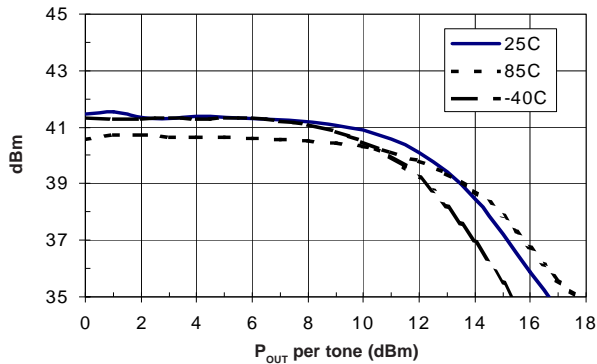

Pin	Function	Description
1	Base	Base pin
2	GND and Emitter	Connection to ground. Use via holes to reduce lead inductance. Place via holes as close to ground leads as possible.
3	Collector	Collector pin
4	GND and Emitter	Connection to ground. Use via holes to reduce lead inductance. Place via holes as close to ground leads as possible.

Suggested Pad Layout

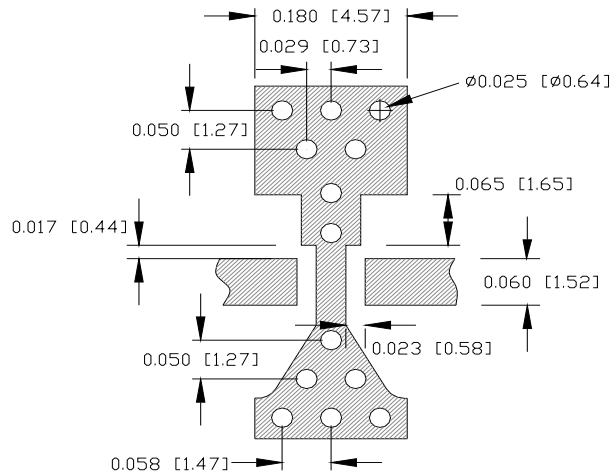

Package Drawing

Dimensions in inches (millimeters)

Refer to drawing posted at www.rfmd.com for tolerances.

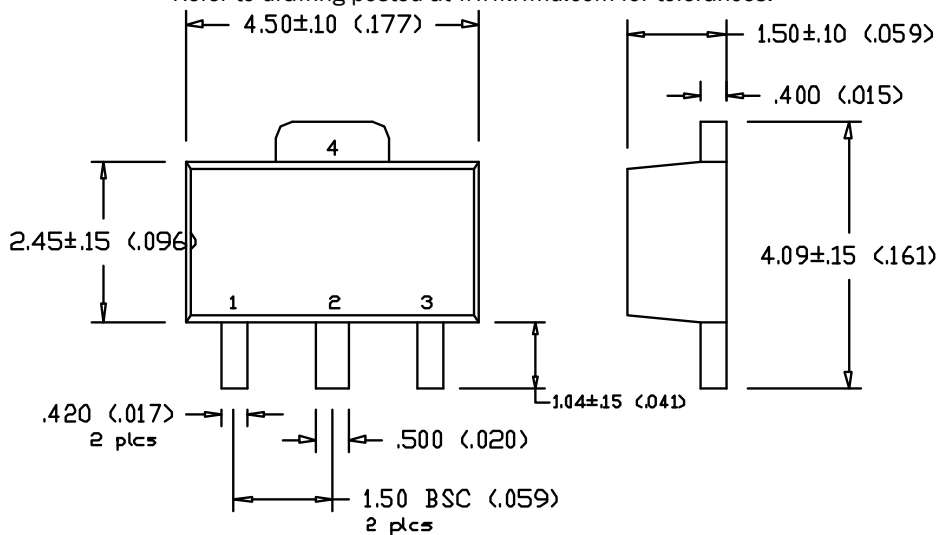

850MHz Application Schematic

Application Schematic for 850 MHz, 2450 MHz

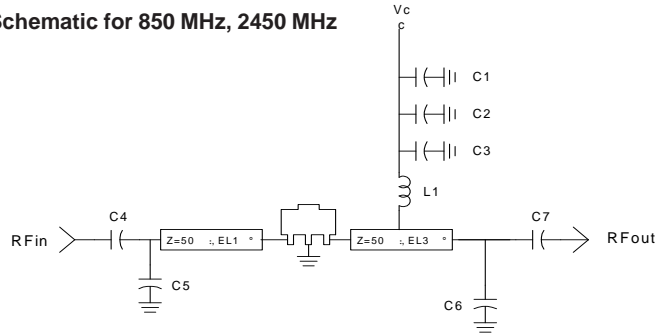

Ref. Des.	Vendor Series	850 MHz	2450 MHz
C1	Matsuo 267M3502104K	0.1uF 10%	0.1uF 10%
C2	Rohm MCH18	1000pF 5%	1000pF 5%
C3, C7	Rohm MCH18	47pF 5%	22pF 5%
C4	Rohm MCH18	47pF 5%	1.2pF ±0.25pF
C5	Rohm MCH18	5.6pF ±0.25pF	-

Ref. Des.	Vendor Series	850 MHz	2450 MHz
C6	Rohm MCH18	3.9pF ±0.25pF	1.0pF ±0.25pF
C6 Position		1	2
L1	Toko LL1608-FS	33nH 5%	15nH 5%
EL1		15	76
EL3		7.2	31.5

850MHz Evaluation Board Layout

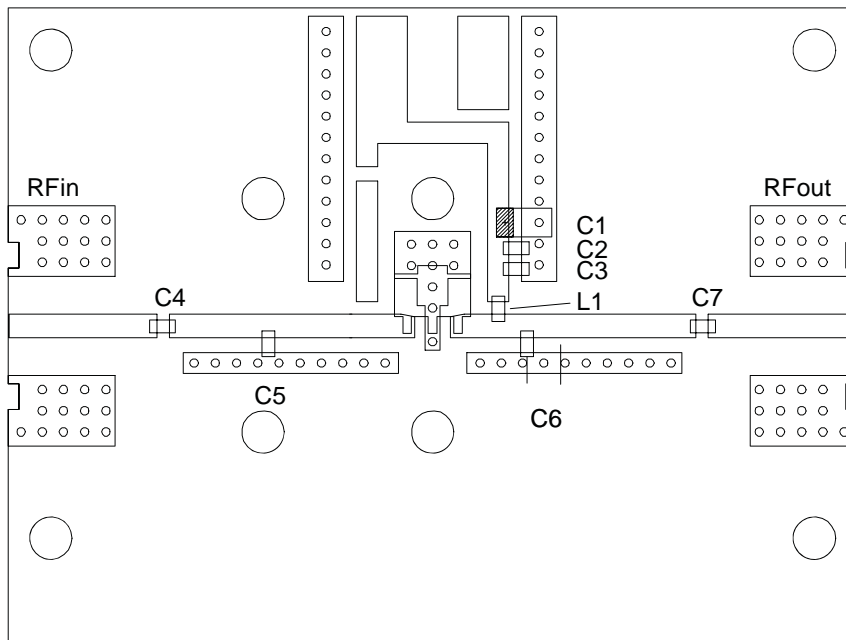

1960MHz and 2140MHz Application Schematic

Application Schematic for 1960 MHz, 2140 MHz

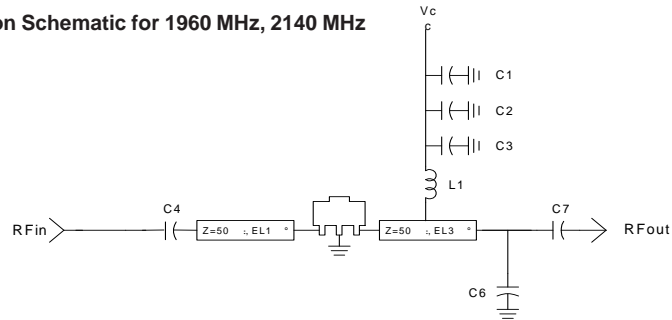

Ref. Des.	Vendor Series	1960/2140 MHz
C1	Matsuo 267M3502104K	0.1 μ F 10%
C2	Rohm MCH18	1000pF 5%
C3, C7	Rohm MCH18	22pF 5%
C4	Rohm MCH18	2.2pF ± 0.25 pF
C5	Rohm MCH18	-

Ref. Des.	Vendor Series	1960/2140 MHz
C6	Rohm MCH18	1.0pF ± 0.25 pF
L1	Toko LL1608-FS	18nH 5%
EL1		35
EL3		30

1960MHz and 2140MHz Evaluation Board Layout

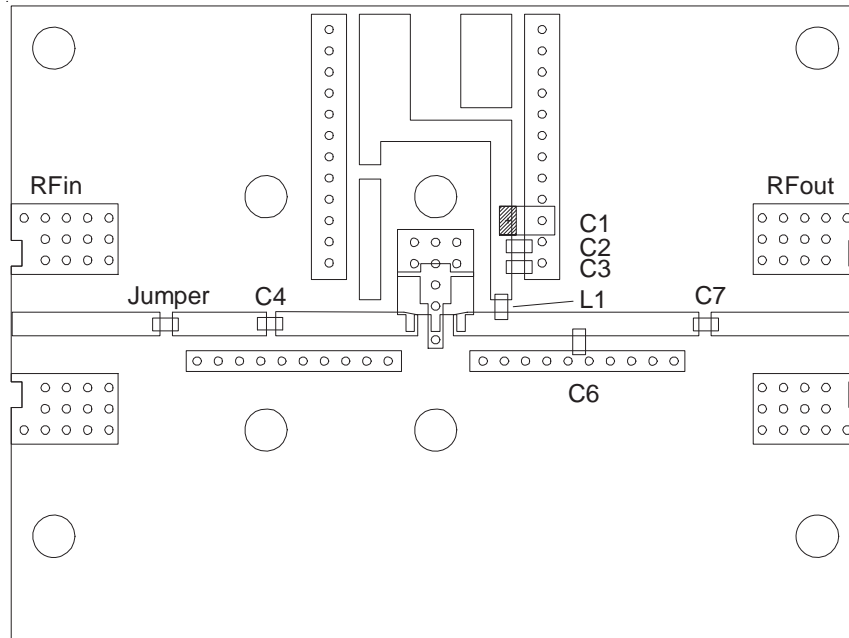

Part Identification

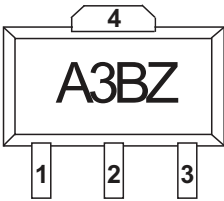

Alternate marking: "SXA389BZ" on line one with Trace Code on line two.

Ordering Information

Ordering Code	Description
SXA389BZ	7" Reel with 1000 pieces
SXA389BZSQ	Sample Bag with 25 pieces
SXA389BZSR	7" Reel with 100 pieces
SXA389BZPCK1	800MHz PCBA with 5 piece Sample Bag
SXA389BZPCK2	2440MHz PCBA with 5 piece Sample Bag