



Product Description

RFMD's SZP-5026Z is a high-linearity, single-stage, class AB Heterojunction Bipolar Transistor (HBT) power amplifier. It is designed with InGaP-on-GaAs device technology and fabricated with MOCVD for an ideal combination of low cost and high reliability. This product is specifically designed for use as a driver or final stage power amp for 802.16 equipment in the 4.9GHz to 5.9GHz bands. It is pre-matched on both ports to simplify external application circuit design. It features an input power detector, on/off power control, ESD protection, excellent overall robustness, and a hand reworkable and thermally enhanced surface-mount SOF-26 package.

Optimum Technology Matching® Applied

- GaAs HBT
- GaAs MESFET
- InGaP HBT
- SiGe BiCMOS
- Si BiCMOS
- SiGe HBT
- GaAs pHEMT
- Si CMOS
- Si BJT
- GaN HEMT
- RF MEMS

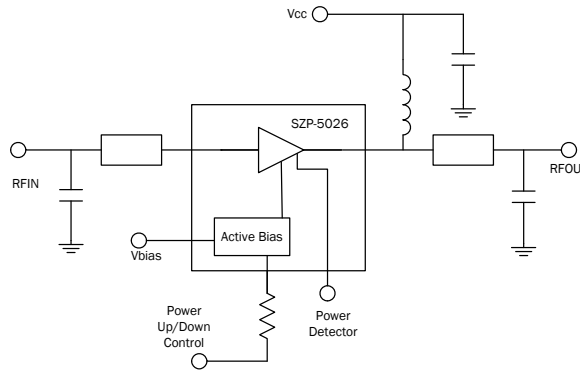

Features

- P_{1dB} = 33dBm at 5V
- 802.11a 54 Mb/s Class AB Performance
- P_{OUT} = 25dBm at 2.5% EVM, 5.9GHz, 5V, 680mA
- On-Chip Input Power Detector
- Internally Prematched Input and Output
- Proprietary Low Thermal Resistance Package
- Power Up/Down Control < 1μs

Applications

- 802.16 WiMAX Driver or Output Stage
- 5 GHz 802.11 WiFi and ISM Applications

Parameter	Specification			Unit	Condition
	Min.	Typ.	Max.		
Frequency of Operation	4900		5900	MHz	
Output Power at 1dB Compression		32.5		dBm	5.9GHz
Small Signal Gain		8.8		dBm	5.9GHz
EVM at 25dBm Output Power		2.5		%	5.9GHz, 802.11a 54 Mb/s
Third Order Suppression		-45.0		dBc	5.9GHz, P _{OUT} = 23dBm per tone
Noise Figure		5.4		dB	5.9GHz
Worst Case Input Return Loss		19.0		dB	5.7GHz to 5.9GHz
Worst Case Output Return Loss		13.0		dB	5.7GHz to 5.9GHz
Output Voltage Range	0.8		2.0	V	P _{OUT} = 10dBm to 33dBm
Quiescent Current		602		mA	V _{CC} = 5V
Power Up Control Current		2.7		mA	V _{PC} = 5V
V _{CC} Leakage Current			100	μA	V _{CC} = 5V, V _{PC} = 0V
Thermal Resistance		14.0		°C/W	Junction-to-Lead

Test Conditions: Z₀ = 50Ω, V_{CC} = 5V, I_Q = 602mA, T_{BP} = 30°C

Absolute Maximum Ratings

Parameter	Rating	Unit
VC1 Collector Bias Current (I_{VC1})	1500	mA
Device Voltage (V_D)*	6.0	V
Power Dissipation (P_{DISS})	6	W
Operating Lead Temperature (T_L)	-40 to +85	°C
**Max RF output Power for 50Ω continuous long term operation	30	dBm
Max Modulated (***)OFDM RF Input Power for 50Ω output load	28	dBm
Max Modulated (***)OFDM RF Input Power for 10:1 VSWR output load	21	dBm
Storage Temperature Range	-40 to +150	°C
Operating Junction Temperature (T_J)	+150	°C
ESD Human Body Model	1000	V
Moisture Sensitivity Level	MSL 1	

*No RF Drive

**With specified application circuit

***Modulation schemes include 802.11a/g, 802.16

Operation of this device beyond any one of these limits may cause permanent damage. For reliable continuous operation, the device voltage and current must not exceed the maximum operating values specified in the table on page one.

Bias Conditions should also satisfy the following expression:

$$I_D V_D < (T_J - T_L) / R_{TH, J-I}$$



Caution! ESD sensitive device.

Exceeding any one or a combination of the Absolute Maximum Rating conditions may cause permanent damage to the device. Extended application of Absolute Maximum Rating conditions to the device may reduce device reliability. Specified typical performance or functional operation of the device under Absolute Maximum Rating conditions is not implied.

RoHS status based on EUDirective2002/95/EC (at time of this document revision).

The information in this publication is believed to be accurate and reliable. However, no responsibility is assumed by RF Micro Devices, Inc. ("RFMD") for its use, nor for any infringement of patents, or other rights of third parties, resulting from its use. No license is granted by implication or otherwise under any patent or patent rights of RFMD. RFMD reserves the right to change component circuitry, recommended application circuitry and specifications at any time without prior notice.

Typical 5V Performance with Appropriate Application Circuit ($V_{CC}=5V$, $I_{CQ}=602mA$, 802.11a 54Mb/s)

Parameter	Units	5.15GHz	5.35GHz	5.7GHz	5.9GHz
Gain @ $P_{OUT}=26dBm$	dB	8.8	9.0	9.4	8.8
P1dB	dBm	32.7	32.2	33.2	32.5
P_{OUT} @ 2.5% EVM	dBm	25.3	25.1	25.3	25.0
Current @ P_{OUT} 2.5% EVM	mA	632	631	670	670
Input Return Loss	dB	10	13	19	19
Output Return Loss	dB	15	13	15	13

Simplified Device Schematic

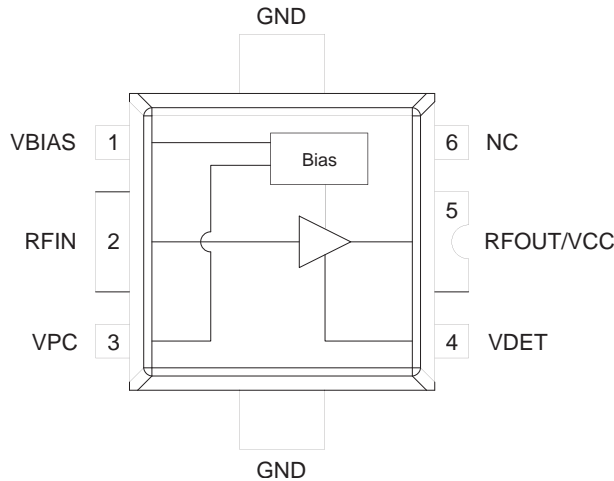

5.15GHz to 5.35GHz Application Circuit Data ($V_{CC}=V_{PC}=5.0V$, $I_Q=563mA$)

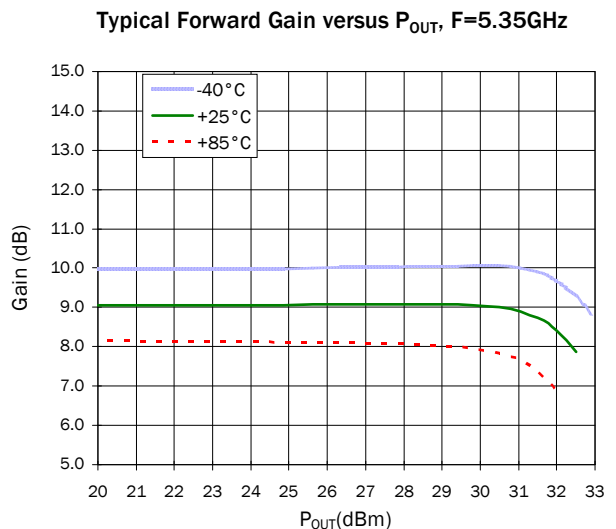
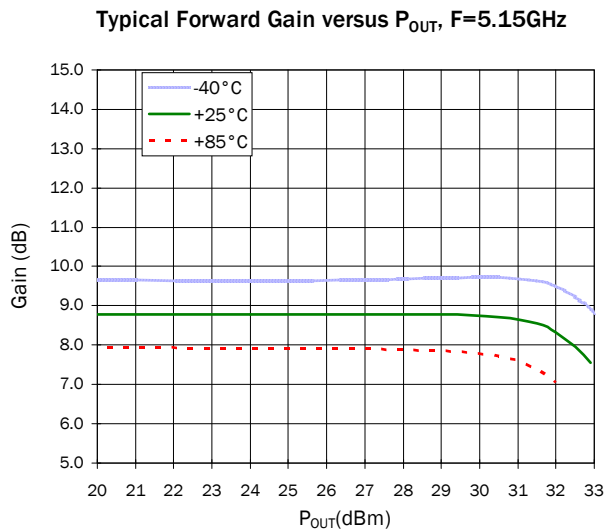
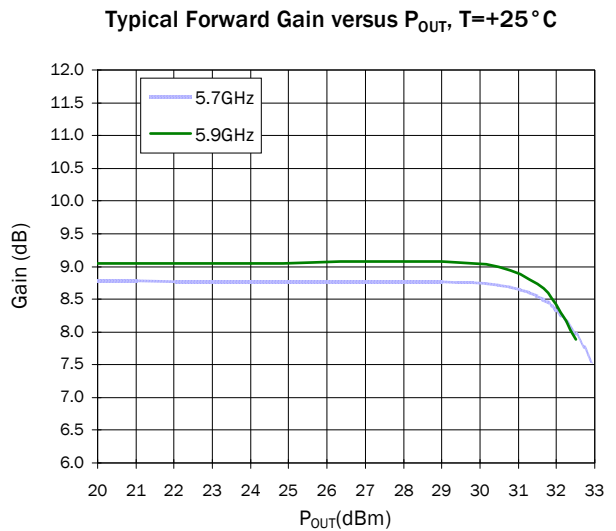
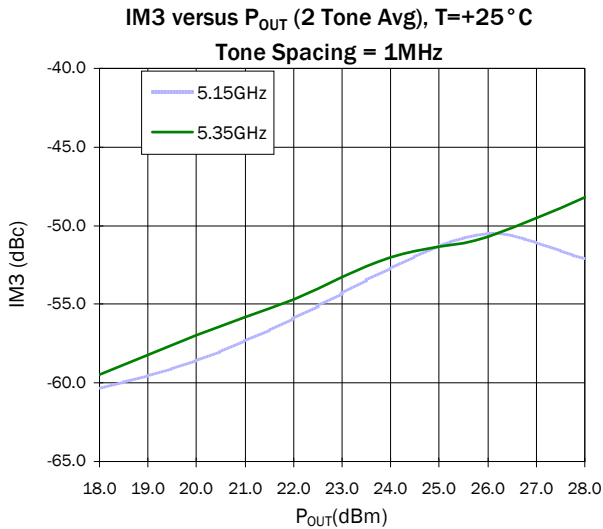
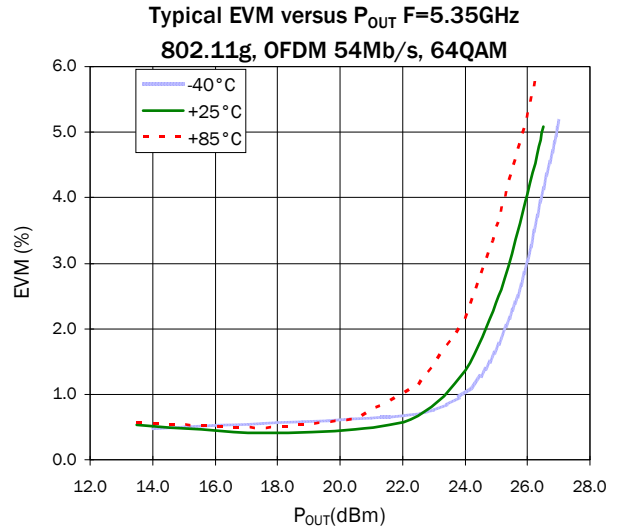
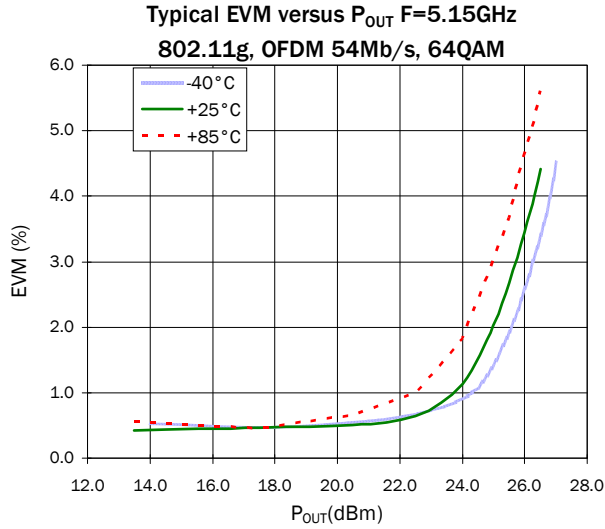

5.15GHz to 5.35GHz Application Circuit Data ($V_{CC}=V_{PC}=5.0V$, $I_Q=563mA$)

Narrowband S11 - Input Return Loss

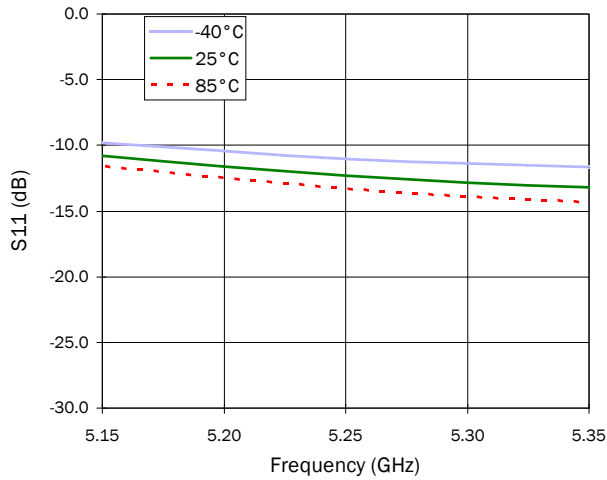

Narrowband S21 - Forward Gain

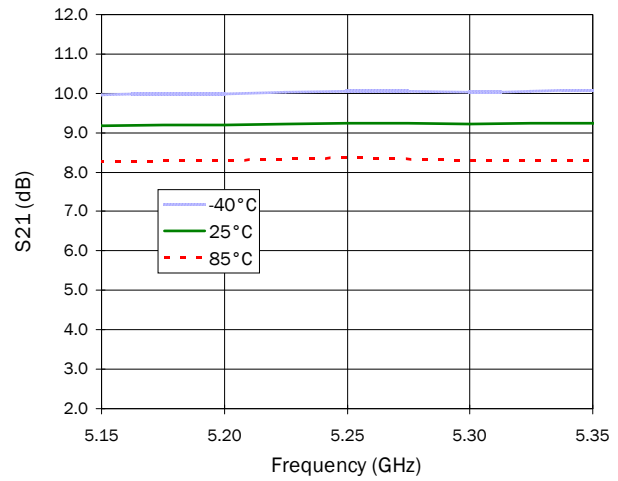

Narrowband S12 - Reverse Isolation

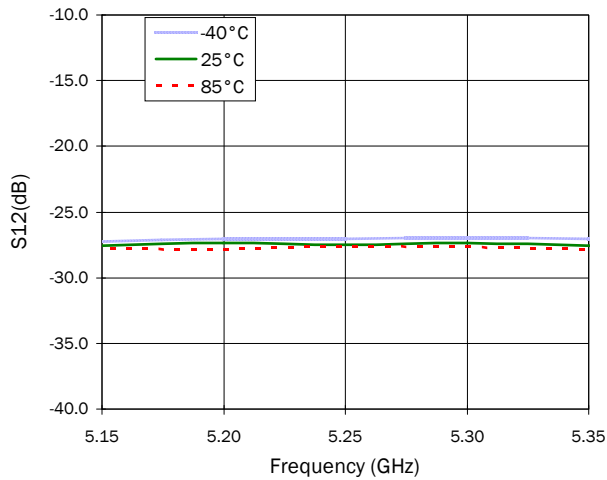

Narrowband S22 - Output Return Loss

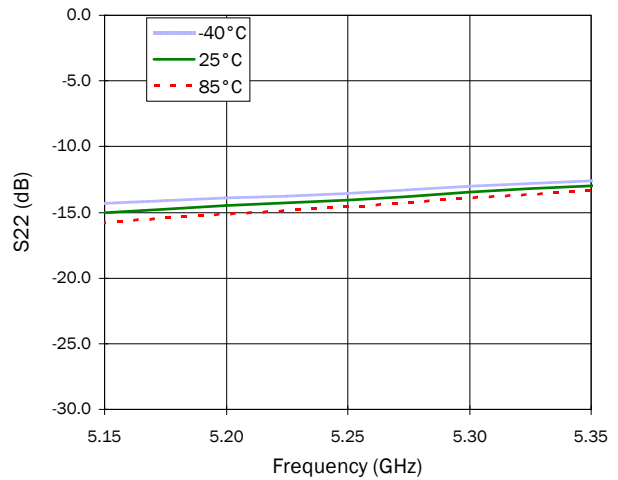

5.15GHz to 5.35GHz Application Circuit Data ($V_{CC}=V_{PC}=5.0V$, $I_Q=563mA$)

Broadband S11 - Input Return Loss

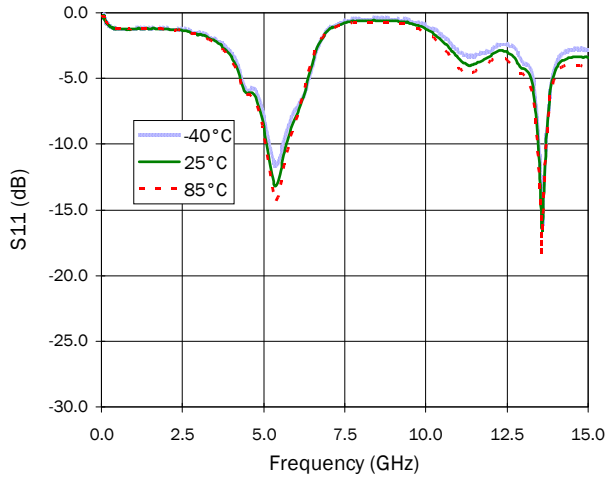

Broadband S21 - Forward Gain

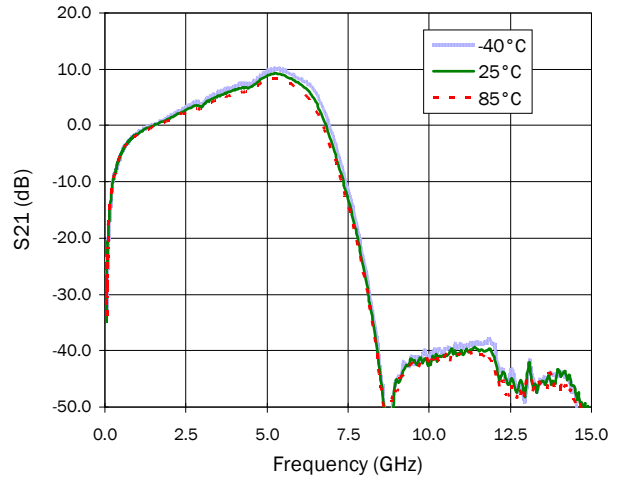

Broadband S12 - Reverse Isolation

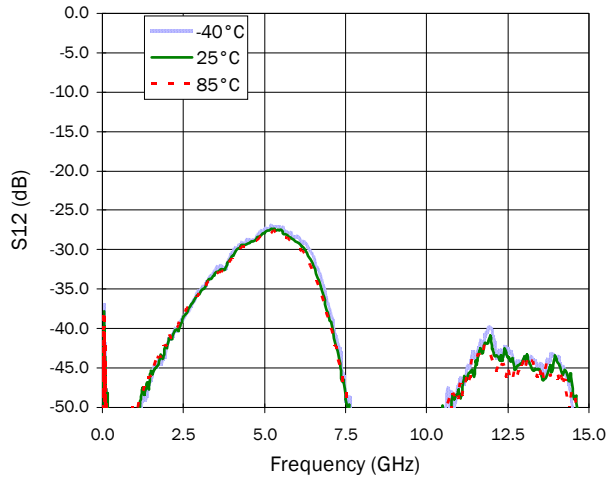

Broadband S22 - Output Return Loss

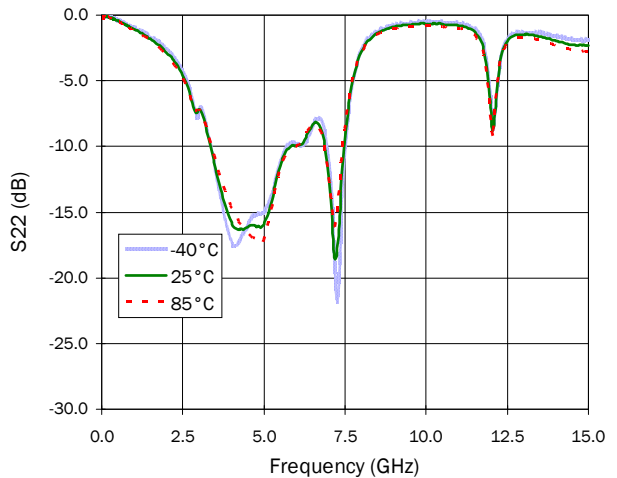

5.15GHz to 5.35GHz Application Circuit Data ($V_{CC}=V_{PC}=5.0V$, $I_Q=563mA$)

DC Supply Current versus P_{OUT} , $T=+25^\circ C$

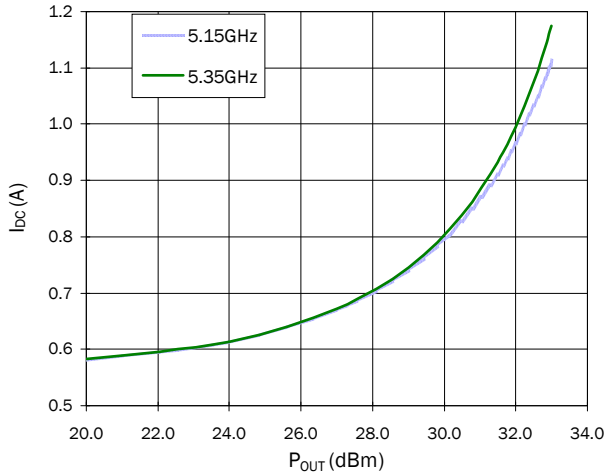

Noise Figure F=5.15GHz to 5.35GHz

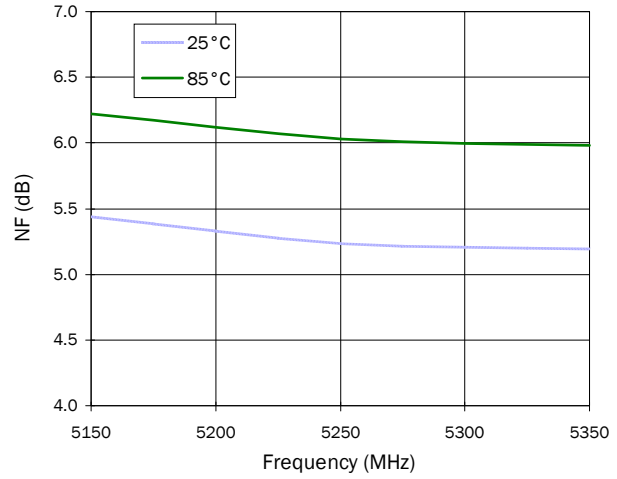

RF Power (V_{DET}) versus P_{OUT} F=5.15GHz

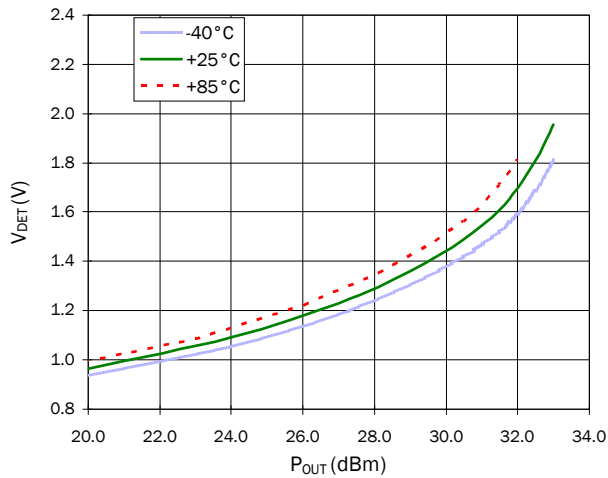

RF Power (V_{DET}) versus P_{OUT} F=5.35GHz

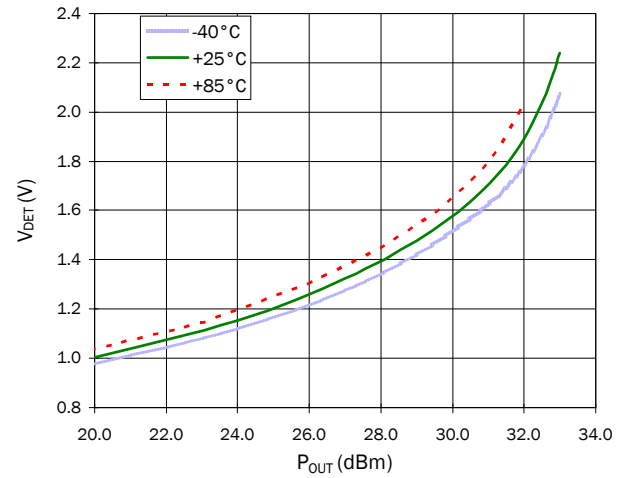

5.7GHz to 5.9GHz Application Circuit Data ($V_{CC}=V_{PC}=5.0V$, $I_Q=602mA$)

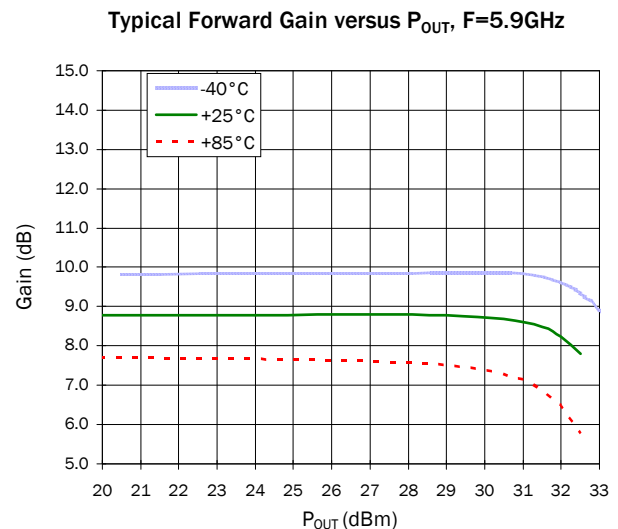
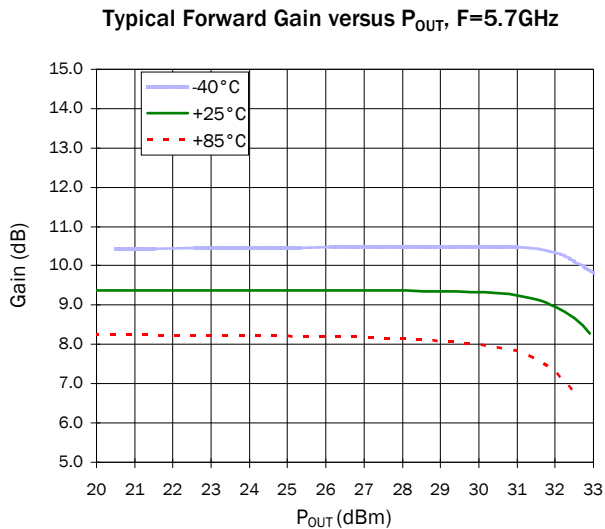
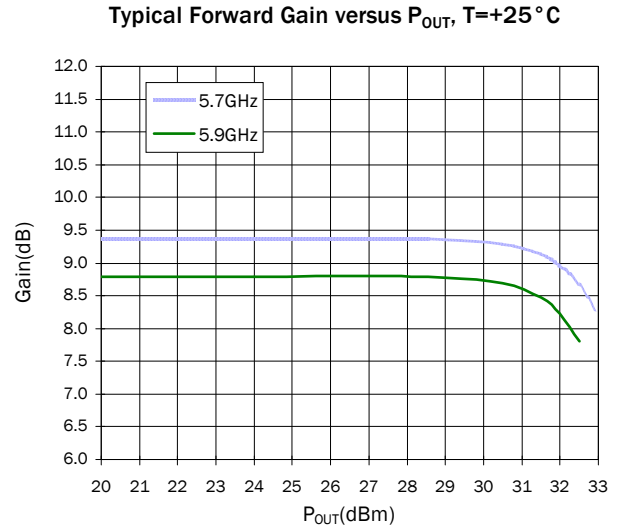
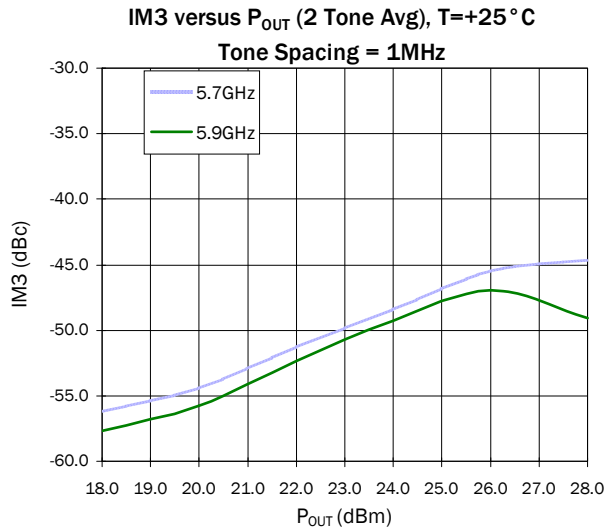
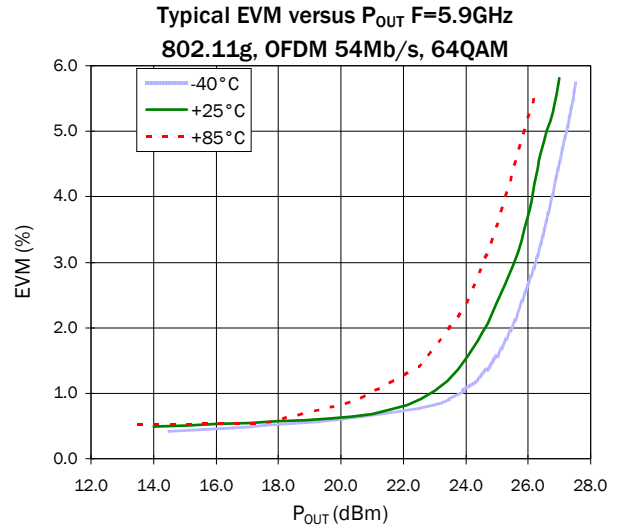
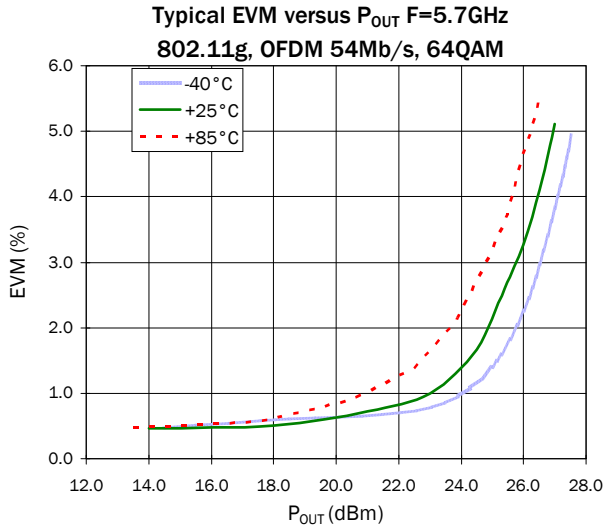

5.7GHz to 5.9GHz Application Circuit Data ($V_{CC}=V_{PC}=5.0V$, $I_Q=602mA$)

Narrowband S11 - Input Return Loss

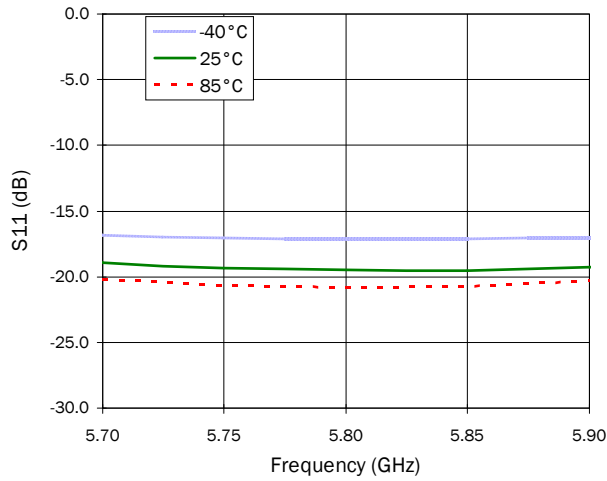

Narrowband S21 - Forward Gain

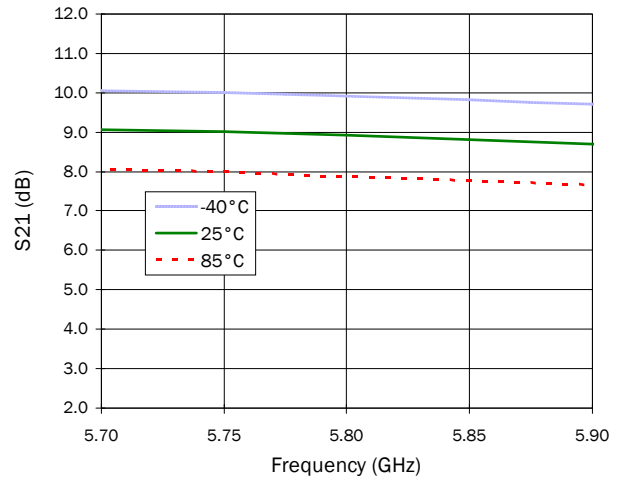

Narrowband S12 - Reverse Isolation

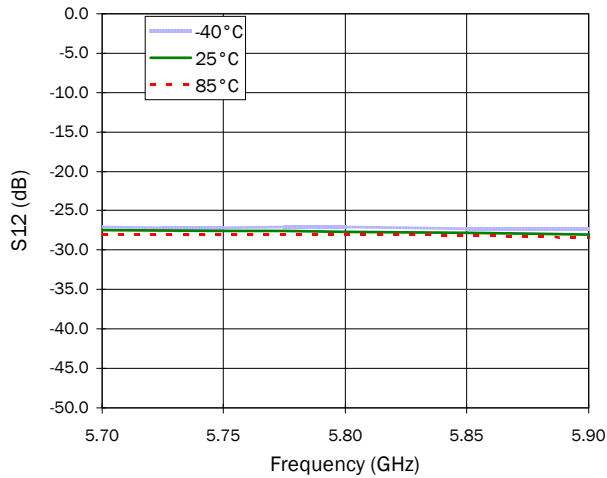

Narrowband S22 - Output Return Loss

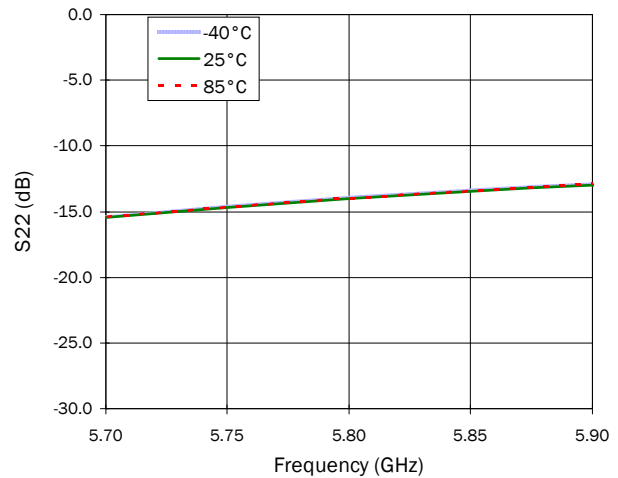

5.7GHz to 5.9GHz Application Circuit Data ($V_{CC}=V_{PC}=5.0V$, $I_Q=602mA$)

Broadband S11 - Input Return Loss

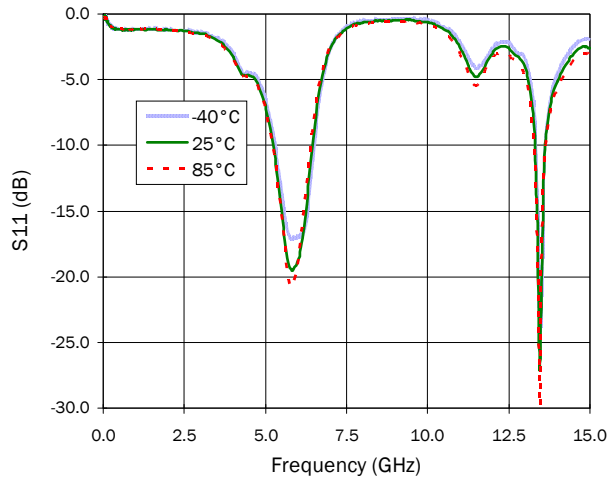

Broadband S21 - Forward Gain

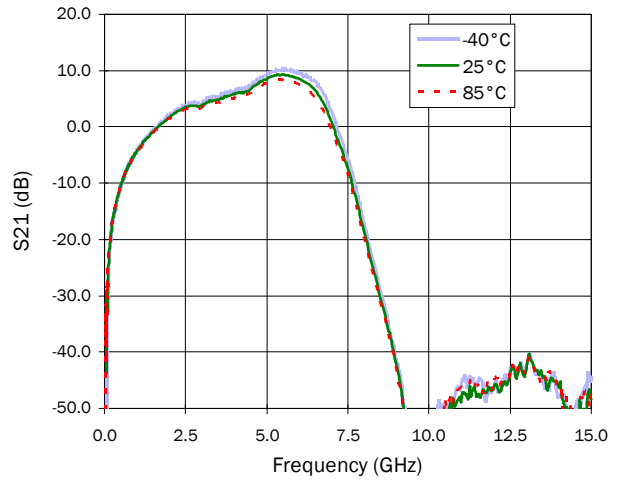

Broadband S12 - Reverse Isolation

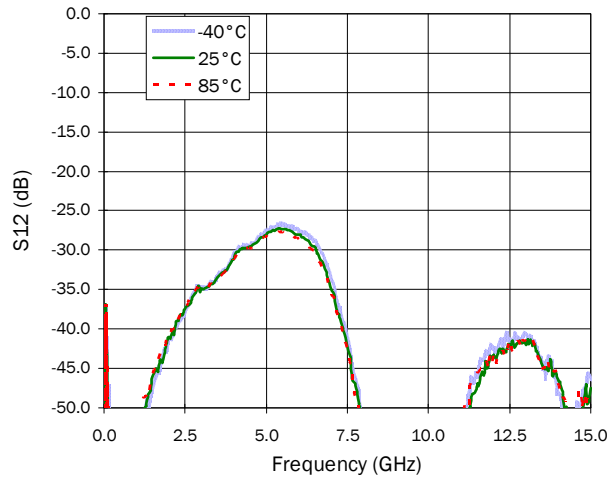

Broadband S22 - Output Return Loss

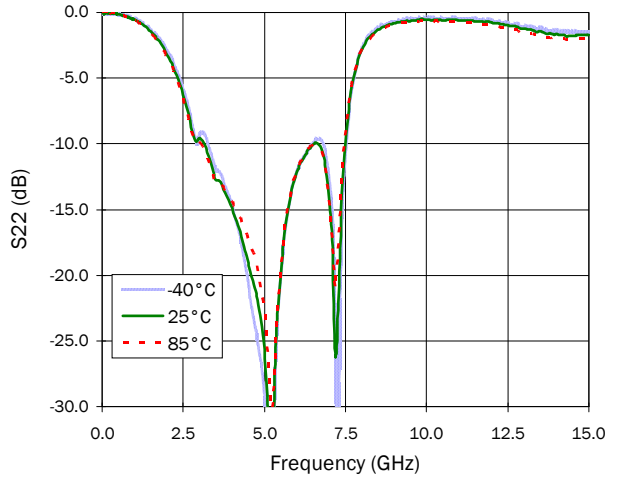

5.7GHz to 5.9GHz Application Circuit Data ($V_{CC}=V_{PC}=5.0V$, $I_Q=602mA$)

DC Supply Current versus P_{OUT} , F=5.9GHz

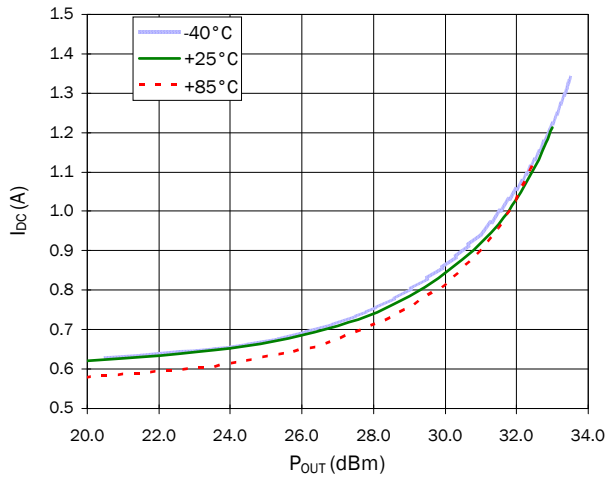

Noise Figure F=5.7GHz to 5.9GHz

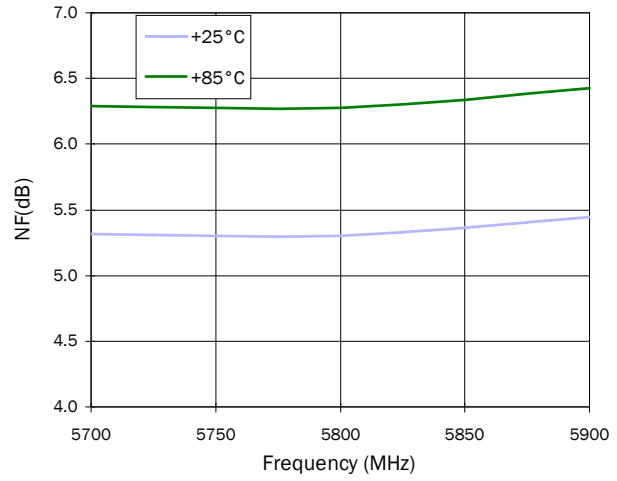

RF Power (V_{DET}) versus P_{OUT} F=5.7GHz

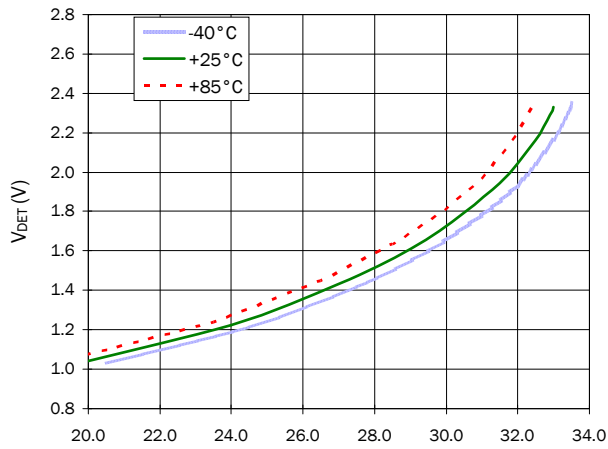

RF Power (V_{DET}) versus P_{OUT} F=5.9GHz

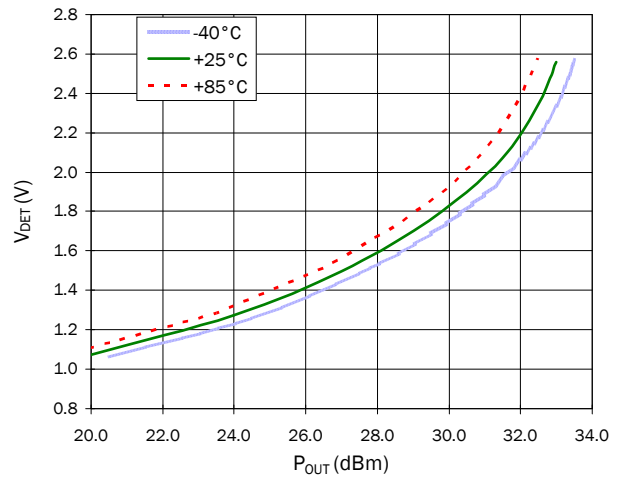

Evaluation Board Schematic

5.15GHz to 5.35GHz Evaluation Board Schematic for $V_{++}=V_{CC}=V_{PC}=5.0V$, $I_Q=563mA$

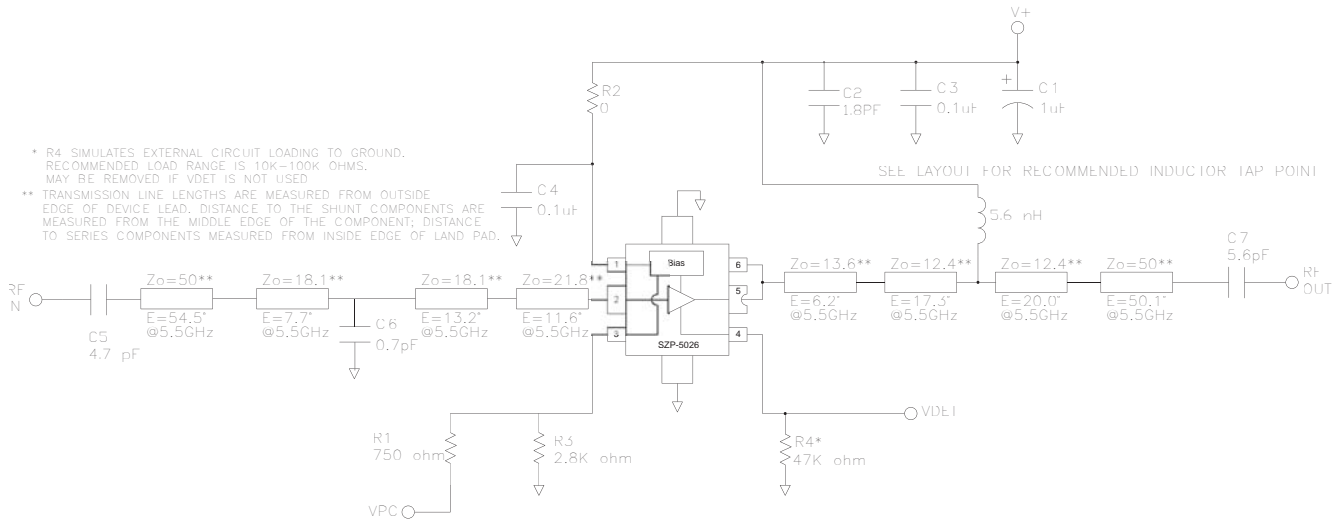

Evaluation Board Layout and Bill of Materials

5.15GHz to 5.35GHz Evaluation Board Layout for $V_{+}=V_{CC}=V_{PC}=5.0V$, $I_Q=563mA$

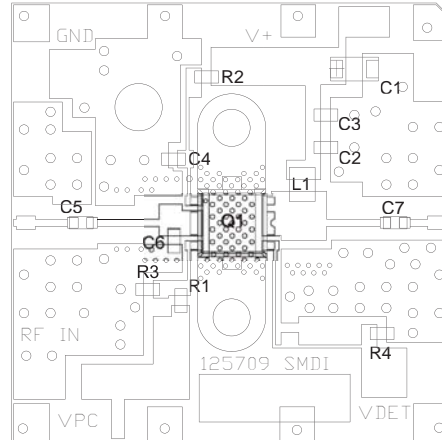

PCB Notes: Do not use less than the recommended number of via holes under the device ground paddle. RF layers thicker than 0.020 inches (0.5mm) not recommended.

Bill of Materials

DESG	Description	Notes
Q1	SZP-5026Z	S0F-26
R1	750 Ω , 0603 1%	0402 may be used.
R2	0 Ω , 0603	0402 may be used.
R3	2.80K Ω , 0603 1%	0402 may be used.
R4	47K Ω , 0603	0402 may be used.
C1	1 μ F 16V MLCC CAP	Tantulum ok for EVM performance. Use MLCC type for best IM3 levels.
C2	1.8pF CAP, 0603	NPO, ROHM MCH185A1R8DK or equiv.
C3, 4	0.1 μ F CAP, 0603	X7R 0402 ok, ROHM MCH182CN104K or equiv.
C5	4.7 pF CAP, 0603	NPO, low ESR, ATC 600S4R7CW250 or equiv.
C6	0.7 pF CAP, 0603	NPO, low ESR, ATC 600S0R7CW250 or equiv.
C7	5.6 pF CAP, 0603	NPO, low ESR, ATC 600S5R6CW250 or equiv.
L1	5.6nH IND, 0805	Coilcraft 0805-HQ-5N6XJBB

Evaluation Board Schematic

5.7 GHz to 5.9 GHz Evaluation Board Schematic for $V^+ = V_{CC} = V_{PC} = 5.0V$, $I_Q = 602mA$

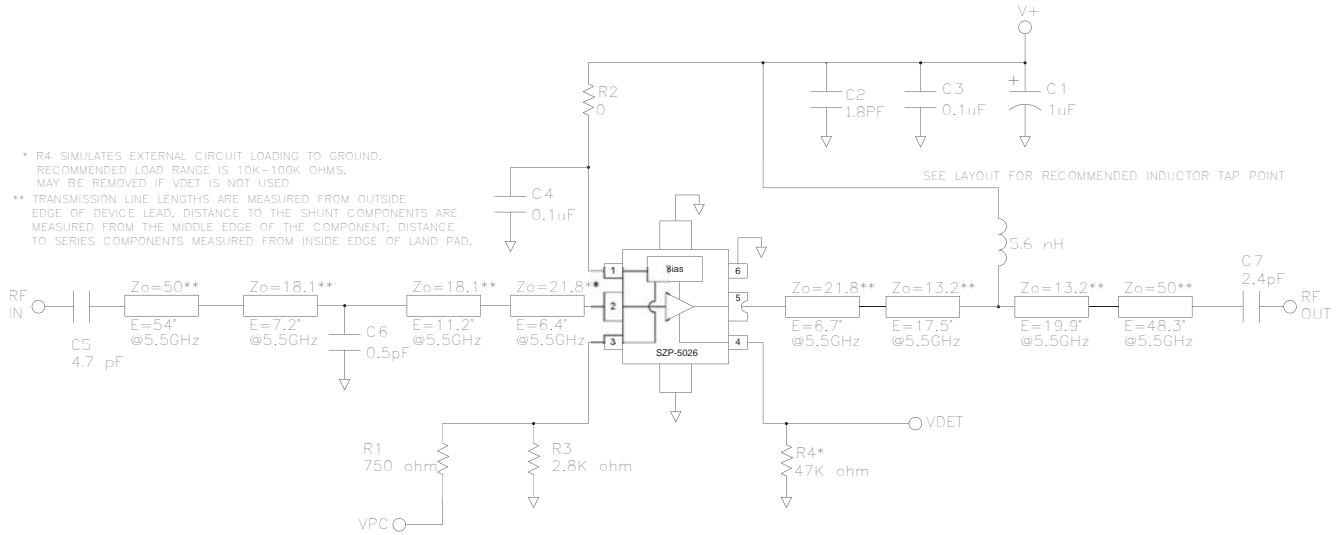

Evaluation Board Layout and Bill of Materials

5.7 GHz to 5.9GHz Evaluation Board Layout for $V_{CC}=V_{PC}=5.0V$, $I_Q=602mA$

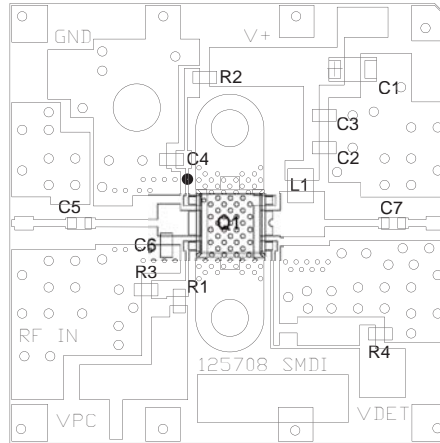

Bill of Materials

DESG	Description	Notes
Q1	SZP-5026Z	SOF-26
R1	750 Ω , 0603 1%	0402 may be used.
R2	0 Ω , 0603	0402 may be used.
R3	2.80K Ω , 0603 1%	0402 may be used.
R4	47K Ω , 0603	0402 may be used.
C1	1 μ F 16V MLCC CAP	Tantalum ok for EVM performance. Use MLCC type for best IM3 levels.
C2	1.8pF CAP, 0603	NPO, ROHM MCH185A1R8DK or equiv.
C3, 4	0.1 μ F CAP, 0603	X7R 0402 ok, ROHM MCH182CN104K or equiv.
C5	4.7 pF CAP, 0603	NPO, low ESR, ATC 600S4R7CW250 or equiv.
C6	0.5 pF CAP, 0603	NPO, low ESR, ATC 600S0R5CW250 or equiv.
C7	2.4 pF CAP, 0603	NPO, low ESR, ATC 600S2R4CW250 or equiv.
L1	5.6nH IND, 0805	Coilcraft 0805-HQ-5N6XJBB

Pin	Function	Description
1	VBIAS	This is the supply voltage for the active bias circuit.
2	RF IN	This is the RF input pin and has a DC voltage present. An external DC block is required.
3	VPC	Power up/down control pin. The voltage on this pin should never exceed the voltage on pin 1 by more than 0.5V unless the supply current from pin 3 is limited < 10mA.
4	VDET	This is the output port for the power detector. It samples the power at the input of the amplifier.
5	RF OUT/VCC	This is the RF output pin and DC connection to the collector.
6	NC	This pin is not connected internal to the package. Buss it to pin 5 as shown on the app circuit to achieve the specified performance.
GND	GND	These pins are DC connected to the backside paddle. They provide good thermal connection to the backside paddle for hand soldering and rework. Many thermal and electrical GND vias are recommended as shown in the landing pattern.

Suggested Pad Layout

Dimensions in millimeters (inches)

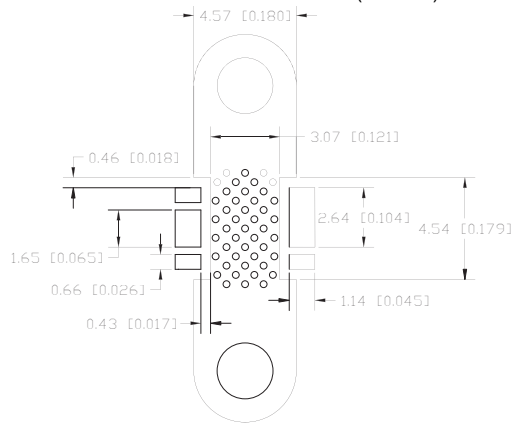

Package Drawing

Dimensions in millimeters (inches)

Refer to drawing posted at www.rfmd.com for tolerances.

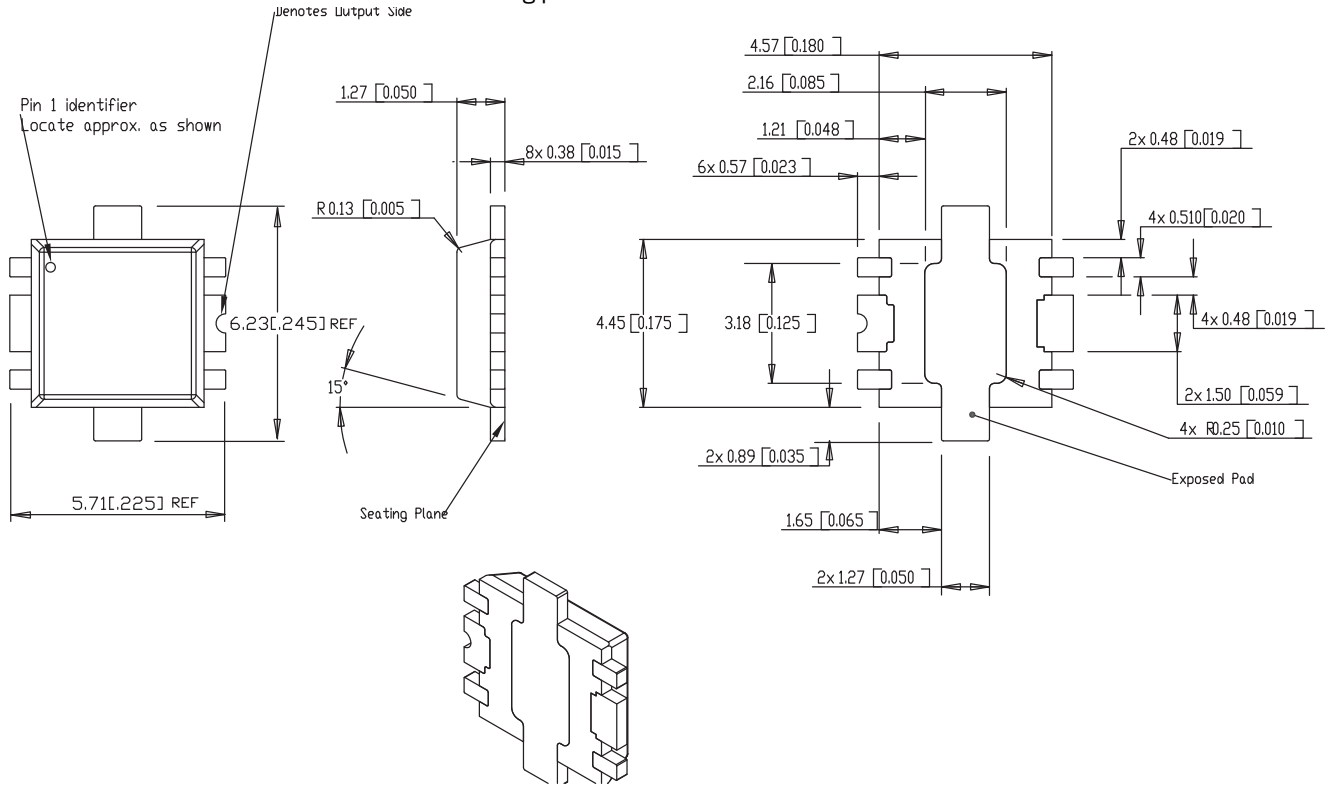

Recommended Soldermask Pattern

Dimensions in millimeters (inches)

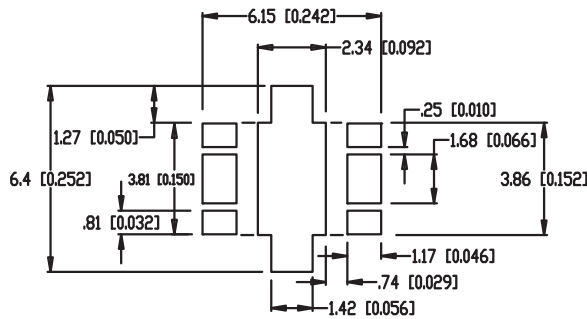

Ordering Information

Ordering Code	Description
SZP5026ZSQ	Standard 25 piece bag
SZP5026ZSR	Standard 100 piece reel
SZP5026Z	Standard 1000 piece reel
SZP5026Z-EVB1	Evaluation Board 5.15GHz to 5.35GHz Tune
SZP5026Z-EVB2	Evaluation Board 5.75GHz to 5.9GHz Tune
SZP5026HWDPC-410	Evaluation Board for a Balanced design and a driver for 4.9GHz to 5.9GHz