

64Mb H-die SDRAM Specification
54 TSOP-II with Pb-Free
(RoHS compliant)

Revision 1.3

August 2004

* Samsung Electronics reserves the right to change products or specification without notice.

SDRAM 64Mb H-die (x4, x8, x16)

CMOS SDRAM

Revision History

Revision 1.0 (September, 2003)

- Finalized

Revision 1.1 (October, 2003)

Deleted speed -7C and AC parameter notes 5.

Revision 1.2 (May, 2004)

- Added Note 5. sentence of tRDL parameter

Revision 1.3 (August, 2004)

- Corrected typo.

SDRAM 64Mb H-die (x4, x8, x16)

CMOS SDRAM

4M x 4Bit x 4 / 2M x 8Bit x 4 / 1M x 16Bit x 4 Banks Synchronous DRAM

FEATURES

- JEDEC standard 3.3V power supply
- LVTTTL compatible with multiplexed address
- Four banks operation
- MRS cycle with address key programs
 - . CAS latency (2 & 3)
 - . Burst length (1, 2, 4, 8 & Full page)
 - . Burst type (Sequential & Interleave)
- All inputs are sampled at the positive going edge of the system clock
- Burst read single-bit write operation
- DQM (x4,x8) & L(U)DQM (x16) for masking
- Auto & self refresh
- 64ms refresh period (4K cycle)
- **Pb-free Package**
- **RoHS compliant**

GENERAL DESCRIPTION

The K4S640432H / K4S640832H / K4S641632H is 67,108,864 bits synchronous high data rate Dynamic RAM organized as 4 x 4,194,304 words by 4 bits, / 4 x 2,097,152 words by 8 bits, / 4 x 1,048,576 words by 16 bits, fabricated with SAMSUNG's high performance CMOS technology. Synchronous design allows precise cycle control with the use of system clock I/O transactions are possible on every clock cycle. Range of operating frequencies, programmable burst length and programmable latencies allow the same device to be useful for a variety of high bandwidth, high performance memory system applications.

Ordering Information

Part No.	Organization	Max Freq.	Interface	Package
K4S640432H-UC(L)75	16Mb x 4	133MHz(CL=3)	LVTTTL	54pin TSOP(II)
K4S640832H-UC(L)75	8Mb x 8	133MHz(CL=3)		
K4S641632H-UC(L)60	4Mb x 16	166MHz(CL=3)		
K4S641632H-UC(L)70		143MHz(CL=3)		
K4S641632H-UC(L)75		133MHz(CL=3)		

Organization	Row Address	Column Address
16Mx4	A0~A11	A0-A9
8Mx8	A0~A11	A0-A8
4Mx16	A0~A11	A0-A7

Row & Column address configuration

SDRAM 64Mb H-die (x4, x8, x16)

CMOS SDRAM

Package Physical Dimension

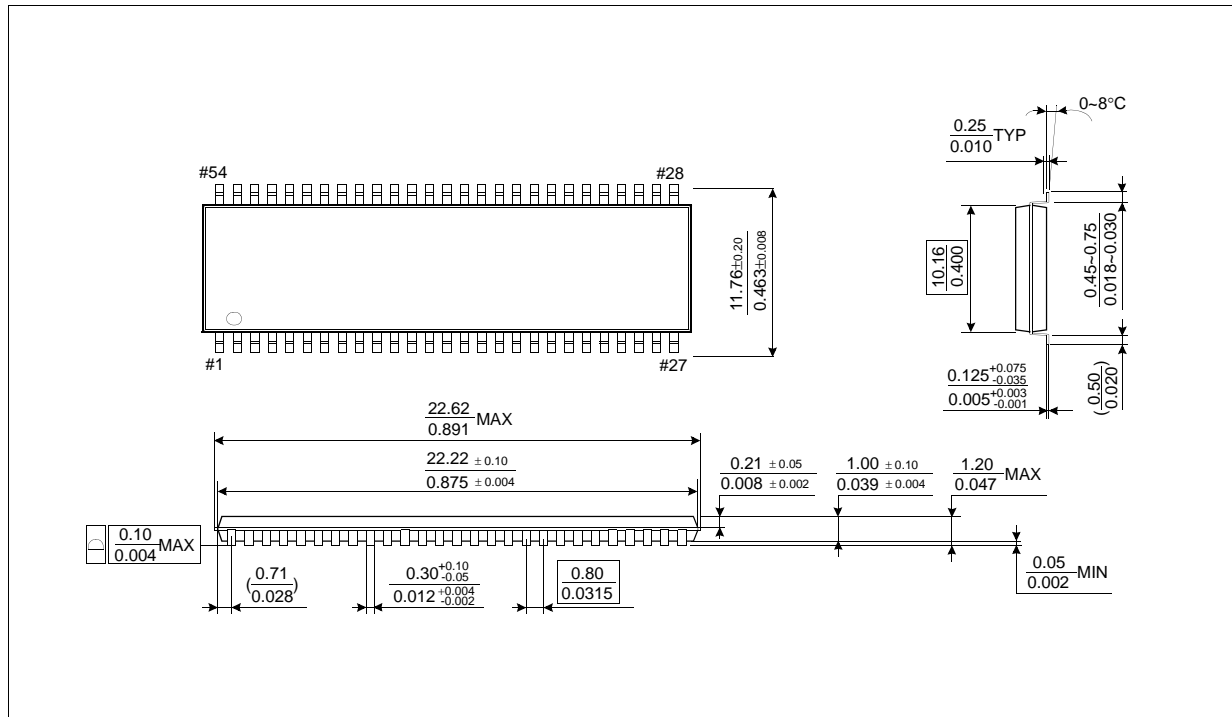

54Pin TSOP(II) Package Dimension

SDRAM 64Mb H-die (x4, x8, x16)

CMOS SDRAM

FUNCTIONAL BLOCK DIAGRAM

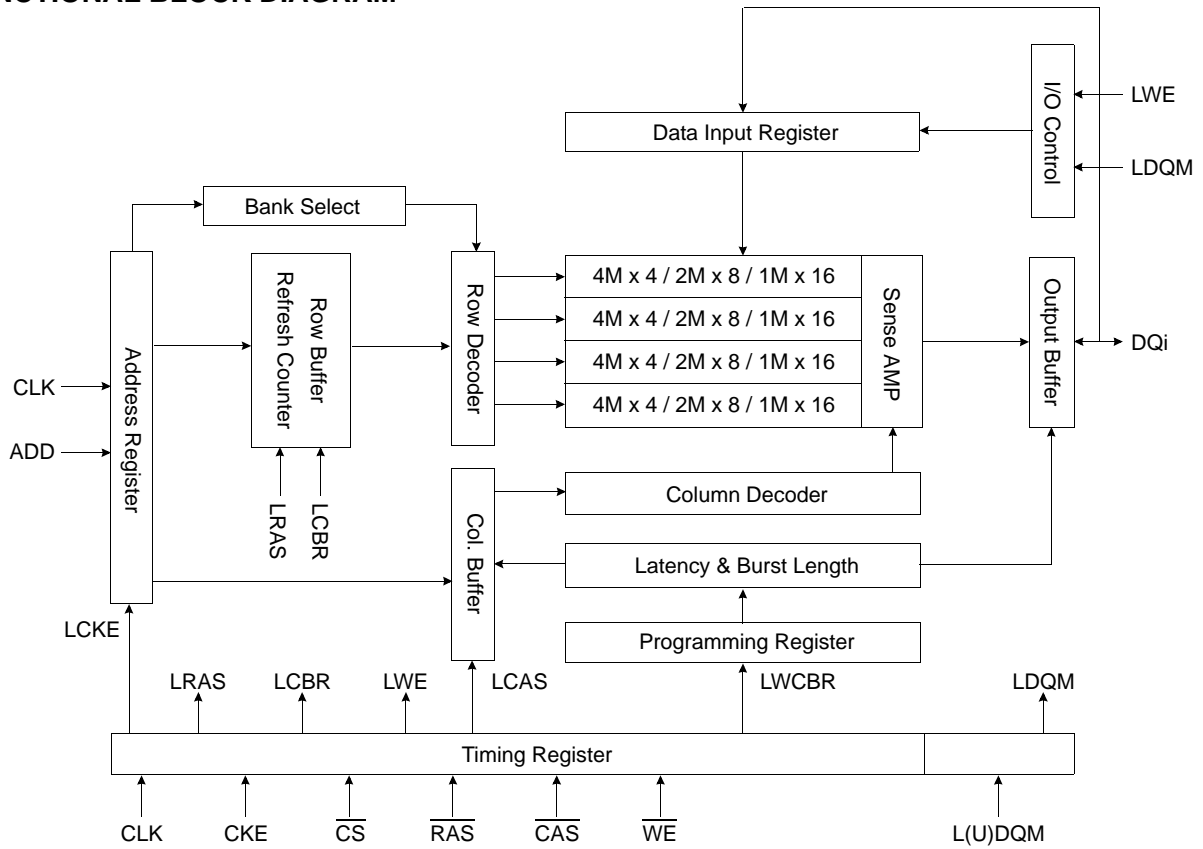

* Samsung Electronics reserves the right to change products or specification without notice.

SDRAM 64Mb H-die (x4, x8, x16)

CMOS SDRAM

PIN CONFIGURATION (Top view)

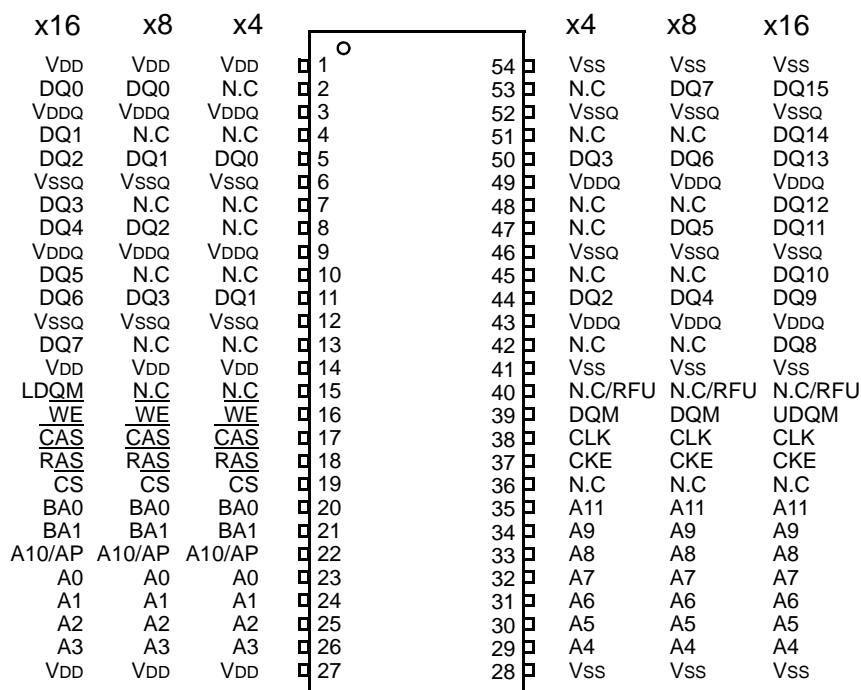

54Pin TSOP (II)
(400mil x 875mil)
(0.8 mm Pin pitch)

PIN FUNCTION DESCRIPTION

Pin	Name	Input Function
CLK	System clock	Active on the positive going edge to sample all inputs.
\overline{CS}	Chip select	Disables or enables device operation by masking or enabling all inputs except CLK, CKE and DQM
CKE	Clock enable	Masks system clock to freeze operation from the next clock cycle. CKE should be enabled at least one cycle prior to new command. Disable input buffers for power down in standby.
A0 ~ A11	Address	Row/column addresses are multiplexed on the same pins. Row address : RA0 ~ RA11, Column address : (x4 : CA0 ~ CA9, x8 : CA0 ~ CA8 , x16 : CA0 ~ CA7)
BA0 ~ BA1	Bank select address	Selects bank to be activated during row address latch time. Selects bank for read/write during column address latch time.
\overline{RAS}	Row address strobe	Latches row addresses on the positive going edge of the CLK with \overline{RAS} low. Enables row access & precharge.
\overline{CAS}	Column address strobe	Latches column addresses on the positive going edge of the CLK with \overline{CAS} low. Enables column access.
\overline{WE}	Write enable	Enables write operation and row precharge. Latches data in starting from \overline{CAS} , \overline{WE} active.
DQM	Data input/output mask	Makes data output Hi-Z, tSHZ after the clock and masks the output. Blocks data input when DQM active.
DQ0 ~ x15	Data input/output	Data inputs/outputs are multiplexed on the same pins.
VDD/VSS	Power supply/ground	Power and ground for the input buffers and the core logic.
VDDQ/VSSQ	Data output power/ground	Isolated power supply and ground for the output buffers to provide improved noise immunity.
N.C/RFU	No connection /reserved for future use	This pin is recommended to be left No Connection on the device.

SDRAM 64Mb H-die (x4, x8, x16)

CMOS SDRAM

ABSOLUTE MAXIMUM RATINGS

Parameter	Symbol	Value	Unit
Voltage on any pin relative to Vss	V _{IN} , V _{OUT}	-1.0 ~ 4.6	V
Voltage on VDD supply relative to Vss	VDD, VDDQ	-1.0 ~ 4.6	V
Storage temperature	T _{STG}	-55 ~ +150	°C
Power dissipation	P _D	1	W
Short circuit current	I _{OS}	50	mA

Note : Permanent device damage may occur if "ASOLUTE MAXIMUM RATINGS" are exceeded.
Functional operation should be restricted to recommended operating condition.
Exposure to higher than recommended voltage for extended periods of time could affect device reliability.

DC OPERATING CONDITIONS

Recommended operating conditions (Voltage referenced to Vss = 0V, T_A = 0 to 70°C)

Parameter	Symbol	Min	Typ	Max	Unit	Note
Supply voltage	VDD, VDDQ	3.0	3.3	3.6	V	
Input logic high voltage	V _{IH}	2.0	3.0	VDD+0.3	V	1
Input logic low voltage	V _{IL}	-0.3	0	0.8	V	2
Output logic high voltage	V _{OH}	2.4	-	-	V	I _{OH} = -2mA
Output logic low voltage	V _{OL}	-	-	0.4	V	I _{OL} = 2mA
Input leakage current	I _{LI}	-10	-	10	uA	3

Notes : 1. V_{IH} (max) = 5.6V AC. The overshoot voltage duration is ≤ 3ns.
2. V_{IL} (min) = -2.0V AC. The undershoot voltage duration is ≤ 3ns.
3. Any input 0V ≤ V_{IN} ≤ VDDQ.
Input leakage currents include Hi-Z output leakage for all bi-directional buffers with Tri-State outputs.

CAPACITANCE (VDD = 3.3V, T_A = 23°C, f = 1MHz, VREF = 1.4V ± 200 mV)

Pin	Symbol	Min	Max	Unit	Note
Clock	CCLK	2.5	4.0	pF	1
RAS, CAS, WE, CS, CKE, DQM	CIN	2.5	5.0	pF	2
Address	CADD	2.5	5.0	pF	2
DQ ₀ ~ DQ ₃	CO _{UT}	4.0	6.5	pF	3

Notes : 1. -75 only specify a maximum value of 3.5pF
2. -75 only specify a maximum value of 3.8pF
3. -75 only specify a maximum value of 6.0pF

SDRAM 64Mb H-die (x4, x8, x16)

CMOS SDRAM

DC CHARACTERISTICS

(Recommended operating condition unless otherwise noted, TA = 0 to 70°C for x4, x8)

Parameter	Symbol	Test Condition	Version	Unit	Note	
			75			
Operating current (One bank active)	I _{CC1}	Burst length = 1 trc ≥ trc(min) I _o = 0 mA	75	mA	1	
Precharge standby current in power-down mode	I _{CC2P}	CKE ≤ V _{IL} (max), t _{CC} = 10ns	1	mA		
	I _{CC2PS}	CKE & CLK ≤ V _{IL} (max), t _{CC} = ∞	1			
Precharge standby current in non power-down mode	I _{CC2N}	CKE ≥ V _{IH} (min), CS ≥ V _{IH} (min), t _{CC} = 10ns Input signals are changed one time during 20ns	15	mA		
	I _{CC2NS}	CKE ≥ V _{IH} (min), CLK ≤ V _{IL} (max), t _{CC} = ∞ Input signals are stable	6			
Active standby current in power-down mode	I _{CC3P}	CKE ≤ V _{IL} (max), t _{CC} = 10ns	3	mA		
	I _{CC3PS}	CKE & CLK ≤ V _{IL} (max), t _{CC} = ∞	3			
Active standby current in non power-down mode (One bank active)	I _{CC3N}	CKE ≥ V _{IH} (min), CS ≥ V _{IH} (min), t _{CC} = 10ns Input signals are changed one time during 20ns	30	mA		
	I _{CC3NS}	CKE ≥ V _{IH} (min), CLK ≤ V _{IL} (max), t _{CC} = ∞ Input signals are stable	25			
Operating current (Burst mode)	I _{CC4}	I _o = 0 mA Page burst 4Banks Activated t _{CCD} = 2CLKs	115	mA	1	
Refresh current	I _{CC5}	trc ≥ trc(min)	135	mA	2	
Self refresh current	I _{CC6}	CKE ≤ 0.2V	C	1	mA	3
			L	400	uA	4

Notes : 1. Measured with outputs open.

2. Refresh period is 64ms.

3. K4S6404(08)32H-TC**

4. K4S6404(08)32H-TL**

5. Unless otherwise noted, input swing level is CMOS(V_{IH}/V_{IL}=V_{DDQ}/V_{SSQ})

SDRAM 64Mb H-die (x4, x8, x16)

CMOS SDRAM

DC CHARACTERISTICS

(Recommended operating condition unless otherwise noted, TA = 0 to 70°C for x16 only)

Parameter	Symbol	Test Condition	Version			Unit	Note
			60	70	75		
Operating current (One bank active)	I _{CC1}	Burst length = 1 t _{RC} ≥ t _{RC} (min) I _O = 0 mA	140	115	110	mA	1
Precharge standby current in power-down mode	I _{CC2P}	CKE ≤ V _{IL} (max), t _{CC} = 10ns	1			mA	
	I _{CC2PS}	CKE & CLK ≤ V _{IL} (max), t _{CC} = ∞	1				
Precharge standby current in non power-down mode	I _{CC2N}	CKE ≥ V _{IH} (min), \overline{CS} ≥ V _{IH} (min), t _{CC} = 10ns Input signals are changed one time during 20ns	15			mA	
	I _{CC2NS}	CKE ≥ V _{IH} (min), CLK ≤ V _{IL} (max), t _{CC} = ∞ Input signals are stable	6				
Active standby current in power-down mode	I _{CC3P}	CKE ≤ V _{IL} (max), t _{CC} = 10ns	3			mA	
	I _{CC3PS}	CKE & CLK ≤ V _{IL} (max), t _{CC} = ∞	3				
Active standby current in non power-down mode (One bank active)	I _{CC3N}	CKE ≥ V _{IH} (min), \overline{CS} ≥ V _{IH} (min), t _{CC} = 10ns Input signals are changed one time during 20ns	30			mA	
	I _{CC3NS}	CKE ≥ V _{IH} (min), CLK ≤ V _{IL} (max), t _{CC} = ∞ Input signals are stable	25				
Operating current (Burst mode)	I _{CC4}	I _O = 0 mA Page burst 4Banks Activated t _{CCD} = 2CLKs	160	140	135	mA	1
Refresh current	I _{CC5}	t _{RC} ≥ t _{RC} (min)	160	140	135	mA	2
Self refresh current	I _{CC6}	CKE ≤ 0.2V	C	1		mA	3
			L	400		uA	4

Notes : 1. Measured with outputs open.

2. Refresh period is 64ms.

3. K4S641632H-TC**

4. K4S641632H-TL**

5. Unless otherwise noted, input swing level is CMOS(V_{IH} / V_{IL} = V_{DDQ} / V_{SSQ})

SDRAM 64Mb H-die (x4, x8, x16)

CMOS SDRAM

AC OPERATING TEST CONDITIONS ($V_{DD} = 3.3V \pm 0.3V$, $T_A = 0$ to $70^\circ C$)

Parameter	Value	Unit
AC input levels (V_{ih}/V_{il})	2.4/0.4	V
Input timing measurement reference level	1.4	V
Input rise and fall time	$tr/tf = 1/1$	ns
Output timing measurement reference level	1.4	V
Output load condition	See Fig. 2	

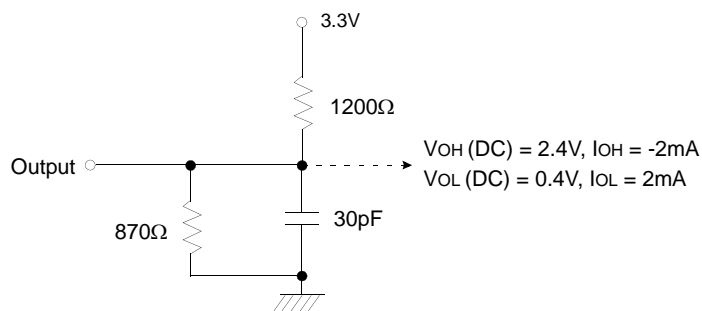

(Fig. 1) DC output load circuit

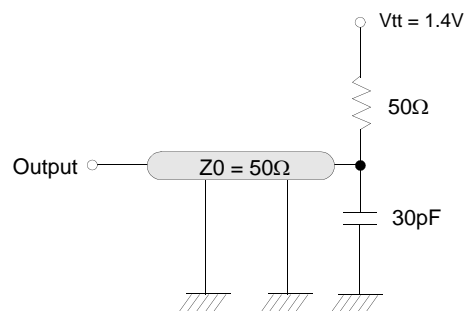

(Fig. 2) AC output load circuit

OPERATING AC PARAMETER

(AC operating conditions unless otherwise noted)

Parameter	Symbol	Version			Unit	Note
		60	70	75		
Row active to row active delay	$t_{RRD}(\min)$	12	14	15	ns	1
RAS to CAS delay	$t_{RCD}(\min)$	18	20	20	ns	1
Row precharge time	$t_{RP}(\min)$	18	20	20	ns	1
Row active time	$t_{RAS}(\min)$	42	49	45	ns	1
	$t_{RAS}(\max)$	100			us	
Row cycle time	$t_{RC}(\min)$	60	68	65	ns	1
Last data in to row precharge	$t_{RDL}(\min)$	2			CLK	2,5
Last data in to Active delay	$t_{DAL}(\min)$	2 CLK + t_{RP}			-	5
Last data in to new col. address delay	$t_{CDL}(\min)$	1			CLK	2
Last data in to burst stop	$t_{BDL}(\min)$	1			CLK	2
Col. address to col. address delay	$t_{CCD}(\min)$	1			CLK	3
Number of valid output data	CAS latency = 3	2			ea	4
	CAS latency = 2	1				

- Notes :**
1. The minimum number of clock cycles is determined by dividing the minimum time required with clock cycle time and then rounding off to the next higher integer.
 2. Minimum delay is required to complete write.
 3. All parts allow every cycle column address change.
 4. In case of row precharge interrupt, auto precharge and read burst stop.
 5. In 100MHz and below 100MHz operating conditions, $t_{RDL}=1CLK$ and $t_{DAL}=1CLK + 20ns$ is also supported. SAMSUNG recommends $t_{RDL}=2CLK$ and $t_{DAL}=2CLK + t_{RP}$.

SDRAM 64Mb H-die (x4, x8, x16)

CMOS SDRAM

AC CHARACTERISTICS (AC operating conditions unless otherwise noted)

Parameter		Symbol	60		70		75		Unit	Note
			Min	Max	Min	Max	Min	Max		
CLK cycle time	CAS latency=3	tcc	6	1000	7	1000	7.5	1000	ns	1
	CAS latency=2		-		-		10			
CLK to valid output delay	CAS latency=3	tsac		5		6		5.4	ns	1,2
	CAS latency=2			-		-		6		
Output data hold time	CAS latency=3	toH	2.5		3		3		ns	2
	CAS latency=2		-		-		3			
CLK high pulse width		tch	2.5		3		2.5		ns	3
CLK low pulse width		tcl	2.5		3		2.5		ns	3
Input setup time		tss	1.5		2		1.5		ns	3
Input hold time		tsh	1		1		0.8		ns	3
CLK to output in Low-Z		tslz	1		1		1		ns	2
CLK to output in Hi-Z	CAS latency=3	tshz		5		6		5.4	ns	
	CAS latency=2			-		-		6		

Notes : 1. Parameters depend on programmed CAS latency.

2. If clock rising time is longer than 1ns, $(tr/2-0.5)ns$ should be added to the parameter.

3. Assumed input rise and fall time (tr & tf) = 1ns.

If tr & tf is longer than 1ns, transient time compensation should be considered, i.e., $[(tr + tf)/2-1]ns$ should be added to the parameter.

DQ BUFFER OUTPUT DRIVE CHARACTERISTICS

Parameter	Symbol	Condition	Min	Typ	Max	Unit	Notes
Output rise time	trh	Measure in linear region : 1.2V ~ 1.8V	1.37		4.37	Volts/ns	3
Output fall time	tfh	Measure in linear region : 1.2V ~ 1.8V	1.30		3.8	Volts/ns	3
Output rise time	trh	Measure in linear region : 1.2V ~ 1.8V	2.8	3.9	5.6	Volts/ns	1,2
Output fall time	tfh	Measure in linear region : 1.2V ~ 1.8V	2.0	2.9	5.0	Volts/ns	1,2

Notes : 1. Rise time specification based on 0pF + 50 Ω to Vss, use these values to design to.

2. Fall time specification based on 0pF + 50 Ω to VDD, use these values to design to.

3. Measured into 50pF only, use these values to characterize to.

4. All measurements done with respect to Vss.

SDRAM 64Mb H-die (x4, x8, x16)

CMOS SDRAM

IBIS SPECIFICATION

I_{OH} Characteristics (Pull-up)

Voltage	133MHz Min	133MHz Max
(V)	I (mA)	I (mA)
3.45	-	-1.68
3.30	-	-19.11
3.00	-0.35	-51.87
2.70	-3.75	-90.44
2.50	-6.65	-107.31
1.95	-13.75	-137.9
1.80	-17.75	-158.34
1.65	-20.55	-173.6
1.50	-23.55	-188.79
1.40	-26.2	-199.01
1.00	-36.25	-241.15
0.20	-46.5	-351.68

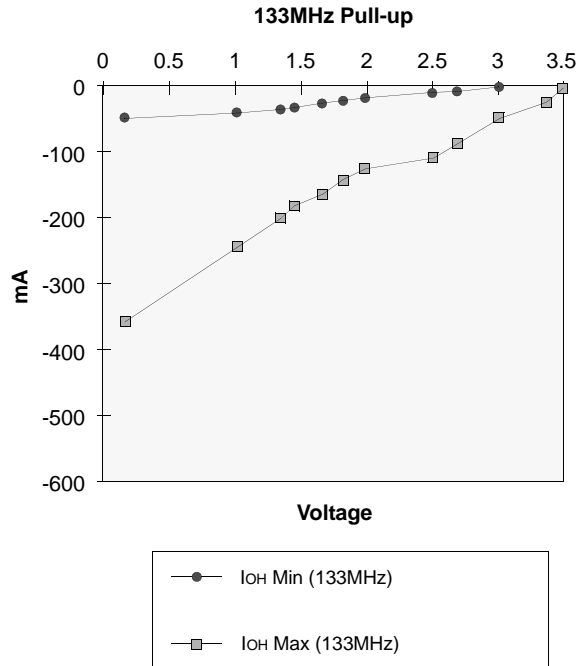

I_{OL} Characteristics (Pull-down)

Voltage	133MHz Min	133MHz Max
(V)	I (mA)	I (mA)
3.45	43.92	155.82
3.30	-	-
3.00	43.36	153.72
1.95	41.20	148.40
1.80	40.56	146.02
1.65	39.60	141.75
1.50	38.40	136.08
1.40	37.28	131.39
1.00	30.08	105.84
0.85	26.64	93.66
0.65	21.52	75.25
0.40	14.16	49.14

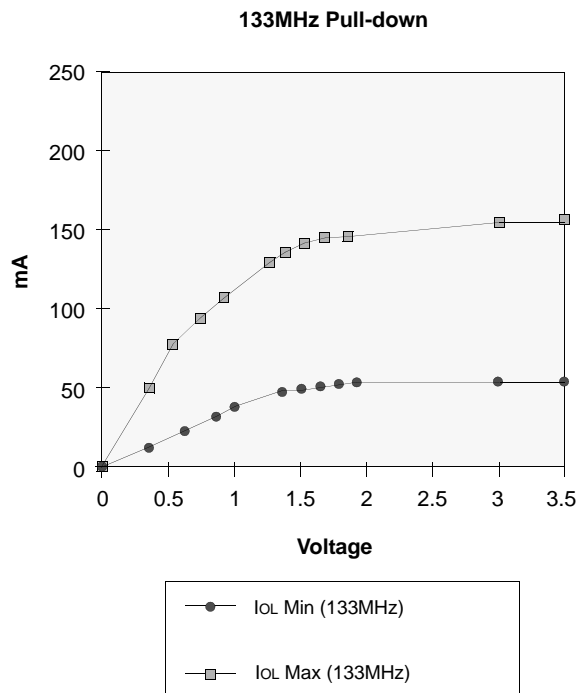

SDRAM 64Mb H-die (x4, x8, x16)

CMOS SDRAM

V_{DD} Clamp @ CLK, CKE, $\overline{\text{CS}}$, DQM & DQ

V _{DD} (V)	I (mA)
0.0	0.0
0.2	0.0
0.4	0.0
0.6	0.0
0.7	0.0
0.8	0.0
0.9	0.0
1.0	0.23
1.2	1.34
1.4	3.02
1.6	5.06
1.8	7.35
2.0	9.83
2.2	12.48
2.4	15.30
2.6	18.31

**Minimum V_{DD} clamp current
(Referenced to V_{DD})**

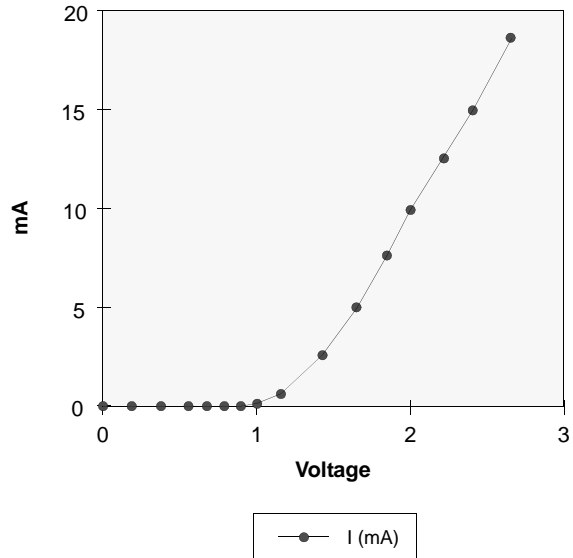

V_{SS} Clamp @ CLK, CKE, $\overline{\text{CS}}$, DQM & DQ

V _{SS} (V)	I (mA)
-2.6	-57.23
-2.4	-45.77
-2.2	-38.26
-2.0	-31.22
-1.8	-24.58
-1.6	-18.37
-1.4	-12.56
-1.2	-7.57
-1.0	-3.37
-0.9	-1.75
-0.8	-0.58
-0.7	-0.05
-0.6	0.0
-0.4	0.0
-0.2	0.0
0.0	0.0

Minimum V_{SS} clamp current

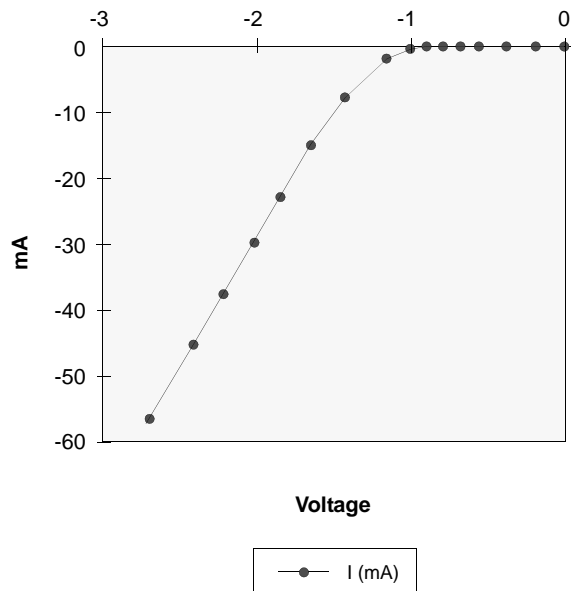

SDRAM 64Mb H-die (x4, x8, x16)

CMOS SDRAM

SIMPLIFIED TRUTH TABLE

(V=Valid, X=Don't care, H=Logic high, L=Logic low)

Command		CKEn-1	CKEn	\overline{CS}	\overline{RAS}	\overline{CAS}	\overline{WE}	DQM	BA _{0,1}	A _{10/AP}	A ₁₁ , A _{9 ~ A₀}	Note
Register	Mode register set	H	X	L	L	L	L	X	OP code			1,2
Refresh	Auto refresh	H	H	L	L	L	H	X	X			3
	Self refresh		Entry								L	
		Exit	L	H	L	H	H	H	X	X		3
					H	X	X	X				
Bank active & row addr.		H	X	L	L	H	H	X	V	Row address		
Read & column address	Auto precharge disable	H	X	L	H	L	H	X	V	L	Column address	4
	Auto precharge enable									H		4,5
Write & column address	Auto precharge disable	H	X	L	H	L	L	X	V	L	Column address	4
	Auto precharge enable									H		4,5
Burst stop		H	X	L	H	H	L	X	X			6
Precharge	Bank selection	H	X	L	L	H	L	X	V	L	X	
	All banks								X	H		
Clock suspend or active power down	Entry	H	L	H	X	X	X	X	X			
	Exit			L	H	X	X				X	X
Precharge power down mode	Entry	H	L	H	X	X	X	X	X			
				L	H	H	H					
	Exit	L	H	H	X	X	X	X	X			
				L	V	V	V					
DQM		H			X				V	X		7
No operation command		H	X	H	X	X	X	X	X			
				L	H	H	H					

Notes : 1. OP Code : Operand code

A_{0 ~ A₁₁} & BA_{0 ~ BA₁} : Program keys. (@ MRS)

2. MRS can be issued only at all banks precharge state.

A new command can be issued after 2 CLK cycles of MRS.

3. Auto refresh functions are as same as CBR refresh of DRAM.

The automatical precharge without row precharge command is meant by "Auto".

Auto/self refresh can be issued only at all banks precharge state.

4. BA_{0 ~ BA₁} : Bank select addresses.

If both BA₀ and BA₁ are "Low" at read, write, row active and precharge, bank A is selected.

If both BA₀ is "Low" and BA₁ is "High" at read, write, row active and precharge, bank B is selected.

If both BA₀ is "High" and BA₁ is "Low" at read, write, row active and precharge, bank C is selected.

If both BA₀ and BA₁ are "High" at read, write, row active and precharge, bank D is selected.

If A_{10/AP} is "High" at row precharge, BA₀ and BA₁ is ignored and all banks are selected.

5. During burst read or write with auto precharge, new read/write command can not be issued.

Another bank read/write command can be issued after the end of burst.

New row active of the associated bank can be issued at t_{RP} after the end of burst.

6. Burst stop command is valid at every burst length.

7. DQM sampled at positive going edge of a CLK and masks the data-in at the very CLK (Write DQM latency is 0),

but makes Hi-Z state the data-out of 2 CLK cycles after. (Read DQM latency is 2)