

# DDR2 Unbuffered SDRAM MODULE

**240pin Unbuffered Module based on 256Mb F-die**

**64/72-bit Non-ECC/ECC**

**INFORMATION IN THIS DOCUMENT IS PROVIDED IN RELATION TO SAMSUNG PRODUCTS,  
AND IS SUBJECT TO CHANGE WITHOUT NOTICE.**

**NOTHING IN THIS DOCUMENT SHALL BE CONSTRUED AS GRANTING ANY LICENSE,  
EXPRESS OR IMPLIED, BY ESTOPPEL OR OTHERWISE,**

**TO ANY INTELLECTUAL PROPERTY RIGHTS IN SAMSUNG PRODUCTS OR TECHNOLOGY. ALL  
INFORMATION IN THIS DOCUMENT IS PROVIDED**

**ON AS "AS IS" BASIS WITHOUT GUARANTEE OR WARRANTY OF ANY KIND.**

1. For updates or additional information about Samsung products, contact your nearest Samsung office.
2. Samsung products are not intended for use in life support, critical care, medical, safety equipment, or similar applications where Product failure could result in loss of life or personal or physical harm, or any military or defense application, or any governmental procurement to which special terms or provisions may apply.

\* Samsung Electronics reserves the right to change products or specification without notice.

## 256MB, 512MB Unbuffered DIMMs

## DDR2 SDRAM

### DDR2 Unbuffered DIMM Ordering Information

Part Number	Density	Organization	Component Composition	Number of Rank	Height
<b>x64 Non ECC</b>					
M378T3253FG(Z)3-CE6/D5/CC	256MB	32Mx64	32Mx8(K4T56083QF)*8	1	30mm
M378T3253FG(Z)0-CE6/D5/CC	256MB	32Mx64	32Mx8(K4T56083QF)*8	1	30mm
M378T6453FG(Z)3-CE6/D5/CC	512MB	64Mx64	32Mx8(K4T56083QF)*16	2	30mm
M378T6453FG(Z)0-CE6/D5/CC	512MB	64Mx64	32Mx8(K4T56083QF)*16	2	30mm
<b>x72 ECC</b>					
M391T3253FG(Z)3-CE6/D5/CC	256MB	32Mx72	32Mx8(K4T56083QF)*9	1	30mm
M391T3253FG(Z)0-CE6/D5/CC	256MB	32Mx72	32Mx8(K4T56083QF)*9	1	30mm
M391T6453FG(Z)3-CE6/D5/CC	512MB	64Mx72	32Mx8(K4T56083QF)*18	2	30mm
M391T6453FG(Z)0-CE6/D5/CC	512MB	64Mx72	32Mx8(K4T56083QF)*18	2	30mm

Note: "Z" of Part number(11th digit) stand for Lead-free products.

Note: "3" of Part number(12th digit) stand for Dummy Pad PCB products.

### Features

- Performance range

	E6(DDR2-667)	D5(DDR2-533)	CC(DDR2-400)	Unit
Speed@CL3	400	400	400	Mbps
Speed@CL4	533	533	400	Mbps
Speed@CL5	667	-	-	Mbps
CL-tRCD-tRP	5-5-5	4-4-4	3-3-3	CK

- JEDEC standard 1.8V ± 0.1V Power Supply
- $V_{DDQ} = 1.8V \pm 0.1V$
- 200 MHz  $f_{CK}$  for 400Mb/sec/pin, 267MHz  $f_{CK}$  for 533Mb/sec/pin, 333MHz  $f_{CK}$  for 667Mb/sec/pin
- 4 Banks
- Posted  $\overline{CAS}$
- Programmable  $\overline{CAS}$  Latency: 3, 4, 5
- Programmable Additive Latency: 0, 1, 2, 3 and 4
- Write Latency(WL) = Read Latency(RL) - 1
- Burst Length: 4, 8(Interleave/nibble sequential)
- Programmable Sequential / Interleave Burst Mode
- Bi-directional Differential Data-Strobe (Single-ended data-strobe is an optional feature)
- Off-Chip Driver(OCD) Impedance Adjustment
- On Die Termination
- Average Refresh Period 7.8us at lower than a  $T_{CASE} 85^{\circ}C$ , 3.9us at  $85^{\circ}C < T_{CASE} \leq 95^{\circ}C$   
- support High Temperature Self-Refresh rate enable feature
- Package: 60ball FBGA - 32Mx8
- All of Lead-free products are compliant for RoHS

Note: For detailed DDR2 SDRAM operation, please refer to Samsung's Device operation & Timing diagram.

### Address Configuration

Organization	Row Address	Column Address	Bank Address	Auto Precharge
32Mx8(256Mb) based Module	A0-A12	A0-A9	BA0-BA1	A10

256MB, 512MB Unbuffered DIMMs

DDR2 SDRAM

x64 DIMM Pin Configurations (Front side/Back side)

Pin	Front	Pin	Back	Pin	Front	Pin	Back	Pin	Front	Pin	Back	Pin	Front	Pin	Back
1	V <sub>REF</sub>	121	V <sub>SS</sub>	31	DQ19	151	V <sub>SS</sub>	61	A4	181	V <sub>DDQ</sub>	91	V <sub>SS</sub>	211	DM5
2	V <sub>SS</sub>	122	DQ4	32	V <sub>SS</sub>	152	DQ28	62	V <sub>DDQ</sub>	182	A3	92	$\overline{\text{DQS}}5$	212	NC
3	DQ0	123	DQ5	33	DQ24	153	DQ29	63	A2	183	A1	93	DQS5	213	V <sub>SS</sub>
4	DQ1	124	V <sub>SS</sub>	34	DQ25	154	V <sub>SS</sub>	64	V <sub>DD</sub>	184	V <sub>DD</sub>	94	V <sub>SS</sub>	214	DQ46
5	V <sub>SS</sub>	125	DM0	35	V <sub>SS</sub>	155	DM3	KEY				95	DQ42	215	DQ47
6	$\overline{\text{DQS}}0$	126	NC	36	$\overline{\text{DQS}}3$	156	NC	65	V <sub>SS</sub>	185	CK0	96	DQ43	216	V <sub>SS</sub>
7	DQS0	127	V <sub>SS</sub>	37	DQS3	157	V <sub>SS</sub>	66	V <sub>SS</sub>	186	$\overline{\text{CK}}0$	97	V <sub>SS</sub>	217	DQ52
8	V <sub>SS</sub>	128	DQ6	38	V <sub>SS</sub>	158	DQ30	67	V <sub>DD</sub>	187	V <sub>DD</sub>	98	DQ48	218	DQ53
9	DQ2	129	DQ7	39	DQ26	159	DQ31	68	NC	188	A0	99	DQ49	219	V <sub>SS</sub>
10	DQ3	130	V <sub>SS</sub>	40	DQ27	160	V <sub>SS</sub>	69	V <sub>DD</sub>	189	V <sub>DD</sub>	100	V <sub>SS</sub>	220	CK2
11	V <sub>SS</sub>	131	DQ12	41	V <sub>SS</sub>	161	NC	70	A10/AP	190	BA1	101	SA2	221	$\overline{\text{CK}}2$
12	DQ8	132	DQ13	42	NC	162	NC	71	BA0	191	V <sub>DDQ</sub>	102	NC, TEST <sup>2</sup>	222	V <sub>SS</sub>
13	DQ9	133	V <sub>SS</sub>	43	NC	163	V <sub>SS</sub>	72	V <sub>DDQ</sub>	192	$\overline{\text{RAS}}$	103	V <sub>SS</sub>	223	DM6
14	V <sub>SS</sub>	134	DM1	44	V <sub>SS</sub>	164	NC	73	$\overline{\text{WE}}$	193	$\overline{\text{S}}0$	104	$\overline{\text{DQS}}6$	224	NC
15	$\overline{\text{DQS}}1$	135	NC	45	NC	165	NC	74	$\overline{\text{CAS}}$	194	V <sub>DDQ</sub>	105	DQS6	225	V <sub>SS</sub>
16	DQS1	136	V <sub>SS</sub>	46	NC	166	V <sub>SS</sub>	75	V <sub>DDQ</sub>	195	ODT0	106	V <sub>SS</sub>	226	DQ54
17	V <sub>SS</sub>	137	CK1	47	V <sub>SS</sub>	167	NC	76	$\overline{\text{S}}1$	196	NC	107	DQ50	227	DQ55
18	NC	138	$\overline{\text{CK}}1$	48	NC	168	NC	77	ODT1	197	V <sub>DD</sub>	108	DQ51	228	V <sub>SS</sub>
19	NC	139	V <sub>SS</sub>	49	NC	169	V <sub>SS</sub>	78	V <sub>DDQ</sub>	198	V <sub>SS</sub>	109	V <sub>SS</sub>	229	DQ60
20	V <sub>SS</sub>	140	DQ14	50	V <sub>SS</sub>	170	V <sub>DDQ</sub>	79	V <sub>SS</sub>	199	DQ36	110	DQ56	230	DQ61
21	DQ10	141	DQ15	51	V <sub>DDQ</sub>	171	CKE1	80	DQ32	200	DQ37	111	DQ57	231	V <sub>SS</sub>
22	DQ11	142	V <sub>SS</sub>	52	CKE0	172	V <sub>DD</sub>	81	DQ33	201	V <sub>SS</sub>	112	V <sub>SS</sub>	232	DM7
23	V <sub>SS</sub>	143	DQ20	53	V <sub>DD</sub>	173	NC	82	V <sub>SS</sub>	202	DM4	113	$\overline{\text{DQS}}7$	233	NC
24	DQ16	144	DQ21	54	NC	174	NC	83	$\overline{\text{DQS}}4$	203	NC	114	DQS7	234	V <sub>SS</sub>
25	DQ17	145	V <sub>SS</sub>	55	NC	175	V <sub>DDQ</sub>	84	DQS4	204	V <sub>SS</sub>	115	V <sub>SS</sub>	235	DQ62
26	V <sub>SS</sub>	146	DM2	56	V <sub>DDQ</sub>	176	A12	85	V <sub>SS</sub>	205	DQ38	116	DQ58	236	DQ63
27	$\overline{\text{DQS}}2$	147	NC	57	A11	177	A9	86	DQ34	206	DQ39	117	DQ59	237	V <sub>SS</sub>
28	DQS2	148	V <sub>SS</sub>	58	A7	178	V <sub>DD</sub>	87	DQ35	207	V <sub>SS</sub>	118	V <sub>SS</sub>	238	VDDSPD
29	V <sub>SS</sub>	149	DQ22	59	V <sub>DD</sub>	179	A8	88	V <sub>SS</sub>	208	DQ44	119	SDA	239	SA0
30	DQ18	150	DQ23	60	A5	180	A6	89	DQ40	209	DQ45	120	SCL	240	SA1
								90	DQ41	210	V <sub>SS</sub>				

NC = No Connect, RFU = Reserved for Future Use

1. Pin173 Pin174 are reserved for 2Gb/4Gb comp. base Unbuffered DIMM.

2. The TEST pin is reserved for bus analysis tools and is not connected on standard memory module products (DIMMs.)

## 256MB, 512MB Unbuffered DIMMs

## DDR2 SDRAM

### x72 DIMM Pin Configurations (Front side/Back side)

Pin	Front	Pin	Back	Pin	Front	Pin	Back	Pin	Front	Pin	Back	Pin	Front	Pin	Back
1	V <sub>REF</sub>	121	V <sub>SS</sub>	31	DQ19	151	V <sub>SS</sub>	61	A4	181	V <sub>DDQ</sub>	91	V <sub>SS</sub>	211	DM5
2	V <sub>SS</sub>	122	DQ4	32	V <sub>SS</sub>	152	DQ28	62	V <sub>DDQ</sub>	182	A3	92	DQS5	212	NC
3	DQ0	123	DQ5	33	DQ24	153	DQ29	63	A2	183	A1	93	DQS5	213	V <sub>SS</sub>
4	DQ1	124	V <sub>SS</sub>	34	DQ25	154	V <sub>SS</sub>	64	V <sub>DD</sub>	184	V <sub>DD</sub>	94	V <sub>SS</sub>	214	DQ46
5	V <sub>SS</sub>	125	DM0	35	V <sub>SS</sub>	155	DM3	KEY				95	DQ42	215	DQ47
6	DQS0	126	NC	36	DQS3	156	NC	65	V <sub>SS</sub>	185	CK0	96	DQ43	216	V <sub>SS</sub>
7	DQS0	127	V <sub>SS</sub>	37	DQS3	157	V <sub>SS</sub>	66	V <sub>SS</sub>	186	CK0	97	V <sub>SS</sub>	217	DQ52
8	V <sub>SS</sub>	128	DQ6	38	V <sub>SS</sub>	158	DQ30	67	V <sub>DD</sub>	187	V <sub>DD</sub>	98	DQ48	218	DQ53
9	DQ2	129	DQ7	39	DQ26	159	DQ31	68	NC	188	A0	99	DQ49	219	V <sub>SS</sub>
10	DQ3	130	V <sub>SS</sub>	40	DQ27	160	V <sub>SS</sub>	69	V <sub>DD</sub>	189	V <sub>DD</sub>	100	V <sub>SS</sub>	220	CK2
11	V <sub>SS</sub>	131	DQ12	41	V <sub>SS</sub>	161	CB4	70	A10/AP	190	BA1	101	SA2	221	CK2
12	DQ8	132	DQ13	42	CB0	162	CB5	71	BA0	191	V <sub>DDQ</sub>	102	NC, TEST <sup>2</sup>	222	V <sub>SS</sub>
13	DQ9	133	V <sub>SS</sub>	43	CB1	163	V <sub>SS</sub>	72	V <sub>DDQ</sub>	192	RAS	103	V <sub>SS</sub>	223	DM6
14	V <sub>SS</sub>	134	DM1	44	V <sub>SS</sub>	164	DM8	73	WE	193	S0	104	DQS6	224	NC
15	DQS1	135	NC	45	DQS8	165	NC	74	CAS	194	V <sub>DDQ</sub>	105	DQS6	225	V <sub>SS</sub>
16	DQS1	136	V <sub>SS</sub>	46	DQS8	166	V <sub>SS</sub>	75	V <sub>DDQ</sub>	195	ODT0	106	V <sub>SS</sub>	226	DQ54
17	V <sub>SS</sub>	137	CK1	47	V <sub>SS</sub>	167	CB6	76	S1	196	NC	107	DQ50	227	DQ55
18	NC	138	CK1	48	CB2	168	CB7	77	ODT1	197	V <sub>DD</sub>	108	DQ51	228	V <sub>SS</sub>
19	NC	139	V <sub>SS</sub>	49	CB3	169	V <sub>SS</sub>	78	V <sub>DDQ</sub>	198	V <sub>SS</sub>	109	V <sub>SS</sub>	229	DQ60
20	V <sub>SS</sub>	140	DQ14	50	V <sub>SS</sub>	170	V <sub>DDQ</sub>	79	V <sub>SS</sub>	199	DQ36	110	DQ56	230	DQ61
21	DQ10	141	DQ15	51	V <sub>DDQ</sub>	171	CKE1	80	DQ32	200	DQ37	111	DQ57	231	V <sub>SS</sub>
22	DQ11	142	V <sub>SS</sub>	52	CKE0	172	V <sub>DD</sub>	81	DQ33	201	V <sub>SS</sub>	112	V <sub>SS</sub>	232	DM7
23	V <sub>SS</sub>	143	DQ20	53	V <sub>DD</sub>	173	NC	82	V <sub>SS</sub>	202	DM4	113	DQS7	233	NC
24	DQ16	144	DQ21	54	NC	174	NC	83	DQS4	203	NC	114	DQS7	234	V <sub>SS</sub>
25	DQ17	145	V <sub>SS</sub>	55	NC	175	V <sub>DDQ</sub>	84	DQS4	204	V <sub>SS</sub>	115	V <sub>SS</sub>	235	DQ62
26	V <sub>SS</sub>	146	DM2	56	V <sub>DDQ</sub>	176	A12	85	V <sub>SS</sub>	205	DQ38	116	DQ58	236	DQ63
27	DQS2	147	NC	57	A11	177	A9	86	DQ34	206	DQ39	117	DQ59	237	V <sub>SS</sub>
28	DQS2	148	V <sub>SS</sub>	58	A7	178	V <sub>DD</sub>	87	DQ35	207	V <sub>SS</sub>	118	V <sub>SS</sub>	238	VDDSPD
29	V <sub>SS</sub>	149	DQ22	59	V <sub>DD</sub>	179	A8	88	V <sub>SS</sub>	208	DQ44	119	SDA	239	SA0
30	DQ18	150	DQ23	60	A5	180	A6	89	DQ40	209	DQ45	120	SCL	240	SA1
								90	DQ41	210	V <sub>SS</sub>				

NC = No Connect, RFU = Reserved for Future Use

1. Pin173 Pin174 are reserved for 2Gb/4Gb comp. base Unbuffered DIMM.

2. The TEST pin is reserved for bus analysis tools and is not connected on standard memory module products (DIMMs.)

### Pin Description

Pin Name	Description	Pin Name	Description
A0-A12	DDR2 SDRAM address bus	CK0, CK1, CK2	DDR2 SDRAM clocks (positive line of differential pair)
BA0, BA1	DDR2 SDRAM bank select	CK0, CK1, CK2	DDR2 SDRAM clocks (negative line of differential pair)
RAS	DDR2 SDRAM row address strobe	SCL	I <sup>2</sup> C serial bus clock for EEPROM
CAS	DDR2 SDRAM column address strobe	SDA	I <sup>2</sup> C serial bus data line for EEPROM
WE	DDR2 SDRAM write enable	SA0-SA2	I <sup>2</sup> C serial address select for EEPROM
S0, S1	DIMM Rank Select Lines	V <sub>DD</sub> *	DDR2 SDRAM core power supply
CKE0,CKE1	DDR2 SDRAM clock enable lines	V <sub>DDQ</sub> *	DDR2 SDRAM I/O Driver power supply
ODT0, ODT1	On-die termination control lines	V <sub>REF</sub>	DDR2 SDRAM I/O reference supply
DQ0 - DQ63	DIMM memory data bus	V <sub>SS</sub>	Power supply return (ground)
CB0 - CB7	DIMM ECC check bits	V <sub>DDSPD</sub>	Serial EEPROM positive power supply
DQS0 - DQS8	DDR2 SDRAM data strobes	NC	Spare Pins(no connect)
DM(0-8)	DDR2 SDRAM data masks	RESET	Not used on UDIMM
DQS0-DQS8	DDR2 SDRAM differential data strobes	TEST	Used by memory bus analysis tools (unused on memory DIMMs)

\* The VDD and VDDQ pins are tied to the single power-plane on PCB.

## 256MB, 512MB Unbuffered DIMMs

## DDR2 SDRAM

### Input/Output Functional Description

Symbol	Type	Function
CK0-CK2 CK0-CK2	Input	CK and $\overline{CK}$ are differential clock inputs. All the SDRAM addr/cntl inputs are sampled on the crossing of positive edge of CK and negative edge of $\overline{CK}$ . Output (read) data is reference to the crossing of CK and $\overline{CK}$ (Both directions of crossing)
CKE0-CKE1	Input	Activates the SDRAM CK signal when high and deactivates the CK Signal When low. By deactivating the clocks, CKE low initiates the Powe Down mode, or the Self-Refresh mode
$\overline{S0}$ - $\overline{S1}$	Input	Enables the associated SDRAM command decoder when low and disables the command decoder when high. When the command decoder is disabled, new command are ignored but previous operations continue. This signal provides for external rank selection on systems with multiple ranks
RAS, CAS, WE	Input	RAS, CAS, and WE (ALONG WITH CS) define the command being entered.
ODT0-ODT1	Input	When high, termination resistance is enabled for all DQ, $\overline{DQ}$ and DM pins, assuming the function is enabled in the Extended Mode Register Set (EMRS).
V <sub>REF</sub>	Supply	Reference voltage for SSTL 18 inputs.
V <sub>DDQ</sub>	Supply	Power supply for the DDR II SDRAM output buffers to provide improved noise immunity. For all current DDR2 unbuffered DIMM designs, VDDQ shares the same power plane as VDD pins.
BA0-BA1	Input	Selects which SDRAM BANK of four is activated.
A0-A13	Input	During a Bank Activate command cycle, Address input defines the row address (RA0-RA13)  During a Read or Write command cycle, Address input defines the column address. In addition to the column address, AP is used to invoke autoprecharge operation at the end of the burst read or write cycle. If AP is high, autoprecharge is selected and BA0, BA1 defines the bank to be precharged. If AP is low, autoprecharge is disabled. During a precharge command cycle, AP is used in conjunction with BA0, BA1 to control which bank(s) to precharge. If AP is high, all banks will be precharged regardless of the state of BA0, BA1. If AP is low, BA0, BA1 are used to define which bank to precharge.
DQ0-DQ63 CB0-CB7	In/Out	Data and Check Bit Input/Output pins.
DM0-DM8	Input	DM is an input mask signal for write data. Input data is masked when DM is sampled High coincident with that input data during a write access. DM is sampled on both edges of DQS. Although DM pins are input only, the DM loading matches the DQ and DQS loading.
V <sub>DD</sub> , V <sub>SS</sub>	Supply	Power and ground for DDR2 SDRAM input buffers, and core logic. VDD and VDDQ pins are tied to V <sub>DD</sub> /V <sub>DDQ</sub> planes on these modules.
$\overline{DQS0}$ - $\overline{DQS8}$ $\overline{DQS0}$ - $\overline{DQS8}$	In/Out	Data strobe for input and output data. For Rawcards using x16 organized DRAMs DQ0-7 connect to the LDQS pin of the DRAMs and DQ8-17 connect to the UDQS pin of the DRAM
SA0-SA2	Input	These signals and tied at the system planar to either V <sub>SS</sub> or V <sub>DD</sub> to configure the serial SPD EEPROM address range.
SDA	In/Out	This bidirectional pin is used to transfer data into or out of the SPD EEPROM. A resistor must be connected from the SDA bus line to VDD to act as a pullup on the system board.
SCL	Input	This signal is used to clock data into and out of the SPD EEPROM. A resistor may be connected from the SCL bus time to VDD to act as a pullup on the system board.
V <sub>DD</sub> SPD	Supply	Power supply for SPD EEPROM. This supply is separate from the V <sub>DD</sub> /V <sub>DDQ</sub> power plane. EEPROM supply is operable from 1.7V to 3.6V.

256MB, 512MB Unbuffered DIMMs

DDR2 SDRAM

Functional Block Diagram: 256MB, 32Mx64 Module(Populated as 1 rank of x8 DDR2 SDRAMs)  
M378T3253FG(Z)3 / M378T3253FG(Z)0

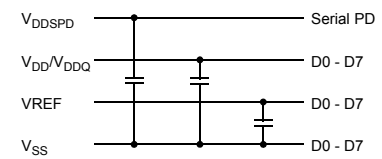
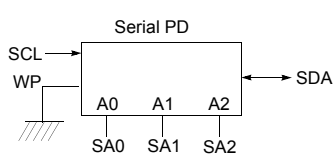
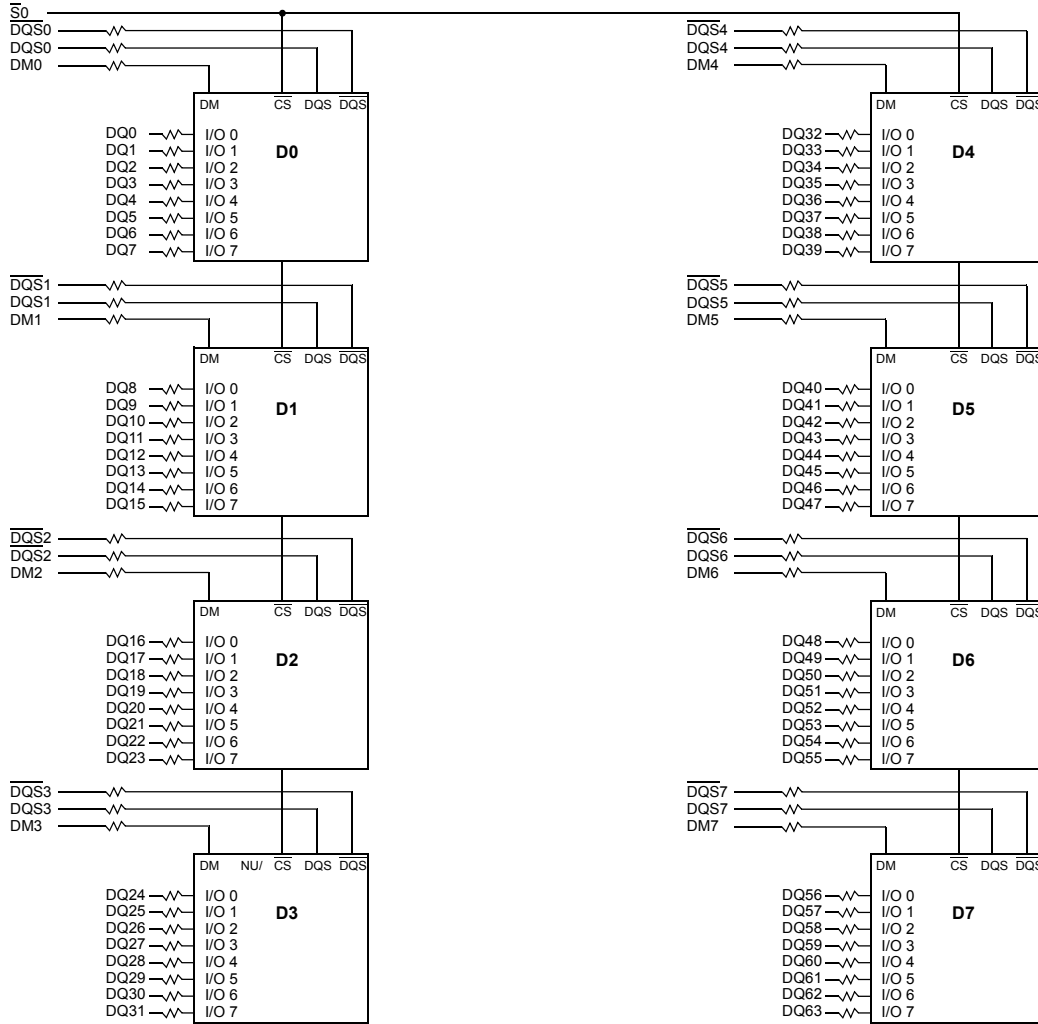

- BA0 - BA1 → BA0-BA1 : DDR2 SDRAMs D0 - D7
- A0 - A12 → A0-A12 : DDR2 SDRAMs D0 - D7
- RAS → RAS : DDR2 SDRAMs D0 - D7
- CAS → CAS : DDR2 SDRAMs D0 - D7
- CKE0 → CKE : DDR2 SDRAMs D0 - D7
- WE → WE : DDR2 SDRAMs D0 - D7
- ODT0 → ODT : DDR2 SDRAMs D0 - D7

* Clock Wiring	
Clock Input	DDR2 SDRAMs
*CK0/CK0	2 DDR2 SDRAMs
*CK1/CK1	3 DDR2 SDRAMs
*CK2/CK2	3 DDR2 SDRAMs

\*Wire per Clock Loading Table/Wiring Diagrams

- Notes :
1. DQ,DM, DQS/DQS-bar resistors : 22 Ohms ± 5%.
  2. BAx, Ax, RAS, CAS, WE resistors : 5.1 Ohms ± 5%.

256MB, 512MB Unbuffered DIMMs

DDR2 SDRAM

Functional Block Diagram: 256MB, 32Mx72 ECC Module(Populated as 1 rank of x8 DDR2 SDRAMs)  
M391T3253FG(Z)3 / M391T3253FG(Z)0

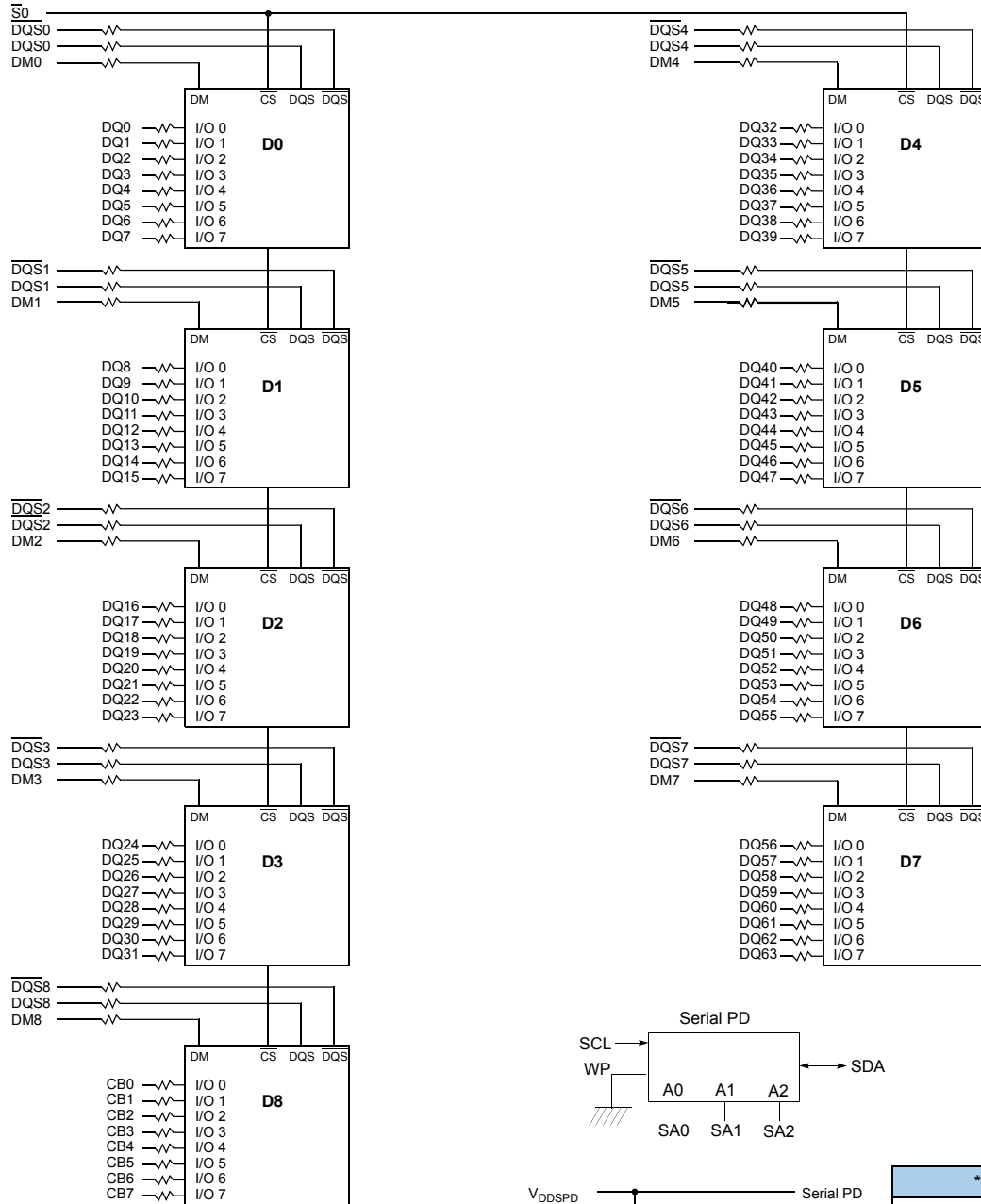

- BA0 - BA1 → BA0-BA1 : DDR2 SDRAMs D0 - D8
- A0 - A12 → A0-A12 : DDR2 SDRAMs D0 - D8
- $\overline{\text{RAS}}$  →  $\overline{\text{RAS}}$  : DDR2 SDRAMs D0 - D8
- $\overline{\text{CAS}}$  →  $\overline{\text{CAS}}$  : DDR2 SDRAMs D0 - D8
- CKE0 → CKE : DDR2 SDRAMs D0 - D8
- $\overline{\text{WE}}$  →  $\overline{\text{WE}}$  : DDR2 SDRAMs D0 - D8
- ODT0 → ODT : DDR2 SDRAMs D0 - D8

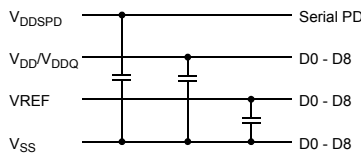
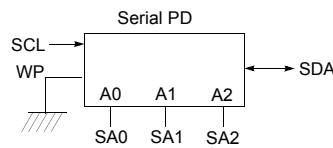

* Clock Wiring	
Clock Input	DDR2 SDRAMs
*CK0/ $\overline{\text{CK0}}$	3 DDR2 SDRAMs
*CK1/ $\overline{\text{CK1}}$	3 DDR2 SDRAMs
*CK2/ $\overline{\text{CK2}}$	3 DDR2 SDRAMs

\*Wire per Clock Loading Table/Wiring Diagrams

- Notes :
- DQ,DM,  $\overline{\text{DQS}}/\overline{\text{DQS}}$  resistors : 22 Ohms  $\pm$  5%.
  - BAX, Ax, RAS, CAS, WE resistors : 5.1 Ohms  $\pm$  5%.

256MB, 512MB Unbuffered DIMMs

DDR2 SDRAM

Functional Block Diagram: 512B, 64Mx64 Module (Populated as 2 ranks of x8 DDR2 SDRAMs)  
M378T6453FG(Z)3 / M378T6453FG(Z)0

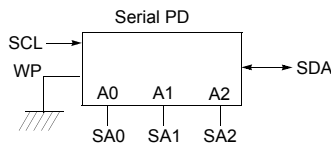
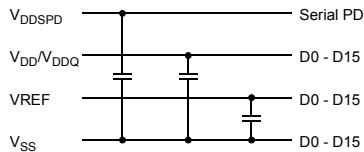
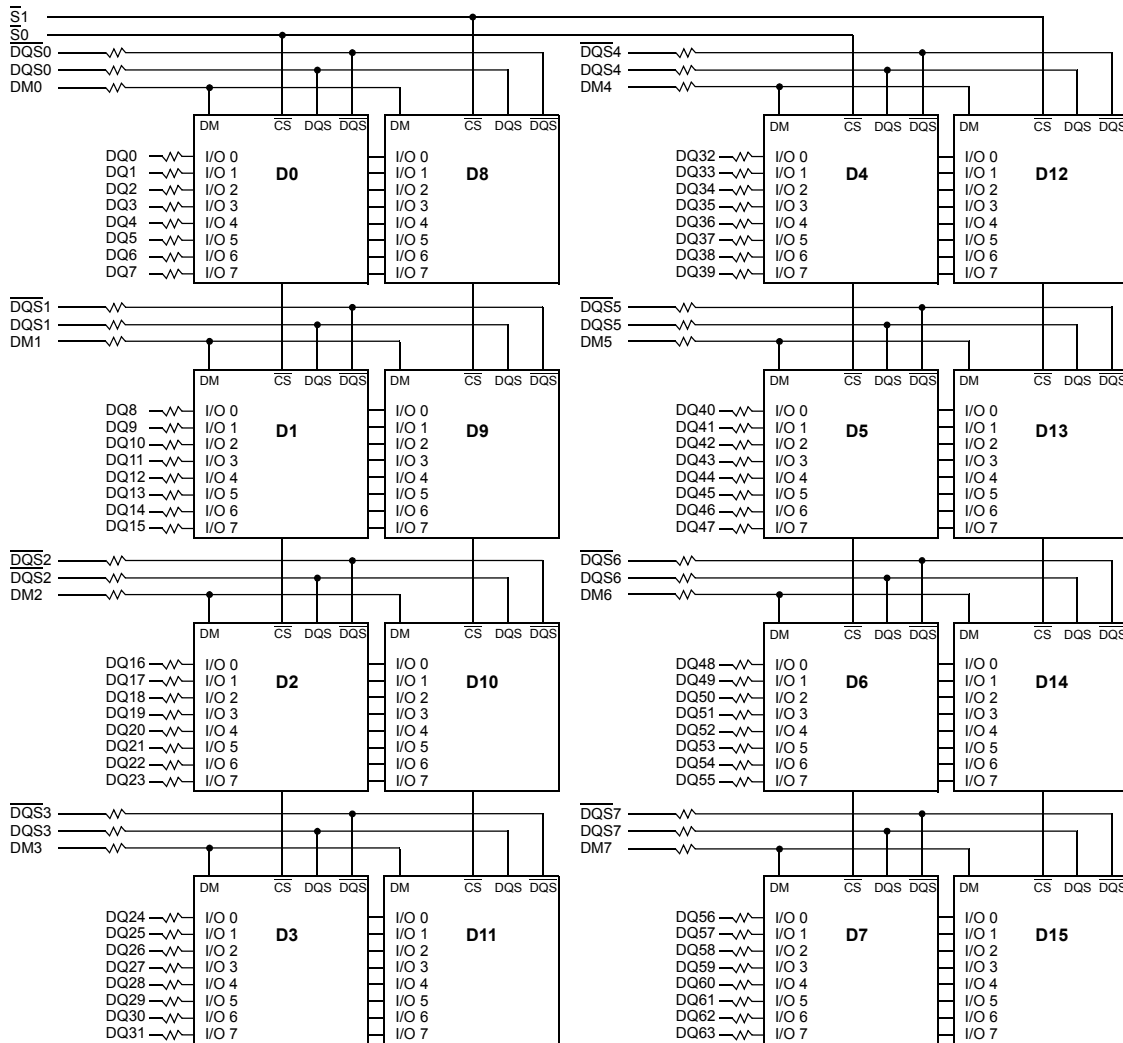

- BA0 - BA1 → BA0-BA1 : DDR2 SDRAMs D0 - D15
- A0 - A12 → A0-A12 : DDR2 SDRAMs D0 - D15
- CKE0 → CKE : DDR2 SDRAMs D0 - D7
- CKE1 → CKE : DDR2 SDRAMs D8 - D15
- RAS → RAS : DDR2 SDRAMs D0 - D15
- CAS → CAS : DDR2 SDRAMs D0 - D15
- WE → WE : DDR2 SDRAMs D0 - D15
- ODT0 → ODT : DDR2 SDRAMs D0 - D7
- ODT1 → ODT : DDR2 SDRAMs D8 - D15

* Clock Wiring	
Clock Input	DDR2 SDRAMs
*CK0/CK0	4 DDR2 SDRAMs
*CK1/CK1	6 DDR2 SDRAMs
*CK2/CK2	6 DDR2 SDRAMs

\*Wire per Clock Loading Table/Wiring Diagrams

Notes :

1. DQ,DM, DQS/DQS resistors : 22 Ohms ± 5%.
2. BAx, Ax, RAS, CAS, WE resistors : 3 Ohms ± 5%.



256MB, 512MB Unbuffered DIMMs

DDR2 SDRAM

Functional Block Diagram: 512MB, 64Mx72 ECC Module (Populated as 2 ranks of x8 DDR2 SDRAMs)  
M391T6453FG(Z)3 / M391T6453FG(Z)0

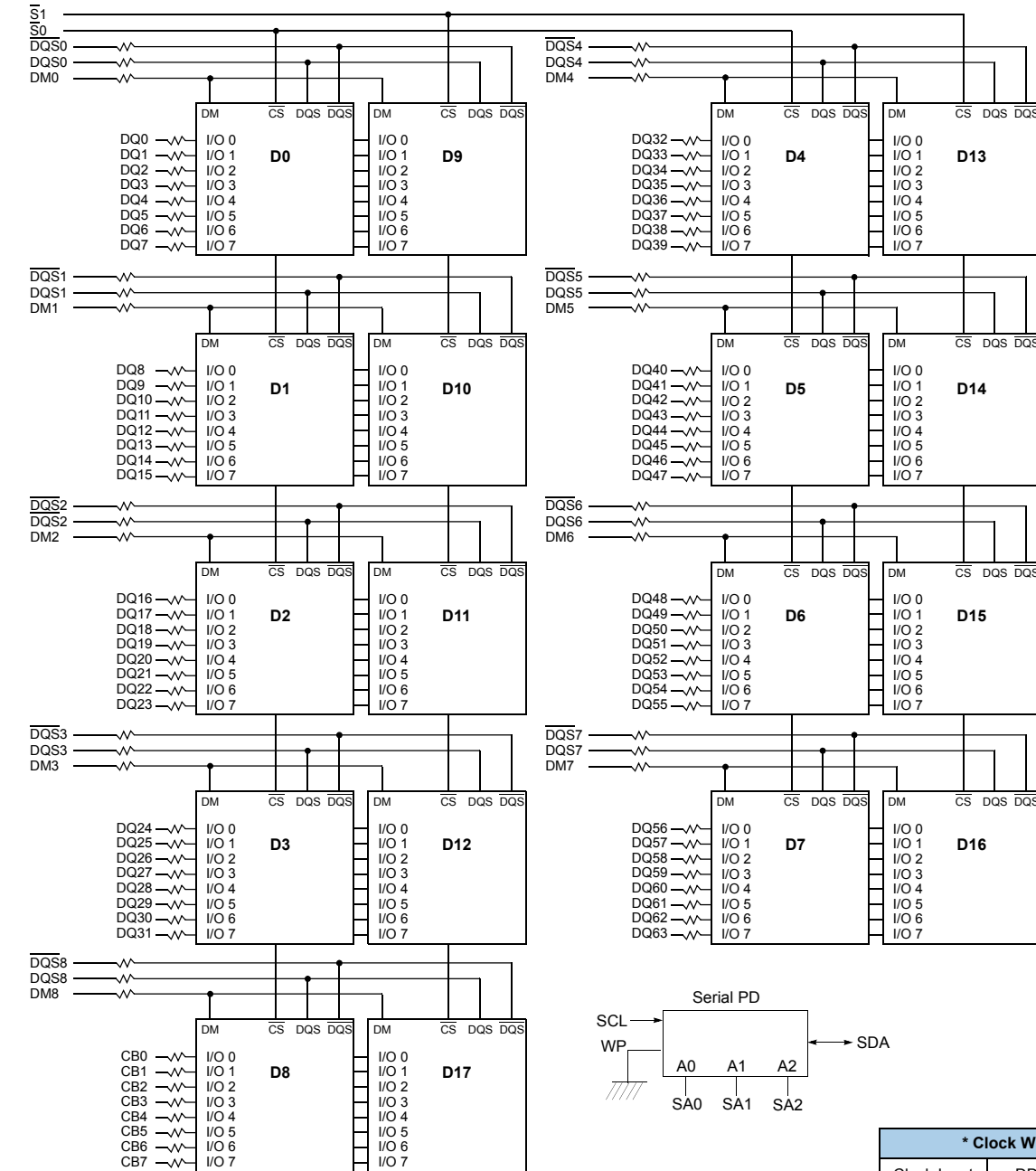

- BA0 - BA1 → BA0-BA1 : DDR2 SDRAMs D0 - D17
- A0 - A12 → A0-A12 : DDR2 SDRAMs D0 - D17
- CKE0 → CKE : DDR2 SDRAMs D0 - D8
- CKE1 → CKE : DDR2 SDRAMs D9 - D17
- RAS → RAS : DDR2 SDRAMs D0 - D17
- CAS → CAS : DDR2 SDRAMs D0 - D17
- WE → WE : DDR2 SDRAMs D0 - D17
- ODT0 → ODT : DDR2 SDRAMs D0 - D8
- ODT1 → ODT : DDR2 SDRAMs D9 - D17

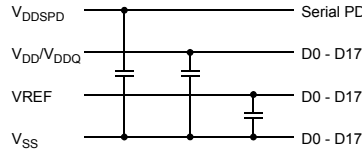

* Clock Wiring	
Clock Input	DDR2 SDRAMs
*CK0/CK0	6 DDR2 SDRAMs
*CK1/CK1	6 DDR2 SDRAMs
*CK2/CK2	6 DDR2 SDRAMs

\*Wire per Clock Loading Table/Wiring Diagrams

- Notes :
- DQ, DM, DQS/DQS resistors : 22 Ohms ± 5%.
  - BAX, Ax, RAS, CAS, WE resistors : 3 Ohms ± 5%.

**256MB, 512MB Unbuffered DIMMs****DDR2 SDRAM****Absolute Maximum DC Ratings**

Symbol	Parameter	Rating	Units	Notes
V <sub>DD</sub>	Voltage on V <sub>DD</sub> pin relative to V <sub>SS</sub>	- 1.0 V ~ 2.3 V	V	1
V <sub>DDQ</sub>	Voltage on V <sub>DDQ</sub> pin relative to V <sub>SS</sub>	- 0.5 V ~ 2.3 V	V	1
V <sub>DDL</sub>	Voltage on V <sub>DDL</sub> pin relative to V <sub>SS</sub>	- 0.5 V ~ 2.3 V	V	1
V <sub>IN</sub> , V <sub>OUT</sub>	Voltage on any pin relative to V <sub>SS</sub>	- 0.5 V ~ 2.3 V	V	1
T <sub>STG</sub>	Storage Temperature	-55 to +100	°C	1, 2

Note :

- Stresses greater than those listed under "Absolute Maximum Ratings" may cause permanent damage to the device. This is a stress rating only and functional operation of the device at these or any other conditions above those indicated in the operational sections of this specification is not implied. Exposure to absolute maximum rating conditions for extended periods may affect reliability.
- Storage Temperature is the case surface temperature on the center/top side of the DRAM. For the measurement conditions, please refer to JESD51-2 standard.

**AC & DC Operating Conditions**

Recommended DC Operating Conditions (SSTL - 1.8)

Symbol	Parameter	Rating			Units	Notes
		Min.	Typ.	Max.		
V <sub>DD</sub>	Supply Voltage	1.7	1.8	1.9	V	
V <sub>DDL</sub>	Supply Voltage for DLL	1.7	1.8	1.9	V	4
V <sub>DDQ</sub>	Supply Voltage for Output	1.7	1.8	1.9	V	4
V <sub>REF</sub>	Input Reference Voltage	0.49*V <sub>DDQ</sub>	0.50*V <sub>DDQ</sub>	0.51*V <sub>DDQ</sub>	mV	1,2
V <sub>TT</sub>	Termination Voltage	V <sub>REF</sub> -0.04	V <sub>REF</sub>	V <sub>REF</sub> +0.04	V	3

Note : There is no specific device V<sub>DD</sub> supply voltage requirement for SSTL-1.8 compliance. However under all conditions V<sub>DDQ</sub> must be less than or equal to V<sub>DD</sub>.

- The value of V<sub>REF</sub> may be selected by the user to provide optimum noise margin in the system. Typically the value of V<sub>REF</sub> is expected to be about 0.5 x V<sub>DDQ</sub> of the transmitting device and V<sub>REF</sub> is expected to track variations in V<sub>DDQ</sub>.
- Peak to peak AC noise on V<sub>REF</sub> may not exceed +/-2% V<sub>REF</sub>(DC).
- V<sub>TT</sub> of transmitting device must track V<sub>REF</sub> of receiving device.
- AC parameters are measured with V<sub>DD</sub>, V<sub>DDQ</sub> and V<sub>DDL</sub> tied together.

## 256MB, 512MB Unbuffered DIMMs

## DDR2 SDRAM

### Operating Temperature Condition

Symbol	Parameter	Rating	Units	Notes
TOPER	Operating Temperature	0 to 95	°C	1, 2, 3

Note :

- Operating Temperature is the case surface temperature on the center/top side of the DRAM. For the measurement conditions, please refer to JESD51.2 standard.
- At 0 - 85 °C, operation temperature range are the temperature which all DRAM specification will be supported.
- At 85 - 95 °C operation temperature range, doubling refresh commands in frequency to a 32ms period ( tREFI=3.9 us ) is required, and to enter to self refresh mode at this temperature range, an EMRS command is required to change internal refresh rate.

### Input DC Logic Level

Symbol	Parameter	Min.	Max.	Units	Notes
V <sub>IH</sub> (DC)	DC input logic high	V <sub>REF</sub> + 0.125	V <sub>DDQ</sub> + 0.3	V	
V <sub>IL</sub> (DC)	DC input logic low	V <sub>DDQ</sub> - 0.3	V <sub>REF</sub> - 0.125	V	

### Input AC Logic Level

Symbol	Parameter	DDR2-400, DDR2-533		DDR2-667		Units	Notes
		Min.	Max.	Min.	Max.		
V <sub>IH</sub> (AC)	AC input logic high	V <sub>REF</sub> + 0.250	-	V <sub>REF</sub> + 0.200		V	
V <sub>IL</sub> (AC)	AC input logic low	-	V <sub>REF</sub> - 0.250		V <sub>REF</sub> - 0.200	V	

### AC Input Test Conditions

Symbol	Condition	Value	Units	Notes
V <sub>REF</sub>	Input reference voltage	0.5 * V <sub>DDQ</sub>	V	1
V <sub>SWING(MAX)</sub>	Input signal maximum peak to peak swing	1.0	V	1
SLEW	Input signal minimum slew rate	1.0	V/ns	2, 3

Notes:

- Input waveform timing is referenced to the input signal crossing through the V<sub>IH/IL</sub>(AC) level applied to the device under test.
- The input signal minimum slew rate is to be maintained over the range from V<sub>REF</sub> to V<sub>IH</sub>(AC) min for rising edges and the range from V<sub>REF</sub> to V<sub>IL</sub>(AC) max for falling edges as shown in the below figure.
- AC timings are referenced with input waveforms switching from V<sub>IL</sub>(AC) to V<sub>IH</sub>(AC) on the positive transitions and V<sub>IH</sub>(AC) to V<sub>IL</sub>(AC) on the negative transitions.

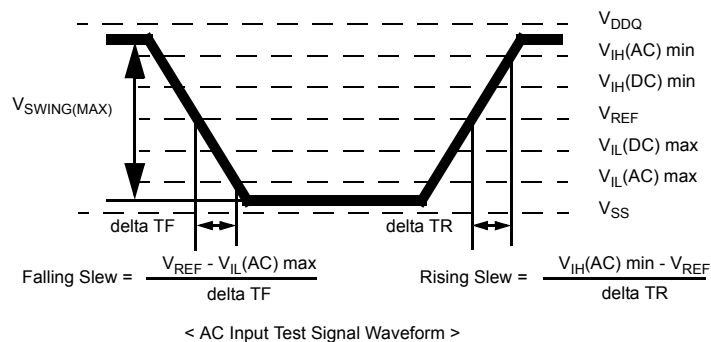

## 256MB, 512MB Unbuffered DIMMs

## DDR2 SDRAM

### IDD Specification Parameters Definition

(IDD values are for full operating range of Voltage and Temperature)

Symbol	Proposed Conditions	Units	Notes
IDD0	<b>Operating one bank active-precharge current;</b> tCK = tCK(IDD), tRC = tRC(IDD), tRAS = tRASmin(IDD); CKE is HIGH, CS\ is HIGH between valid commands; Address bus inputs are SWITCHING; Data bus inputs are SWITCHING	mA	
IDD1	<b>Operating one bank active-read-precharge current;</b> IOUT = 0mA; BL = 4, CL = CL(IDD), AL = 0; tCK = tCK(IDD), tRC = tRC(IDD), tRAS = tRASmin(IDD), tRCD = tRCD(IDD); CKE is HIGH, CS\ is HIGH between valid commands; Address bus inputs are SWITCHING; Data pattern is same as IDD4W	mA	
IDD2P	<b>Precharge power-down current;</b> All banks idle; tCK = tCK(IDD); CKE is LOW; Other control and address bus inputs are STABLE; Data bus inputs are FLOATING	mA	
IDD2Q	<b>Precharge quiet standby current;</b> All banks idle; tCK = tCK(IDD); CKE is HIGH, CS\ is HIGH; Other control and address bus inputs are STABLE; Data bus inputs are FLOATING	mA	
IDD2N	<b>Precharge standby current;</b> All banks idle; tCK = tCK(IDD); CKE is HIGH, CS\ is HIGH; Other control and address bus inputs are SWITCHING; Data bus inputs are SWITCHING	mA	
IDD3P	<b>Active power-down current;</b> All banks open; tCK = tCK(IDD); CKE is LOW; Other control and address bus inputs are STABLE; Data bus inputs are FLOATING	Fast PDN Exit MRS(12) = 0mA	mA
		Slow PDN Exit MRS(12) = 1mA	mA
IDD3N	<b>Active standby current;</b> All banks open; tCK = tCK(IDD), tRAS = tRASmax(IDD), tRP = tRP(IDD); CKE is HIGH, CS\ is HIGH between valid commands; Other control and address bus inputs are SWITCHING; Data bus inputs are SWITCHING	mA	
IDD4W	<b>Operating burst write current;</b> All banks open, Continuous burst writes; BL = 4, CL = CL(IDD), AL = 0; tCK = tCK(IDD), tRAS = tRASmax(IDD), tRP = tRP(IDD); CKE is HIGH, CS\ is HIGH between valid commands; Address bus inputs are SWITCHING; Data bus inputs are SWITCHING	mA	
IDD4R	<b>Operating burst read current;</b> All banks open, Continuous burst reads, IOUT = 0mA; BL = 4, CL = CL(IDD), AL = 0; tCK = tCK(IDD), tRAS = tRASmax(IDD), tRP = tRP(IDD); CKE is HIGH, CS\ is HIGH between valid commands; Address bus inputs are SWITCHING; Data pattern is same as IDD4W	mA	
IDD5B	<b>Burst auto refresh current;</b> tCK = tCK(IDD); Refresh command at every tRFC(IDD) interval; CKE is HIGH, CS\ is HIGH between valid commands; Other control and address bus inputs are SWITCHING; Data bus inputs are SWITCHING	mA	
IDD6	<b>Self refresh current;</b> CK and CK\ at 0V; CKE ≤ 0.2V; Other control and address bus inputs are FLOATING; Data bus inputs are FLOATING	Normal	mA
		Low Power	mA
IDD7	<b>Operating bank interleave read current;</b> All bank interleaving reads, IOUT = 0mA; BL = 4, CL = CL(IDD), AL = tRCD(IDD)-1*tCK(IDD); tCK = tCK(IDD), tRC = tRC(IDD), tRRD = tRRD(IDD), tFAW = tFAW(IDD), tRCD = 1*tCK(IDD); CKE is HIGH, CS\ is HIGH between valid commands; Address bus inputs are STABLE during DESELECTs; Data pattern is same as IDD4R; Refer to the following page for detailed timing conditions	mA	

## 256MB, 512MB Unbuffered DIMMs

## DDR2 SDRAM

### Operating Current Table(1-1) (T<sub>A</sub>=0°C, VDD= 1.9V)

#### M378T3253FG(Z)3 / M378T3253FG(Z)0 : 256MB(32Mx8 \*8) Module

Symbol	E6 (DDR2-667@CL=5)	D5 (DDR2-533@CL=4)	CC (DDR2-400@CL=3)	Unit	Notes
IDD0	840	800	760	mA	
IDD1	920	880	800	mA	
IDD2P	64	64	64	mA	
IDD2Q	240	200	200	mA	
IDD2N	280	240	240	mA	
IDD3P-F	280	240	240	mA	
IDD3P-S	120	120	120	mA	
IDD3N	600	560	520	mA	
IDD4W	1,680	1,400	1,080	mA	
IDD4R	1,480	1,280	1,040	mA	
IDD5B	1,360	1,320	1,280	mA	
IDD6	Normal	40	40	mA	
IDD7		2,120	2,040	mA	

\* Module IDD was calculated on the basis of component IDD and can be differently measured according to DQ loading cap.

#### M378T6453FG(Z)3 / M378T6453FG(Z)0 : 512MB(32Mx8 \*16) Module

Symbol	E6 (DDR2-667@CL=5)	D5 (DDR2-533@CL=4)	CC (DDR2-400@CL=3)	Unit	Notes
IDD0	1,440	1,360	1,280	mA	
IDD1	1,520	1,440	1,320	mA	
IDD2P	128	128	128	mA	
IDD2Q	480	400	400	mA	
IDD2N	560	480	480	mA	
IDD3P-F	560	480	480	mA	
IDD3P-S	240	240	240	mA	
IDD3N	1,200	1,120	1,040	mA	
IDD4W	2,280	1,960	1,600	mA	
IDD4R	2,080	1,840	1,560	mA	
IDD5B	1,960	1,880	1,800	mA	
IDD6	Normal	80	80	mA	
IDD7		2,720	2,560	mA	

\* Module IDD was calculated on the basis of component IDD and can be differently measured according to DQ loading cap.

**256MB, 512MB Unbuffered DIMMs****DDR2 SDRAM****Operating Current Table(1-2)** (T<sub>A</sub>=0°C, VDD= 1.9V)**M391T3253FG(Z)3 / M391T3253FG(Z)0 : 256MB(32Mx8 \*9) ECC Module**

Symbol	E6 (DDR2-667@CL=5)	D5 (DDR2-533@CL=4)	CC (DDR2-400@CL=3)	Unit	Notes
IDD0	945	900	855	mA	
IDD1	1,035	990	900	mA	
IDD2P	72	72	72	mA	
IDD2Q	270	225	225	mA	
IDD2N	315	270	270	mA	
IDD3P-F	315	270	270	mA	
IDD3P-S	135	135	135	mA	
IDD3N	675	630	585	mA	
IDD4W	1,890	1,575	1,215	mA	
IDD4R	1,665	1,440	1,170	mA	
IDD5B	1,530	1,485	1,440	mA	
IDD6	Normal	45	45	mA	
IDD7		2,385	2,295	mA	

\* Module IDD was calculated on the basis of component IDD and can be differently measured according to DQ loading cap.

**M391T6453FG(Z)3 / M391T6453FG(Z)0 : 512MB(32Mx8 \*18) ECC Module**

Symbol	E6 (DDR2-667@CL=5)	D5 (DDR2-533@CL=4)	CC (DDR2-400@CL=3)	Unit	Notes
IDD0	1,620	1,530	1,440	mA	
IDD1	1,710	1,620	1,485	mA	
IDD2P	144	144	144	mA	
IDD2Q	540	450	450	mA	
IDD2N	630	540	540	mA	
IDD3P-F	630	540	540	mA	
IDD3P-S	270	270	270	mA	
IDD3N	1,350	1,260	1,170	mA	
IDD4W	2,565	2,205	1,800	mA	
IDD4R	2,340	2,070	1,755	mA	
IDD5B	2,205	2,115	2,025	mA	
IDD6	Normal	90	90	mA	
IDD7		3,060	2,925	mA	

\* Module IDD was calculated on the basis of component IDD and can be differently measured according to DQ loading cap.

**256MB, 512MB Unbuffered DIMMs**

**DDR2 SDRAM**

**Input/Output Capacitance**(V<sub>DD</sub>=1.8V, V<sub>DDQ</sub>=1.8V, T<sub>A</sub>=25°C)

Parameter	Symbol	Min	Max	Min	Max	Units
Non-ECC		M378T3253FG(Z)3 M378T3253FG(Z)0		M378T6453FG(Z)3 M378T6453FG(Z)0		
Input capacitance, CK and $\overline{CK}$	CCK0	-	24	-	26	pF
	CCK1	-	25	-	28	
	CCK2	-	25	-	28	
Input capacitance, CKE and $\overline{CS}$	Cl <sub>1</sub>	-	42	-	42	
Input capacitance, Addr, $\overline{RAS}$ , $\overline{CAS}$ , $\overline{WE}$	Cl <sub>2</sub>	-	42	-	42	
Input/output capacitance, DQ, DM, DQS, $\overline{DQS}$	CIO	-	6	-	10	
ECC	Symbol	M391T3253FG(Z)3 M391T3253FG(Z)0		M391T6453FG(Z)3 M391T6453FG(Z)0		Units
Input capacitance, CK and $\overline{CK}$	CCK0	-	25	-	28	pF
	CCK1	-	25	-	28	
	CCK2	-	25	-	28	
Input capacitance, CKE and $\overline{CS}$	Cl <sub>1</sub>	-	44	-	44	
Input capacitance, Addr, $\overline{RAS}$ , $\overline{CAS}$ , $\overline{WE}$	Cl <sub>2</sub>	-	44	-	44	
Input/output capacitance, DQ, DM, DQS, $\overline{DQS}$	CIO	-	6	-	10	

\* DM is internally loaded to match DQ and DQS identically.

## 256MB, 512MB Unbuffered DIMMs

## DDR2 SDRAM

### Electrical Characteristics & AC Timing for DDR2-667/533/400 SDRAM

(0 °C ≤ T<sub>CASE</sub> ≤ 95 °C; V<sub>DDQ</sub> = 1.8V ± 0.1V; V<sub>DD</sub> = 1.8V ± 0.1V)

#### Refresh Parameters by Device Density

Parameter	Symbol	256Mb	512Mb	1Gb	2Gb	4Gb	Units	
Refresh to active/Refresh command time	tRFC	75	105	127.5	195	tbd	ns	
Average periodic refresh interval	tREFI	0 °C ≤ T <sub>CASE</sub> ≤ 85°C	7.8	7.8	7.8	7.8	7.8	μs
		85 °C < T <sub>CASE</sub> ≤ 95°C	3.9	3.9	3.9	3.9	3.9	μs

#### Speed Bins and CL, tRCD, tRP, tRC and tRAS for Corresponding Bin

Speed	DDR2-667(E6)		DDR2-533(D5)		DDR2-400(CC)		Units
Bin (CL - tRCD - tRP)	5 - 5 - 5		4 - 4 - 4		3 - 3 - 3		
Parameter	min	max	min	max	min	max	
tCK, CL=3	5	8	5	8	5	8	ns
tCK, CL=4	3.75	8	3.75	8	5	8	ns
tCK, CL=5	3	8	-	-	-	-	ns
tRCD	15		15		15		ns
tRP	15		15		15		ns
tRC	54		55		55		ns
tRAS	39	70000	40	70000	40	70000	ns

#### Timing Parameters by Speed Grade

(Refer to notes for informations related to this table at the bottom)

Parameter	Symbol	DDR2-667		DDR2-533		DDR2-400		Units	Notes
		min	max	min	max	min	max		
DQ output access time from CK/CK̄	tAC	-450	+450	-500	+500	-600	+600	ps	
DQS output access time from CK/CK̄	tDQSK	-400	+400	-450	+450	-500	+500	ps	
CK high-level width	tCH	0.45	0.55	0.45	0.55	0.45	0.55	tCK	
CK low-level width	tCL	0.45	0.55	0.45	0.55	0.45	0.55	tCK	
CK half period	tHP	min(tCL, tCH)	x	min(tCL, tCH)	x	min(tCL, tCH)	x	ps	20,21
Clock cycle time, CL=x	tCK	3000	8000	3750	8000	5000	8000	ps	24
DQ and DM input hold time	tDH	175	x	225	x	275	x	ps	15,16,17
DQ and DM input setup time	tDS	50	x	100	x	150	x	ps	15,16,17
Control & Address input pulse width for each input	tIPW	0.6	x	0.6	x	0.6	x	tCK	
DQ and DM input pulse width for each input	tDIPW	0.35	x	0.35	x	0.35	x	tCK	
Data-out high-impedance time from CK/CK̄	tHZ	x	tAC max	x	tAC max	x	tAC max	ps	
DQS low-impedance time from CK/CK̄	tLZ(DQS)	tAC min	tAC max	tAC min	tAC max	tAC min	tAC max	ps	27
DQ low-impedance time from CK/CK̄	tLZ(DQ)	2*tAC min	tAC max	2* tACmin	tAC max	2* tACmin	tAC max	ps	27
DQS-DQ skew for DQS and associated DQ signals	tDQSQ	x	250	x	300	x	350	ps	22
DQ hold skew factor	tQHS	x	350	x	400	x	450	ps	21
DQ/DQS output hold time from DQS	tQH	tHP - tQHS	x	tHP - tQHS	x	tHP - tQHS	x	ps	
Write command to first DQS latching transition	tDQSS	WL-0.25	WL+0.25	WL-0.25	WL+0.25	WL-0.25	WL+0.25	tCK	
DQS input high pulse width	tDQSH	0.35	x	0.35	x	0.35	x	tCK	



## 256MB, 512MB Unbuffered DIMMs

## DDR2 SDRAM

Parameter	Symbol	DDR2-667		DDR2-533		DDR2-400		Units	Notes
		min	max	min	max	min	max		
DQS input low pulse width	tDQSL	0.35	x	0.35	x	0.35	x	tCK	
DQS falling edge to CK setup time	tDSS	0.2	x	0.2	x	0.2	x	tCK	
DQS falling edge hold time from CK	tDSH	0.2	x	0.2	x	0.2	x	tCK	
Mode register set command cycle time	tMRD	2	x	2	x	2	x	tCK	
Write postamble	tWPST	0.4	0.6	0.4	0.6	0.4	0.6	tCK	19
Write preamble	tWPRE	0.35	x	0.35	x	0.35	x	tCK	
Address and control input hold time	tIH	275	x	375	x	475	x	ps	14,16,18
Address and control input setup time	tIS	200	x	250	x	350	x	ps	14,16,18
Read preamble	tRPRE	0.9	1.1	0.9	1.1	0.9	1.1	tCK	28
Read postamble	tRPST	0.4	0.6	0.4	0.6	0.4	0.6	tCK	28
Active to active command period for 1KB page size products	tRRD	7.5	x	7.5	x	7.5	x	ns	12
Active to active command period for 2KB page size products	tRRD	10	x	10	x	10	x	ns	12
Four Activate Window for 1KB page size products	tFAW	37.5		37.5		37.5		ns	
Four Activate Window for 2KB page size products	tFAW	50		50		50		ns	
CAS to CAS command delay	tCCD	2		2		2		tCK	
Write recovery time	tWR	15	x	15	x	15	x	ns	
Auto precharge write recovery + precharge time	tDAL	tWR+tRP	x	tWR+tRP	x	tWR+tRP	x	tCK	23
Internal write to read command delay	tWTR	7.5	x	7.5	x	10	x	ns	
Internal read to precharge command delay	tRTP	7.5		7.5		7.5		ns	11
Exit self refresh to a non-read command	tXSNR	tRFC + 10		tRFC + 10		tRFC + 10		ns	
Exit self refresh to a read command	tXSRD	200		200		200		tCK	
Exit precharge power down to any non-read command	tXP	2	x	2	x	2	x	tCK	
Exit active power down to read command	tXARD	2	x	2	x	2	x	tCK	9
Exit active power down to read command (Slow exit, Lower power)	tXARDS	6 - AL		6 - AL		6 - AL		tCK	9, 10
CKE minimum pulse width (high and low pulse width)	tCKE	3		3		3		tCK	
ODT turn-on delay	tAOND	2	2	2	2	2	2	tCK	
ODT turn-on	tAON	tAC(min)	tAC(max)+0.7	tAC(min)	tAC(max)+1	tAC(min)	tAC(max)+1	ns	13, 25
ODT turn-on(Power-Down mode)	tAONPD	tAC(min)+2	2tCK+tAC(max)+1	tAC(min)+2	2tCK+tAC(max)+1	tAC(min)+2	2tCK+tAC(max)+1	ns	
ODT turn-off delay	tAOFD	2.5	2.5	2.5	2.5	2.5	2.5	tCK	
ODT turn-off	tAOF	tAC(min)	tAC(max)+0.6	tAC(min)	tAC(max)+0.6	tAC(min)	tAC(max)+0.6	ns	26
ODT turn-off (Power-Down mode)	tAOFPD	tAC(min)+2	2.5tCK+tAC(max)+1	tAC(min)+2	2.5tCK+tAC(max)+1	tAC(min)+2	2.5tCK+tAC(max)+1	ns	
ODT to power down entry latency	tANPD	3		3		3		tCK	
ODT power down exit latency	tAXPD	8		8		8		tCK	
OCD drive mode output delay	tOIT	0	12	0	12	0	12	ns	
Minimum time clocks remains ON after CKE asynchronously drops LOW	tDelay	tIS+tCK+tIH		tIS+tCK+tIH		tIS+tCK+tIH		ns	24

# 256MB, 512MB Unbuffered DIMMs

# DDR2 SDRAM

Physical Dimensions: 32Mbx8 based 32Mx64/x72 Module(1 Rank)

M378T3253FG(Z)3 / M391T3253FG(Z)3

M378T3253FG(Z)0 / M391T3253FG(Z)0

Units : Millimeters

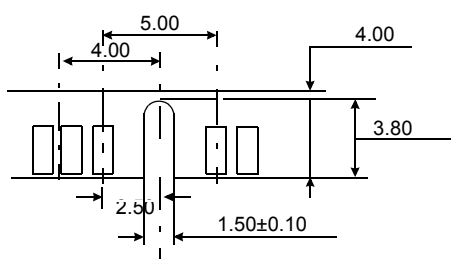
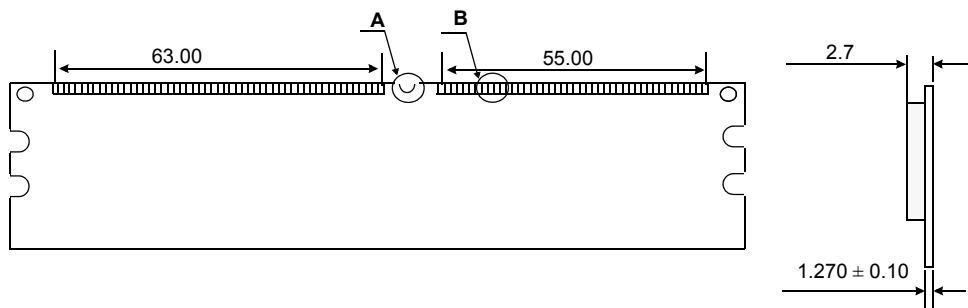
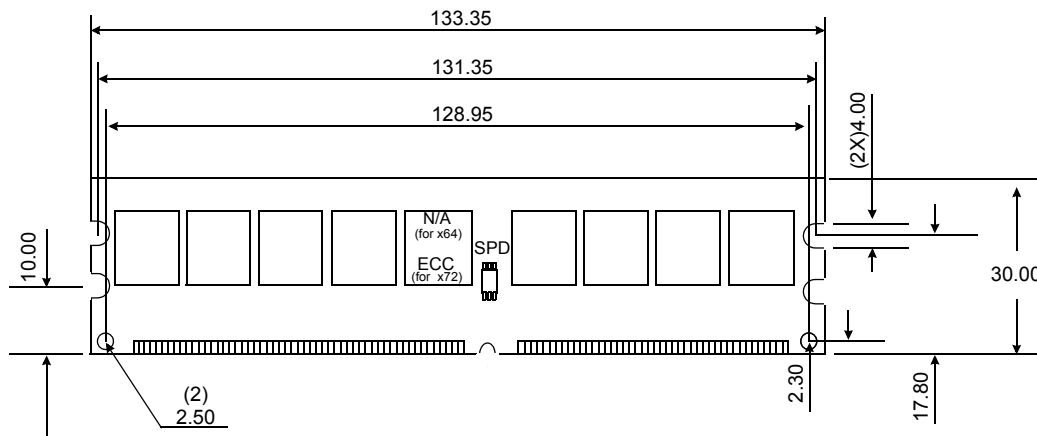

Detail A

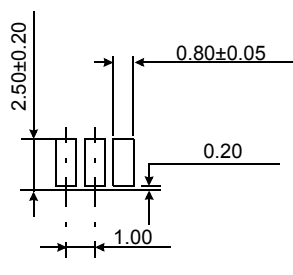

Detail B

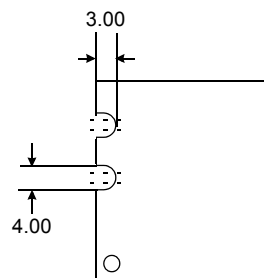

The used device is 32M x8 DDR2 SDRAM, FBGA.  
DDR2 SDRAM Part NO : K4T56083QF

# 256MB, 512MB Unbuffered DIMMs

# DDR2 SDRAM

Physical Dimensions: 32Mbx8 based 64Mx64/x72 Module(2 Ranks)

M378T6453FG(Z)3 / M391T6453FG(Z)3

M378T6453FG(Z)0 / M391T6453FG(Z)0

Units : Millimeters

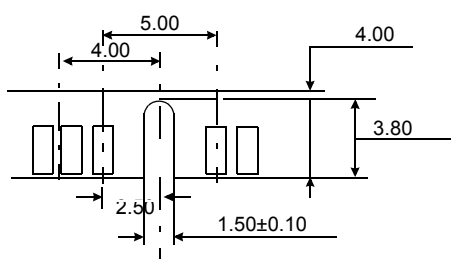
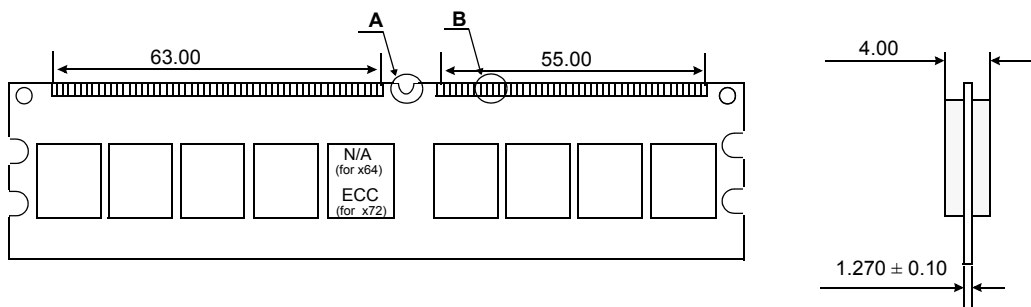
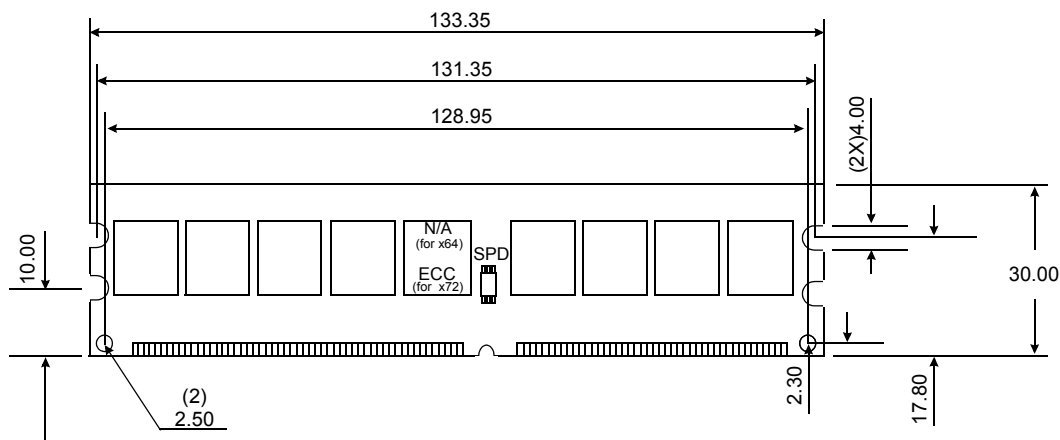

Detail A

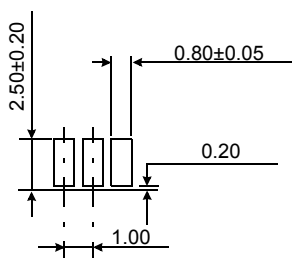

Detail B

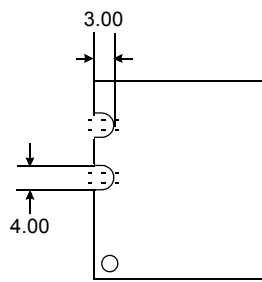

The used device is 32M x8 DDR2 SDRAM, FBGA.  
DDR2 SDRAM Part NO : K4T56083QF

**Revision History**

**Revision 1.0 (Jan. 2004)**

- Initial Release

**Revision 1.1 (Jun. 2004)**

- Added lead-free part number in the ordering information
- Changed IDD2P

**Revision 1.2 (Jan. 2005)**

- Revised tIH value of 667 speed

**Revision 1.3 (Aug. 2005)**

- Added Dummy Pad PCB product part number in ordering information