

DATA SHEET

# AA264-87, AA264-87LF: GaAs IC 4-Bit Digital Attenuator 2 dB LSB Positive Control 0.5–2 GHz

## Features

- Attenuation 2 dB steps to 30 dB with high accuracy
- Single positive control for each bit
- Low DC Power consumption
- Small, low-cost TSSOP-16 plastic package
- Available lead (Pb)-free and RoHS-compliant MSL-1 @ 260 °C per JEDEC J-STD-020

## Description

The AA264-87 is a 4-bit, single positive control GaAs IC FET digital attenuator in a low-cost TSSOP-16 package. The attenuator requires external DC blocking capacitors, positive supply voltage ( $V_S$ ) and four individual positive control voltages ( $V_1$ – $V_4$ ). The AA264-87 is particularly suited where high attenuation accuracy, low insertion loss and low intermodulation products are required. Typical applications include base station, wireless data and wireless local loop gain control circuits.

**NEW** Skyworks offers lead (Pb)-free, RoHS (Restriction of Hazardous Substances)-compliant packaging.



## Pin Out

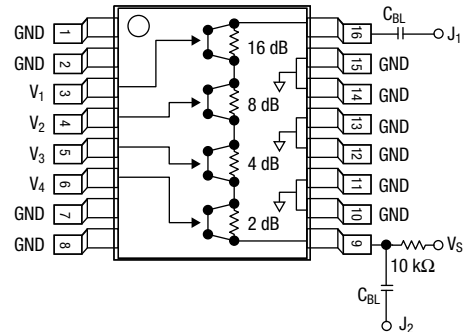

DC blocking capacitors ( $C_{BL}$ ) and biasing resistor must be supplied externally for positive voltage operation.  
 $C_{BL} = 47$  pF for operation >500 MHz.

## Electrical Specifications

**-40 °C ≤ T ≤ +85 °C, Z<sub>0</sub> = 50 Ω, V<sub>CTL</sub> = 0/5 V, unless otherwise specified.**

Parameter	Condition	Frequency	Min.	Typ.	Max.	Unit
Insertion loss		0.5–1.0 GHz		1.6	2.0	dB
		1.0–2.0 GHz		1.8	2.4	dB
Attenuation range			30			dB
Attenuation accuracy		0.5–1.0 GHz	± (0.2 + 3% of attenuation setting in dB)			dB
		1.0–2.0 GHz	± (0.3 + 5% of attenuation setting in dB)			dB
		1.0–2.0 GHz	± (0.3 + 6% of attenuation setting in dB)			dB
VSWR (Input/Output)		0.5–0.8 GHz		1.8:1	2.2:1	
		0.8–2.0 GHz		1.5:1	2.0:1	
Switching characteristics	T = 25 °C					
Rise, fall	10/90% or 90/10% RF			150		ns
On, off	50% CTL to 90/10% RF			300		ns
Video feedthru	T <sub>RISE</sub> = 1 ns, BW = 500 MHz			70		mV
Input power for 1 dB compression	V <sub>S</sub> = 3 V	0.5–2.0 GHz	15	21		dBm
	V <sub>S</sub> = 5 V	0.5–2.0 GHz	21	27		dBm
Intermodulation intercept point (IP3)	For two-tone input power 5 dBm					
	V <sub>S</sub> = 3 V	0.5–2.0 GHz	36	44		dBm
	V <sub>S</sub> = 5 V	0.5–2.0 GHz	37	45		dBm
Control voltages	V <sub>LOW</sub>		0		0.2	V
	V <sub>HIGH</sub>		3		5.0	V
Supply voltages	V <sub>CTL</sub> = 5 V		V <sub>HIGH</sub> -0.2		V <sub>HIGH</sub> +0.2	V
Control port current	V <sub>CTL</sub> = V <sub>LOW</sub>				20	μA
	V <sub>CTL</sub> = 3 V				100	μA
	V <sub>CTL</sub> = 5 V				200	μA

### Typical Performance Data

$Z_0 = 50 \Omega$ ,  $V_{CTL} = 0/5 \text{ V}$ , unless otherwise specified.

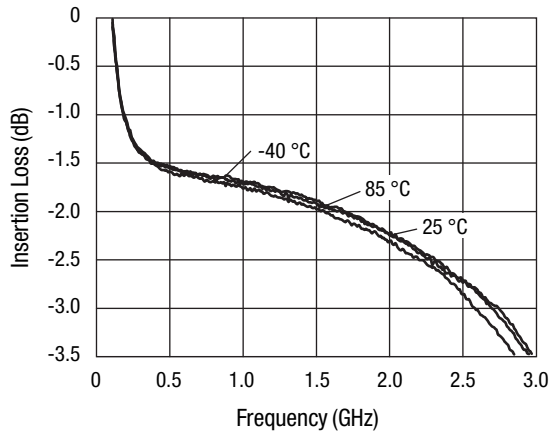

**Insertion Loss vs. Frequency**

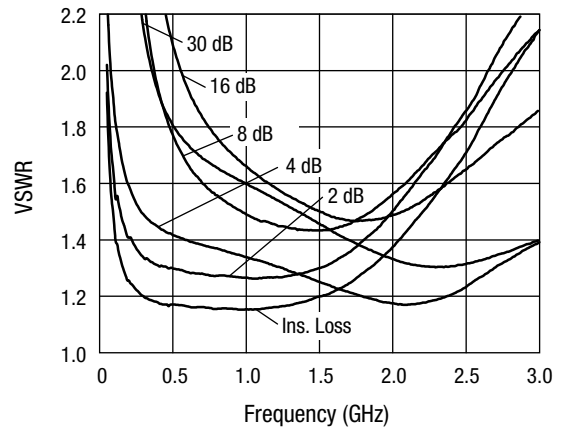

**VSWR vs. Frequency (25 °C)**

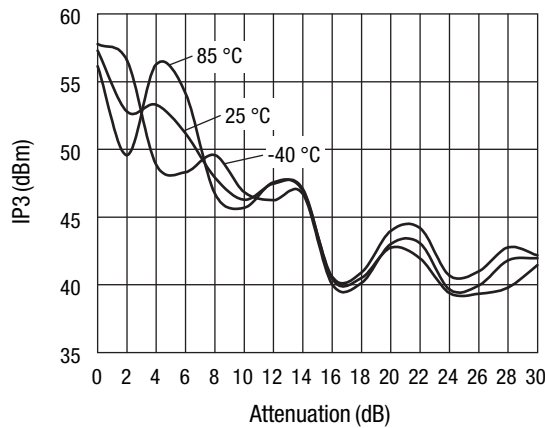

**IP3 vs. Attenuation and Temperature (500 MHz)**

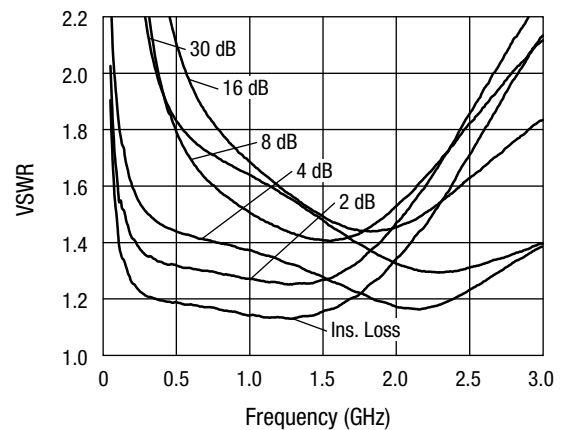

**VSWR vs. Frequency (85 °C)**

### Compression Point vs. Attenuation, Voltage, and Temperature

Attenuation State	Control Voltage (V)	Input Power @ 1 dB Compression		
		25 °C (dBm)	85 °C (dBm)	-40 °C (dBm)
Ins. Loss	5	29	28.9	29
2 dB	5	28.3	28.1	28.1
4 dB	5	35.2	34.7	35
8 dB	5	25.8	25.3	25.4
16 dB	5	21.7	21.3	21.6
30 dB	5	24.4	23.2	27.2

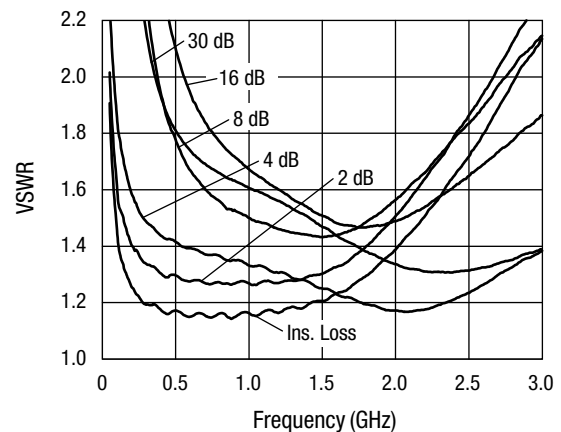

**VSWR vs. Frequency (-40 °C)**

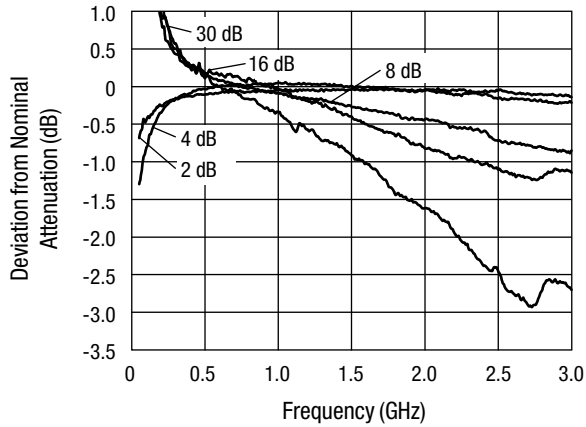

**Attenuation Accuracy vs. Frequency (25 °C)**

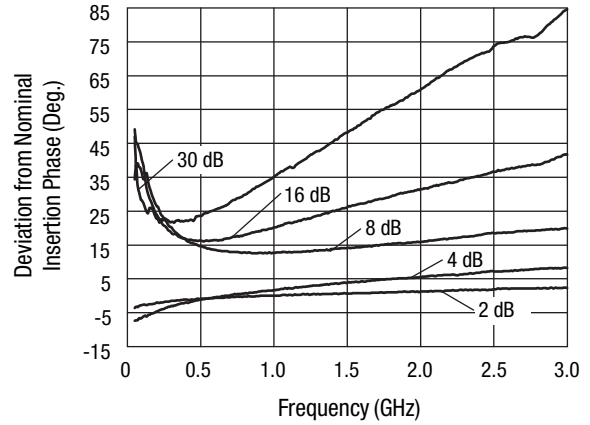

**Attenuation Phase Accuracy vs. Frequency (25 °C)**

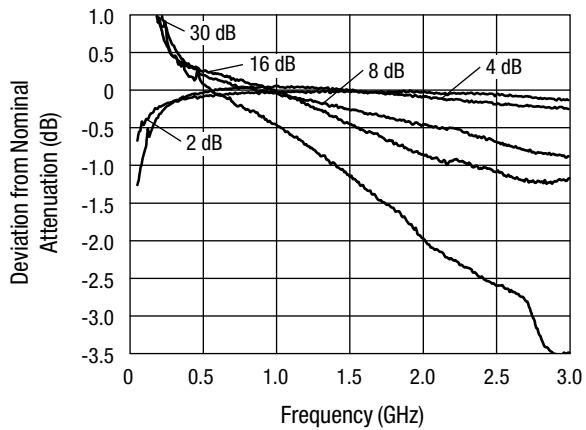

**Attenuation Accuracy vs. Frequency (85 °C)**

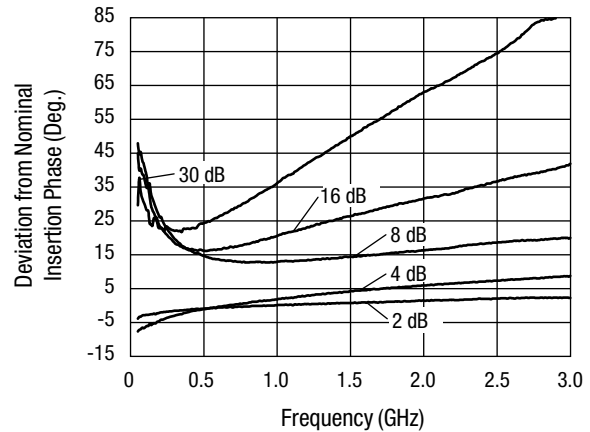

**Attenuation Phase Accuracy vs. Frequency (85 °C)**

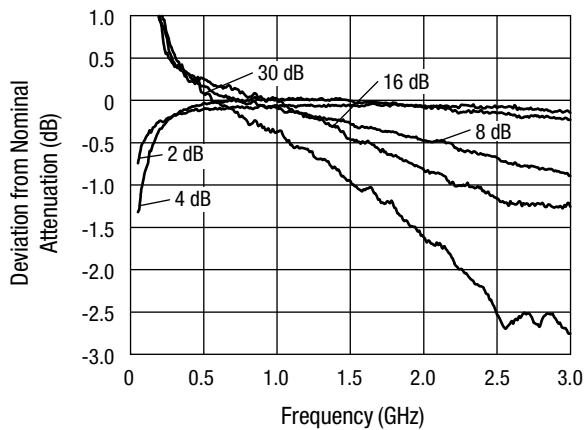

**Attenuation Accuracy vs. Frequency (-40 °C)**

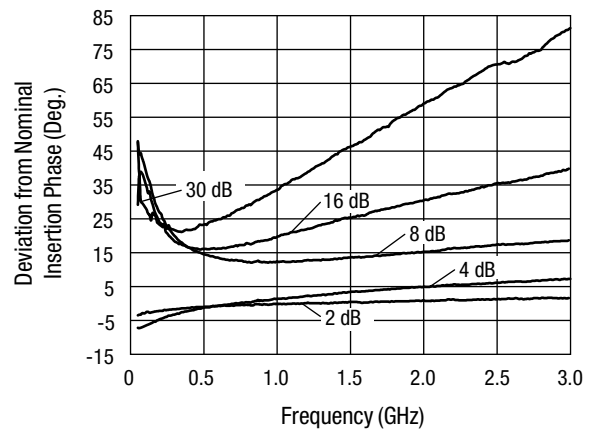

**Attenuation Phase Accuracy vs. Frequency (-40 °C)**

**Typical Performance Data (0, 3 V)**

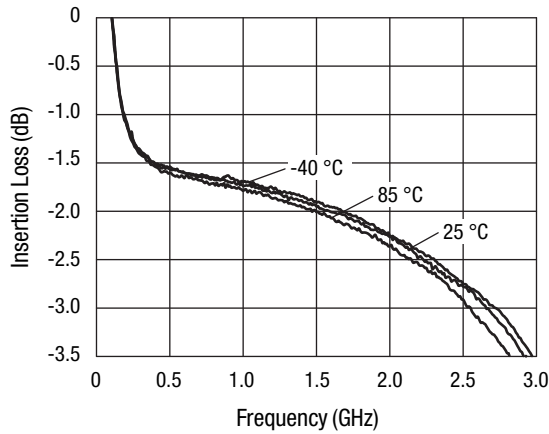

**Insertion Loss vs. Frequency**

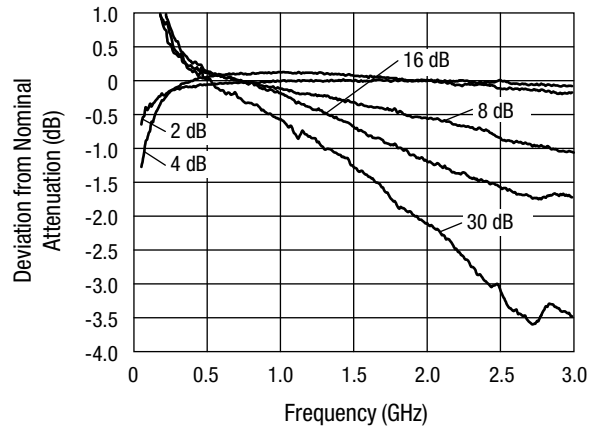

**Attenuation Accuracy vs. Frequency (25 °C)**

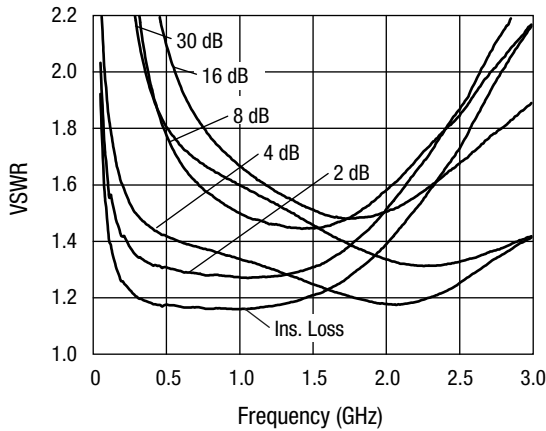

**VSWR vs. Frequency (25 °C)**

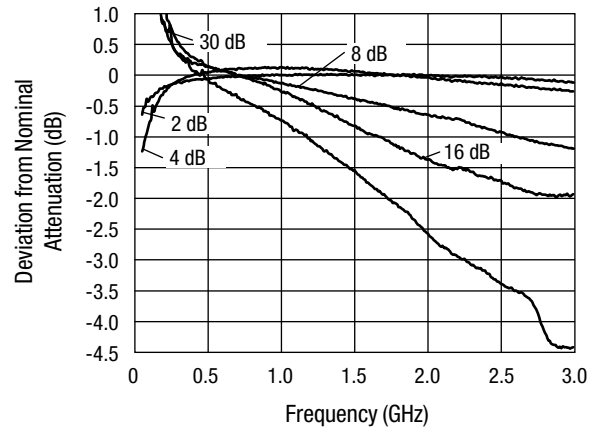

**Attenuation Accuracy vs. Frequency (85 °C)**

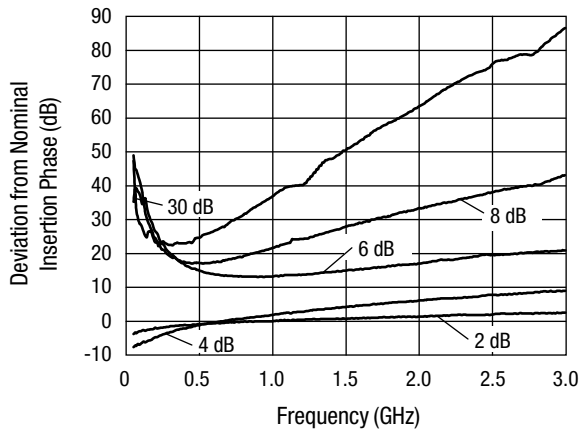

**Attenuation Phase Accuracy vs. Frequency (25 °C)**

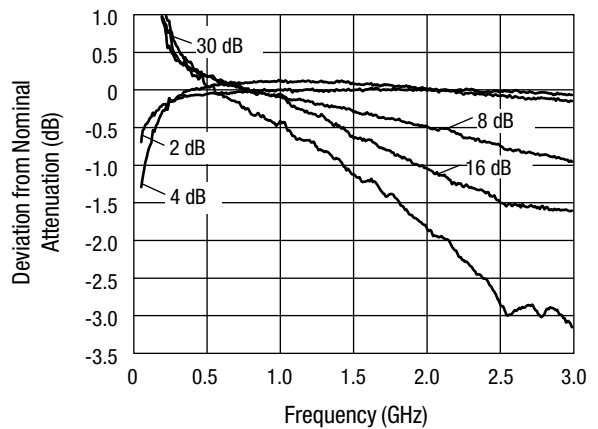

**Attenuation Accuracy vs. Frequency (-40 °C)**

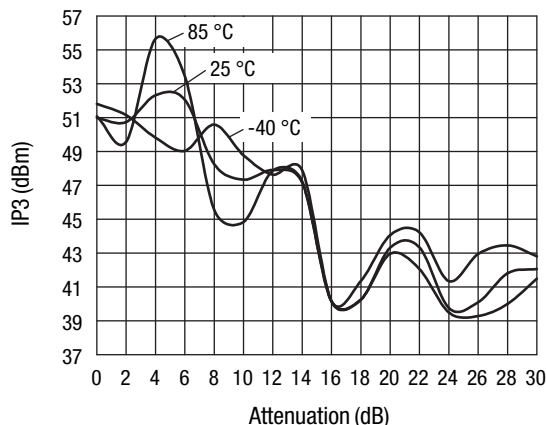

**IP3 vs. Attenuation and Temperature (500 MHz)**

**Truth Table**

V <sub>1</sub>	V <sub>2</sub>	V <sub>3</sub>	V <sub>4</sub>	Attenuation J <sub>1</sub> -J <sub>2</sub>
16 dB	8 dB	4 dB	2 dB	Reference I.L.
V <sub>HIGH</sub>	V <sub>HIGH</sub>	V <sub>HIGH</sub>	V <sub>HIGH</sub>	Reference I.L.
V <sub>HIGH</sub>	V <sub>HIGH</sub>	V <sub>HIGH</sub>	0	2 dB
V <sub>HIGH</sub>	V <sub>HIGH</sub>	0	V <sub>HIGH</sub>	4 dB
V <sub>HIGH</sub>	0	V <sub>HIGH</sub>	V <sub>HIGH</sub>	8 dB
0	V <sub>HIGH</sub>	V <sub>HIGH</sub>	V <sub>HIGH</sub>	16 dB
0	0	0	0	30 dB max. atten.

V<sub>HIGH</sub> = 3 to 5 V (V<sub>S</sub> = V<sub>HIGH</sub> ± 0.2 V).

**Recommended Solder Reflow Profiles**

Refer to the [“Recommended Solder Reflow Profile”](#) Application Note.

**Tape and Reel Information**

Refer to the [“Discrete Devices and IC Switch/Attenuators Tape and Reel Package Orientation”](#) Application Note.

**Compression Point vs. Attenuation, Voltage, and Temperature**

Attenuation State	Control Voltage (V)	Input Power @ 1 dB Compression		
		25 °C (dBm)	85 °C (dBm)	-40 °C (dBm)
Ins. Loss	3	21.7	21.6	22.6
2 dB	3	21.2	20.7	21.4
4 dB	3	34.3	31	34.3
8 dB	3	33.6	23	32.9
16 dB	3	18	17	21.4
30 dB	3	22.4	21.2	24.1

**Absolute Maximum Ratings**

Characteristic	Value
RF input power	1 W > 500 MHz 0/8 V 0.5 W @ 50 MHz 0/8 V
Supply voltage	8 V
Control voltage	-0.2 V, +8 V
Operating temperature	-40 °C to +85 °C
Storage temperature	-65 °C to +150 °C

Performance is guaranteed only under the conditions listed in the specifications table and is not guaranteed under the full range(s) described by the Absolute Maximum specifications. Exceeding any of the absolute maximum/minimum specifications may result in permanent damage to the device and will void the warranty.

**CAUTION:** Although this device is designed to be as robust as possible, ESD (Electrostatic Discharge) can damage this device. This device must be protected at all times from ESD. Static charges may easily produce potentials of several kilovolts on the human body or equipment, which can discharge without detection. Industry-standard ESD precautions must be employed at all times.

**TSSOP-16**

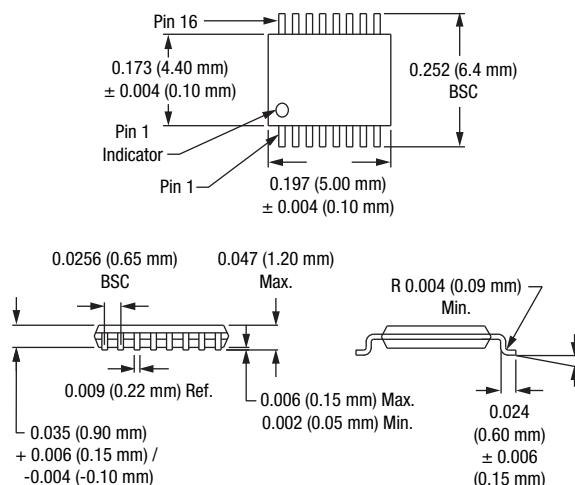

Copyright © 2002, 2003, 2004, 2005, 2006, 2007, 2008, Skyworks Solutions, Inc. All Rights Reserved.

Information in this document is provided in connection with Skyworks Solutions, Inc. ("Skyworks") products or services. These materials, including the information contained herein, are provided by Skyworks as a service to its customers and may be used for informational purposes only by the customer. Skyworks assumes no responsibility for errors or omissions in these materials or the information contained herein. Skyworks may change its documentation, products, services, specifications or product descriptions at any time, without notice. Skyworks makes no commitment to update the materials or information and shall have no responsibility whatsoever for conflicts, incompatibilities, or other difficulties arising from any future changes.

No license, whether express, implied, by estoppel or otherwise, is granted to any intellectual property rights by this document. Skyworks assumes no liability for any materials, products or information provided hereunder, including the sale, distribution, reproduction or use of Skyworks products, information or materials, except as may be provided in Skyworks Terms and Conditions of Sale.

THE MATERIALS, PRODUCTS AND INFORMATION ARE PROVIDED "AS IS" WITHOUT WARRANTY OF ANY KIND, WHETHER EXPRESS, IMPLIED, STATUTORY, OR OTHERWISE, INCLUDING FITNESS FOR A PARTICULAR PURPOSE OR USE, MERCHANTABILITY, PERFORMANCE, QUALITY OR NON-INFRINGEMENT OF ANY INTELLECTUAL PROPERTY RIGHT; ALL SUCH WARRANTIES ARE HEREBY EXPRESSLY DISCLAIMED. SKYWORKS DOES NOT WARRANT THE ACCURACY OR COMPLETENESS OF THE INFORMATION, TEXT, GRAPHICS OR OTHER ITEMS CONTAINED WITHIN THESE MATERIALS. SKYWORKS SHALL NOT BE LIABLE FOR ANY DAMAGES, INCLUDING BUT NOT LIMITED TO ANY SPECIAL, INDIRECT, INCIDENTAL, STATUTORY, OR CONSEQUENTIAL DAMAGES, INCLUDING WITHOUT LIMITATION, LOST REVENUES OR LOST PROFITS THAT MAY RESULT FROM THE USE OF THE MATERIALS OR INFORMATION, WHETHER OR NOT THE RECIPIENT OF MATERIALS HAS BEEN ADVISED OF THE POSSIBILITY OF SUCH DAMAGE.

Skyworks products are not intended for use in medical, lifesaving or life-sustaining applications, or other equipment in which the failure of the Skyworks products could lead to personal injury, death, physical or environmental damage. Skyworks customers using or selling Skyworks products for use in such applications do so at their own risk and agree to fully indemnify Skyworks for any damages resulting from such improper use or sale.

Customers are responsible for their products and applications using Skyworks products, which may deviate from published specifications as a result of design defects, errors, or operation of products outside of published parameters or design specifications. Customers should include design and operating safeguards to minimize these and other risks. Skyworks assumes no liability for applications assistance, customer product design, or damage to any equipment resulting from the use of Skyworks products outside of stated published specifications or parameters.

Skyworks, the Skyworks symbol, and "Breakthrough Simplicity" are trademarks or registered trademarks of Skyworks Solutions, Inc., in the United States and other countries. Third-party brands and names are for identification purposes only, and are the property of their respective owners. Additional information, including relevant terms and conditions, posted at [www.skyworksinc.com](http://www.skyworksinc.com), are incorporated by reference.