

High Efficiency 1x/1.5x Charge Pump

General Description

The AAT3340 is a low-noise, constant-frequency charge pump DC/DC converter that uses a dual-mode load switch (1x) and fractional (1.5x) conversion to maximize efficiency for white LED applications. The AAT3340 is capable of driving 4 white LEDs at a total of 80mA from a single 2.7V to 5.5V input. The current sinks may be operated individually or in parallel while driving higher-current LEDs. A low external parts count (two 1µF flying capacitors and two small 1µF capacitors at V_{IN} and V_{OUT}) makes the AAT3340 ideal for small battery-powered applications.

Skyworks' Simple Serial Control (S²Cwire) digital interface is used to enable, disable and set current to one of 32 levels for the LEDs.

The AAT3340 is equipped with built-in short-circuit and over-temperature protection. The soft-start circuitry prevents excessive inrush current at start-up and mode transitions. The AAT3340 family is available in Pb-free, space-saving TSOPJW and TDFN33 packages, and operates over the -40°C to +85°C ambient temperature range.

Features

- Dual-Mode (1x/1.5x) Charge Pump
- Drives up to 4-Channel Backlight LEDs
- 32-Level Programmable Backlight Current (linear, inverting)
- Single-wire S²Cwire Control
- Built-in Thermal Protection
- Automatic Soft Start
- -40°C to +85°C Temperature Range
- TSOPJW-12 and TDFN33-12 Packages

Applications

- Cellular and Smart Phones
- Digital Still and Video Cameras
- PDAs
- Portable Devices
- Portable Media Players
- Other White LED Backlighting

Typical Application

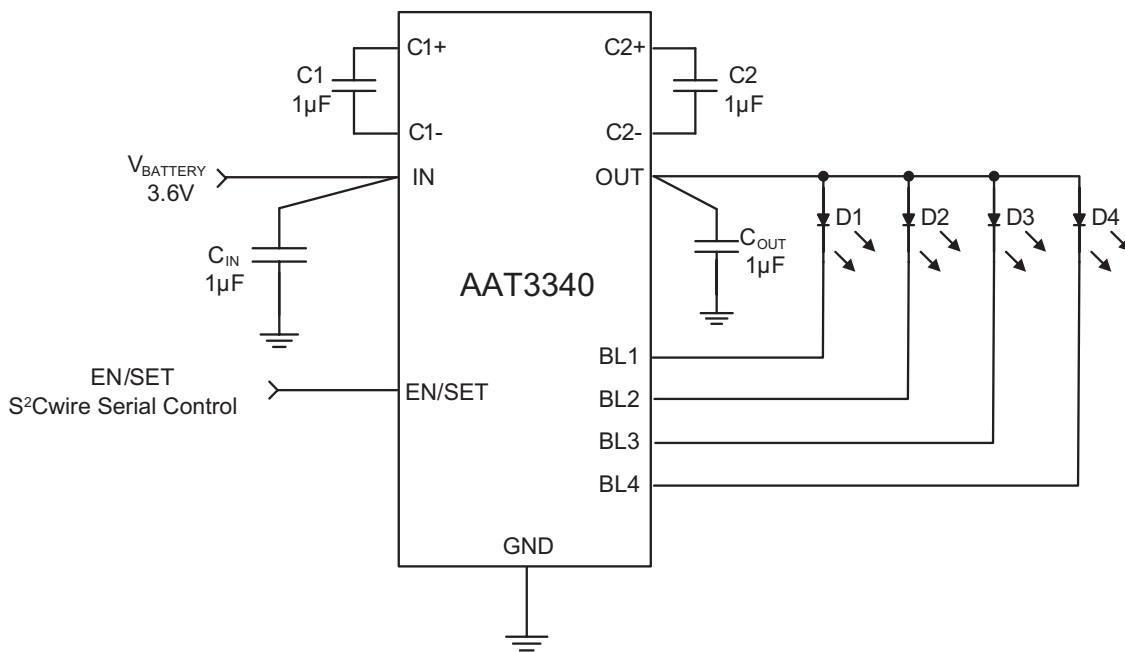

AAT3340**High Efficiency 1x/1.5x Charge Pump****Pin Description**

Pin Number		Name	Function
TDFN33-12	TSOPJW-12		
1	12	C1+	Flying capacitor 1 positive terminal. Connect a 1 μ F ceramic capacitor between C1+ and C1-.
2	11	OUT	Charge pump output to drive load circuit. Requires a 1 μ F or larger ceramic capacitor connected between this pin and ground.
3	10	IN	Input power supply. Requires a 1 μ F or larger ceramic capacitor connected between this pin and ground.
4	9	C2+	Flying capacitor 2 positive terminal. Connect a 1 μ F ceramic capacitor between C2+ and C2-.
5	8	EN/SET	AS ² Cwire serial interface control pin.
6	7	BL1	Current sink input #1.
7	6	BL2	Current sink input #2.
8	5	BL3	Current sink input #3.
9	4	BL4	Current sink input #4.
10	3	C1-	Flying capacitor 1 negative terminal.
11	2	GND	Ground pin
12	1	C2-	Flying capacitor 2 negative terminal.
EP	n/a		Exposed paddle (bottom). Connect to GND directly beneath package.

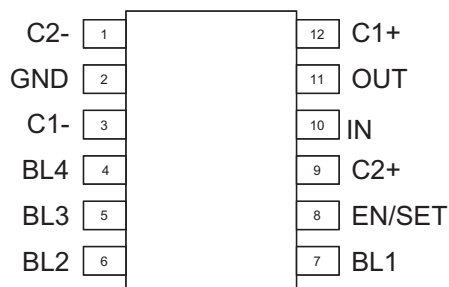
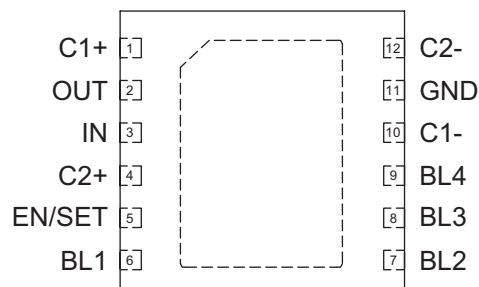
Pin Configuration**TSOPJW-12
(Top View)****TDFN33-12
(Top View)**

AAT3340*High Efficiency 1x/1.5x Charge Pump***Absolute Maximum Ratings**

$T_A = 25^\circ\text{C}$, unless otherwise noted.

Symbol	Description	Value	Units
V_{IN}	Input Voltage	-0.3 to 6	V
V_{OUT}	Charge Pump Output	-0.3 to 6	V
$V_{EN/SET}$	EN/SET to GND Voltage	-0.3 to 6	V
$V_{EN/SET(MAX)}$	Maximum EN/SET Voltage	$V_{IN} + 0.3$	V
I_{OUT}	Maximum DC Output Current (sum of IOOUT and D currents)	120	mA
T_J	Operating Junction Temperature Range	-40 to 150	$^\circ\text{C}$

Thermal Information¹

Symbol	Description	Value	Units
θ_{JA}	Maximum Thermal Resistance ²	TSOPJW-12	160
		TDFN33-12	50
P_D	Maximum Power Dissipation ²	TSOPJW-12	625
		TDFN33-12	2
T_J	Operating Junction Temperature Range	-40 to 150	$^\circ\text{C}$

1. Mounted on an FR4 board.
2. Derate 6.25mW/ $^\circ\text{C}$ above 25 $^\circ\text{C}$.

High Efficiency 1x/1.5x Charge Pump

Electrical Characteristics

$V_{IN} = 3.6V$; $C_{IN} = C_{OUT} = 1\mu F$; $C1 = C2 = 1\mu F$; $T_A = -40^{\circ}C$ to $85^{\circ}C$ unless otherwise noted. Typical values are $T_A = 25^{\circ}C$.

Symbol	Parameter	Conditions	Min	Typ	Max	Units
Input Power Supply						
V_{IN}	Input Voltage Range		2.7		5.5	V
I_Q	Operating Current	EN/SET = IN; 1x Mode, $V_{D1} = V_{D2} = V_{D3}$; $V_{D4} = 1V$		1.8	7.0	mA
		EN/SET = IN; 1.5x Mode, $I_{D1} = I_{D2} = I_{D3}$; $I_{D4} = \text{Open}$		4.8	7.2	
I_{SHDN}	V_{IN} Shutdown Current	EN/SET = GND			1	μA
V_{IN_TH}	Charge Pump Mode Hysteresis	1x to 1.5x Transition at Any I_{DX} ; $I_{D1} = I_{D2} = I_{D3}$; $I_{D4} = 20mA$		0.15		V
T_{SD}	Thermal Shutdown Threshold			140		$^{\circ}C$
$T_{SD(HYS)}$	Thermal Shutdown Hysteresis			15		$^{\circ}C$
LED Current Sink Outputs						
$I_{(D-ACC)}$	LED Current Accuracy	EN/SET = DATA1	18	20	22	mA
		EN/SET = DATA31	0.52	0.64	0.78	
$I_{(D-Match)}$	LED Current Matching ¹	$I_{MLED} = 20mA$		± 3		%
V_{D_TH}	Hysteresis for Mode Change	$I_{MLED} = 20mA$ at 1.5x to 1x Mode		0.15	0.25	V
I_{DMAX}	Charge Pump Maximum Output Current			120		mA
f_{OSC}	Clock Frequency			1		MHz
V_{BL_TH}	Charge Pump Mode Transition Threshold			0.15		V
t_{SS}	Charge Pump Start Up Time			150		μs
EN/SET and S²Cwire Control						
V_{ENH}	EN/SET Input High Threshold Voltage		1.4			V
V_{ENL}	EN/SET Input Low Threshold Voltage				0.4	V
$t_{EN/SET(HI_MIN)}$	EN/SET Minimum High Time			50		ns
$t_{EN/SET(HI_MAX)}$	EN/SET Maximum High Time				75	μs
$t_{EN/SET(LOW)}$	EN/SET Input Low Time		0.3		75	μs
$t_{EN/SET(OFF)}$	EN/SET Input OFF Timeout				500	μs
$t_{EN/SET(LAT)}$	EN/SET Input Latch Timeout ²				500	μs

1. LED current match is defined as $100 (I_{DX} - I_{AVG})/I_{AVG}$.

2. If the part has been shut down, then the latch time would be 500 μs longer for soft start of charge pump.

AAT3340

High Efficiency 1x/1.5x Charge Pump

Typical Characteristics

$V_{IN} = 3.6V$, $C_{IN} = C_{OUT} = C1 = C2 = 1\mu F$; $T_A = 25^\circ C$, unless otherwise noted.

No Load Operating Current (1.5x Mode) vs. Input Voltage

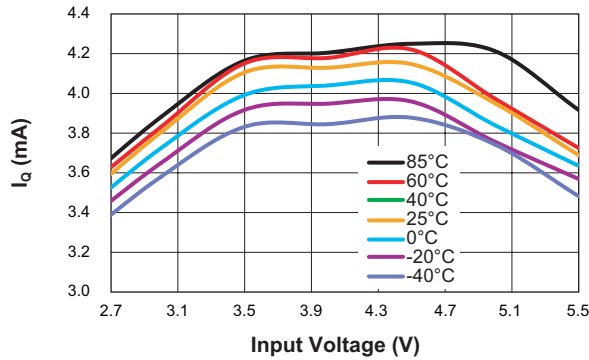

No Load Operating Current (1x Mode) vs. Input Voltage

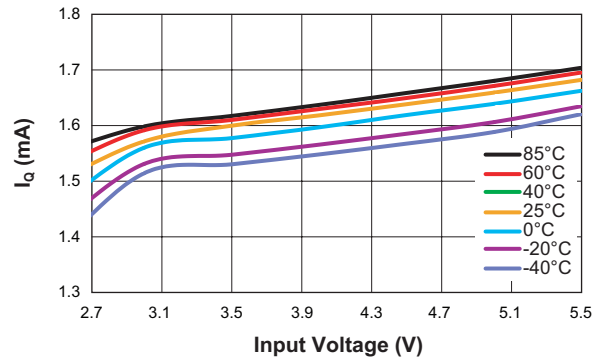

Shutdown Current vs. Temperature

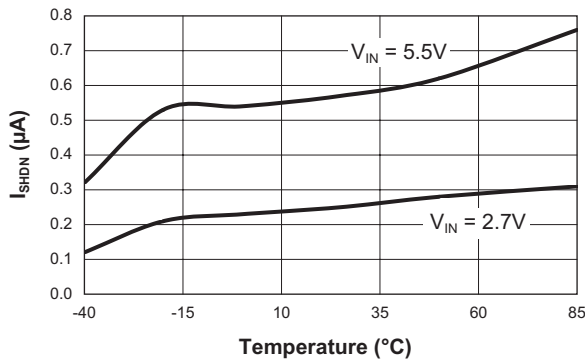

1.5X Mode Output Voltage vs. Output Current

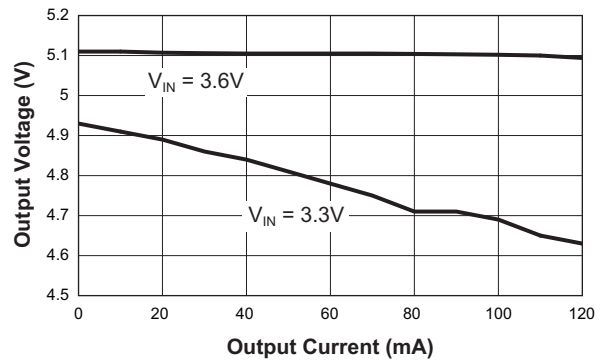

Efficiency vs. Input Voltage (Code 26, ILED = 3.8mA)

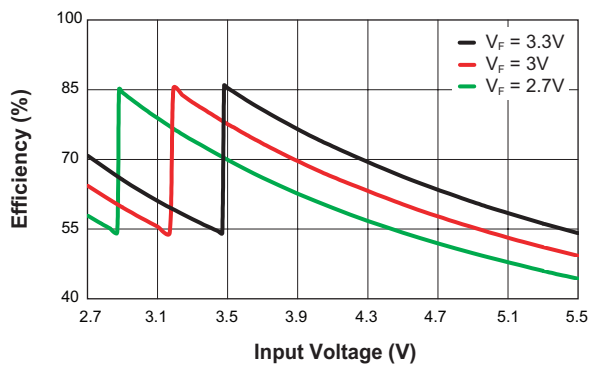

Efficiency vs. Input Voltage (Code 1, BL = 20mA)

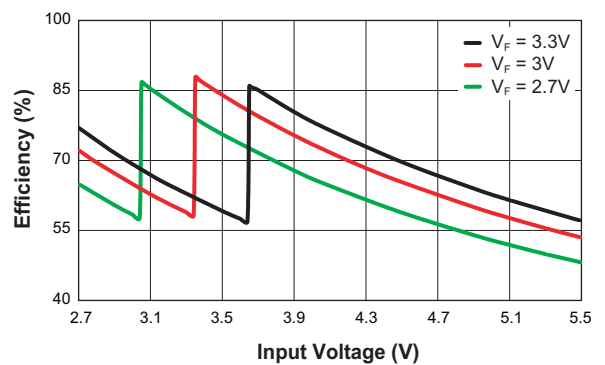

AAT3340

High Efficiency 1x/1.5x Charge Pump

Typical Characteristics

$V_{IN} = 3.6V$, $C_{IN} = C_{OUT} = C1 = C2 = 1\mu F$; $T_A = 25^\circ C$, unless otherwise noted.

EN/SET Input Latch Timeout vs. Input Voltage

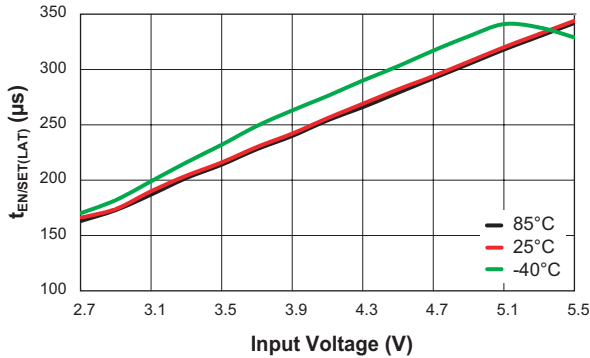

EN/SET Input OFF Timeout vs. Input Voltage

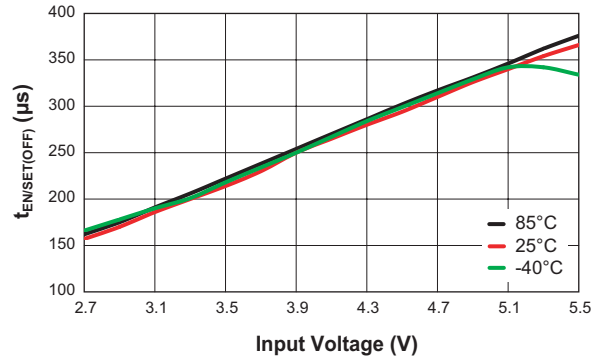

Output Current Matching Over Temperature

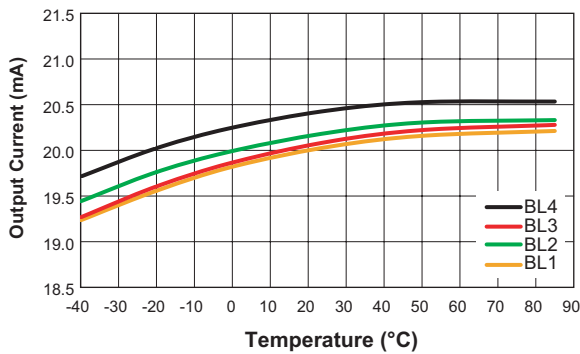

EN Input High Threshold Voltage vs. Input Voltage

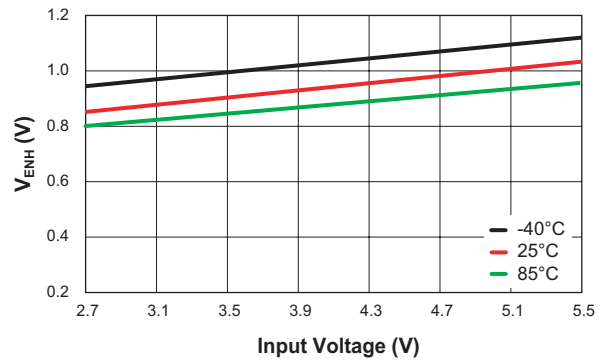

EN Input Low Threshold Voltage vs. Input Voltage

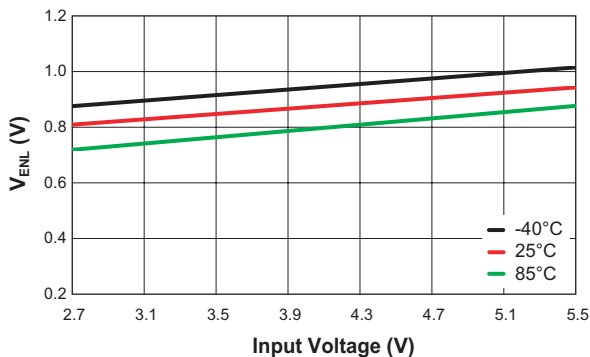

1x Mode Turn-On Waveform
($V_{IN} = 3.6V$; Load = 80mA)

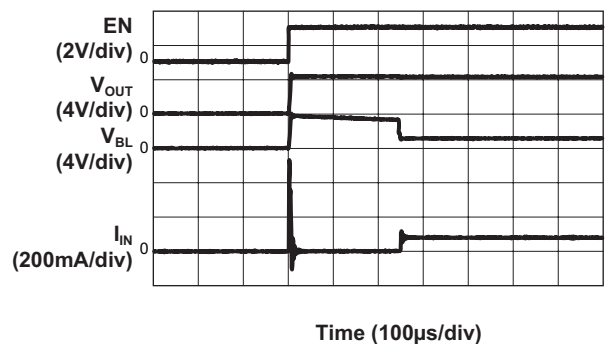

AAT3340

High Efficiency 1x/1.5x Charge Pump

Typical Characteristics

$V_{IN} = 3.6V$, $C_{IN} = C_{OUT} = C1 = C2 = 1\mu F$; $T_A = 25^\circ C$, unless otherwise noted.

1.5x Mode Turn-On Waveform
($V_{IN} = 3.3V$; 80mA Load)

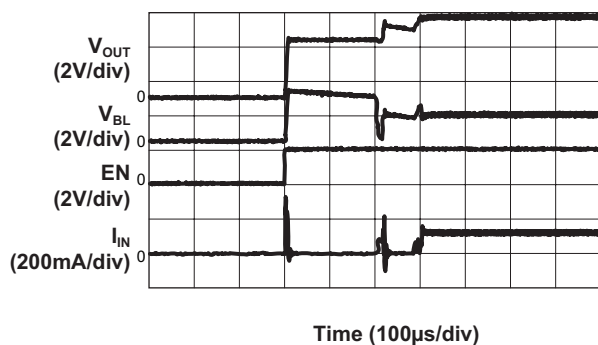

1.5x Mode Load Characteristics
($V_{IN} = 3.3V$; 80mA Load)

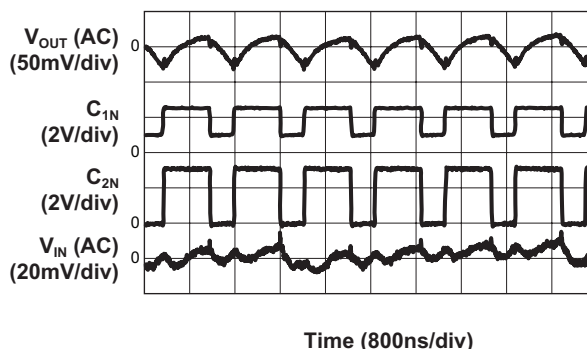

1.5x Mode Turn-Off
($V_{IN} = 3.3V$; Load = 80mA)

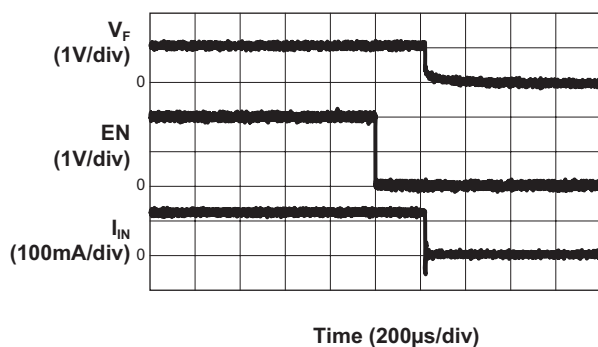

AAT3340

High Efficiency 1x/1.5x Charge Pump

Functional Block Diagram

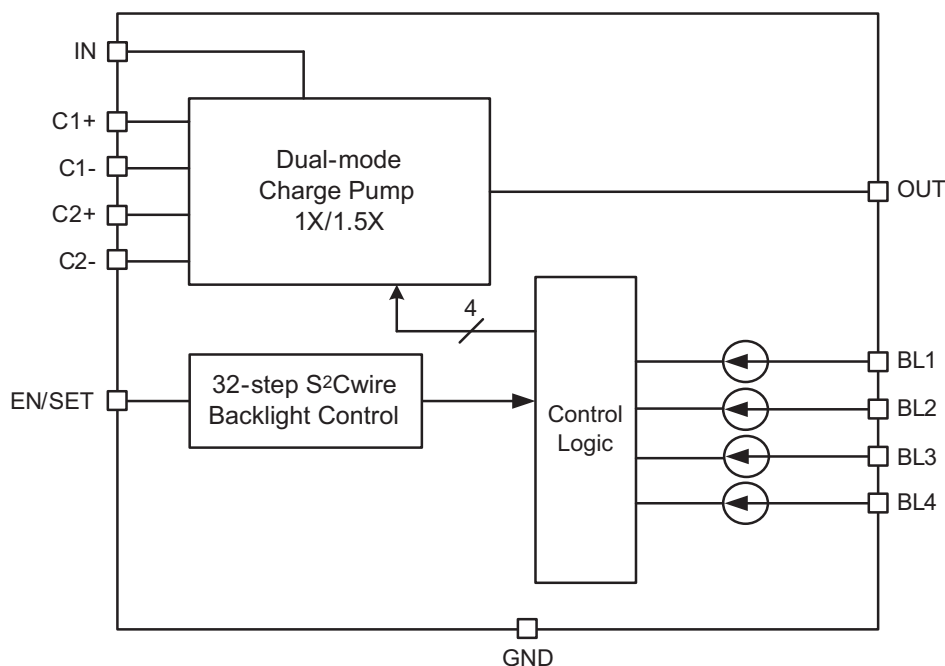

Functional Description

The AAT3340 is a high efficiency charge pump white LED driver for portable applications. It can drive 4 white LEDs.

The AAT3340 is a fractional charge pump and can multiply the input voltage by 1 or 1.5 times. The charge pump switches at a fixed frequency of 1MHz. The internal-mode-selection-circuit automatically switches the mode between 1x and 1.5x mode base on the input voltage, output voltage and load current. This mode switching maximizes the efficiency throughout the entire load range.

When the input voltage is high enough, the AAT3340 operates in 1x mode to provide maximum efficiency. If the input voltage is too low to supply programmed LED current, typically when the battery discharges and the voltage decays, a 1.5x mode is automatically enabled. When the battery is connected to a charger and the input voltage become high enough again, the device will switch back to 1x mode.

The current sink magnitude is controlled by the EN/SET serial data S²Cwire interface. The interface records rising edges of the EN/SET pin and decodes them into 32 individual current level settings.

Application Information

Current Level Settings

LED current level is set via Skyworks' Simple Serial Control (S²Cwire) interface in a linear scale where each code is 0.6mA smaller than the previous code, as shown in Figure 1. In this manner, the LED current decreases linearly with each increasing code.

LED Current vs. S²C Data
($V_F = 3.0V @ 20mA$)

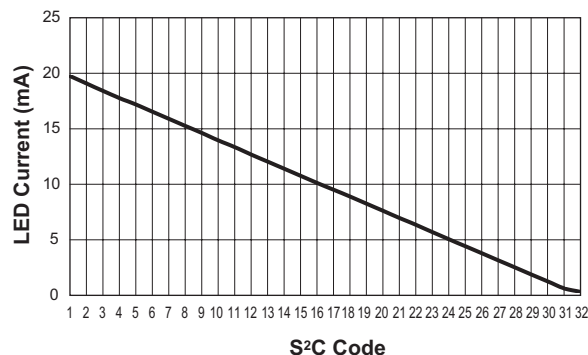

Figure 1: LED Current Level vs. Simple Serial Control (S²Cwire).

High Efficiency 1x/1.5x Charge Pump

S ² Cwire Data	LED Current (mA)	S ² Cwire Data	LED Current (mA)
1	20.0	17	9.7
2	19.4	18	9.0
3	18.7	19	8.4
4	18.1	20	7.7
5	17.4	21	7.1
6	16.8	22	6.5
7	16.1	23	5.8
8	15.5	24	5.2
9	14.8	25	4.5
10	14.2	26	3.9
11	13.6	27	3.2
12	12.9	28	2.6
13	12.3	29	1.9
14	11.6	30	1.3
15	11.0	31	0.6
16	10.3	32	0.3

Table 2: S²C Data vs LED Current.**EN/SET Serial Interface**

The LED current magnitude is controlled by the EN/SET pin using the S²Cwire interface. The interface records rising edges of the EN/SET pin and decodes them into 32 individual current level settings. Code 1 is full scale, and Code 32 is 0.3mA. The modulo 32 interface wraps states back to state 1 after the 32nd clock. The counter can be clocked at speeds up to 1MHz, so intermediate states are not visible. The first rising edge of EN/SET enables the IC and initially sets the output LED current to full scale, the lowest setting equal to 0.3mA. Once the final clock cycle is input for the desired brightness level, the EN/SET pin should be held high to maintain the device out-

put current at the programmed level. The device is disabled 500μs after the EN/SET pin enters a logic low state. The EN/SET timing is designed to accommodate a wide range of data rates. After the first rising edge of EN/SET, the charge pump is enabled and reaches full capacity after the soft-start time (T_{SS}). Exact counts of clock pulses for the desired current level should be entered on the EN/SET pin with a single burst of clocks. The counter refreshes each time a new clock input to the EN/SET pin is detected. A constant current is sunk as long as EN/SET remains in a logic high state. The current sink pins are switched off after EN/SET has remained low state for at least the t_{OFF} timeout period (see Figure 1).

LED Selection

The AAT3340 is designed to drive white LEDs with forward voltages up to 4.8V. Since BL1 through BL4 output current sinks are matched with negligible voltage dependence; the LED brightness will be matched regardless of their forward voltage matching.

Device Switching Noise Performance

The AAT3340 operates at a fixed frequency of 1MHz to control noise and limit harmonics that can interfere with the RF operation of cellular telephone handsets or other communication devices. Back-injected noise appearing on the input pin of the charge pump is 20mV peak-to-peak, typically ten times less than inductor-based DC/DC boost converter white LED backlight solutions. The AAT3340 soft-start feature prevents noise transient effects associated with inrush currents during startup of the charge pump circuit.

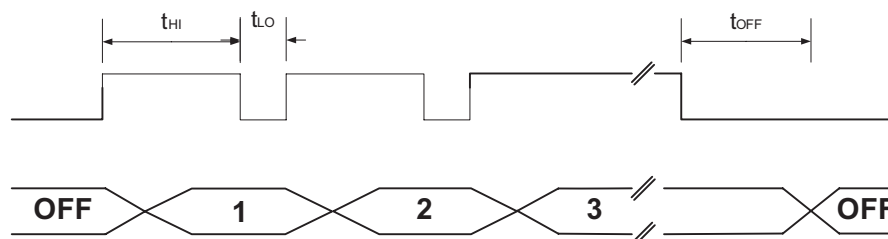
**Figure 2: EN/SET Timing Diagram.**

High Efficiency 1x/1.5x Charge Pump**Power Efficiency and Device Evaluation**

The charge pump efficiency discussion in the following sections accounts only for efficiency of the charge pump section itself. Due to the unique circuit architecture and design of the AAT3340, it is very difficult to measure efficiency in terms of a percent value comparing input power over output power. Since the AAT3340 outputs are pure constant current sinks and typically drive individual loads, it is difficult to measure the output voltage for a given output to derive an overall output power measurement.

For any given application, white LED forward voltage levels can differ, yet the output drive current will be maintained as a constant. This makes quantifying output power a difficult task when taken in the context of comparing to other white LED driver circuit topologies. A better way to quantify total device efficiency is to observe the total input power to the device for a given LED current drive level. The best white LED driver for a given application should be based on trade-offs of size, external components count, reliability, operating range, and total energy usage...*not just % efficiency*. The AAT3340 efficiency may be quantified under specific conditions and is dependent upon the input voltage and voltage on BL outputs BL1 through BL4 for a given constant current setting.

At any given current setting, if V_{IN} is sufficiently high to avoid drop-out for all the BL pin in 1x mode, the device stays in 1x mode. If in 1x mode, V_{in} is less than the voltage required on any of the 4 current sink channels to avoid drop-out, the device will operate in 1.5x charge pump mode. Each of these two modes will yield different efficiency values.

The AAT3340 contains a fractional charge pump which will boost the input supply voltage when V_{IN} is less than the voltage required on the constant current sink pins. The ideal efficiency (η) can be defined as:

$$\eta = \frac{P_{LED}}{P_{IN}} = \frac{V_F \cdot I_{LED}}{V_{IN} \cdot I_{IN}}$$

V_F is the LED forward voltage.

In 1x mode, $I_{IN} = I_{LED} + I_Q$.

Ignore the quiescent current, it's much smaller than I_{LED} .

$$\eta = \frac{V_F \cdot I_{LED}}{V_{IN} \cdot I_{IN}}$$

In 1.5X mode, $I_{IN} = 1.5 \cdot I_{LED} + I_Q$.

Ignore the quiescent current, it's much smaller than I_{LED} .

$$\eta = \frac{V_F \cdot I_{LED}}{V_{IN} \cdot 1.5 \cdot I_{IN}}$$

Please also refer to the Typical Characteristics section of this document for measured plots of efficiency versus input voltage and output load current for the given charge pump output voltage options.

Capacitor Selection

Careful selection of the four external capacitors C_{IN} , C_1 , C_2 , and C_{OUT} is important because they will affect turn-on time, output ripple, and transient performance. Optimum performance will be obtained when low equivalent series resistance (ESR) ceramic capacitors are used. In general, low ESR may be defined as less than 100m Ω . A value of 1 μ F for all four capacitors is a good starting point when choosing capacitors. If the LED current sinks are only programmed for low current levels, then the capacitor size may be decreased.

Test Current/Channel Disable

Each current sink channel is equipped with a test current function. While it has been enabled, the AAT3340 automatically detects the presence of LEDs all the time. Unused channels that are tied to OUT or LED loads that have failed will be automatically disabled.

Capacitor Characteristics

Ceramic composition capacitors are highly recommended over all other types of capacitors for use with the AAT3340. Ceramic capacitors offer many advantages over their tantalum and aluminum electrolytic counterparts. A ceramic capacitor has very low ESR, is lowest cost, has a smaller PCB footprint, and is non-polarized. Low ESR ceramic capacitors help to maximize charge pump transient response. Since ceramic capacitors are non-polarized, they are not prone to incorrect connection damage.

AAT3340

High Efficiency 1x/1.5x Charge Pump

Equivalent Series Resistance

ESR is an important characteristic to consider when selecting a capacitor. ESR is a resistance internal to a capacitor that is caused by the leads, internal connections, size or area, material composition, and ambient temperature. Capacitor ESR is typically measured in milliohms for ceramic capacitors and can range to more than several ohms for tantalum or aluminum electrolytic capacitors.

Ceramic Capacitor Materials

Ceramic capacitors less than 0.1 μ F are typically made from NPO or C0G materials. NPO and C0G materials have tight tolerance and are stable over temperature. Capacitors with large values are typically composed of X7R, X5R, Z5U, or Y5V dielectric materials.

Large ceramic capacitors, greater than 2.2 μ F, are often available in low-cost Y5V and Z5U dielectrics, but capacitors greater than 1 μ F are usually not required for AAT3340 applications.

Capacitor area is another contributor to ESR. Capacitors that are physically large will have a lower ESR when compared to an equivalent material smaller capacitor. These larger devices can improve circuit transient response when compared to an equal value capacitor in a smaller package size.

Thermal Protection

The AAT3340 has a built-in thermal protection circuit that will shut down the charge pump if the die temperature rises above the thermal limit, as is generally the case during short-circuit event of the V_{OUT} pin.

Evaluation Board Layout

When designing a PCB for the AAT3340, the key requirements are:

1. Place the two flying capacitors, C1 and C2, as close to the chip as possible, otherwise the 1.5X mode performance will be compromised.
2. Place the input and output decoupling capacitors as close to the chip as possible to reduce switching noise and output ripple.

AAT3340

High Efficiency 1x/1.5x Charge Pump

Ordering Information

Interface	Current Control	Package	Marking	Part Number(Tape & Reel)
S ² Cwire	32-step	TSOPJW-12	2GXY	AAT3340ITP-1-T1
S ² Cwire	32-step	TDFN33-12	2HXY	AAT3340IWP-1-T1



Skyworks Green™ products are compliant with all applicable legislation and are halogen-free.

For additional information, refer to Skyworks

Definition of Green™, document number

SQ04-0074.

Package Information

TSOPJW-12

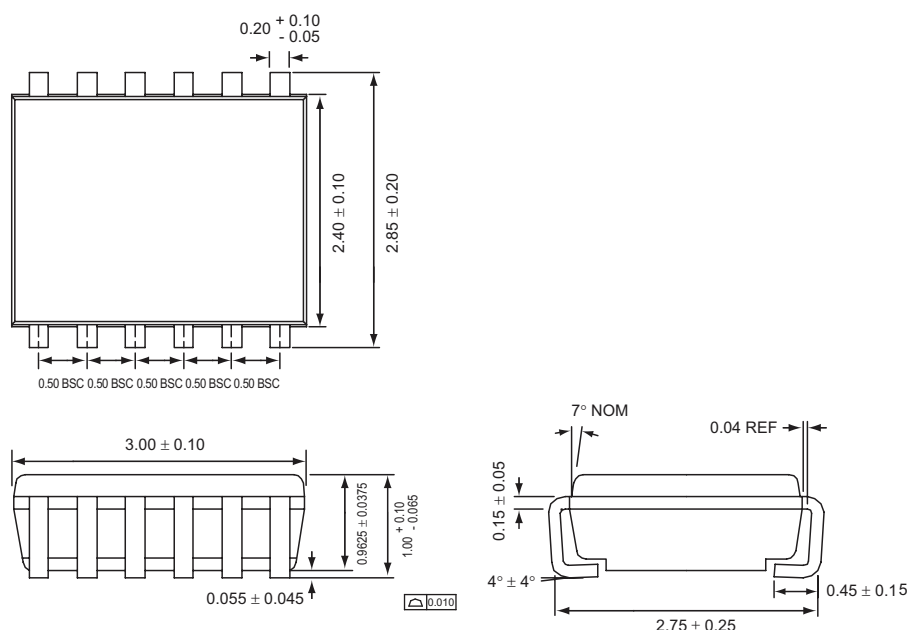

All dimensions in millimeters.

1. XYY = assembly and date code.
2. Sample stock is generally held on part numbers listed in **BOLD**.

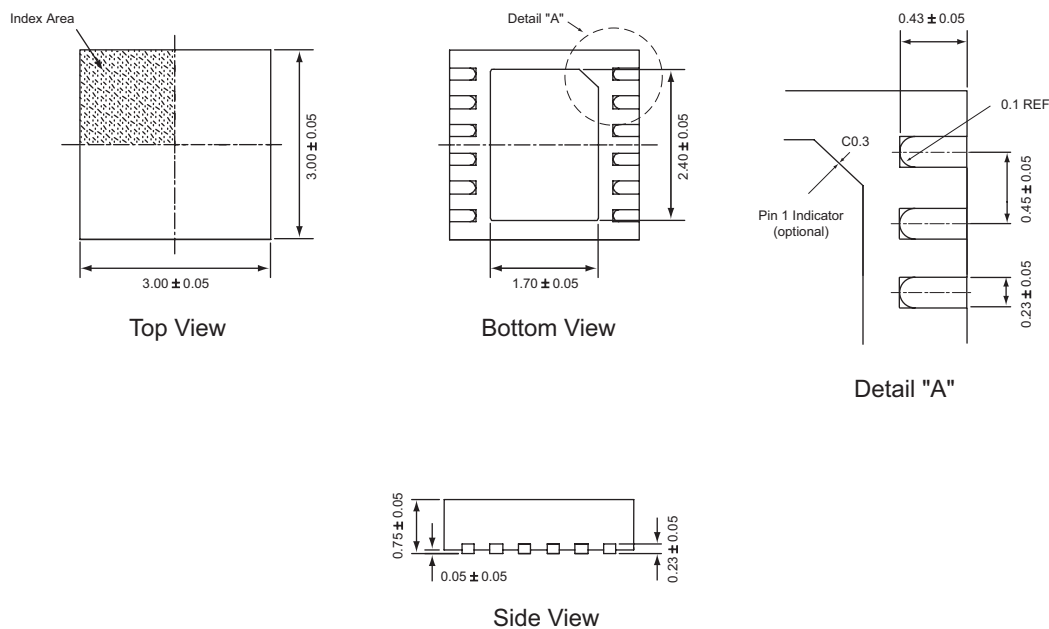
High Efficiency 1x/1.5x Charge Pump**TDFN33-12**

All dimensions in millimeters.

1. The leadless package family, which includes QFN, TQFN, DFN, TDFN and STDFN, has exposed copper (unplated) at the end of the lead terminals due to the manufacturing process. A solder fillet at the exposed copper edge cannot be guaranteed and is not required to ensure a proper bottom solder connection.

Copyright © 2012 Skyworks Solutions, Inc. All Rights Reserved.

Information in this document is provided in connection with Skyworks Solutions, Inc. ("Skyworks") products or services. These materials, including the information contained herein, are provided by Skyworks as a service to its customers and may be used for informational purposes only by the customer. Skyworks assumes no responsibility for errors or omissions in these materials or the information contained herein. Skyworks may change its documentation, products, services, specifications or product descriptions at any time, without notice. Skyworks makes no commitment to update the materials or information and shall have no responsibility whatsoever for conflicts, incompatibilities, or other difficulties arising from any future changes.

No license, whether express, implied, by estoppel or otherwise, is granted to any intellectual property rights by this document. Skyworks assumes no liability for any materials, products or information provided hereunder, including the sale, distribution, reproduction or use of Skyworks products, information or materials, except as may be provided in Skyworks Terms and Conditions of Sale.

THE MATERIALS, PRODUCTS AND INFORMATION ARE PROVIDED "AS IS" WITHOUT WARRANTY OF ANY KIND, WHETHER EXPRESS, IMPLIED, STATUTORY, OR OTHERWISE, INCLUDING FITNESS FOR A PARTICULAR PURPOSE OR USE, MERCHANTABILITY, PERFORMANCE, QUALITY OR NON-INFRINGEMENT OF ANY INTELLECTUAL PROPERTY RIGHT; ALL SUCH WARRANTIES ARE HEREBY EXPRESSLY DISCLAIMED. SKYWORKS DOES NOT WARRANT THE ACCURACY OR COMPLETENESS OF THE INFORMATION, TEXT, GRAPHICS OR OTHER ITEMS CONTAINED WITHIN THESE MATERIALS. SKYWORKS SHALL NOT BE LIABLE FOR ANY DAMAGES, INCLUDING BUT NOT LIMITED TO ANY SPECIAL, INDIRECT, INCIDENTAL, STATUTORY, OR CONSEQUENTIAL DAMAGES, INCLUDING WITHOUT LIMITATION, LOST REVENUES OR LOST PROFITS THAT MAY RESULT FROM THE USE OF THE MATERIALS OR INFORMATION, WHETHER OR NOT THE RECIPIENT OF MATERIALS HAS BEEN ADVISED OF THE POSSIBILITY OF SUCH DAMAGE.

Skyworks products are not intended for use in medical, lifesaving or life-sustaining applications, or other equipment in which the failure of the Skyworks products could lead to personal injury, death, physical or environmental damage. Skyworks customers using or selling Skyworks products for use in such applications do so at their own risk and agree to fully indemnify Skyworks for any damages resulting from such improper use or sale.

Customers are responsible for their products and applications using Skyworks products, which may deviate from published specifications as a result of design defects, errors, or operation of products outside of published parameters or design specifications. Customers should include design and operating safeguards to minimize these and other risks. Skyworks assumes no liability for applications assistance, customer product design, or damage to any equipment resulting from the use of Skyworks products outside of stated published specifications or parameters.

Skyworks, the Skyworks symbol, and "Breakthrough Simplicity" are trademarks or registered trademarks of Skyworks Solutions, Inc., in the United States and other countries. Third-party brands and names are for identification purposes only, and are the property of their respective owners. Additional information, including relevant terms and conditions, posted at www.skyworksinc.com, are incorporated by reference.