

**PCMCIA Current Limit Interface and Capacitor Charger**

**General Description**

The AAT4620 SmartSwitch is a current limited P-channel MOSFET power switch designed for high-side load-switching applications in PCMCIA GSM/GPRS/3G modem cards. Used in conjunction with a super capacitor, the AAT4620 will ensure that the power ratings of the PCMCIA host are not exceeded at any time. Featuring two independent, programmable current limits and a power loop, the AAT4620 can ensure that the super capacitor can be charged without exceeding PCMCIA specifications. The current limit is set by two external resistors allowing a  $\pm 10\%$  current limit accuracy over the normal operating temperature range. The switch can be controlled from either of the two enable inputs and in the off condition will block currents in both directions. The AAT4620 also incorporates a System READY function which can advise the system that the super capacitor is fully charged and ready for use. Adjustable hysteresis is provided with the addition of an external resistor. The quiescent supply current is typically a low  $40\mu\text{A}$ . In shutdown mode, the supply current decreases to less than  $1\mu\text{A}$ .

The AAT4620 is available in a thermally enhanced, Pb-free, 12-pin TSOPJW package and is specified over the  $-40^{\circ}\text{C}$  to  $85^{\circ}\text{C}$  temperature range.

**Features**

- $V_{\text{IN}}$  Range: 3.0V to 5.5V
- Dual Independent Current Limits
  - 100mA to 1200mA
  - $\pm 10\%$  Current Accuracy
  - $20^{\circ}\text{C}$  Temperature Band
- Reverse Current Blocking Protection
- Power Loop
- Low Quiescent Current
  - $40\mu\text{A}$  Typical
  - $1.0\mu\text{A}$  Max with Switch Off
- $65\text{m}\Omega$  Typical  $R_{\text{DS(ON)}}$  at 3V
- Only 1.4V Needed for Enable Control Pin
- System READY Output with Externally Programmable Hysteresis
- Under-Voltage Lockout
- Temperature Range:  $-40^{\circ}\text{C}$  to  $85^{\circ}\text{C}$
- 12-Pin TSOPJW Package

**Applications**

- CF Card Port Power Protection
- Express Card GSM/GPRS/3G Modems
- Hot Swap Supplies
- PCMCIA Card GSM/GPRS/3G Modems
- Personal Communication Devices

**Typical Application**

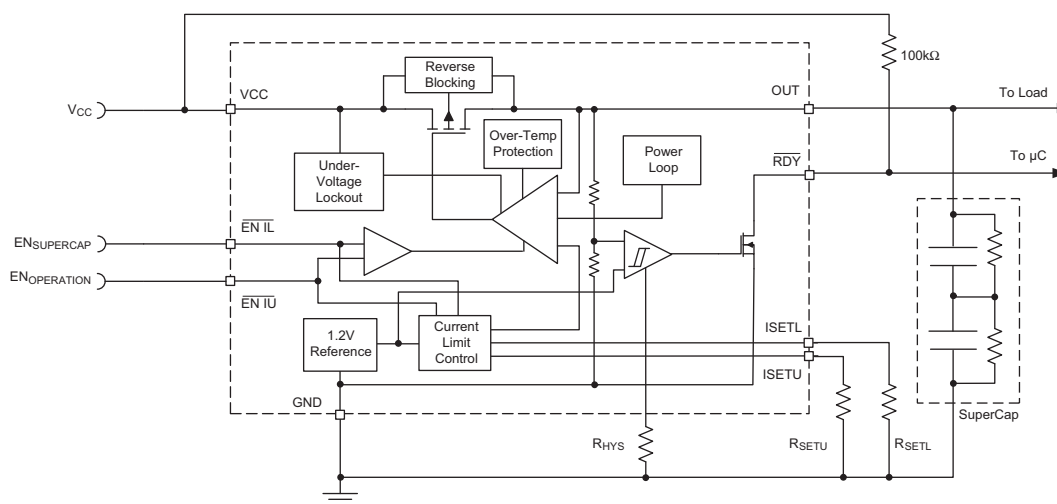

**PCMCIA Current Limit Interface and Capacitor Charger**

**Pin Descriptions**

Pin #	Symbol	Function
1	$\overline{\text{EN IU}}$	Enable input. Active low enable with internal pull up. Also switches in the higher current limit to allow the System to start functioning. Can be directly connected to System Ready for automatic enabling. When both $\overline{\text{EN IL}}$ and $\overline{\text{EN IU}}$ are enabled, $I_{\text{SETU}}$ will be selected.
2	$\overline{\text{EN IL}}$	Enable input. Active low enable with internal pull up. Also switches in the lower current limit initiating the super capacitor to start charging.
3	GND	Device ground connection.
4, 5, 6	VCC	Input pins to the P-channel MOSFET source. Connect 1 $\mu$ F capacitor from VCC to GND.
7, 8	OUT	P-channel MOSFET drain connection. Connect to super capacitor from OUT to GND.
9	ISETL	Lower current-limit set input. A resistor from ISETL to ground sets the maximum lower current limit for the switch. Current limit can be set between 100mA and 1200mA.
10	ISETU	Upper current limit set input. A resistor from ISETU to ground sets the maximum upper current limit for the switch. Current limits can be set between 100mA and 1200mA. Connect to ground to disable current limit.
11	RHYS	System READY hysteresis. Connect a resistor to ground to set the System Ready comparator hysteresis.
12	$\overline{\text{RDY}}$	System ready pin. Open drain, active low, initiated when the capacitor is 98% charged.

**Pin Configuration**

**TSOPJW-12  
(Top View)**

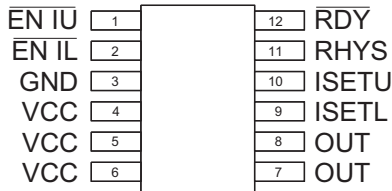

**PCMCIA Current Limit Interface and Capacitor Charger****Absolute Maximum Ratings<sup>1</sup>**

Symbol	Description	Value	Units
$V_{CC}$	VCC to GND	-0.3 to 6	V
$V_{EN}$	EN to GND	-0.3 to $V_{CC} + 0.3$	V
$V_{SET}, V_{OUT}$	SET, OUT to GND	-0.3 to $V_{CC} + 0.3$	V
$I_{MAX}$	Maximum Continuous Switch Current	2.5	A

**Thermal Characteristics**

Symbol	Description	Value	Units
$\theta_{JA}$	Maximum Thermal Resistance <sup>2</sup>	160	°C/W
$P_D$	Maximum Power Dissipation <sup>2</sup>	625	mW
$T_J$	Operating Junction Temperature Range	-40 to 150	°C

1. Stresses above those listed in Absolute Maximum Ratings may cause permanent damage to the device. Functional operation at conditions other than the operating conditions specified is not implied. Only one Absolute Maximum Rating should be applied at any one time.
2. Mounted on an FR4 board.

# DATA SHEET

# AAT4620

## PCMCIA Current Limit Interface and Capacitor Charger

### Electrical Characteristics<sup>1</sup>

$V_{CC} = 3.0V$  to  $5.5V$ ,  $T_A = -40^{\circ}C$  to  $85^{\circ}C$  unless otherwise noted. Typical values are at  $T_A = 25^{\circ}C$ .

Symbol	Description	Conditions	Min	Typ	Max	Units
$V_{CC}$	Operation Voltage		3.0		5.5	V
$I_Q$	Quiescent Current	$\overline{EN\ IL}$ or $\overline{EN\ IU} = V_{CC}$ , $I_{OUT} = 0$ , $R_{HYS} = 200k\Omega$		40	75	$\mu A$
$I_{QU0}$	Quiescent Current $U_0$	$\overline{EN\ IL} = V_{CC}$ , $\overline{EN\ IU} = GND$ , $I_{OUT} = 0$ , $I_{SET} = GND$ , $R_{HYS} = 200k\Omega$				
$I_{Q(OFF)}$	Off Supply Current	$\overline{EN\ IL} = \overline{EN\ IU} = V_{CC}$		0.4	1.0	$\mu A$
$I_{SD(OFF)}$	Off Switch Current	$\overline{EN\ IL} = \overline{EN\ IU} = V_{CC}$ , $V_{SUPERCAP} = 0$		0.4	10	$\mu A$
$V_{UVLO}$	Under-Voltage Lockout	Rising edge, 1% hysteresis		2.7	3.0	V
$R_{DS(ON)}$	On-Resistance	$V_{CC} = 4.75V$ , $R_{SETL} = R_{SETU} = 0k$		50	100	$m\Omega$
		$V_{CC} = 3.0V$ , $R_{SETL} = R_{SETU} = 0k$		65	120	
$I_{LIMLACC}$	Lower Current Limit Accuracy	$R_{SETL} = 249k\Omega$ ; $\Delta T_A \leq 20^{\circ}C$	180	200	220	$mA$
		$R_{SETL} = 249k\Omega$	170	200	230	
$I_{LIMUACC}$	Upper Current Limit Accuracy	$R_{SETU} = 1.24M\Omega$ ; $\Delta T_A \leq 20^{\circ}C$	900	1000	1100	$mA$
		$R_{SETU} = 1.24M\Omega$	850	1000	1150	
$I_{LIM(MIN)}$	Lower Minimum Current Limit			75		$mA$
$V_{EN(L)}$	EN Input Low Voltage	$V_{CC} = 3.0V$ to $5.5V2$			0.4	V
$V_{EN(H)}$	EN Input High Voltage	$V_{CC} = 3.0V$ to $5.5V2$	1.4			V
$I_{EN(SINK)}$	EN Input Leakage	$V_{EN} = 5.5V$			1.0	$\mu A$
$T_{DEL(OFF)}$	Turn-Off Delay Time	$V_{CC} = 5V$		0.4	1.0	$\mu s$
$V_{RDY}$	System READY Trip Threshold	$V_{OUT}$ rising, $T_A = 25^{\circ}C$		98		% of $V_{OUT}$
$V_{RDYHYS}$	System READY Hysteresis	$R_{HYS} = 200k\Omega$		200		mV
$V_{RDY(L)}$	System READY Voltage Low	$I_{SINK} = 1mA$			0.4	V
$I_{RDY}$	RDY Leakage Current	$V_{RDY} < 5.5V$ , $V_{OUT} < 98\%$ of $V_{OUT}$			1.0	$\mu A$
OTMP	Shutdown Temperature			145		$^{\circ}C$

1. The AAT4620 is guaranteed to meet performance specification over the  $-40^{\circ}C$  to  $85^{\circ}C$  operating temperature range and is assured by design, characterization and correlation with statistical process controls.

2. For  $V_{IN}$  outside this range consult the Typical EN Threshold curve.

## PCMCIA Current Limit Interface and Capacitor Charger

### Typical Characteristics

**Output Current vs. Output Voltage**  
( $R_{SETU} = 383k\Omega$ ,  $25^\circ C$ )

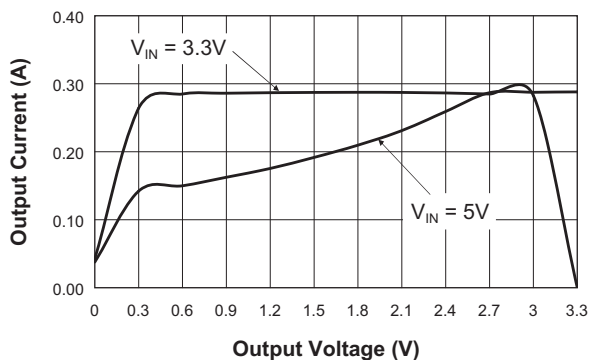

**$R_{SET}$  vs.  $I_{LIM}$**   
( $25^\circ C$ )

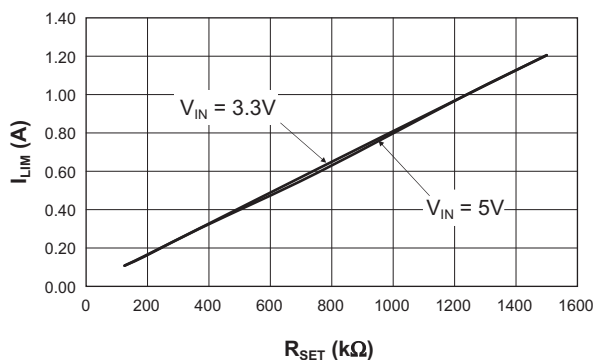

**Reverse Off-Switch Current vs. Temperature**  
( $E_{NUB} = E_{NLB} = V_{CC}$ ;  $V_{IN} = 0V$ )

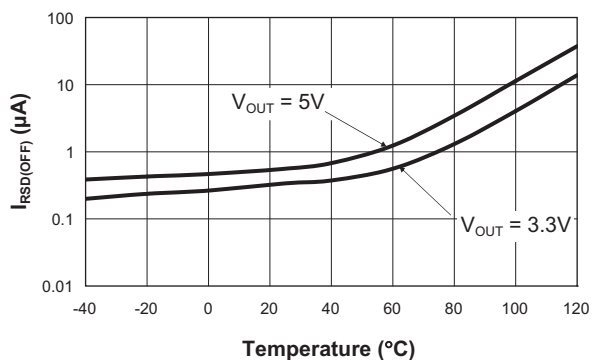

**Off-Switch Current vs. Temperature**  
( $E_{NUB} = E_{NLB} = V_{CC}$ ;  $V_{OUT} = 0V$ )

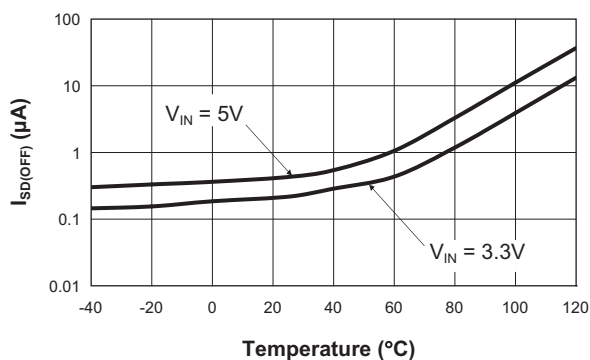

**Off-Supply Current vs. Temperature**  
( $E_{NUB} = E_{NLB} = V_{CC}$ ;  $V_{OUT} = \text{Open}$ )

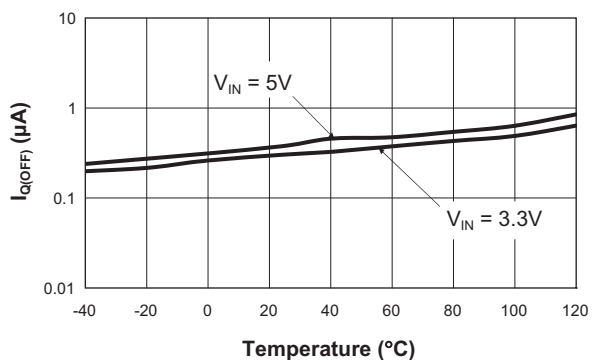

## PCMCIA Current Limit Interface and Capacitor Charger

### Typical Characteristics

**$R_{DS(ON)}$  vs. Input Voltage**  
( $R_{SET} = 0k\Omega$ )

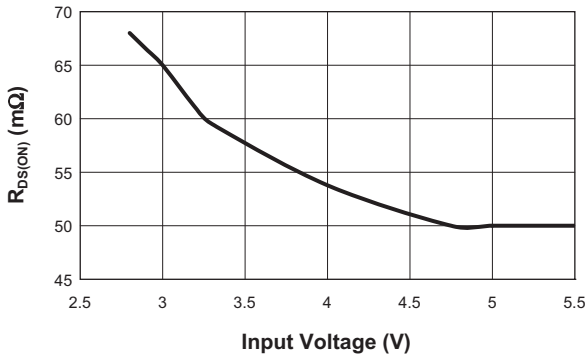

**$R_{DS(ON)}$  vs. Temperature**  
( $R_{SET} = 0\Omega$ )

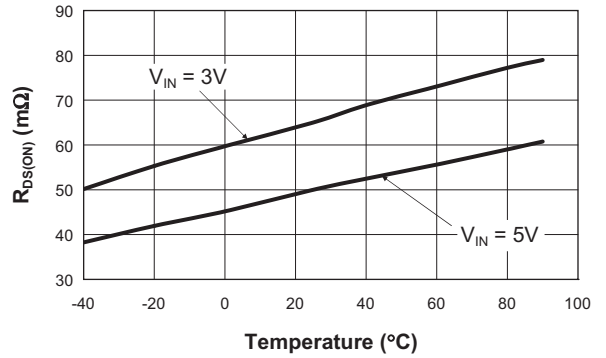

**$V_{RHYS}$  vs.  $R_{RHYS}$**

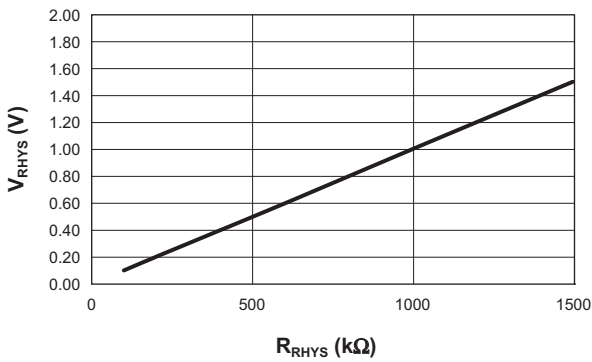

**$I_{LIM}$  vs. Temperature**  
( $V_{IN} = 4V$ ;  $V_{OUT} = 3.85V$ ;  $ENLB = 0V$ ;  $R_{SET} = 249k\Omega$ )

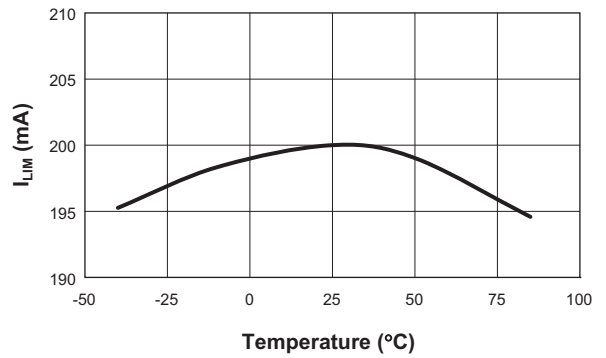

**$I_{LIM}$  vs. Temperature**  
( $V_{IN} = 4V$ ;  $V_{OUT} = 3.85V$ ;  $ENUB = 0V$ ;  $R_{SET} = 1.24M\Omega$ )

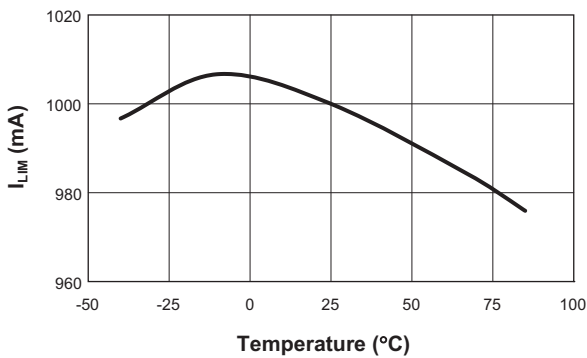

**Quiescent Current  $I_{QL}$  vs. Temperature**  
( $ENLB = 0V$ ;  $ENUB = V_{CC}$ ;  $V_{OUT} = Open$ )

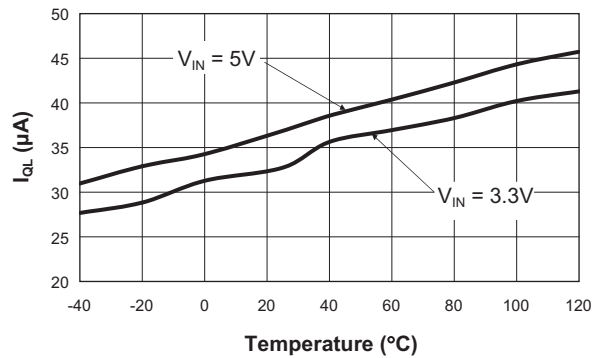

## PCMCIA Current Limit Interface and Capacitor Charger

### Typical Characteristics

**$V_{IL}$  vs. Input Voltage**  
( $E_{NUB}$  = Open; Vary  $E_{NLB}$ ; 25°C)

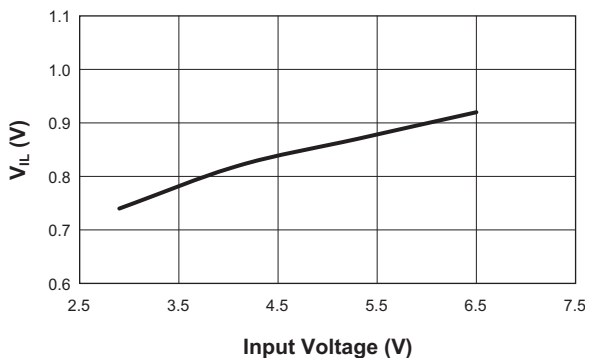

**$V_{IH}$  vs. Input Voltage**  
( $E_{NUB}$  = Open; Vary  $E_{NLB}$ ; 25°C)

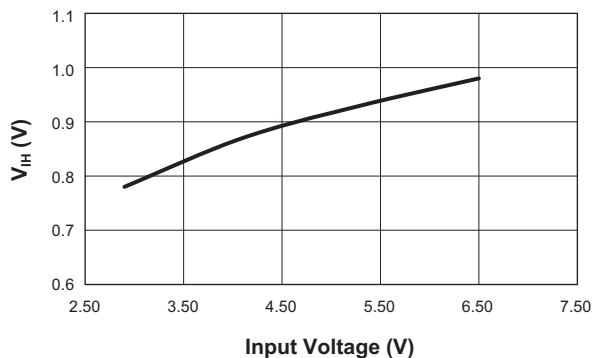

**$V_{IL}$  vs. Input Voltage**  
( $E_{NLB}$  = Open; Vary  $E_{NUB}$ ; 25°C)

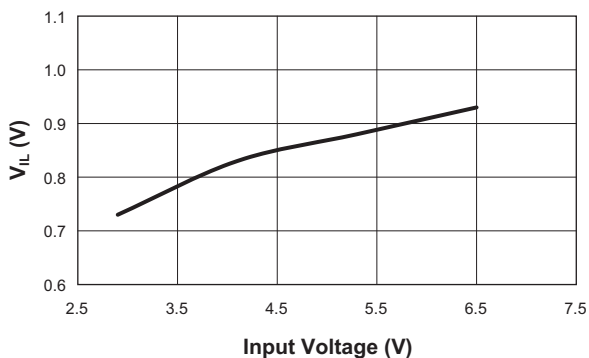

**$V_{IH}$  vs. Input Voltage**  
( $E_{NLB}$  = Open; Vary  $E_{NUB}$ ; 25°C)

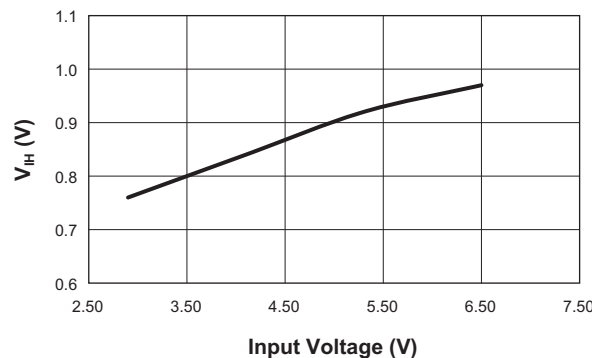

**Short Circuit with 5Ω Series Impedance**  
( $V_{IN} = 3.3V$ )

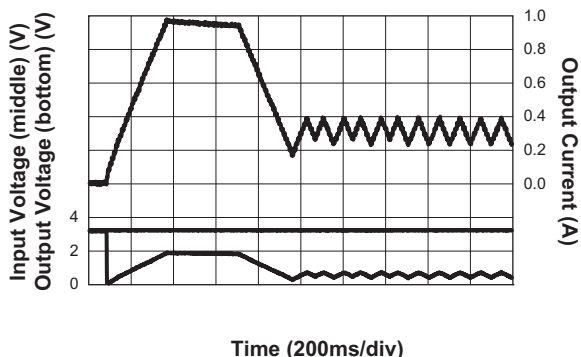

**Soft Short Circuit with 5Ω Series Impedance**  
( $V_{IN} = 5V$ )

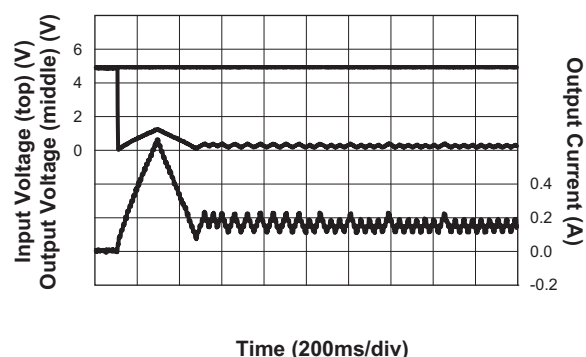

## PCMCIA Current Limit Interface and Capacitor Charger

### Typical Characteristics

**Hard Short Circuit**  
( $V_{IN} = 3.3V$ )

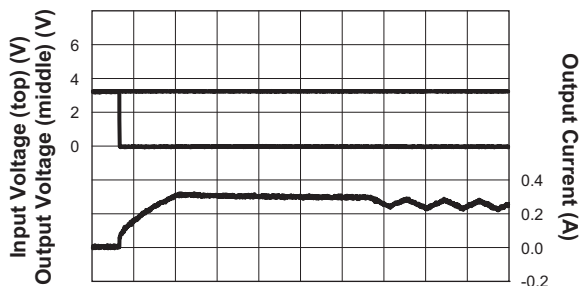

Time (200ms/div)

**Hard Short Circuit**  
( $V_{IN} = 5V$ )

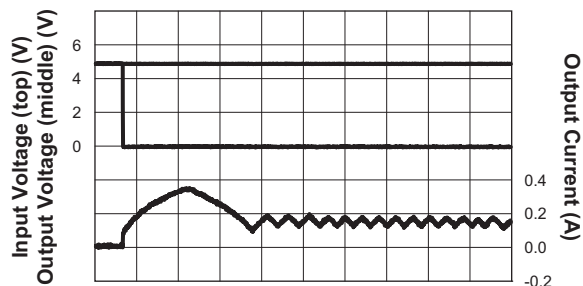

Time (200ms/div)

**Charging Profile**  
( $I_{LIMIT} = 150mA$ ;  $V_{IN} = 5V$ ;  $C_O = 0.55F$ )

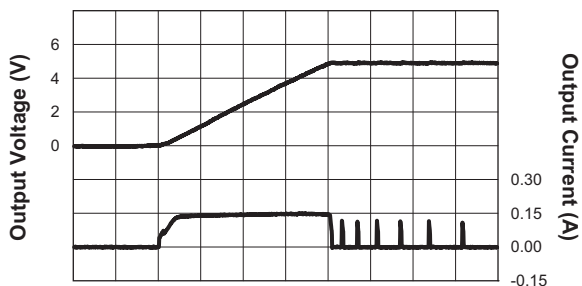

Time (5s/div)

**Charging Profile**  
( $I_{LIMIT} = 150mA$ ;  $V_{IN} = 5V$ ;  $C_O = 0.55F$ )

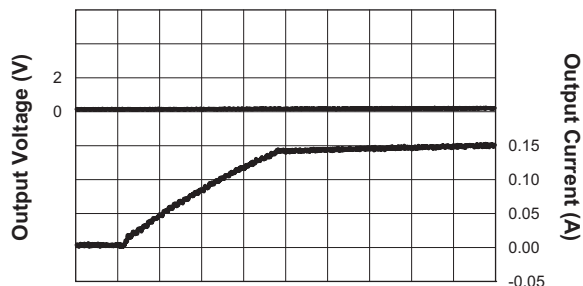

Time (20ms/div)

**Charging Profile**  
( $I_{LIMIT} = 1A$ ;  $V_{IN} = 5V$ ;  $C_O = 0.55F$ )

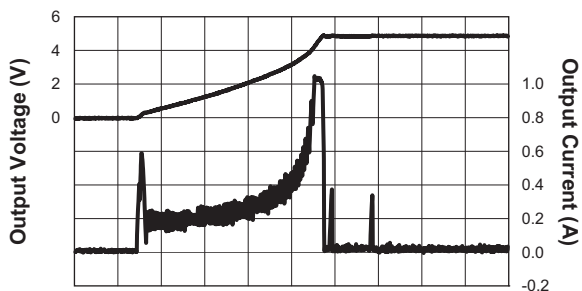

Time (2s/div)

**Charging Profile**  
( $V_{IN} = 5V$ ,  $V_{ISETL} = V_{ISETU} = 0V$ ,  $C_O = 0.55F$ )

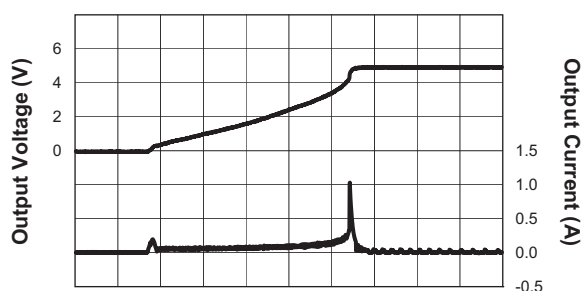

Time (2s/div)



## PCMCIA Current Limit Interface and Capacitor Charger

### Functional Block Diagram

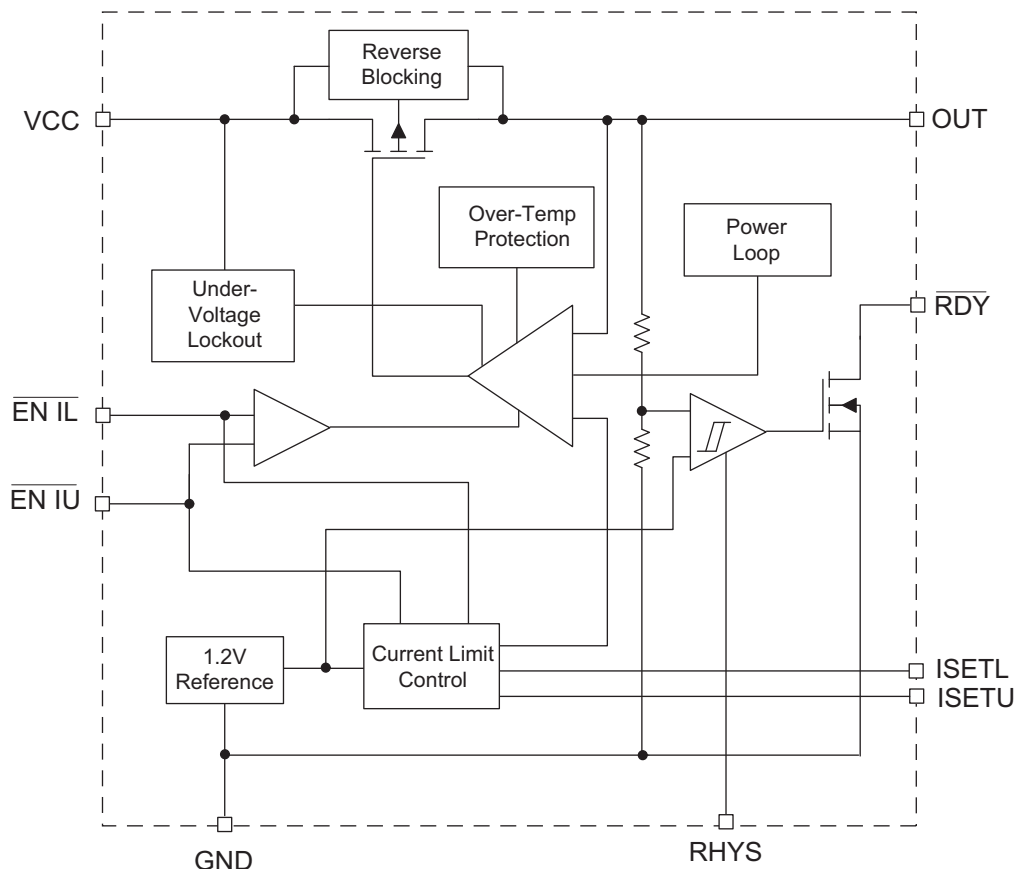

### Functional Description

The AAT4620 is an integrated P-channel MOSFET load switch with an upper and lower adjustable current limits which can be enabled independently, over-temperature protection, a power loop and a super capacitor charger. The current limit control is combined with an over temperature thermal limit and power loop circuit to provide a comprehensive system to protect the load switch and its supply from load conditions which exceed the supply specifications. The AAT4620 has been designed specifically to provide the interface between a PCMCIA host and PCMCIA card where a super capacitor has been used

to “average out” high pulse currents which would otherwise exceed the PCMCIA/ Express Card power specifications. e.g. GSM/ GPRS modem cards, where pulse currents during transmit signals can exceed the 1A maximum specification (1.3A in the case of Express Card).

The current limit and over temperature circuits act independently. The device current limit is activated when the output load current exceeds an internal threshold level. There are two internal current limits which are enabled independently. The current limit threshold in each case is determined by external resistors connected between the two SET pins and ground. The minimum current limit

**PCMCIA Current Limit Interface and Capacitor Charger**

threshold is specified by  $I_{LIM(MIN)}$ . If the load condition maintains the device in current limit and the chip temperature reaches a critical point, then an internal power loop will reduce the current to a safe level. Connecting ISETU to ground disables the current limit protection allowing a low impedance path to the host  $V_{CC}$ .

The load switch is turned off by applying a logic high level to both of the EN pins. When both  $\overline{EN\ IL}$  and  $\overline{EN\ IU}$  are selected ISETU will be selected. The EN function has logic level thresholds that allow the AAT4620 to be TTL compatible and may also be controlled by 2.5V to 5.0V CMOS circuits. The voltage level applied to the EN pins should not exceed the input supply level present on the VCC pin. The AAT4620 typically consumes 40 $\mu$ A when operating, when off, the device draws less than 1 $\mu$ A. In the off state, current is prevented from flowing between the input and output.

Under-voltage lockout circuitry ensures that the  $V_{CC}$  supply is high enough for correct operation of the IC. Also included is a System Ready function which will be activated when the capacitor voltage is charged and the load is permitted to take current. For automatic functionality, this pin can be directly connected to the  $\overline{EN\ IU}$  pin. An external resistor is provided to add hysteresis to this function.

## Application Information

### ISETU and ISETL Current Limit Set

The AAT4620 current limit is set at two different levels. Resistors from ISETL and ISETU set the lower and upper current limit levels respectively.

The ISETL and ISETU nodes operate within a window of 0.75V to 1.5V for resistor values ranging from 93.75 $\Omega$  to 1.5M $\Omega$ . Resistor values outside this range are not recommended. The ISETL and ISETU source current varies with the resistor value used according to Table 1. To determine the resulting current limit multiply the  $R_{SETU}$  or  $R_{SETL}$  node voltage times the gain in Table 1. Note that the voltage at the node varies from 0.75V to 1.5V and the current limit gain varies depending on the resistor value used.

$$V_{ISET} = R_{SET} \cdot I_{ISET} = 0.75V \text{ to } 1.5V$$

If the set pin is open circuit or allowed to exceed 2V, all power devices are disabled and the input is disconnected from the output. Shorting the set pin to GND enables all power devices and shorts the  $V_{CC}$  to the output pin with no current limit.

To activate the upper current level ( $R_{SETU}$ ) pull  $\overline{EN\ IU}$  low. To activate the lower current level ( $R_{SETL}$ ) pull  $\overline{EN\ IL}$  low. If both  $\overline{EN\ IU}$  and  $\overline{EN\ IL}$  are pulled low the  $\overline{EN\ IU}$  current limit level ( $R_{SETU}$ ) will be selected.

$R_{SET}$ Range	$I_{ISET}$ ( $\mu$ A)	$I_{LIM}/V_{ISET}$ (A/V)	Current Limit Range (A)	Current Limit
1.5Meg - 750k	1	0.8	1.2-0.6	$R_{SET} * 1\mu A * 0.8$
750k - 375k	2	0.4	0.6-0.3	$R_{SET} * 2\mu A * 0.4$
375k - 187.5k	4	0.2	0.3-0.15	$R_{SET} * 4\mu A * 0.2$
187.5 - 93.75k	8	0.1	0.15-0.075	$R_{SET} * 8\mu A * 0.1$

**Table 1:  $R_{SET}$  Table.**

## PCMCIA Current Limit Interface and Capacitor Charger

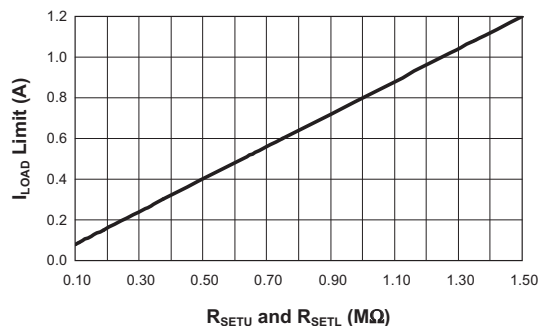

**Figure 1: Calculated Current Limit R<sub>SET</sub> Characteristic.**

### System Ready Hysteresis (RHYS) and System Ready (RDY)

In internal comparator senses the output voltage and delivers a ready signal to the external micro controller when the output voltage reaches 98% of the final value ( $V_{CC}$ ). The comparator hysteresis is programmed by a resistor from the RHYS pin to ground. The RHYS voltage determines the hysteresis voltage and is equal to the RHYS source current ( $1\mu\text{A}$ ) times the RHYS resistance.

$$\begin{aligned} V_{\text{HYST}} &= R_{\text{HYS}} \cdot 1\mu\text{A} \\ &= 200\text{k}\Omega \cdot 1\mu\text{A} \\ &= 0.2\text{V} \end{aligned}$$

The system ready pin ( $\overline{\text{RDY}}$ ) is an open drain output that switches low when the output voltage reaches 98% of the input voltage. It requires an external pull up resistor tied to the input voltage with a typical value of  $100\text{k}\Omega$ .

### Power Loop

The AAT4620 power loop limits the load current in the event that the device power dissipation becomes excessive. The AAT4620 power loop regulates the die temperature to  $100^\circ\text{C}$ , decreasing the load current in increments of  $1/32$  of the current limit set point when the die temperature reaches  $100^\circ\text{C}$ . When the die temperature

exceeds  $100^\circ\text{C}$  it decreases the load current by  $1/32$  of the current limit set point. If die temperature is less than  $100^\circ\text{C}$ , it increases the load current in increments of  $1/32$  of the current limit set point until the set current limit point is reached or the die temperature exceeds  $100^\circ\text{C}$ .

The delay time between die temperature measurements varies depending on the load current limit set point. The delay ranges from 1ms for a 75mA current limit set point to 8ms for a 1.5A current limit set point.

For the condition where there is no current limit set point (shorting  $R_{\text{SETU}}$  or  $R_{\text{SETL}}$  to ground) the soft start increments the current limit is  $1/32$  steps of 1.2A until the current reaches 1.2A, at which point the power MOSFET turns on fully. At this point, the current is limited by the  $R_{\text{DS(ON)}}$  of the power MOSFET and other series resistance. The Power Loop and Over-Temperature Loop then takes control to limit the current until the output voltage has fully charged.

### Over-Temperature Protection

If the die temperature rate of rise is fast enough to exceed the power loop regulated temperature, over-temperature shutdown disables the device. The over-temperature threshold is  $145^\circ\text{C}$ . After over-temperature shutdown, soft start is initiated once the die temperature drops to  $130^\circ\text{C}$ .

### Short Circuit Protection

The series pass power MOSFET turns off completely after the output has charged to within 18mV of the input voltage. This protects the device in the event of a short circuit applied to the output. Applying a short circuit or heavy load to the output initiates the digital soft start where the current ramps from zero to the final programmed value. The power loop will be activated once the digital soft start begins.

### Under-Voltage Shutdown

Under-voltage lockout enables the device at 2.7V typical with 100mV of hysteresis. The maximum UVLO level is 3.0V.

## PCMCIA Current Limit Interface and Capacitor Charger

### Digitally Programmed Soft Start Current Limit

At turn on, the digital soft start increases the load current in discrete levels equal to 1/32 of the final programmed current limit set point from zero to the final programmed current limit level.

### Reverse Current Blocking

An internal comparator disables the internal pass transistor when the input voltage is less than the output voltage blocking any reverse current from the output to the input.

### Evaluation Board

The evaluation board schematic is shown in Figure 2. The PCB layout is shown in Figures 3 and 4.

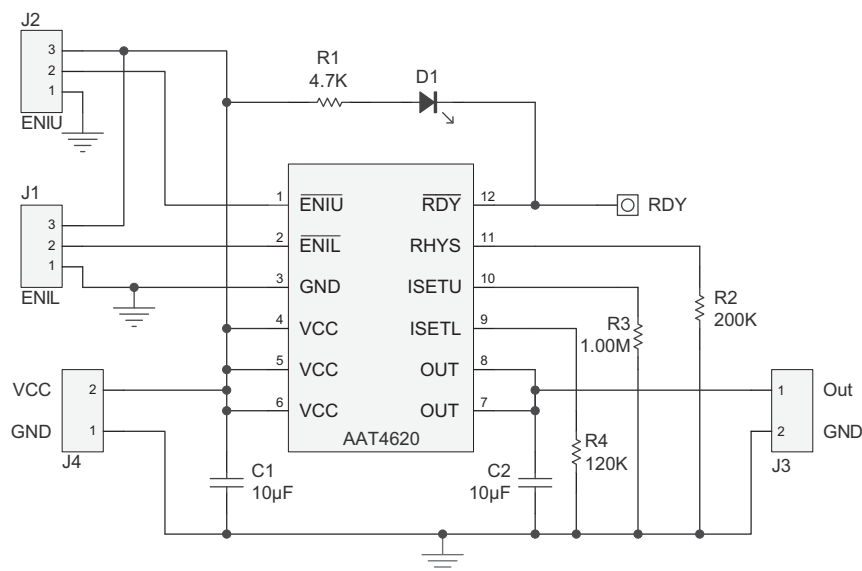

**Figure 2: AAT4620 Evaluation Board Schematic.**

# AAT4620

## PCMCIA Current Limit Interface and Capacitor Charger

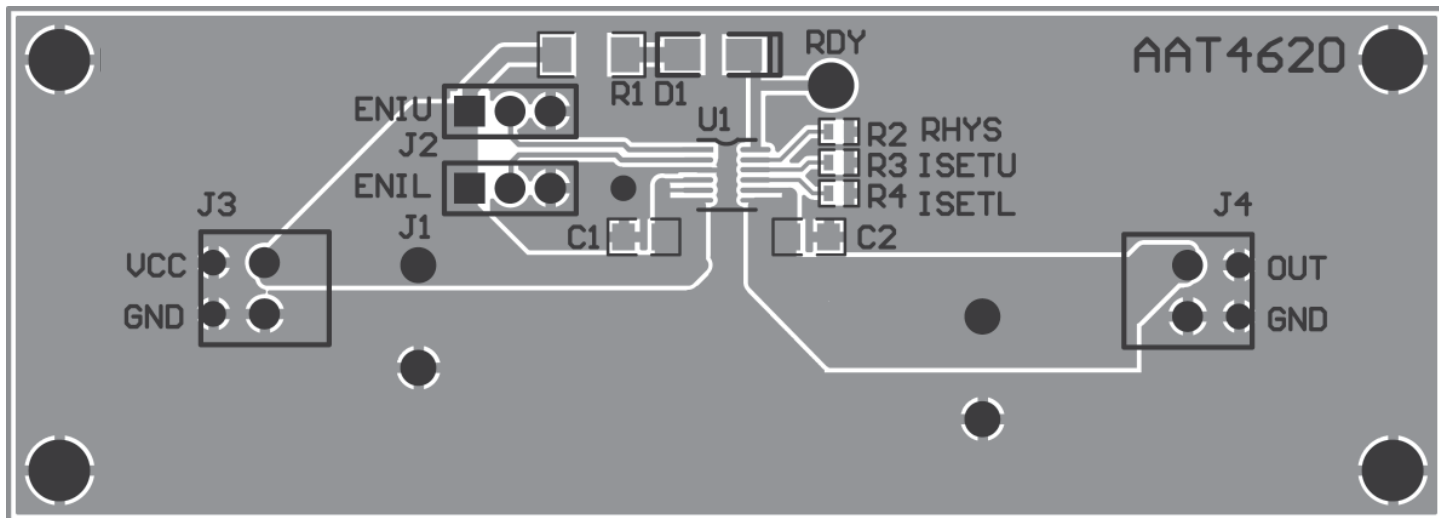

Figure 3: AAT4620 Evaluation Board PCB Top Side.

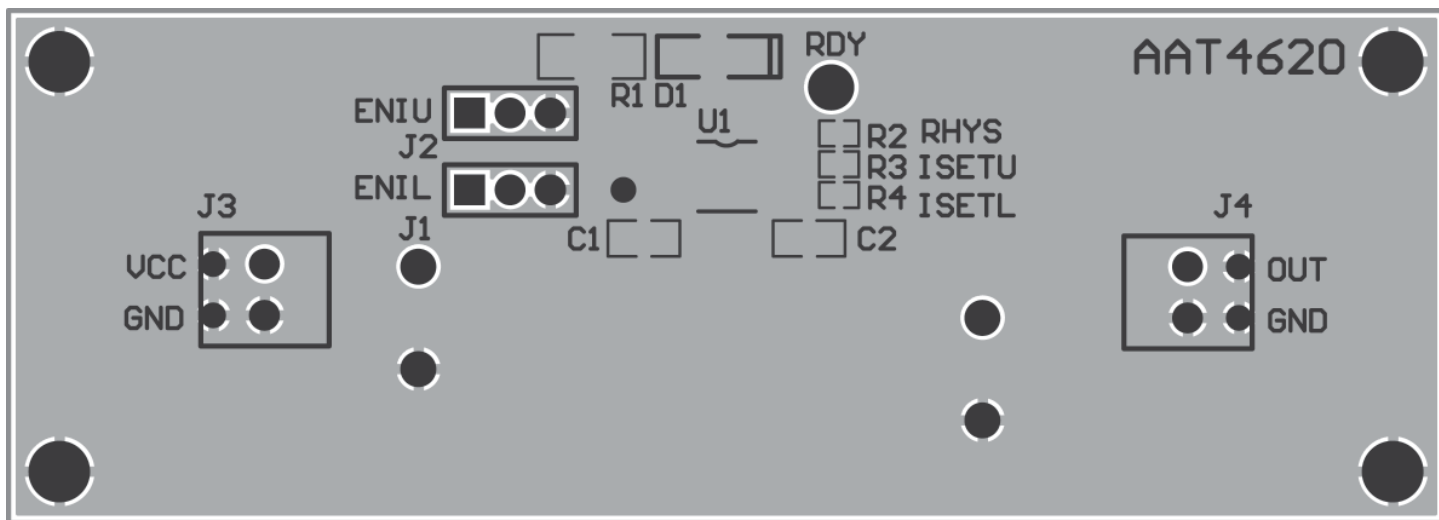

Figure 4: AAT4620 Evaluation Board PCB Bottom Side.

# AAT4620

## PCMCIA Current Limit Interface and Capacitor Charger

### Ordering Information

Package	Marking <sup>1</sup>	Part Number (Tape and Reel) <sup>2</sup>
TSOPJW-12	UZXY	<b>AAT4620ITP-T1</b>



Skyworks Green™ products are compliant with all applicable legislation and are halogen-free. For additional information, refer to *Skyworks Definition of Green™*, document number SQ04-0074.

### Package Information

#### TSOPJW-12

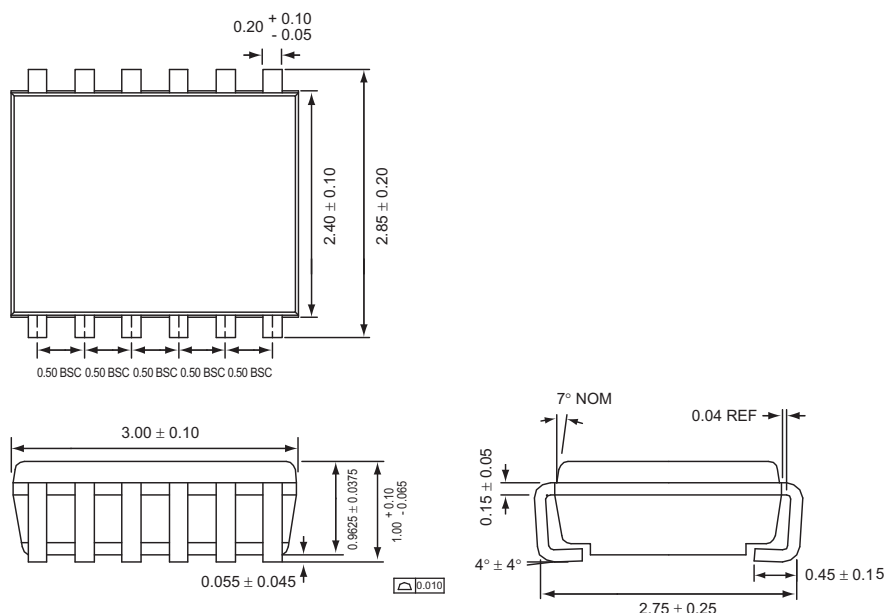

All dimensions in millimeters.

1. XYY = assembly and date code.
2. Sample stock is generally held on part numbers listed in **BOLD**.

Copyright © 2012 Skyworks Solutions, Inc. All Rights Reserved.

Information in this document is provided in connection with Skyworks Solutions, Inc. ("Skyworks") products or services. These materials, including the information contained herein, are provided by Skyworks as a service to its customers and may be used for informational purposes only by the customer. Skyworks assumes no responsibility for errors or omissions in these materials or the information contained herein. Skyworks may change its documentation, products, services, specifications or product descriptions at any time, without notice. Skyworks makes no commitment to update the materials or information and shall have no responsibility whatsoever for conflicts, incompatibilities, or other difficulties arising from any future changes.

No license, whether express, implied, by estoppel or otherwise, is granted to any intellectual property rights by this document. Skyworks assumes no liability for any materials, products or information provided hereunder, including the sale, distribution, reproduction or use of Skyworks products, information or materials, except as may be provided in Skyworks Terms and Conditions of Sale.

THE MATERIALS, PRODUCTS AND INFORMATION ARE PROVIDED "AS IS" WITHOUT WARRANTY OF ANY KIND, WHETHER EXPRESS, IMPLIED, STATUTORY, OR OTHERWISE, INCLUDING FITNESS FOR A PARTICULAR PURPOSE OR USE, MERCHANTABILITY, PERFORMANCE, QUALITY OR NON-INFRINGEMENT OF ANY INTELLECTUAL PROPERTY RIGHT; ALL SUCH WARRANTIES ARE HEREBY EXPRESSLY DISCLAIMED. SKYWORKS DOES NOT WARRANT THE ACCURACY OR COMPLETENESS OF THE INFORMATION, TEXT, GRAPHICS OR OTHER ITEMS CONTAINED WITHIN THESE MATERIALS. SKYWORKS SHALL NOT BE LIABLE FOR ANY DAMAGES, INCLUDING BUT NOT LIMITED TO ANY SPECIAL, INDIRECT, INCIDENTAL, STATUTORY, OR CONSEQUENTIAL DAMAGES, INCLUDING WITHOUT LIMITATION, LOST REVENUES OR LOST PROFITS THAT MAY RESULT FROM THE USE OF THE MATERIALS OR INFORMATION, WHETHER OR NOT THE RECIPIENT OF MATERIALS HAS BEEN ADVISED OF THE POSSIBILITY OF SUCH DAMAGE.

Skyworks products are not intended for use in medical, lifesaving or life-sustaining applications, or other equipment in which the failure of the Skyworks products could lead to personal injury, death, physical or environmental damage. Skyworks customers using or selling Skyworks products for use in such applications do so at their own risk and agree to fully indemnify Skyworks for any damages resulting from such improper use or sale.

Customers are responsible for their products and applications using Skyworks products, which may deviate from published specifications as a result of design defects, errors, or operation of products outside of published parameters or design specifications. Customers should include design and operating safeguards to minimize these and other risks. Skyworks assumes no liability for applications assistance, customer product design, or damage to any equipment resulting from the use of Skyworks products outside of stated published specifications or parameters.

Skyworks, the Skyworks symbol, and "Breakthrough Simplicity" are trademarks or registered trademarks of Skyworks Solutions, Inc., in the United States and other countries. Third-party brands and names are for identification purposes only, and are the property of their respective owners. Additional information, including relevant terms and conditions, posted at [www.skyworksinc.com](http://www.skyworksinc.com), are incorporated by reference.