

**DATA SHEET**

# AS219-321, AS219-321LF: PHEMT GaAs IC High-Linearity 3 V T/R SP3T Switch 0.1–2.5 GHz

**Features**

- 2.6 to 5 V linear operation
- Harmonics  $H_2, H_3 < -70$  dBc @  $P_{IN} = 34.5$  dBm
- Low Tx insertion loss (0.35 dB @ 0.9 GHz)
- High Rx isolation (25 dB @ 0.9 GHz)
- Miniature QFN-12 plastic package
- PHEMT process
- Available lead (Pb)-free and RoHS-compliant MSL-1 @ 260 °C per JEDEC J-STD-020

**Description**

The AS219-321 is a PHEMT GaAs IC SP3T antenna switch operating in the 900 MHz and 1800 MHz frequency bands. Switching between the antenna and Tx/Rx ports is accomplished with three control inputs. When the control inputs are driven with the appropriate voltages, a low insertion loss path is provided from an antenna port to a Tx port, while the other Rx ports have high attenuation.

**NEW** Skyworks offers lead (Pb)-free, RoHS (Restriction of Hazardous Substances)-compliant packaging.



**Pin Out (Top View)**

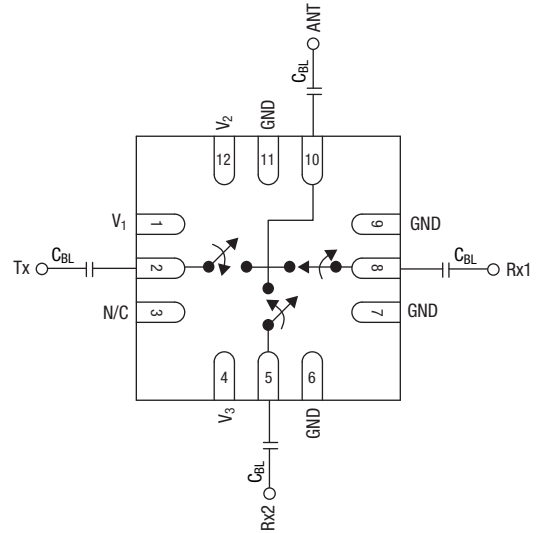

DC blocking capacitors ( $C_{BL}$ ) must be supplied externally for positive voltage operation.  $C_{BL} = 47$  pF for operation  $>500$  MHz.

**Electrical Specifications at 25 °C (0, 3 V)**

Parameter <sup>(1)</sup>	Condition	Frequency	Min.	Typ.	Max.	Unit
Insertion loss <sup>(2)</sup>	Ant-Rx	0.1–1.0 GHz		0.5	0.75	dB
		1.0–2.0 GHz		0.7	0.80	dB
		2.0–2.5 GHz		0.8	1.10	dB
	Ant-Tx	0.1–1.0 GHz		0.35	0.40	dB
		1.0–2.0 GHz		0.50	0.55	dB
		2.0–2.5 GHz		0.65	0.70	dB
Isolation	Ant-Rx	0.1–1.0 GHz	24	26		dB
		1.0–2.0 GHz	20	25		dB
		2.0–2.5 GHz	20	24		dB
	Ant-Tx	0.1–1.0 GHz	20	23		dB
		1.0–2.0 GHz	14	16		dB
		2.0–2.5 GHz	10	14		dB
VSWR <sup>(3)</sup>		0.1–2.5 GHz		1.1:1		dB

1. All measurements made in a 50 Ω system, unless otherwise specified.  
 2. Insertion loss changes by 0.003 dB/°C.  
 3. Insertion loss state.

### Operating Characteristics at 25 °C (0, 3 V)

Parameter	Condition	Frequency	Min.	Typ.	Max.	Unit
Switching characteristics						
Rise, fall	10/90% or 90/10% RF			60		ns
On, off	50% CTL to 90/10% RF			100		ns
Video feedthru	$T_{RISE} = 1 \text{ ns}$ , BW = 500 MHz			50		mV
Input power for -0.1 dB compression	0/3 V	0.9 GHz		35		dBm
Harmonics H <sub>2</sub> , H <sub>3</sub> (transmit state)	$P_{IN} = 34.5 \text{ dBm}$	0.9 GHz, 1.8 GHz		-70		dBc
Thermal resistance				25		°C/W
Control voltages	$V_{LOW} = 0 \text{ to } 0.2 \text{ V @ } 20 \text{ } \mu\text{A max.}$ $V_{HIGH} = 2.7 \text{ V @ } 100 \text{ } \mu\text{A max. to } 5 \text{ V @ } 200 \text{ } \mu\text{A max.}$					

### Typical Performance Data

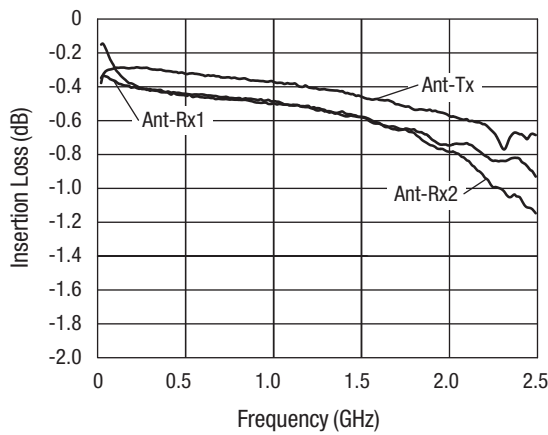

Insertion Loss vs. Frequency

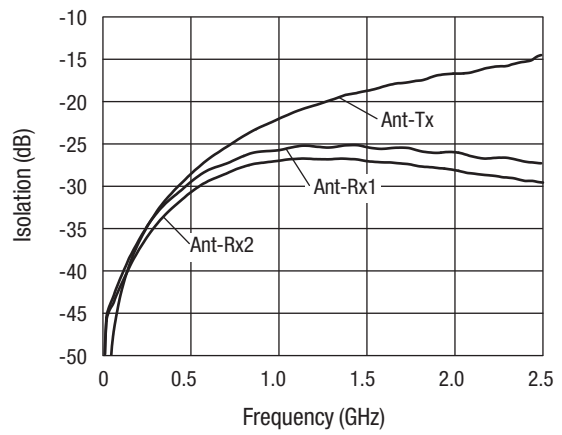

Isolation vs. Frequency

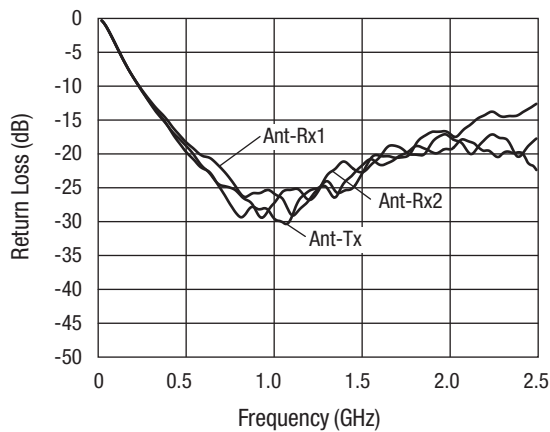

Return Loss vs. Frequency

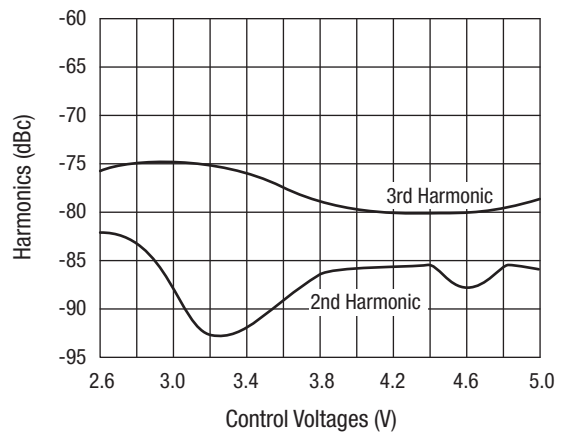

0.9 GHz Harmonics vs. Control Voltages

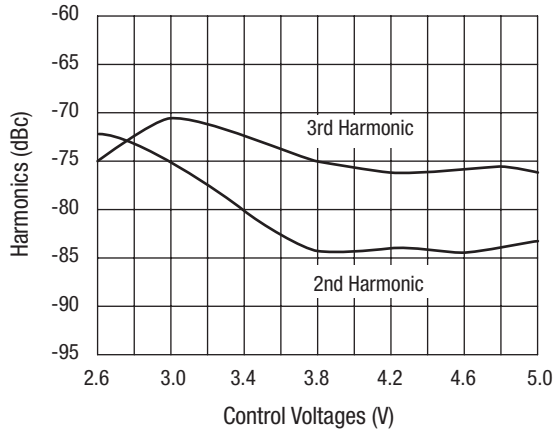

1.8 GHz Harmonics vs. Control Voltages

QFN-12

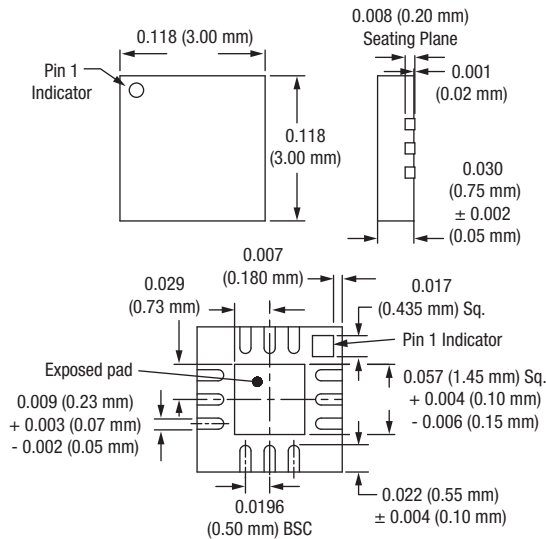

Package Marking

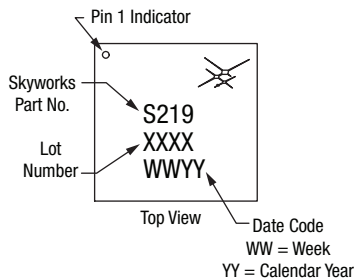

Truth Table

V <sub>1</sub>	V <sub>2</sub>	V <sub>3</sub>	Ant-Tx	Ant-Rx1	Ant-Rx2
V <sub>HIGH</sub>	V <sub>LOW</sub>	V <sub>LOW</sub>	Ins. loss	Isolation	Isolation
V <sub>LOW</sub>	V <sub>HIGH</sub>	V <sub>LOW</sub>	Isolation	Ins. loss	Isolation
V <sub>LOW</sub>	V <sub>LOW</sub>	V <sub>HIGH</sub>	Isolation	Isolation	Ins. loss

All other conditions not recommended.  
 V<sub>LOW</sub> = 0–0.2 V.  
 V<sub>HIGH</sub> = 2.75–5 V.

Absolute Maximum Ratings

Characteristic	Value
RF input power	6 W > 500 MHz 0/7 V control
Control voltage	-0.2 V, +8 V
Operating temperature	-40 °C to +85 °C
Storage temperature	-65 °C to +150 °C

Performance is guaranteed only under the conditions listed in the specifications table and is not guaranteed under the full range(s) described by the Absolute Maximum specifications. Exceeding any of the absolute maximum/minimum specifications may result in permanent damage to the device and will void the warranty.

**CAUTION:** Although this device is designed to be as robust as possible, ESD (Electrostatic Discharge) can damage this device. This device must be protected at all times from ESD. Static charges may easily produce potentials of several kilovolts on the human body or equipment, which can discharge without detection. Industry-standard ESD precautions must be employed at all times.

Recommended Solder Reflow Profiles

Refer to the [“Recommended Solder Reflow Profile”](#) Application Note.

Tape and Reel Information

Refer to the [“Discrete Devices and IC Switch/Attenuators Tape and Reel Package Orientation”](#) Application Note.

Copyright © 2002, 2003, 2004, 2005, 2006, 2007, Skyworks Solutions, Inc. All Rights Reserved.

Information in this document is provided in connection with Skyworks Solutions, Inc. ("Skyworks") products or services. These materials, including the information contained herein, are provided by Skyworks as a service to its customers and may be used for informational purposes only by the customer. Skyworks assumes no responsibility for errors or omissions in these materials or the information contained herein. Skyworks may change its documentation, products, services, specifications or product descriptions at any time, without notice. Skyworks makes no commitment to update the materials or information and shall have no responsibility whatsoever for conflicts, incompatibilities, or other difficulties arising from any future changes.

No license, whether express, implied, by estoppel or otherwise, is granted to any intellectual property rights by this document. Skyworks assumes no liability for any materials, products or information provided hereunder, including the sale, distribution, reproduction or use of Skyworks products, information or materials, except as may be provided in Skyworks Terms and Conditions of Sale.

THE MATERIALS, PRODUCTS AND INFORMATION ARE PROVIDED "AS IS" WITHOUT WARRANTY OF ANY KIND, WHETHER EXPRESS, IMPLIED, STATUTORY, OR OTHERWISE, INCLUDING FITNESS FOR A PARTICULAR PURPOSE OR USE, MERCHANTABILITY, PERFORMANCE, QUALITY OR NON-INFRINGEMENT OF ANY INTELLECTUAL PROPERTY RIGHT; ALL SUCH WARRANTIES ARE HEREBY EXPRESSLY DISCLAIMED. SKYWORKS DOES NOT WARRANT THE ACCURACY OR COMPLETENESS OF THE INFORMATION, TEXT, GRAPHICS OR OTHER ITEMS CONTAINED WITHIN THESE MATERIALS. SKYWORKS SHALL NOT BE LIABLE FOR ANY DAMAGES, INCLUDING BUT NOT LIMITED TO ANY SPECIAL, INDIRECT, INCIDENTAL, STATUTORY, OR CONSEQUENTIAL DAMAGES, INCLUDING WITHOUT LIMITATION, LOST REVENUES OR LOST PROFITS THAT MAY RESULT FROM THE USE OF THE MATERIALS OR INFORMATION, WHETHER OR NOT THE RECIPIENT OF MATERIALS HAS BEEN ADVISED OF THE POSSIBILITY OF SUCH DAMAGE.

Skyworks products are not intended for use in medical, lifesaving or life-sustaining applications, or other equipment in which the failure of the Skyworks products could lead to personal injury, death, physical or environmental damage. Skyworks customers using or selling Skyworks products for use in such applications do so at their own risk and agree to fully indemnify Skyworks for any damages resulting from such improper use or sale.

Customers are responsible for their products and applications using Skyworks products, which may deviate from published specifications as a result of design defects, errors, or operation of products outside of published parameters or design specifications. Customers should include design and operating safeguards to minimize these and other risks. Skyworks assumes no liability for applications assistance, customer product design, or damage to any equipment resulting from the use of Skyworks products outside of stated published specifications or parameters.

Skyworks, the Skyworks symbol, and "Breakthrough Simplicity" are trademarks or registered trademarks of Skyworks Solutions, Inc., in the United States and other countries. Third-party brands and names are for identification purposes only, and are the property of their respective owners. Additional information, including relevant terms and conditions, posted at [www.skyworksinc.com](http://www.skyworksinc.com), are incorporated by reference.