

DATA SHEET

# DSM8100-000: Mesa Beam-Lead PIN Diode

## Applications:

- Designed for switching applications

## Features

- Low capacitance
- Low resistance
- Fast switching
- Oxide-nitride passivated
- Durable construction
- Lead (Pb)-free, RoHS-compliant, and Green™



## Description

Skyworks Silicon Mesa Beam-Lead PIN diode is surrounded by a glass frame for superior strength and electrical performance that surpasses the standard beam-lead PINs. The DSM8100-000 is designed for low resistance, low capacitance and fast switching time. The oxide-nitride passivation layers provide reliable operation and stable junction parameters that provide complete sealing of the junction permitting use in assemblies with some degree of moisture sealing. A layer of glass provides increased mechanical strength.

The DSM8100 is designed for microstrip or stripline circuits and for circuits requiring high isolation from a series-mounted diode such as broadband multithrow switches, phase shifters, limiters, attenuators and modulators.

**NEW**



Skyworks Green™ products are RoHS (Restriction of Hazardous Substances)-compliant, conform to the EIA/EICTA/JEITA Joint Industry Guide (JIG) Level A guidelines, are halogen free according to IEC-61249-2-21, and contain <1,000 ppm antimony trioxide in polymeric materials.

## Absolute Maximum Ratings

Characteristic	Value
Operating temperature	-65 °C to +150 °C
Storage temperature	-65 °C to +200 °C
Power dissipation (derate linearly to zero @ 175 °C)	250 mW
Typical lead strength	8 grams pull
Reverse voltage	60 V

Performance is guaranteed only under the conditions listed in the specifications table and is not guaranteed under the full range(s) described by the Absolute Maximum Ratings. Exceeding any of the absolute maximum/minimum specifications may result in permanent damage to the device and will void the warranty.

**CAUTION:** Although these devices are designed to be robust, ESD (Electrostatic Discharge) can cause permanent damage. Static charges may easily produce potentials of several kilovolts on the human body or equipment, which can discharge without detection. Industry-standard ESD precautions must be employed at all times.

### Mesa Beam-Lead Diode Specifications

Part Number	Min. Voltage Rating <sup>(1)</sup> (V)	Max. Total Capacitance 10 V, 1 MHz (pF)	Max. Series Resistance 10 mA, 100 MHz ( $\Omega$ )	Typ. $T_L$ $I_F = 10$ mA (ns)	Outline Drawing
DSM8100-000	60	0.025	3.5	25	389-003

1. Reverse current is specified at 10  $\mu$ A maximum at the voltage rating. This voltage should not be exceeded.

### Typical Performance Data

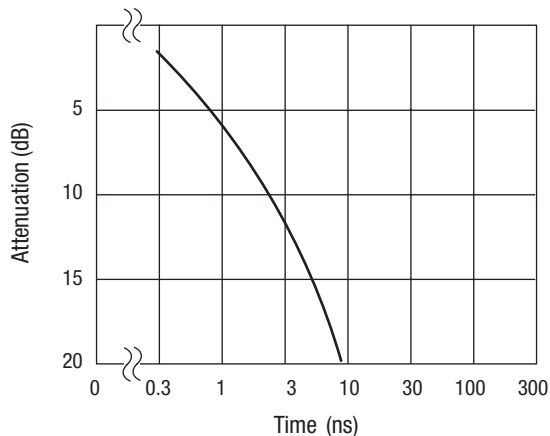

Switching Time Data

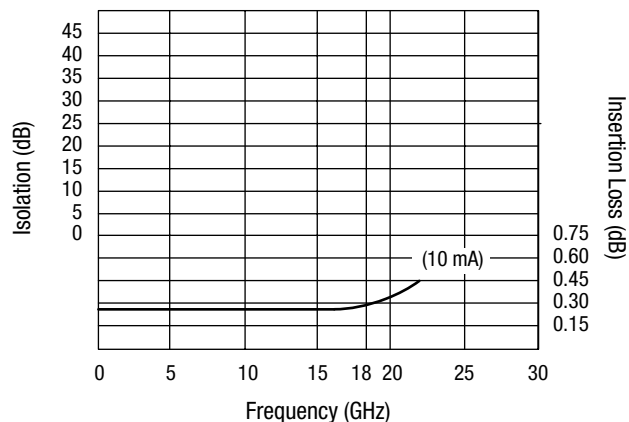

Typical Isolation and Insertion Loss Characteristics

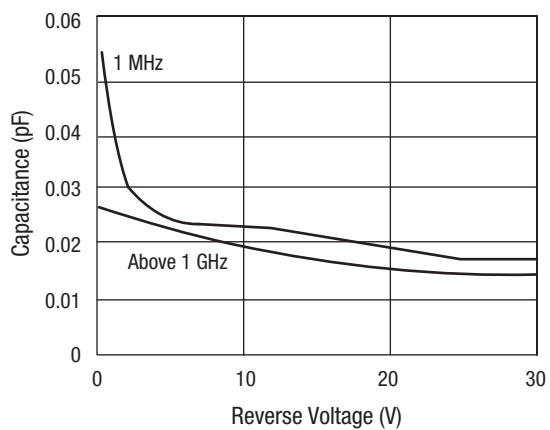

Typical Capacitance vs. Reverse Voltage

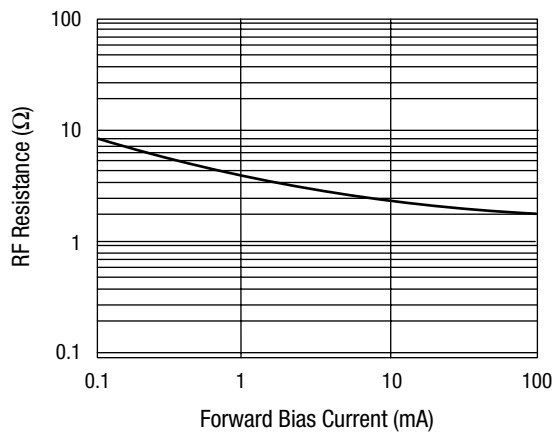

Typical RF Resistance vs. Forward Bias Current

### Typical SPDT Circuit Arrangement

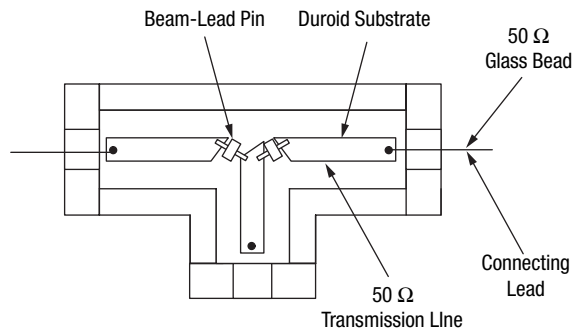

### Typical Beam-Lead Mounting

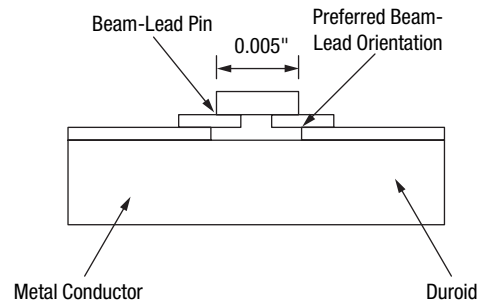

### 389-003

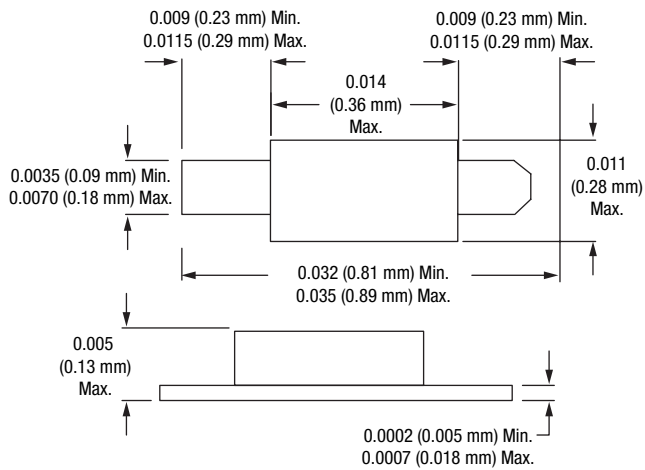

## Beam-Lead Diodes

### Handling

Due to their small size, beam-lead devices are fragile and should be handled with extreme care. The individual plastic packages should be handled and opened carefully, so that no undue mechanical strain is applied to the packaged device. It is recommended that the beam-lead devices be handled through use of a vacuum pencil using an appropriate size vacuum needle or a pointed wooden stick such as a sharpened Q-tip or match stick. The device will adhere to the point and can easily be removed from the container and positioned accurately for bonding without damage. Such handling should be done under a binocular microscope with magnification in the range of 20X to 30X.

Special handling precautions are also required to avoid electrical damage, such as static discharge.

### Bonding

The DSM8100-000 can best be bonded to substrates by means of thermocompression bonding. Essentially this type of bonding involves pressing the gold beam of the device against the gold-plated metalized substrate under proper conditions of heat and pressure so that a metallurgical bond joint between the two occurs.

### Procedure

The beam-lead devices to be bonded should be placed on a clean, hard surface such as a microscope slide. It is recommended that the beam side of the device be down so that this side will be toward the substrate when bonded. The device can be picked up by pressing lightly against one beam with the heated tip. The substrate can then be appropriately positioned under the tip and the device brought down against the substrate, with proper pressure applied by means of the weld head.

A bonding tip temperature in the 350 °C to 450 °C range is recommended along with a bonding force of 50 to 70 grams. The bonding time is in the range of 2 to 3 seconds. Optimum bonding conditions should be determined by trial and error to compensate for slight variations in the condition of the substrate, bonding tip, and the type of device being bonded.

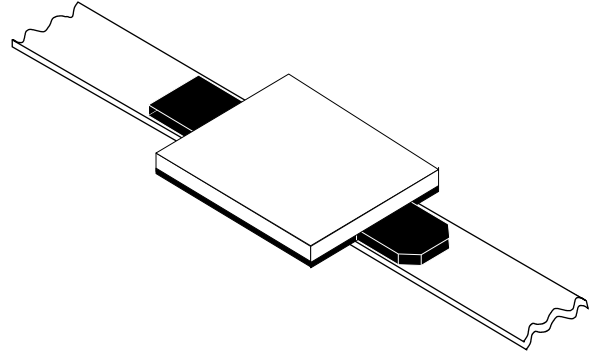

### Equipment

The heat and pressure are obtained through use of a silicon carbide bonding tip with a radius of two to three mils. Such an item is available from several commercial sources. In order to supply the required tip-travel and apply proper pressure, a standard miniature weld head can be used. Also available is a heated wedge shank which is held by the weld head and in turn holds the tip and supplies heat to it. The wedge shank is heated by means of a simple AC power supply or a pulse-type heated tool.

### Substrate

For optimum bonding, a gold-plated surface at least 100-microinches thick is necessary. Although it is possible to bond to relatively soft metalized substrate material such as epoxy-fiber-glass, etc., optimum bonding occurs when a hard material such as ceramic can be used.

### Quality

If a good bond has been obtained, it is impossible to separate the beam-lead device from the metalized substrate without damage. If the device is destructively removed, the beam will tear away, leaving the bonded portion attached to the substrate.

### Beam-Lead Packaging

The DSM8100-000 is shipped in 2" x 2" black gel packs. The beam-leads are mounted on the gel, and the devices are covered with a piece of lint-free release paper, on top of which is placed a piece of conductive foam.

Copyright © 2002, 2003, 2004, 2005, 2006, 2007, 2008, Skyworks Solutions, Inc. All Rights Reserved.

Information in this document is provided in connection with Skyworks Solutions, Inc. ("Skyworks") products or services. These materials, including the information contained herein, are provided by Skyworks as a service to its customers and may be used for informational purposes only by the customer. Skyworks assumes no responsibility for errors or omissions in these materials or the information contained herein. Skyworks may change its documentation, products, services, specifications or product descriptions at any time, without notice. Skyworks makes no commitment to update the materials or information and shall have no responsibility whatsoever for conflicts, incompatibilities, or other difficulties arising from any future changes.

No license, whether express, implied, by estoppel or otherwise, is granted to any intellectual property rights by this document. Skyworks assumes no liability for any materials, products or information provided hereunder, including the sale, distribution, reproduction or use of Skyworks products, information or materials, except as may be provided in Skyworks Terms and Conditions of Sale.

THE MATERIALS, PRODUCTS AND INFORMATION ARE PROVIDED "AS IS" WITHOUT WARRANTY OF ANY KIND, WHETHER EXPRESS, IMPLIED, STATUTORY, OR OTHERWISE, INCLUDING FITNESS FOR A PARTICULAR PURPOSE OR USE, MERCHANTABILITY, PERFORMANCE, QUALITY OR NON-INFRINGEMENT OF ANY INTELLECTUAL PROPERTY RIGHT; ALL SUCH WARRANTIES ARE HEREBY EXPRESSLY DISCLAIMED. SKYWORKS DOES NOT WARRANT THE ACCURACY OR COMPLETENESS OF THE INFORMATION, TEXT, GRAPHICS OR OTHER ITEMS CONTAINED WITHIN THESE MATERIALS. SKYWORKS SHALL NOT BE LIABLE FOR ANY DAMAGES, INCLUDING BUT NOT LIMITED TO ANY SPECIAL, INDIRECT, INCIDENTAL, STATUTORY, OR CONSEQUENTIAL DAMAGES, INCLUDING WITHOUT LIMITATION, LOST REVENUES OR LOST PROFITS THAT MAY RESULT FROM THE USE OF THE MATERIALS OR INFORMATION, WHETHER OR NOT THE RECIPIENT OF MATERIALS HAS BEEN ADVISED OF THE POSSIBILITY OF SUCH DAMAGE.

Skyworks products are not intended for use in medical, lifesaving or life-sustaining applications, or other equipment in which the failure of the Skyworks products could lead to personal injury, death, physical or environmental damage. Skyworks customers using or selling Skyworks products for use in such applications do so at their own risk and agree to fully indemnify Skyworks for any damages resulting from such improper use or sale.

Customers are responsible for their products and applications using Skyworks products, which may deviate from published specifications as a result of design defects, errors, or operation of products outside of published parameters or design specifications. Customers should include design and operating safeguards to minimize these and other risks. Skyworks assumes no liability for applications assistance, customer product design, or damage to any equipment resulting from the use of Skyworks products outside of stated published specifications or parameters.

Skyworks, the Skyworks symbol, and "Breakthrough Simplicity" are trademarks or registered trademarks of Skyworks Solutions, Inc., in the United States and other countries. Third-party brands and names are for identification purposes only, and are the property of their respective owners. Additional information, including relevant terms and conditions, posted at [www.skyworksinc.com](http://www.skyworksinc.com), are incorporated by reference.