

**DATA SHEET**

# SKY13277-355LF: GaAs SP3T Absorptive Switch 500 MHz–2.5 GHz

**Features**

- Positive voltage control (0/3 V typ.)
- High isolation 62 dB at 1 GHz
- Integrated silicon CMOS driver
- Isolated ports are absorptive
- Available lead (Pb)-free and RoHS-compliant MSL-1 @ 260°C per JEDEC J-STD-020

**Description**

The SKY13277-355LF is a pHEMT GaAs FET IC high isolation absorptive single-pole 3-throw switch packaged in a 20-lead exposed-pad plastic package for low-cost commercial applications. This switch controls signals from 500 MHz to 2.5 GHz. The switch is ideal for cellular base station switch matrices and other applications that require good RF impedance match independent of switch state.

The SKY13277-355LF comprises a pHEMT switch die and a Si CMOS controller die. The switch die contains integral terminating resistors that present an absorptive load to the external circuit when the switch path is in its isolation state. The controller die has three inputs: supply voltage ( $V_{DD}$ ) and two logic control bits that select the state of the pHEMT switch die. External DC block capacitors are required on all RF ports.

The SKY13277-355LF operates from -40 °C to 85 °C.

A populated evaluation board is available.

**NEW** Skyworks offers lead (Pb)-free, RoHS (Restriction of Hazardous Substances)-compliant packaging.



**Functional Diagram**

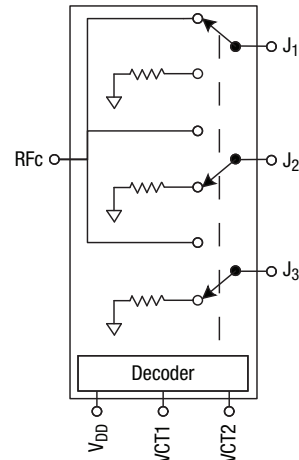

### Electrical Specifications at 25 °C

**V<sub>DD</sub> = 5 V, V<sub>CTL</sub> = 0/5 V, T = 25 C, P<sub>INPUT</sub> = 0 dBm, Z<sub>0</sub> = 50 Ω, unless otherwise noted**

Parameter	Frequency	Min.	Typ.	Max.	Unit
Insertion loss	0.5–1.0 GHz		0.9	1.1	dB
	1.0–2.0 GHz		1.1	1.3	dB
	2.0–2.5 GHz		1.3	1.5	dB
Isolation	0.5–1.0 GHz	60	62		dB
	1.0–2.0 GHz	53	57		dB
	2.0–2.5 GHz	49	55		dB
Return loss insertion loss state	0.5–1.0 GHz	11	15		dB
	1.0–2.0 GHz	9	12		dB
	2.0–2.5 GHz	8	11		dB
Return loss isolation state	0.5–1.0 GHz	11	15		dB
	1.0–2.0 GHz	10	14		dB
	2.0–2.5 GHz	8	13		dB

### Operating Characteristics at 25 °C

**V<sub>DD</sub> = 5 V, V<sub>CTL</sub> = 0/5 V, T = 25 C, P<sub>INPUT</sub> = 0 dBm, Z<sub>0</sub> = 50 Ω, unless otherwise noted**

Parameter	Condition	Frequency	Min.	Typ.	Max.	Unit
Switching characteristics						
Rise/fall time	10/90% or 90/10% RF			5		ns
On/off time	50% V <sub>CTL</sub> to 90/10% RF			15		ns
Input power for 1 dB compression	V <sub>DD</sub> = 5 V	0.5–2.5 GHz		30		dBm
Intermodulation Intercept Point (IP3)	For two tone input power 13 dBm/tone 1 MHz spacing, V <sub>DD</sub> = 5 V	0.5–2.5 GHz		43		dBm
Control voltages	V <sub>CTLLOW</sub>		0		0.5	V
	V <sub>CTLHIGH</sub>		2.4		V <sub>DD</sub>	V
Control port current	V <sub>CTLLOW</sub> , V <sub>CTLHIGH</sub>			5		μA
Supply voltage (V <sub>DD</sub> )			2.75		5.5	V
Supply current (I <sub>DD</sub> )	V <sub>DD</sub> = 3 V			50		μA

1. V<sub>DD</sub> must be powered on prior to a V<sub>CTL</sub> high signal. A latch up condition may occur if a logic high signal is applied prior to the V<sub>DD</sub> voltage.
2. Control voltages switch the V<sub>DD</sub> voltage to the GaAs switch.

### Typical Performance Data

$V_{DD} = 5\text{ V}$ ,  $V_{CTL} = 0/5\text{ V}$ ,  $T = 25\text{ C}$ ,  $P_{INPUT} = 0\text{ dBm}$ ,  $C_{BLOCK} = 47\text{ pF}$ ,  $Z_0 = 50\ \Omega$ , unless otherwise noted

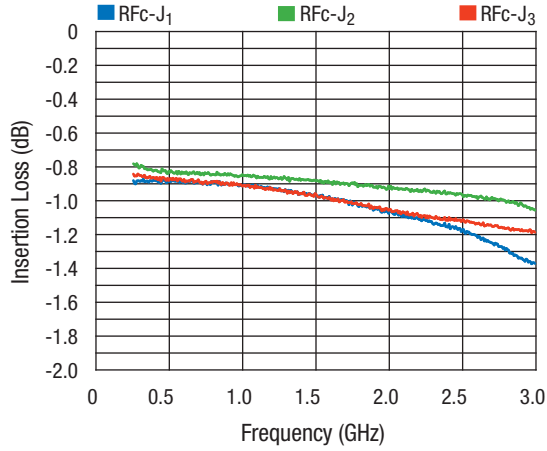

Typical Insertion Loss

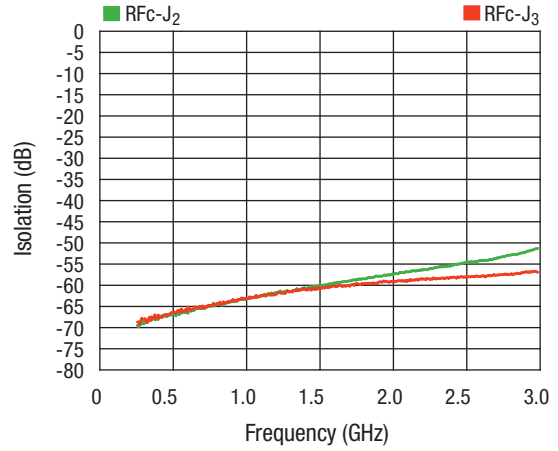

Typical Isolation RfC-J1 Ins. state

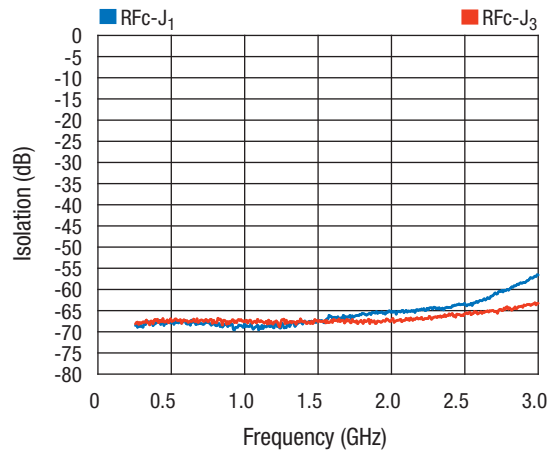

Typical Isolation RfC-J2 Ins. state

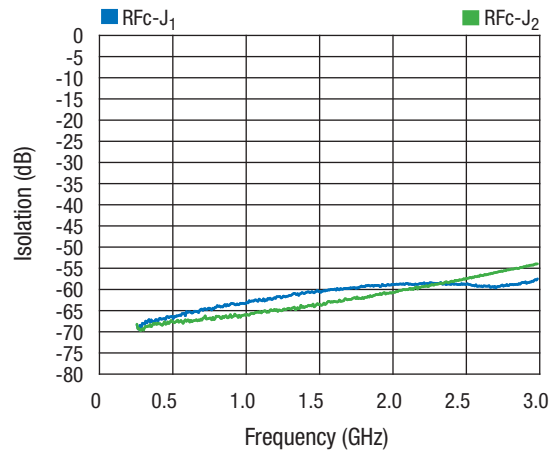

Typical Isolation RfC-J3 Ins. state

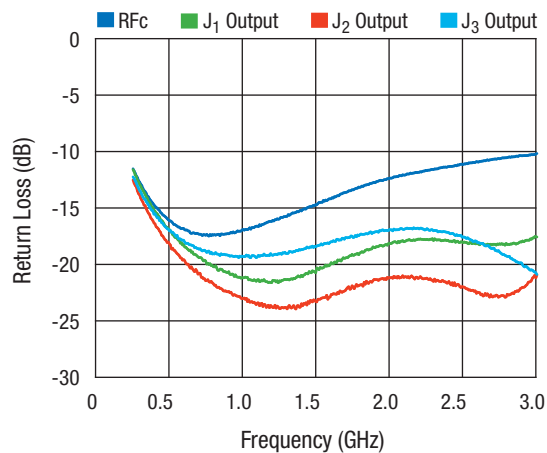

Typical Return Loss Ins. State

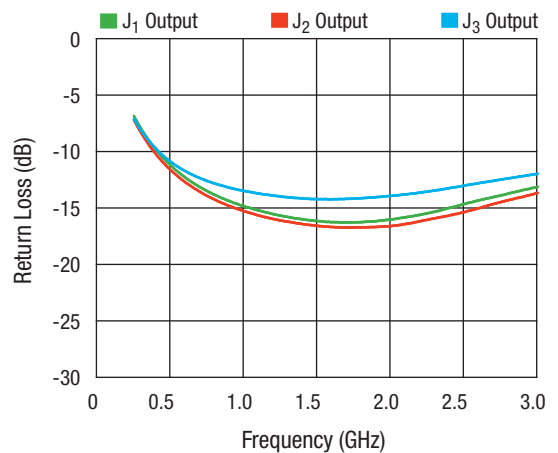

Typical Return Loss Isolation States

### Absolute Maximum Ratings

Characteristic	Value
RF input power @ 5.5 V	32 dBm, f > 500 MHz
V <sub>DD</sub> voltage range	2.75 ≤ V <sub>DD</sub> ≤ 5.5 V
Operating temperature	-40 °C to +85 °C
Storage temperature	-65 °C to +150 °C

Performance is guaranteed only under the conditions listed in the specifications table and is not guaranteed under the full range(s) described by the Absolute Maximum ratings. Exceeding any of the absolute maximum/minimum ratings may result in permanent damage to the device and will void the warranty.

**CAUTION:** Although this device is designed to be as robust as possible, ESD (Electrostatic Discharge) can damage this device. This device must be protected at all times from ESD. Static charges may easily produce potentials of several kilovolts on the human body or equipment, which can discharge without detection. Industry-standard ESD precautions must be employed at all times.

### Pin Out (Top View)

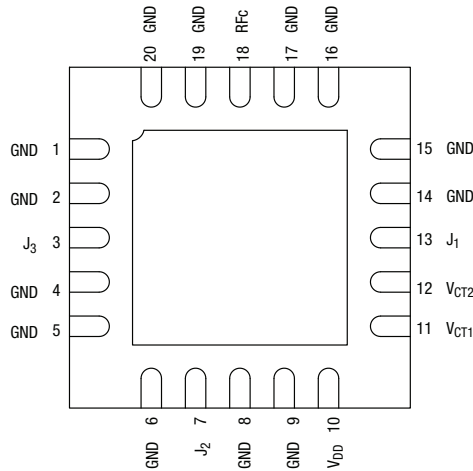

DC blocks are required on RFC, J<sub>1</sub>, J<sub>2</sub>, J<sub>3</sub>.

### Truth Table

VCT1	VCT2	RFC to J <sub>1</sub>	RFC to J <sub>2</sub>	RFC to J <sub>3</sub>
0	0	Insertion loss	Isolation	Isolation
1	0	Isolation	Insertion loss	Isolation
0	1	Isolation	Isolation	Insertion loss
1	1	Undefined	Undefined	Undefined

"0" = 0 to 0.5 V.  
 "1" = 2.4 to V<sub>DD</sub>.  
 V<sub>DD</sub> = 2.75 to 5.5 V.

### Recommended Solder Reflow Profiles

Refer to the ["Recommended Solder Reflow Profile"](#) Application Note.

### Tape and Reel Information

Refer to the ["Discrete Devices and IC Switch/Attenuators Tape and Reel Package Orientation"](#) Application Note.

### Pin Descriptions

Pin Number	Pin Name	Description
1, 2, 4, 5, 6, 8, 9, 14-17, 19, 20	Gnd	Ground
3	J <sub>3</sub>	RF port, must be DC blocked
7	J <sub>2</sub>	RF port, must be DC blocked
10	V <sub>DD</sub>	DC bias for decoder
11	V <sub>CT1</sub>	DC logic pin
12	V <sub>CT2</sub>	DC logic pin
13	J <sub>1</sub>	RF port, must be DC blocked
18	RFC	RF common port, must be DC blocked
Exposed Paddle	Paddle	Ground

**Evaluation Board**

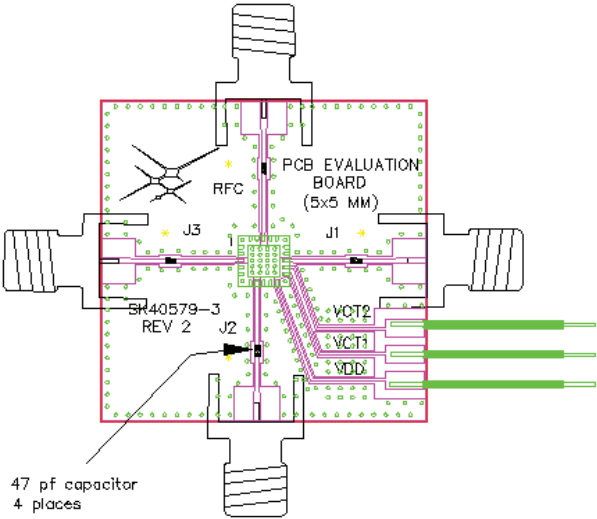

**Part Marking**

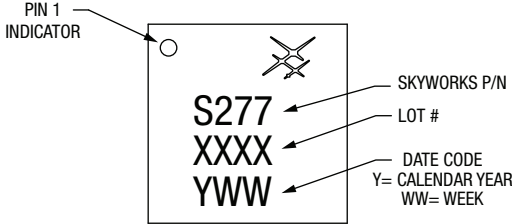

**QFN-20 (5 x 5 mm)**

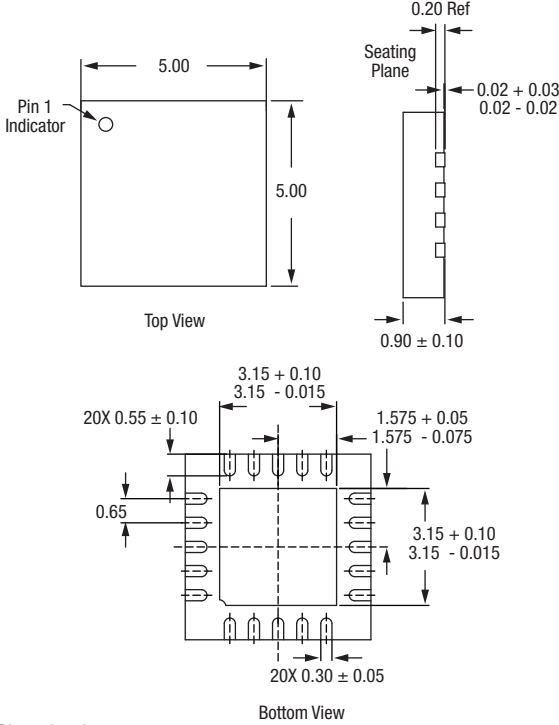

Copyright © 2002, 2003, 2004, 2005, 2006, 2007, 2008, Skyworks Solutions, Inc. All Rights Reserved.

Information in this document is provided in connection with Skyworks Solutions, Inc. ("Skyworks") products or services. These materials, including the information contained herein, are provided by Skyworks as a service to its customers and may be used for informational purposes only by the customer. Skyworks assumes no responsibility for errors or omissions in these materials or the information contained herein. Skyworks may change its documentation, products, services, specifications or product descriptions at any time, without notice. Skyworks makes no commitment to update the materials or information and shall have no responsibility whatsoever for conflicts, incompatibilities, or other difficulties arising from any future changes.

No license, whether express, implied, by estoppel or otherwise, is granted to any intellectual property rights by this document. Skyworks assumes no liability for any materials, products or information provided hereunder, including the sale, distribution, reproduction or use of Skyworks products, information or materials, except as may be provided in Skyworks Terms and Conditions of Sale.

THE MATERIALS, PRODUCTS AND INFORMATION ARE PROVIDED "AS IS" WITHOUT WARRANTY OF ANY KIND, WHETHER EXPRESS, IMPLIED, STATUTORY, OR OTHERWISE, INCLUDING FITNESS FOR A PARTICULAR PURPOSE OR USE, MERCHANTABILITY, PERFORMANCE, QUALITY OR NON-INFRINGEMENT OF ANY INTELLECTUAL PROPERTY RIGHT; ALL SUCH WARRANTIES ARE HEREBY EXPRESSLY DISCLAIMED. SKYWORKS DOES NOT WARRANT THE ACCURACY OR COMPLETENESS OF THE INFORMATION, TEXT, GRAPHICS OR OTHER ITEMS CONTAINED WITHIN THESE MATERIALS. SKYWORKS SHALL NOT BE LIABLE FOR ANY DAMAGES, INCLUDING BUT NOT LIMITED TO ANY SPECIAL, INDIRECT, INCIDENTAL, STATUTORY, OR CONSEQUENTIAL DAMAGES, INCLUDING WITHOUT LIMITATION, LOST REVENUES OR LOST PROFITS THAT MAY RESULT FROM THE USE OF THE MATERIALS OR INFORMATION, WHETHER OR NOT THE RECIPIENT OF MATERIALS HAS BEEN ADVISED OF THE POSSIBILITY OF SUCH DAMAGE.

Skyworks products are not intended for use in medical, lifesaving or life-sustaining applications, or other equipment in which the failure of the Skyworks products could lead to personal injury, death, physical or environmental damage. Skyworks customers using or selling Skyworks products for use in such applications do so at their own risk and agree to fully indemnify Skyworks for any damages resulting from such improper use or sale.

Customers are responsible for their products and applications using Skyworks products, which may deviate from published specifications as a result of design defects, errors, or operation of products outside of published parameters or design specifications. Customers should include design and operating safeguards to minimize these and other risks. Skyworks assumes no liability for applications assistance, customer product design, or damage to any equipment resulting from the use of Skyworks products outside of stated published specifications or parameters.

Skyworks, the Skyworks symbol, and "Breakthrough Simplicity" are trademarks or registered trademarks of Skyworks Solutions, Inc., in the United States and other countries. Third-party brands and names are for identification purposes only, and are the property of their respective owners. Additional information, including relevant terms and conditions, posted at [www.skyworksinc.com](http://www.skyworksinc.com), are incorporated by reference.