

DATA SHEET

SKY13278-313LF: GaAs SPDT Switch 100 MHz–2.5 GHz

Features

- Broadband: 100 MHz–2.5 GHz
- Very low insertion loss: 0.4 dB typ. @ 900 MHz
- High isolation: 26 dB typ. @ 900 MHz
- Low current consumption: <100 μ A @ 3 V
- Miniature QFN-6 2 x 3 mm package
- Lead (Pb)-free and RoHS-compliant MSL-1 @ 260 °C per JEDEC J-STD-020

Description

The SKY13278-313LF is a pHEMT GaAs FET IC high linearity SPDT switch. This wideband switch has been designed for use from 100 MHz to 2.5 GHz, where extremely high linearity, low control voltage, high isolation, low insertion loss and ultra-miniature package size are required. It can be controlled with positive, negative or a combination of both voltages. The RF signal paths within the SKY13278-313LF are fully bilateral.

Some standard implementations include T/R switching and diversity switching over 3 W. The SKY13278-313LF switch can be used in many analog and digital wireless communication systems including cellular, GSM and UMTS applications.

Switching is controlled via two control voltage inputs. Depending upon the voltage level applied to the control voltage pins, the

Function Block Diagram

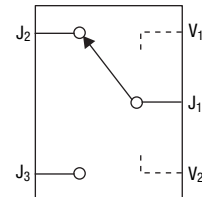

common RF port (J_1) is connected to one of two RF ports (J_2 or J_3) via a low insertion loss path, while the path between J_1 and the other RF port is in its isolation state. When the control voltages are toggled, the states between J_1 and J_2 , as well as J_1 and J_3 , are also toggled.

The SKY13278-313LF is available in a lead(Pb)-free, RoHS-compliant, QFN-6 2 x 3 mm plastic package.

An evaluation board is available upon request.



Skyworks offers lead (Pb)-free, RoHS (Restriction of Hazardous Substances)-compliant packaging.

Electrical Specifications

$V_{CTL} = 0/3$ V, $T = 25$ °C, $P_{INPUT} = 0$ dBm, $Z_0 = 50$ Ω unless otherwise noted

Parameter	Frequency	Min.	Typ.	Max.	Unit
Insertion loss	0.1–0.5 GHz		0.40	0.5	dB
	0.5–1.0 GHz		0.40	0.5	dB
	1.0–2.0 GHz		0.45	0.6	dB
	2.0–2.5 GHz		0.55	0.7	dB
Isolation	0.1–0.5 GHz	29	32		dB
	0.5–1.0 GHz	23	26		dB
	1.0–2.0 GHz	17	20		dB
	2.0–2.5 GHz	15	18		dB
Return loss (insertion loss state) Lower frequency return loss is dependent on DC blocks	0.1–0.5 GHz		20		dB
	1.0–2.0 GHz		20		dB

Operating Characteristics

$V_{CTL} = 0/3\text{ V}$, $T = 25\text{ }^\circ\text{C}$, $P_{INPUT} = 0\text{ dBm}$, $Z_0 = 50\text{ }\Omega$ unless otherwise noted

Parameter	Condition	Frequency	Min.	Typ.	Max.	Unit
Switching characteristics						
Rise, fall	10/90% or 90/10% RF			650		ns
On, off	50% CTL to 90/10% RF			800		ns
Input power for 0.1 dB compression		900 MHz		40		dBm
Second, third harmonics	$P_{IN} = 34.5\text{ dBm}$, $f_{IN} = 900\text{ MHz}$			-75		dBc
Second, third harmonics	$P_{IN} = 32\text{ dBm}$, $f_{IN} = 1800\text{ MHz}$			-70		dBc
Blocker performance	$T_1 = 1950\text{ MHz @ } 20\text{ dBm}$ $T_2 = 1760\text{ MHz @ } -15\text{ dBm}$ IMD3 measured at 2140 MHz			-105		dBm
Thermal resistance				45		$^\circ\text{C/W}$
Control voltages	$V_{LOW} = 0\text{ V @ } 20\text{ }\mu\text{A maximum}$ $V_{HIGH} = 2.8\text{ V @ } 100\text{ }\mu\text{A maximum to } 5\text{ V @ } 200\text{ }\mu\text{A maximum}$					

Typical Performance Data

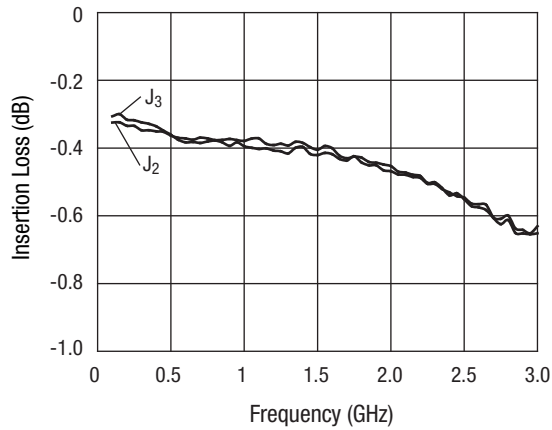

Insertion Loss vs. Frequency

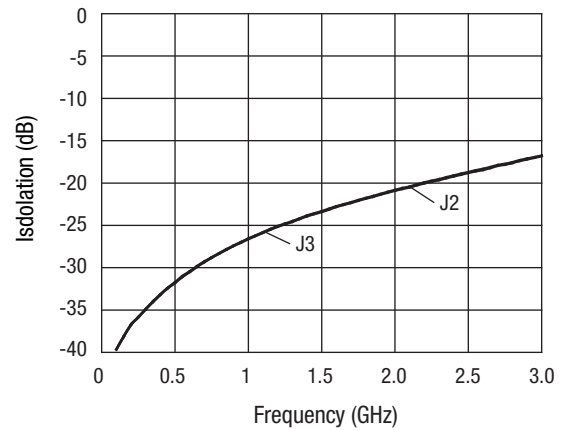

Isolation vs. Frequency

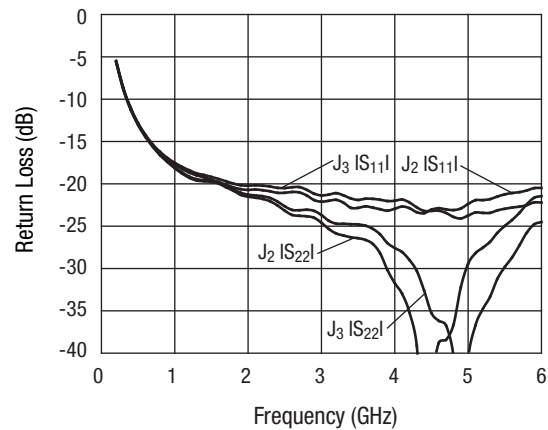

Return Loss vs. Frequency

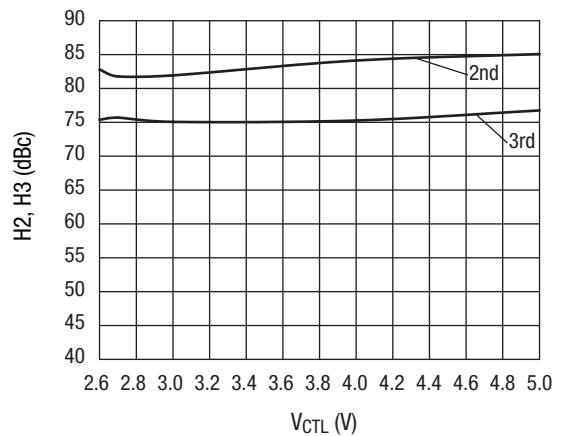

Second and Third Harmonics vs. Control Voltage
 $F_{IN} = 900\text{ MHz}$ $P_{IN} = 34.5\text{ dBm}$

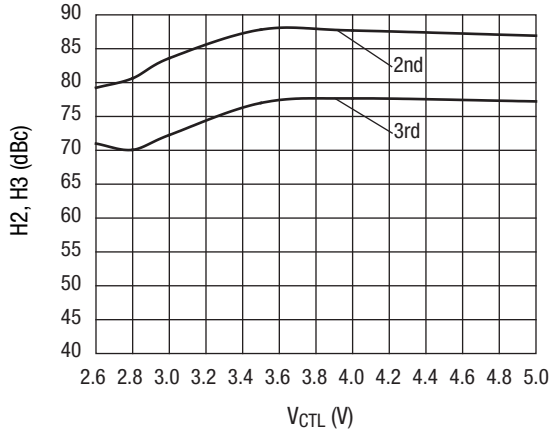

Second and Third Harmonics vs. Control Voltage
 $F_{IN} = 1800 \text{ MHz}$ $P_{IN} = 32 \text{ dBm}$

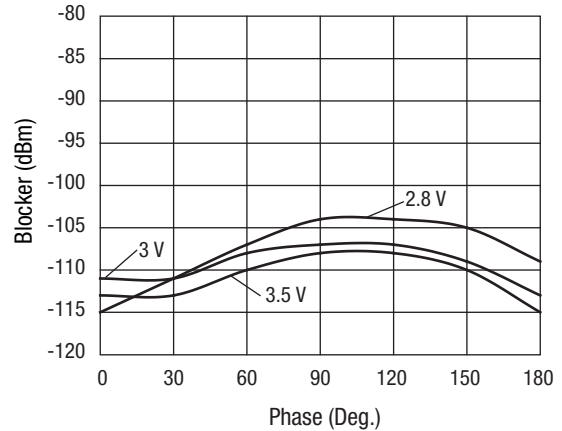

Blocker Performance vs. Phase
 $f_1 = 1950 \text{ MHz}$, $P_{IN} = +20 \text{ dBm}$
 $f_2 = 1760 \text{ MHz}$, $P_{IN} = -15 \text{ dBm}$
 Blocker Measured at 2140 MHz

Truth Table

V ₁	V ₂	J ₁ -J ₂	J ₁ -J ₃
V _{LOW}	V _{HIGH}	Isolation	Insertion loss
V _{HIGH}	V _{LOW}	Insertion loss	Isolation
V _{LOW}	V _{LOW}	Not recommended ⁽¹⁾	
V _{HIGH}	V _{HIGH}	Not recommended ⁽¹⁾	

2.8 V ≤ V_{HIGH} ≤ 5 V, 0 ≤ V_{LOW} ≤ 0.2 V.
 1. Switch is in an undefined state.

Recommended Solder Reflow Profiles

Refer to the [“Recommended Solder Reflow Profile”](#) Application Note.

Tape and Reel Information

Refer to the [“Discrete Devices and IC Switch/Attenuators Tape and Reel Package Orientation”](#) Application Note.

Absolute Maximum Ratings

Characteristic	Value
RF input power @ 5 V	10 W, f > 900 MHz @ 25 °C
Control voltage	-0.2 ≤ V ₁ , V ₂ ≤ 8 V
Operating temperature	-40 °C to +85 °C
Storage temperature	-65 °C to +150 °C

Performance is guaranteed only under the conditions listed in the specifications table and is not guaranteed under the full range(s) described by the Absolute Maximum specifications. Exceeding any of the absolute maximum/minimum specifications may result in permanent damage to the device and will void the warranty.

CAUTION: Although this device is designed to be as robust as possible, ESD (Electrostatic Discharge) can damage this device. This device must be protected at all times from ESD. Static charges may easily produce potentials of several kilovolts on the human body or equipment, which can discharge without detection. Industry-standard ESD precautions must be employed at all times.

Pin Out

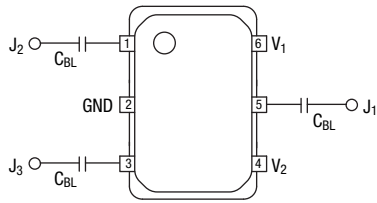

QFN-6

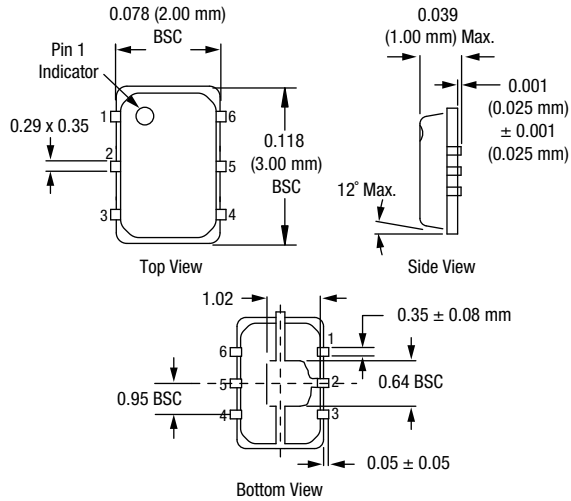

Pin Descriptions

Pin Number	Pin Name	Description
1	J ₂	RF Input/Output – RF input/output port which is either connected to J ₁ via a low insertion loss path or isolated from J ₁ , according to the logic voltage levels applied to V ₁ and V ₂ .
2	GND	Equipotential Point – Internal circuit common, which must be connected to the pcb ground or common via the lowest possible impedance.
3	J ₃	RF Input/Output – RF input/output port which is either connected to J ₁ via a low insertion loss path or isolated from J ₁ , according to the logic voltage levels applied to V ₁ and V ₂ .
4	V ₂	Control Voltage 2 – Control voltage input #2. The logic voltage level applied to this pin, along with the voltage level applied to V ₁ (pin 6), determines the states of the RF paths between J ₁ –J ₂ and J ₁ –J ₃ .
5	J ₁	RF Common Input/Output – RF common input/output port which is either connected to J ₂ or to J ₃ via a low insertion loss and isolated from the other RF port, according to the logic voltage levels applied to V ₁ and V ₂ .
6	V ₁	Control Voltage 1 – Control voltage input #1. The logic voltage level applied to this pin, along with the voltage level applied to V ₂ (pin 4), determines the states of the RF paths between J ₁ –J ₂ and J ₁ –J ₃ .

Evaluation Board

The evaluation board for the SKY13278-313 allows the switch to be fully exercised. The RF common port is marked “J₁”, and the two switched RF ports are marked “J₂” and “J₃”. All of the RF ports have SMA connectors mounted. The control voltage inputs are marked “V₁” and “V₂”.

The printed circuit board material is FR4. The RF dielectric layer is 0.012 inches thick, ½ oz. copper. The RF transmission lines are each 50 Ω (nominal) microstrip.

There are three DC blocking capacitors on the board, C₁, C₂ and C₃, each of which is in series with one of the RF ports. These capacitors are 47 pF. For improved insertion loss at signal frequencies below approximately 500 MHz these capacitors should be replaced with larger capacitance capacitors, such as 1000 pF.

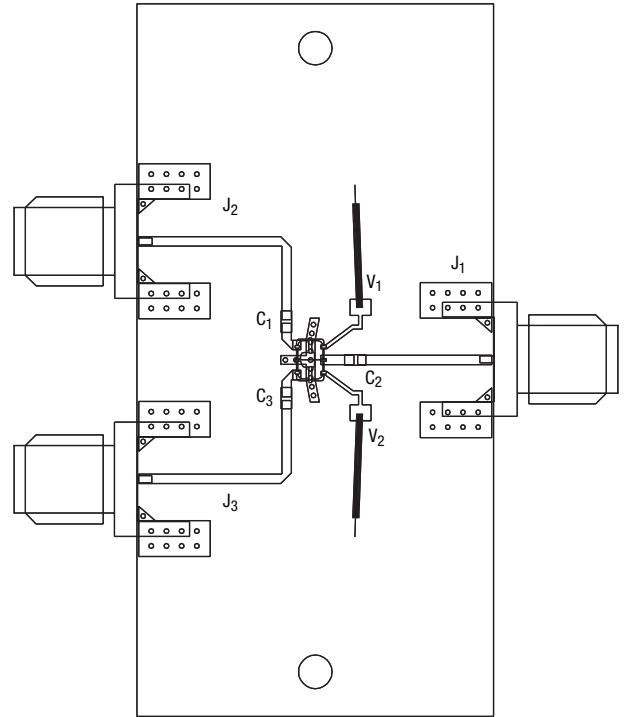

Item	Description	Comments
C ₁ , C ₂ , C ₃	DC Blocking Capacitor, 47 pF	0402
J ₁ , J ₂ , J ₃	SMA Connector, Edge Mount	
U1	SKY13278-313	
Printed Circuit Board	Skyworks SK39990	

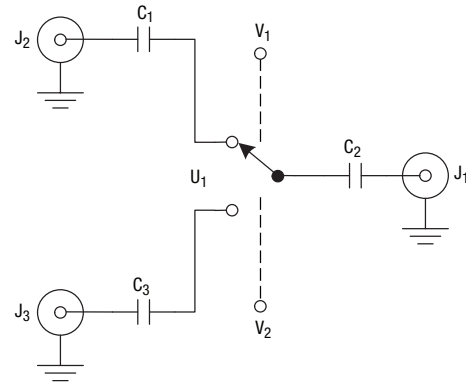

Copyright © 2002, 2003, 2004, 2005, 2006, 2007, Skyworks Solutions, Inc. All Rights Reserved.

Information in this document is provided in connection with Skyworks Solutions, Inc. ("Skyworks") products or services. These materials, including the information contained herein, are provided by Skyworks as a service to its customers and may be used for informational purposes only by the customer. Skyworks assumes no responsibility for errors or omissions in these materials or the information contained herein. Skyworks may change its documentation, products, services, specifications or product descriptions at any time, without notice. Skyworks makes no commitment to update the materials or information and shall have no responsibility whatsoever for conflicts, incompatibilities, or other difficulties arising from any future changes.

No license, whether express, implied, by estoppel or otherwise, is granted to any intellectual property rights by this document. Skyworks assumes no liability for any materials, products or information provided hereunder, including the sale, distribution, reproduction or use of Skyworks products, information or materials, except as may be provided in Skyworks Terms and Conditions of Sale.

THE MATERIALS, PRODUCTS AND INFORMATION ARE PROVIDED "AS IS" WITHOUT WARRANTY OF ANY KIND, WHETHER EXPRESS, IMPLIED, STATUTORY, OR OTHERWISE, INCLUDING FITNESS FOR A PARTICULAR PURPOSE OR USE, MERCHANTABILITY, PERFORMANCE, QUALITY OR NON-INFRINGEMENT OF ANY INTELLECTUAL PROPERTY RIGHT; ALL SUCH WARRANTIES ARE HEREBY EXPRESSLY DISCLAIMED. SKYWORKS DOES NOT WARRANT THE ACCURACY OR COMPLETENESS OF THE INFORMATION, TEXT, GRAPHICS OR OTHER ITEMS CONTAINED WITHIN THESE MATERIALS. SKYWORKS SHALL NOT BE LIABLE FOR ANY DAMAGES, INCLUDING BUT NOT LIMITED TO ANY SPECIAL, INDIRECT, INCIDENTAL, STATUTORY, OR CONSEQUENTIAL DAMAGES, INCLUDING WITHOUT LIMITATION, LOST REVENUES OR LOST PROFITS THAT MAY RESULT FROM THE USE OF THE MATERIALS OR INFORMATION, WHETHER OR NOT THE RECIPIENT OF MATERIALS HAS BEEN ADVISED OF THE POSSIBILITY OF SUCH DAMAGE.

Skyworks products are not intended for use in medical, lifesaving or life-sustaining applications, or other equipment in which the failure of the Skyworks products could lead to personal injury, death, physical or environmental damage. Skyworks customers using or selling Skyworks products for use in such applications do so at their own risk and agree to fully indemnify Skyworks for any damages resulting from such improper use or sale.

Customers are responsible for their products and applications using Skyworks products, which may deviate from published specifications as a result of design defects, errors, or operation of products outside of published parameters or design specifications. Customers should include design and operating safeguards to minimize these and other risks. Skyworks assumes no liability for applications assistance, customer product design, or damage to any equipment resulting from the use of Skyworks products outside of stated published specifications or parameters.

Skyworks, the Skyworks symbol, and "Breakthrough Simplicity" are trademarks or registered trademarks of Skyworks Solutions, Inc., in the United States and other countries. Third-party brands and names are for identification purposes only, and are the property of their respective owners. Additional information, including relevant terms and conditions, posted at www.skyworksinc.com, are incorporated by reference.