

**DATA SHEET**

# SKY65048-360LF: 0.7-1.2 GHz Low Noise Amplifier

## Applications

- Wireless infrastructure: GSM, CDMA, WCDMA, ISM, and TD-SCDMA
- Ultra-low noise applications

## Features

- Ultra-low Noise Figure = 0.65 dB @ 900 MHz
- Excellent input and output return loss
- Adjustable gain = 16.5 to 21.5 dB @ 900 MHz
- High output OIP3 = +35.5 dBm @ 85 mA
- OP1dB = +18.5 dBm @ 900 MHz
- Single, positive DC supply voltage
- Adjustable supply current, 30 to 100 mA
- Small, QFN (8-pin, 2 x 2 mm) package (MSL1, 260 °C per JEDEC J-STD-020)

**NEW**



Skyworks Green™ products are RoHS (Restriction of Hazardous Substances)-compliant, conform to the EIA/EICTA/JEITA Joint Industry Guide (JIG) Level A guidelines, are halogen free according to IEC-61249-2-21, and contain <1,000 ppm antimony trioxide in polymeric materials.

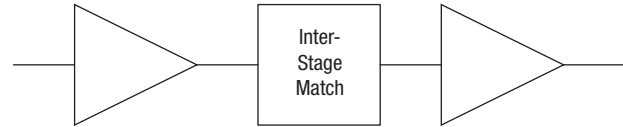

**Figure 1. SKY65048-360LF Block Diagram**

## Description

The SKY65048-360LF is a high performance, two-stage ultra-low noise amplifier. The device is fabricated from Skyworks advanced pHEMT process and is provided in a 2 x 2 mm, 8-pin Quad Flat No-Lead (QFN) package.

The device features excellent input and output return loss, an integrated interstage matching network, and integrated source inductors for 1<sup>st</sup> and 2<sup>nd</sup> stage transistors. The amplifier's ultra-low Noise Figure (NF), high gain, and excellent 3<sup>rd</sup> Order Intercept point (IP3) allow it to be used in various receiver and transmitter applications.

A functional block diagram is shown in Figure 1. The pin configuration and package are shown in Figure 2. Signal pin assignments and functional pin descriptions are provided in Table 1.

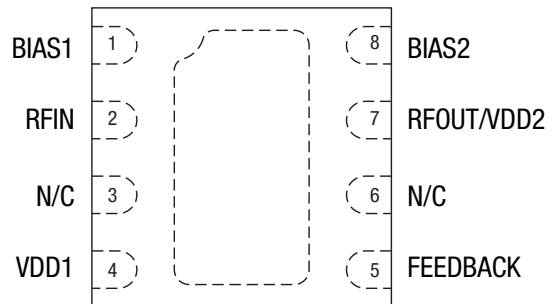

**Figure 2. SKY65048-360LF Pinout – 8-Pin QFN (Top View)**

**Table 1. SKY65048-360LF Signal Descriptions**

Pin #	Name	Description	Pin #	Name	Description
1	BIAS1	Source lead for 1 <sup>st</sup> stage transistor	5	FEEDBACK	Connect to RFOUT/VDD2 to reduce gain of 2 <sup>nd</sup> stage transistor
2	RFIN	RF input	6	N/C	No connection
3	N/C	No connection	7	RFOUT/VDD2	RF output. Requires a DC bias using an RF choke inductor.
4	VDD1	1 <sup>st</sup> stage DC power supply	8	BIAS2	Source lead for 2 <sup>nd</sup> stage transistor

### Functional Description

The SKY65048-360LF is a two stage, low noise amplifier with an integrated interstage matching network and source inductors. The device has a tested low NF of 0.65 dB and gain of 16.5 dB with the recommended matching circuit. The device allows designers to adjust current and gain without degrading the NF.

The external matching network largely dictates the RF performance of the device. The matching network is required for operation and special care should be taken when designing a circuit board layout for the SKY65048-360LF. There are four separate groups of external components: input, output, biasing, and feedback.

### Biasing

To properly bias a depletion mode pHEMT, both the gate and drain of the device must be biased properly. At  $V_{GS} = 0\text{ V}$  and  $V_{DS} > 2\text{ V}$ , the amplifier stage is in its saturated state and draws the maximum amount of current,  $I_{DSS}$ . A  $V_{DS}$  of 5 V is recommended to ensure proper performance.

To eliminate the need for a negative DC supply, self-biasing should be used when a resistor is placed between one of the source leads and ground. A bypass capacitor should be placed in parallel to this resistor to provide an RF ground and to ensure performance remains unchanged at the operating frequency.

When current flows from drain to source and through the resistor, the source voltage becomes biased above DC ground. The gate pin of the device should be left unbiased at 0 V, which creates the desired negative  $V_{GS}$  value. This simplifies the design by eliminating the need for a second DC supply. Values for resistor components R1 and R2 can be changed to easily increase or decrease the bias current to a desired level.

The first stage is biased at 20 percent of  $I_{DSS}$  to achieve the best NF performance. The gain and current of the 2<sup>nd</sup> stage amplifier can be adjusted without degrading the overall NF. More current in the 2<sup>nd</sup> stage yields better IP3 performance.

Biasing components R1, R2, C1, and C2 should be placed as close to the package pins as possible. See Figure 30 for the recommended board layout.

### Source Inductance

The source inductance required on pins 1 and 8 (BIAS1 and BIAS2 signals, respectively) has been integrated on the die. This simplifies board layout and reduces build variations.

### Input and Output RF Matching Network

The input band-pass matching network consists of four components. Component C1 serves as the input DC blocking capacitor, C2 provides high frequency stability and improved input return loss, and L1 and L2 are responsible for the best noise match looking into the gate of the first stage amplifier.

Excess board trace should be eliminated at the input of the device to minimize board losses. High-Q components should be used to achieve the best NF of the amplifier. Murata GJM series capacitors and Coilcraft HP or CS series inductors are recommended. Any excess board or component loss on the input of the device directly adds to the total measured NF.

The output matching network is band-pass network optimized for output return loss.

The SKY65048-360LF Evaluation Board assembly diagram is shown in Figure 31 and a circuit schematic is provided in Figure 32.

### Feedback

Feedback is implemented in the recommended circuit on the 2<sup>nd</sup> stage transistor. Feedback improves the input and output return loss and high frequency stability. The gain of the device can be increased by increasing the value of R3, which reduces the amount of feedback present (gain for multiple feedback resistor values is shown in Figure 30).

## Measuring NF

Special care should be taken when making < 1 dB NF measurements. Ideally, measurements should be made in an RF shield room. An Agilent MXA N9020A spectrum analyzer with an internal pre-amp paired with an N4001A smart noise source was used for all noise measurements. The smart noise source has an internal thermocouple that automatically sets the T<sub>COLD</sub> setting on the analyzer. If a smart noise source is unavailable, a standard low Excess Noise Ratio (ENR) source should be used. Use an external thermocouple to manually adjust the T<sub>COLD</sub> setting to ensure accurate results.

## Electrical and Mechanical Specifications

The absolute maximum ratings of the SKY65048-360LF are provided in Table 2. The recommended operating conditions are specified in Table 3 and electrical specifications are provided in Table 4.

Performance characteristics for the SKY65048-360LF are illustrated in Figures 3 through 30.

**Table 2. SKY65048-360LF Absolute Maximum Ratings**

Parameter	Symbol	Minimum	Typical	Maximum	Units
Supply voltage	V <sub>DD</sub>		5.5		V
Input power	P <sub>IN</sub>		+15		dBm
Supply current stage one	I <sub>DS1</sub>		100		mA
Supply current stage two	I <sub>DS2</sub>		100		mA
Power dissipation	P <sub>DIS</sub>		665		mW
Channel temperature	T <sub>J</sub>		150		°C
Storage temperature	T <sub>STG</sub>	-65		+125	°C
Operating temperature	T <sub>OP</sub>	-40		+85	°C
Thermal resistance	Q <sub>JC</sub>		47		°C/W

**Note:** Exposure to maximum rating conditions for extended periods may reduce device reliability. There is no damage to device with only one parameter set at the limit and all other parameters set at or below their nominal value.

**CAUTION:** Although this device is designed to be as robust as possible, Electrostatic Discharge (ESD) can damage this device. This device must be protected at all times from ESD. Static charges may easily produce potentials of several kilovolts on the human body or equipment, which can discharge without detection. Industry-standard ESD precautions should be used at all times.

**Table 3. SKY65048-360LF Recommended Operating Conditions**

Parameter	Symbol	Minimum	Typical	Maximum	Units
Supply voltage	V <sub>DD</sub>	4.75	5.00	5.25	V
Supply current	I <sub>DD</sub>	30	85	100	mA

**Table 4. SKY65048-360LF Electrical Specifications (Note 1)**  
**(T<sub>OP</sub> = +25 °C, Characteristic Impedance [Z<sub>0</sub>] = 50 Ω, V<sub>DD</sub> = 5 V, I<sub>DD</sub> = 85 mA, Unless Otherwise Noted)**

Parameter	Symbol	Test Condition	Min	Typical	Max	Units
<b><i>f = 787 MHz Using an 777 to 798 MHz Matching Network</i></b>						
Noise Figure (Note 2)	NF			0.65		dB
Small signal gain	IS21I			16.5		dB
Input return loss	IS11I			-20		dB
Output return loss	IS22I			-7		dB
Reverse isolation	IS12I			-32		dB
3 <sup>rd</sup> Order Output Intercept Point	OIP3	5 MHz spacing, P <sub>IN</sub> = -18 dBm per tone		+34		dBm
1 dB Output Compression Point	OP1dB			+18		dBm
3 <sup>rd</sup> Order Input Intercept Point	IIP3	5 MHz spacing, P <sub>IN</sub> = -18 dBm per tone		+17.5		dBm
1 dB Input Compression Point	IP1dB			+2.5		dBm
Stability		Unconditionally stable up to 18 GHz		>1		K
<b><i>f = 836 MHz Using an 824 to 849 MHz Matching Network</i></b>						
Noise Figure (Note 2)	NF			0.65		dB
Small signal gain	IS21I			17.5		dB
Input return loss	IS11I			-18		dB
Output return loss	IS22I			-6		dB
Reverse isolation	IS12I			-31		dB
3 <sup>rd</sup> Order Output Intercept Point	OIP3	5 MHz spacing, P <sub>IN</sub> = -18 dBm per tone		+36.5		dBm
1 dB Output Compression Point	OP1dB			+18		dBm
3 <sup>rd</sup> Order Input Intercept Point	IIP3	5 MHz spacing, P <sub>IN</sub> = -18 dBm per tone		+19		dBm
1 dB Input Compression Point	IP1dB			+1.5		dBm
Stability		Unconditionally stable up to 18 GHz		>1		K
<b><i>f = 900 MHz Using an 880 to 915 MHz Matching Network</i></b>						
Noise Figure (Note 2)	NF			0.65	0.85	dB
Small signal gain	IS21I		15.5	16.5	17.5	dB
Input return loss	IS11I			-18		dB
Output return loss	IS22I			-10		dB
Reverse isolation	IS12I			-30		dB
3 <sup>rd</sup> Order Output Intercept Point	OIP3	5 MHz spacing, P <sub>IN</sub> = -18 dBm per tone		+35		dBm
1 dB Output Compression Point	OP1dB			+18		dBm
3 <sup>rd</sup> Order Input Intercept Point	IIP3	5 MHz spacing, P <sub>IN</sub> = -18 dBm per tone		+18.5		dBm
1 dB Input Compression Point	IP1dB			+2.5		dBm
Stability		Unconditionally stable up to 18 GHz		>1		K

**Note 1:** Performance is guaranteed only under the conditions listed in this Table and is not guaranteed over the full operating or storage temperature ranges. Exceeding any of the conditions listed here may result in permanent damage to the device. Operation at elevated temperatures may reduce reliability of the device.

**Note 2:** Loss from input RF connector and board trace de-embedded from measurement.

### Typical Performance Characteristics

( $T_{OP} = +25\text{ }^{\circ}\text{C}$ , Characteristic Impedance [ $Z_0$ ] =  $50\ \Omega$ ,  $V_{DD} = 5\ \text{V}$ ,  $I_{DD} = 85\ \text{mA}$ , Parameters Include a Recommended 777-798 MHz Matching Network, Unless Otherwise Noted)

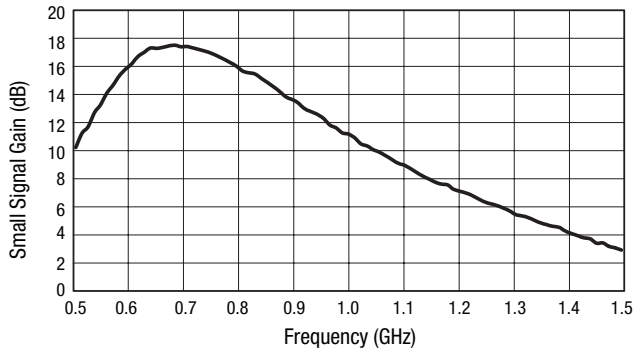

**Figure 3. Small Signal Gain vs Frequency @ 25 °C**  
( $P_{IN} = -20\ \text{dBm}$ )

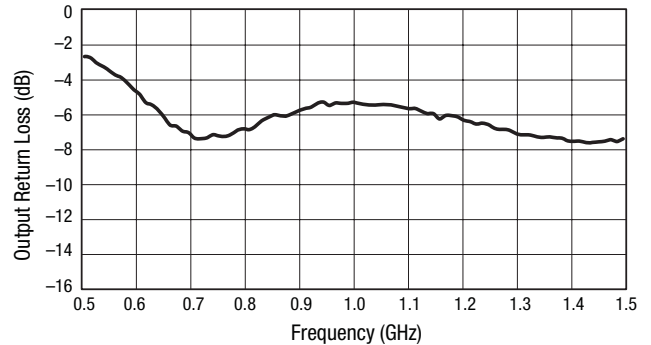

**Figure 4. Output Return Loss vs Frequency @ 25 °C**  
 $P_{IN} = -20\ \text{dBm}$

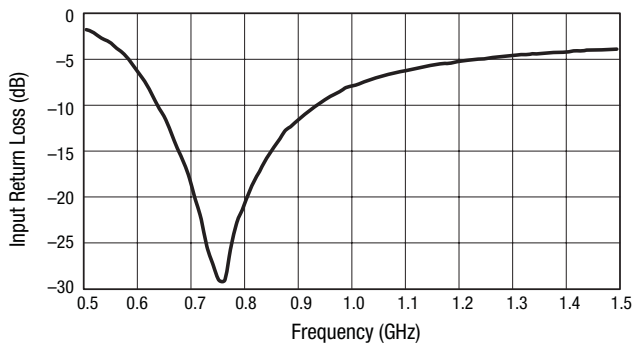

**Figure 5. Input Return Loss vs Frequency @ 25 °C**  
( $P_{IN} = -20\ \text{dBm}$ )

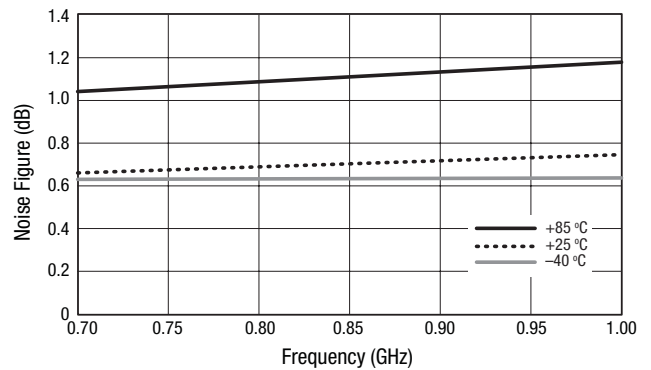

**Figure 6. Noise Figure vs Frequency Over Temperature**

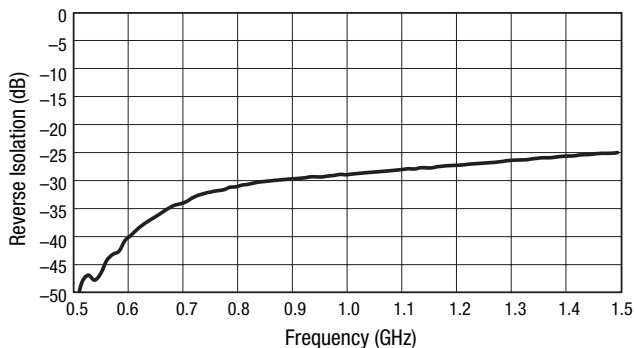

**Figure 7. Reverse Isolation vs Frequency @ 25 °C**  
( $P_{IN} = -20\ \text{dBm}$ )

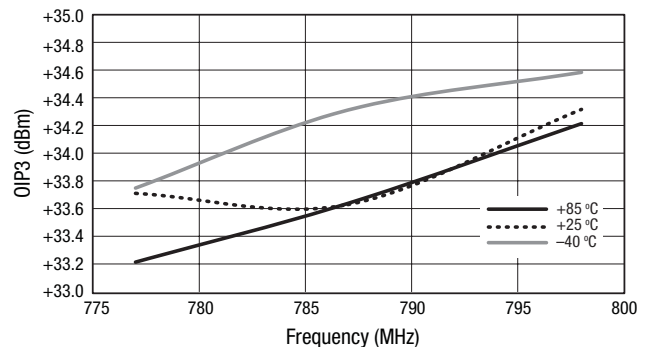

**Figure 8. OIP3 vs Frequency Over Temperature**  
( $P_{IN} = -18\ \text{dBm/Tone}$ , 5 MHz Tone Spacing)

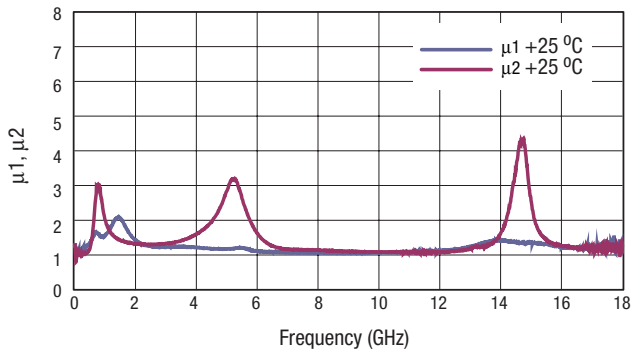

Figure 9. Stability vs Frequency @ 25 °C  
( $P_{IN} = -20$  dBm)

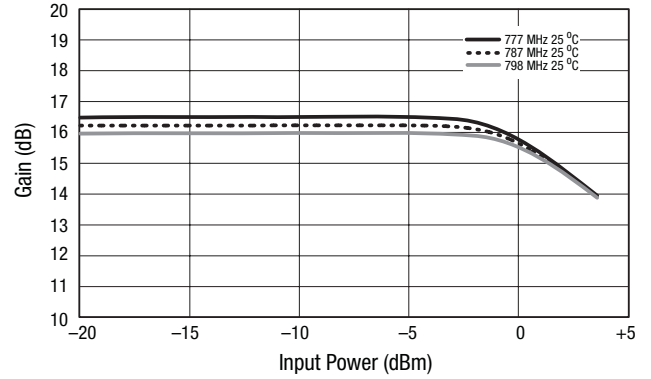

Figure 10. Gain vs Input Power Over Temperature and Frequency

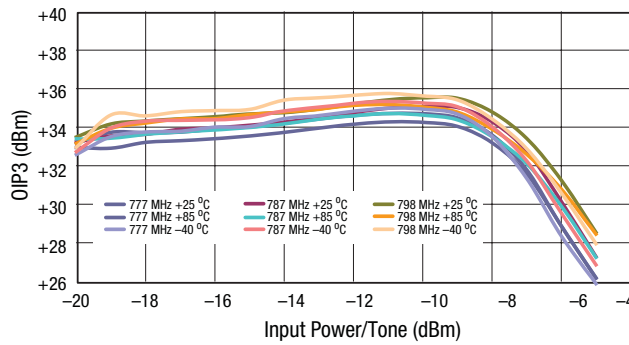
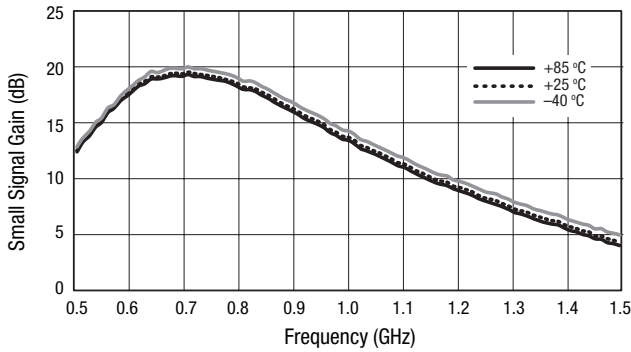

Figure 11. OIP3 vs Input Power Over Temperature and Frequency  
(Tone Spacing = 5 MHz)

### Typical Performance Characteristics

( $T_{OP} = +25\text{ }^{\circ}\text{C}$ , Characteristic Impedance [ $Z_0$ ] =  $50\ \Omega$ ,  $V_{DD} = 5\ \text{V}$ ,  $I_{DD} = 85\ \text{mA}$ , Parameters Include a Recommended 824-849 MHz Matching Network, Unless Otherwise Noted)



**Figure 12. Small Signal Gain vs Frequency Over Temperature**  
( $P_{IN} = -20\ \text{dBm}$ )

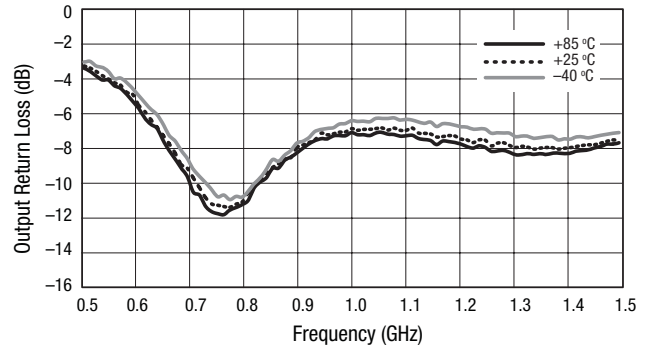

**Figure 13. Output Return Loss vs Frequency Over Temperature**  
 $P_{IN} = -20\ \text{dBm}$

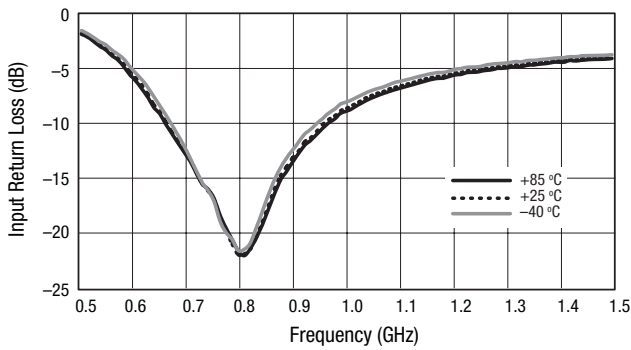

**Figure 14. Input Return Loss vs Frequency Over Temperature**  
( $P_{IN} = -20\ \text{dBm}$ )

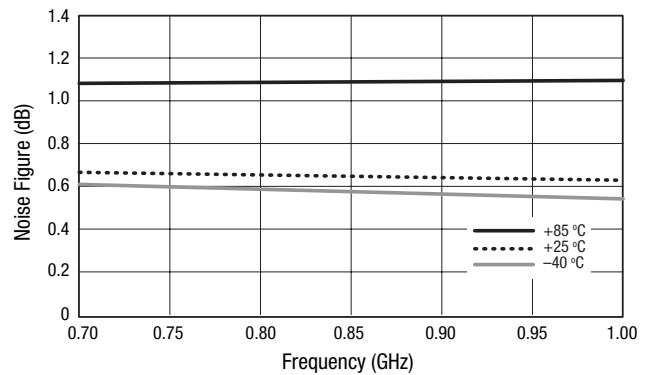

**Figure 15. Noise Figure vs Frequency Over Temperature**

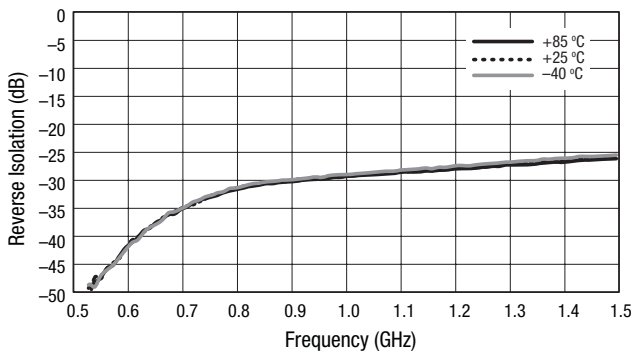

**Figure 16. Reverse Isolation vs Frequency Over Temperature**  
( $P_{IN} = -20\ \text{dBm}$ )

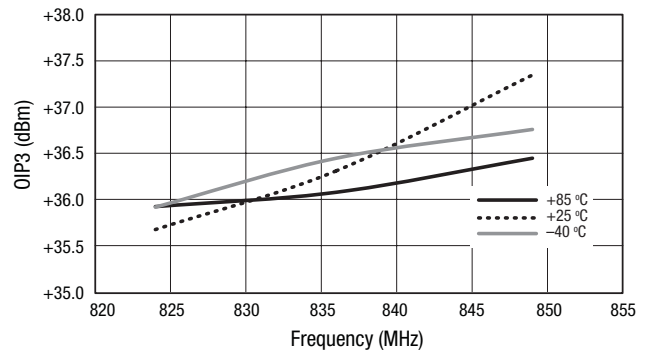

**Figure 17. OIP3 vs Frequency Over Temperature**  
( $P_{IN} = -18\ \text{dBm/Tone}$ , 5 MHz Tone Spacing)

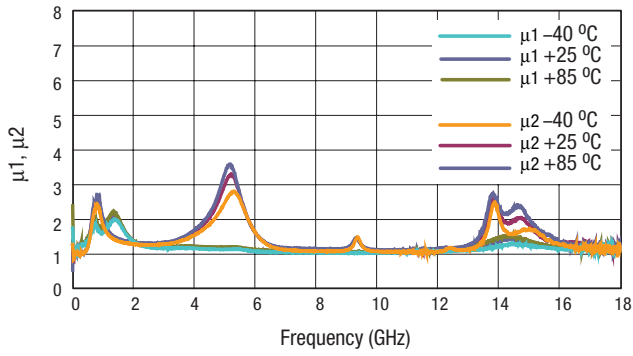

**Figure 18. Stability vs Frequency Over Temperature**  
( $P_{IN} = -20$  dBm)

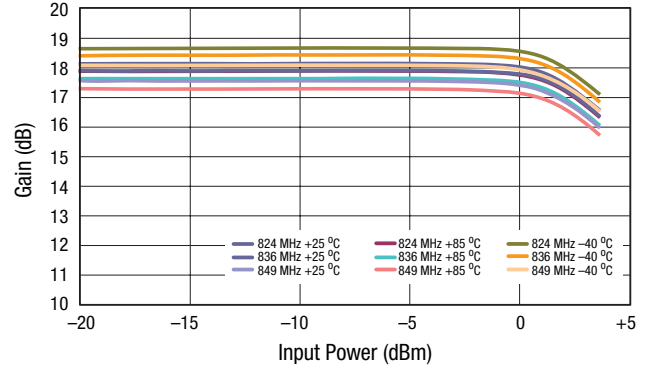

**Figure 19. Gain vs Input Power Over Temperature and Frequency**

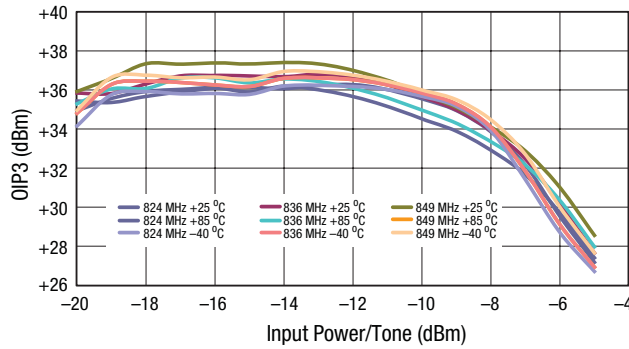
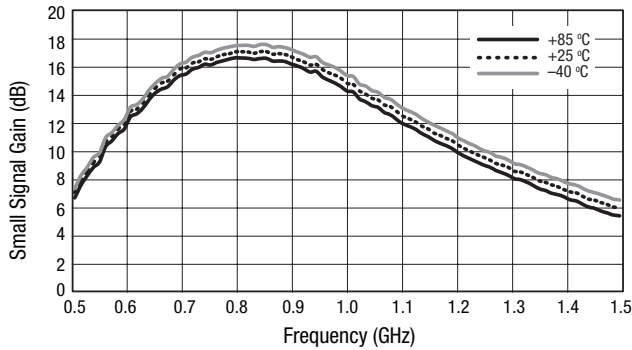

**Figure 20. OIP3 vs Input Power Over Temperature and Frequency**  
(Tone Spacing = 5 MHz)



### Typical Performance Characteristics

( $T_{OP} = +25\text{ }^{\circ}\text{C}$ , Characteristic Impedance [ $Z_0$ ] =  $50\ \Omega$ ,  $V_{DD} = 5\ \text{V}$ ,  $I_{DD} = 85\ \text{mA}$ , Parameters Include a Recommended 880-915 MHz Matching Network, Unless Otherwise Noted)



**Figure 21. Small Signal Gain vs Frequency Over Temperature**  
( $P_{IN} = -20\ \text{dBm}$ )

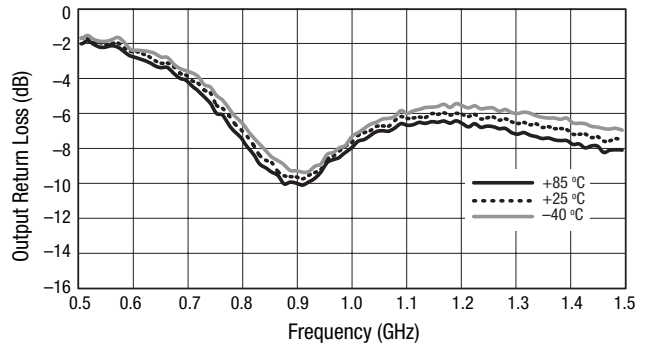

**Figure 22. Output Return Loss vs Frequency Over Temperature**  
 $P_{IN} = -20\ \text{dBm}$

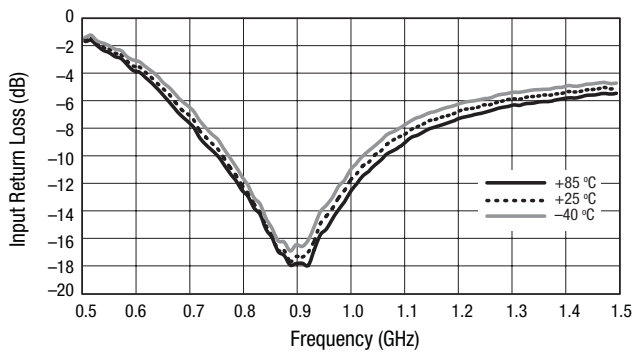

**Figure 23. Input Return Loss vs Frequency Over Temperature**  
( $P_{IN} = -20\ \text{dBm}$ )

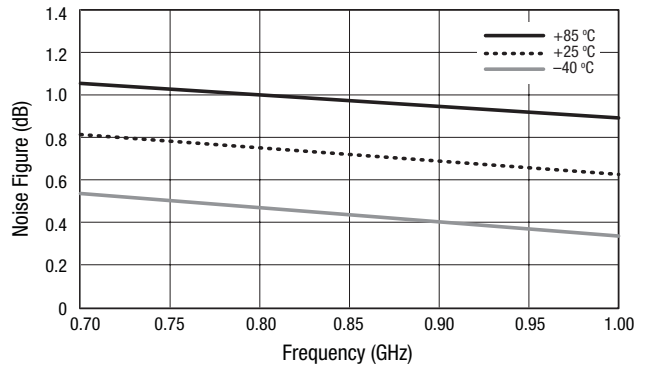

**Figure 24. Noise Figure vs Frequency Over Temperature**

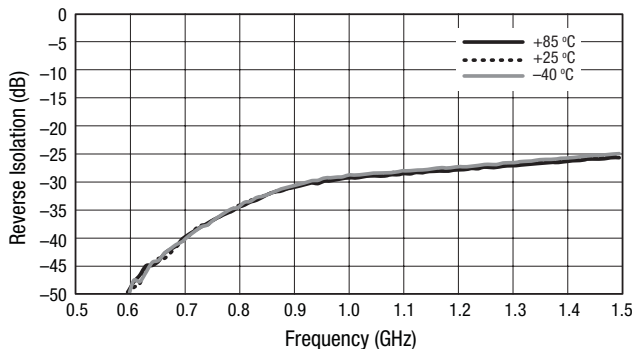

**Figure 25. Reverse Isolation vs Frequency Over Temperature**  
( $P_{IN} = -20\ \text{dBm}$ )

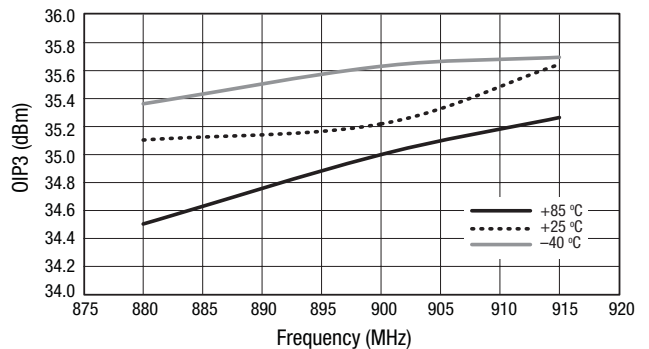

**Figure 26. OIP3 vs Frequency Over Temperature**  
( $P_{IN} = -18\ \text{dBm/Tone}$ , 5 MHz Tone Spacing)

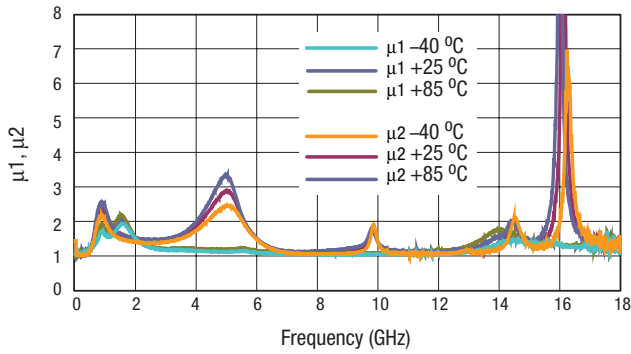

**Figure 27. Stability vs Frequency Over Temperature (P<sub>IN</sub> = -20 dBm)**

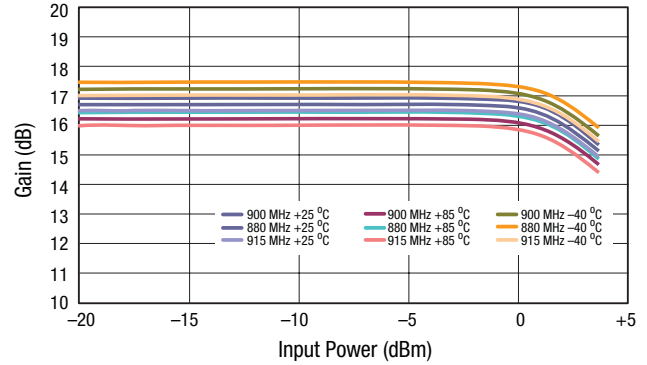

**Figure 28. Gain vs Input Power Over Temperature and Frequency**

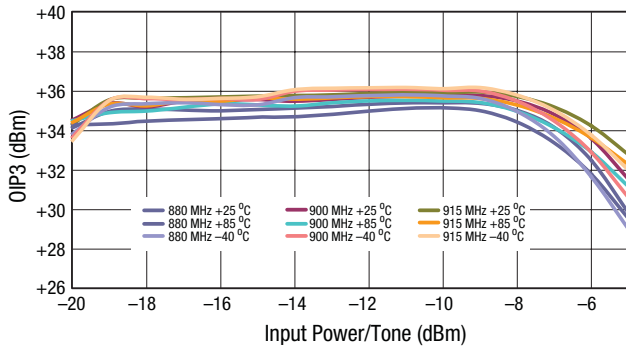

**Figure 29. OIP3 vs Input Power Over Temperature and Frequency (Tone Spacing = 5 MHz)**

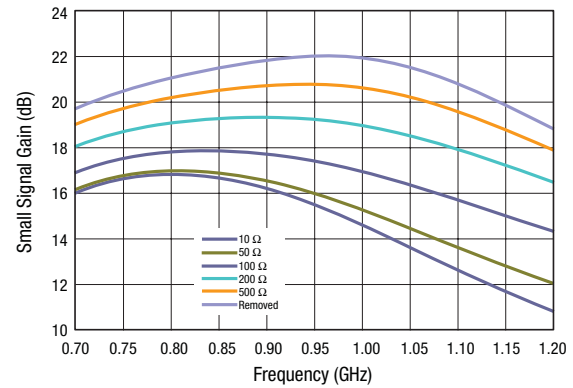

**Figure 30. Small Signal Gain vs Frequency for Multiple Feedback Resistor Values**

### Evaluation Board Description

The SKY65048-360LF Evaluation Board is used to test the performance of the SKY65048-360LF low noise amplifier. An assembly drawing for the Evaluation Board is shown in Figure 31. The Evaluation Board schematic diagram is shown in Figure 32.

Tables 5 and 6 provide the Evaluation Board reference circuit Bills of Materials (BOMs) for the 777 to 798 MHz frequency range and 824 to 849 frequency range, respectively. Table 7 provides the BOM for the available 880 to 915 MHz test board.

Input and output trace lengths have been minimized to reduce losses. All surface mount components are 0402-sized to reduce component parasitics. The use of 0603 or larger components is not recommended. Component spacing has also been minimized. The board is provisioned with two RF connectors and a DC launch. The RF connector and board loss up to component C1 is approximately 0.05 dB at 900 MHz.

It is very important to place multiple ground vias as close to shunt components as possible. This ensures proper grounding and circuit performance.

Board material is 10 mil thick VT47 FR4 with 1 oz. copper cladding. RF input and output traces are 50 Ω.

### Evaluation Board Test Procedure

- Step 1: Connect RF test equipment to amplifier input/output SMA connectors.
- Step 2: Connect DC ground.
- Step 3: Connect VDD to a +5 V supply with a current limit of 100 mA. Verify that the board draws approximately 85 mA.
- Step 4: Apply RF signal or noise source and verify performance detailed in Table 4.

### Package Dimensions

The PCB layout footprint for the SKY65048-360LF is shown in Figure 33. Typical case markings are shown in Figure 34. Package dimensions for the 8-pin QFN are shown in Figure 35, and tape and reel dimensions are provided in Figure 36.

**Package and Handling Information**

Instructions on the shipping container label regarding exposure to moisture after the container seal is broken must be followed. Otherwise, problems related to moisture absorption may occur when the part is subjected to high temperature during solder assembly.

THE SKY65048-360LF is rated to Moisture Sensitivity Level 1 (MSL1) at 260 °C. It can be used for lead or lead-free soldering.

Care must be taken when attaching this product, whether it is done manually or in a production solder reflow environment. Production quantities of this product are shipped in a standard tape and reel format. For packaging details, refer to the Skyworks Application Note, *Discrete Devices and IC Switch/Attenuators Tape and Reel Package Orientation*, document number 200083.

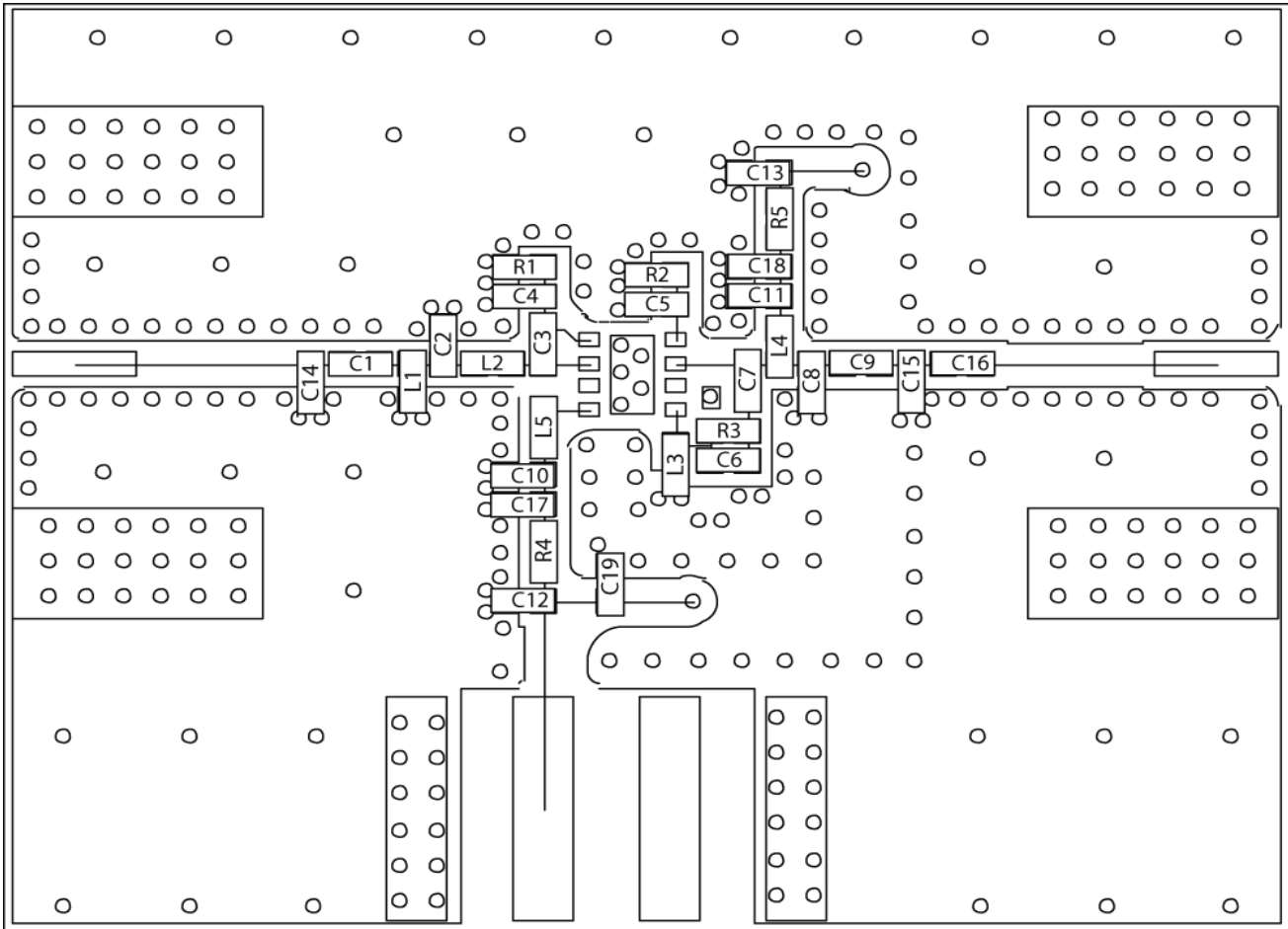

S1513

**Figure 31. SKY65048-360LF Evaluation Board Assembly Diagram**

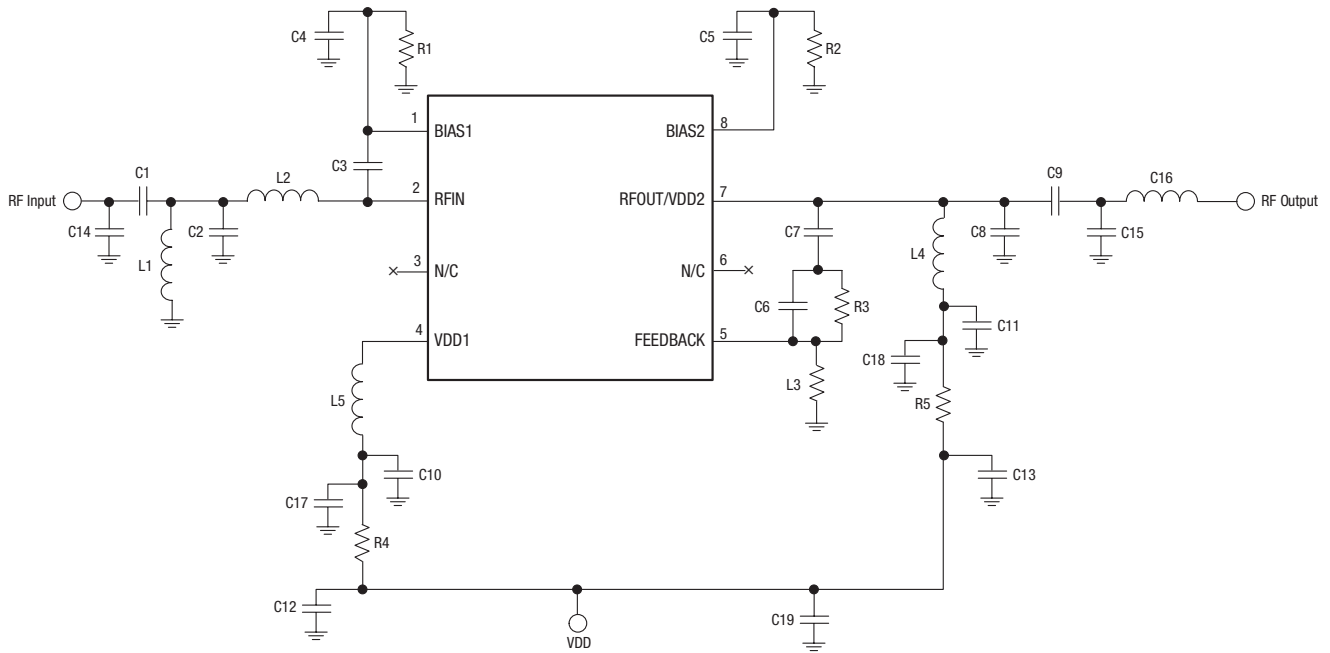

Note: Some component labels may be different than the corresponding component symbol shown here. Component values, however, as noted in Tables 5, 6, and 7 are accurate as of the date of this Data Sheet.

S1804

Figure 32. SKY65048-360LF Evaluation Board Schematic

**Table 5. SKY65048-360LF (QFN Package) Evaluation Board Bill of Materials (777 to 798 MHz)**

Component	Value	Size	Manufacturer	Part Series
C1	5 pF	SMT 0402	Murata	GJM
C2	0.5 pF	SMT 0402	Murata	GJM
C3, C8, C13, C14, C19	DNP	–	–	–
C4	4700 pF	SMT 0402	Murata	GRM
C5	1000 pF	SMT 0402	Murata	GRM
C6	0.5 pF	SMT 0402	Murata	GJM
C7	3.9 pF	SMT 0402	Murata	GRM
C9	30 pF	SMT 0402	Murata	GRM
C10	15 pF	SMT 0402	Murata	GRM
C11	1 pF	SMT 0402	Murata	GRM
C12	1000 pF	SMT 0402	Murata	GRM
C15	1.8 pF	SMT 0402	Murata	GRM
C16	1.5 nH	SMT 0402	Taiyo Yuden	–
C17	10 pF	SMT 0402	Murata	GRM
C18	1000 pF	SMT 0402	Murata	GRM
L1	11 nH	SMT 0402	Coilcraft	CS
L2	1.9 nH	SMT 0402	Coilcraft	CS
L3	3 k $\Omega$	SMT 0402	Panasonic	–
L4	8.2 nH	SMT 0402	Taiyo Yuden	–
L5	15 nH	SMT 0402	Taiyo Yuden	–
R1	12 $\Omega$	SMT 0402	Panasonic	–
R2	9.1 $\Omega$	SMT 0402	Panasonic	–
R3	10 $\Omega$	SMT 0402	Panasonic	–
R4	5.1 $\Omega$	SMT 0402	Panasonic	–
R5	7.5 $\Omega$	SMT 0402	Panasonic	–

**Table 6. SKY65048-360LF (QFN Package) Evaluation Board Bill of Materials (824 to 849 MHz)**

Component	Value	Size	Manufacturer	Part Series
C1	5 pF	SMT 0402	Murata	GJM
C2	0.5 pF	SMT 0402	Murata	GJM
C3, C8, C13, C14, C19	DNP	–	–	–
C4	4700 pF	SMT 0402	Murata	GRM
C5	1000 pF	SMT 0402	Murata	GRM
C6	0.5 pF	SMT 0402	Murata	GJM
C7	2.7 pF	SMT 0402	Murata	GRM
C9	30 pF	SMT 0402	Murata	GRM
C10	15 pF	SMT 0402	Murata	GRM
C11	1 pF	SMT 0402	Murata	GRM
C12	1000 pF	SMT 0402	Murata	GRM
C15	1.8 pF	SMT 0402	Murata	GRM
C16	1.5 nH	SMT 0402	Taiyo Yuden	–
C17	10 pF	SMT 0402	Murata	GRM
C18	1000 pF	SMT 0402	Murata	GRM
L1	11 nH	SMT 0402	Coilcraft	CS
L2	1.9 nH	SMT 0402	Coilcraft	CS
L3	3 k $\Omega$	SMT 0402	Panasonic	–
L4	10 nH	SMT 0402	Taiyo Yuden	–
L5	15 nH	SMT 0402	Taiyo Yuden	–
R1	12 $\Omega$	SMT 0402	Panasonic	–
R2	9.1 $\Omega$	SMT 0402	Panasonic	–
R3	10 $\Omega$	SMT 0402	Panasonic	–
R4	5.1 $\Omega$	SMT 0402	Panasonic	–
R5	7.5 $\Omega$	SMT 0402	Panasonic	–

**Table 7. SKY65048-360LF (QFN Package) Evaluation Board Bill of Materials (880 to 915 MHz)**

Component	Value	Size	Manufacturer	Part Series
C1	5 pF	SMT 0402	Murata	GJM
C2	0.2 pF	SMT 0402	Murata	GJM
C3, C8, C13, C14, C19	DNP	–	–	–
C4	1000 pF	SMT 0402	Murata	GRM
C5	1000 pF	SMT 0402	Murata	GRM
C6	0.5 pF	SMT 0402	Murata	GJM
C7	2.2 pF	SMT 0402	Murata	GRM
C9	30 pF	SMT 0402	Murata	GRM
C10	12 pF	SMT 0402	Murata	GRM
C11	1 pF	SMT 0402	Murata	GRM
C12	1000 pF	SMT 0402	Murata	GRM
C15	1.8 pF	SMT 0402	Murata	GRM
C16	1.5 nH	SMT 0402	Taiyo Yuden	HK
C17	10 pF	SMT 0402	Murata	GRM
C18	1000 pF	SMT 0402	Murata	GRM
L1	11 nH	SMT 0402	Coilcraft	HP
L2	1.9 nH	SMT 0402	Coilcraft	HP
L3	3 k $\Omega$	SMT 0402	Panasonic	–
L4	5.6 nH	SMT 0402	Taiyo Yuden	HK
L5	12 nH	SMT 0402	Taiyo Yuden	HK
R1	12 $\Omega$	SMT 0402	Panasonic	–
R2	9.1 $\Omega$	SMT 0402	Panasonic	–
R3	10 $\Omega$	SMT 0402	Panasonic	–
R4	5.1 $\Omega$	SMT 0402	Panasonic	–
R5	7.5 $\Omega$	SMT 0402	Panasonic	–

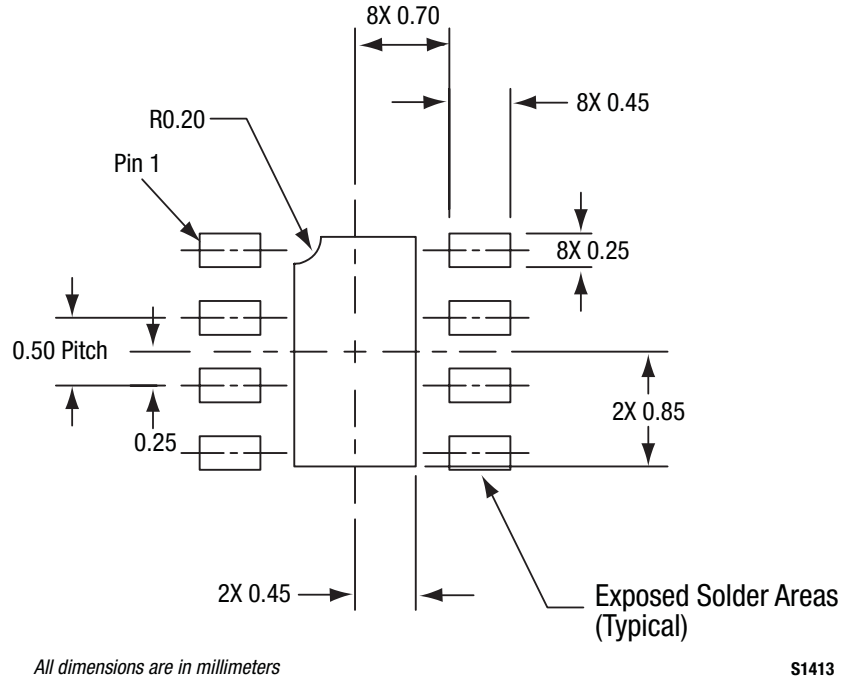

Figure 33. SKY65048-360LF PCB Layout Footprint

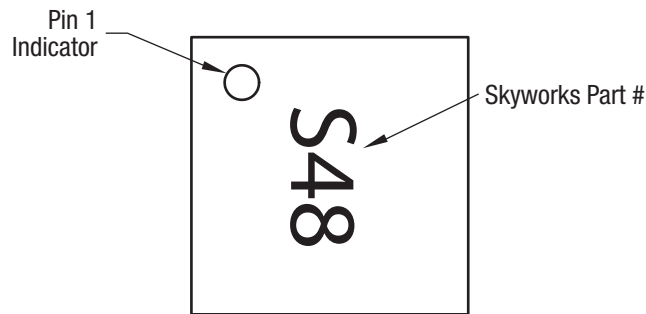
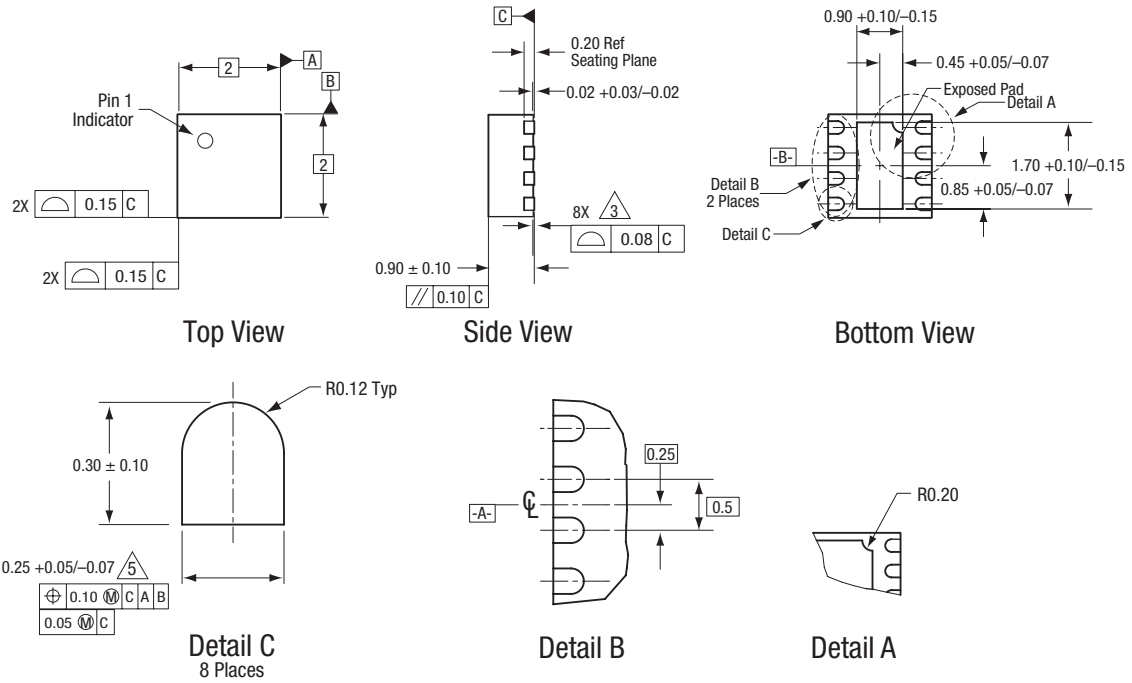

Figure 34. Typical Case Markings





All measurements are in millimeters.  
 Dimensioning and tolerancing according to ASME Y14.5M-1994.  
 Coplanarity applies to the exposed heat sink slug as well as the terminals.  
 Plating requirement per source control drawing (SCD) 2504.  
 Dimension applies to metallized terminal and is measured between 0.15 mm and 0.30 mm from terminal tip.

S1415

Figure 35. SKY65048-360LF 8-Pin QFN Package Dimensions

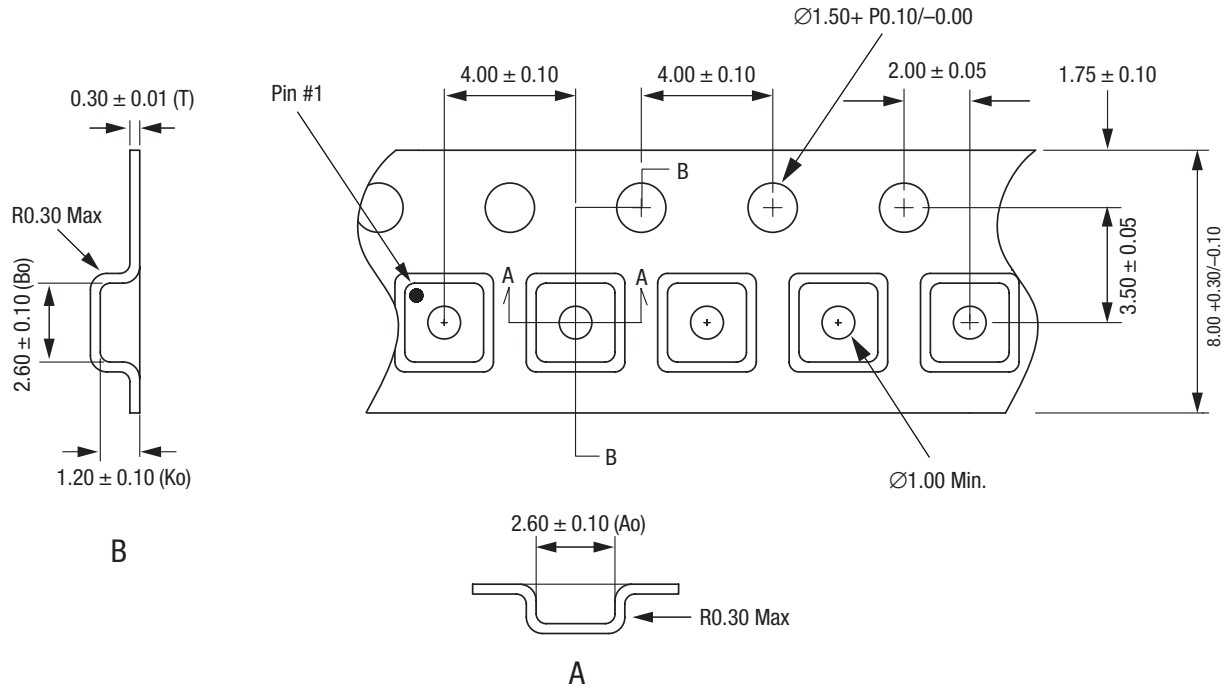

- Notes:
1. Carrier tape: black conductive polystyrene.
  2. Cover tape material: transparent conductive HSA.
  3. Cover tape size: 5.40 mm width.
  4. All measurements are in millimeters.

S1480

Figure 36. SKY65048-360LF Tape and Reel Dimensions

**Ordering Information**

Model Name	Manufacturing Part Number	Evaluation Board Part Number
SKY65048-360LF Low Noise Amplifier	SKY65048-360LF (Pb-free and Green package)	SKY65048-360LF (880-915 MHz)

Copyright © 2009 Skyworks Solutions, Inc. All Rights Reserved.

Information in this document is provided in connection with Skyworks Solutions, Inc. ("Skyworks") products or services. These materials, including the information contained herein, are provided by Skyworks as a service to its customers and may be used for informational purposes only by the customer. Skyworks assumes no responsibility for errors or omissions in these materials or the information contained herein. Skyworks may change its documentation, products, services, specifications or product descriptions at any time, without notice. Skyworks makes no commitment to update the materials or information and shall have no responsibility whatsoever for conflicts, incompatibilities, or other difficulties arising from any future changes.

No license, whether express, implied, by estoppel or otherwise, is granted to any intellectual property rights by this document. Skyworks assumes no liability for any materials, products or information provided hereunder, including the sale, distribution, reproduction or use of Skyworks products, information or materials, except as may be provided in Skyworks Terms and Conditions of Sale.

THE MATERIALS, PRODUCTS AND INFORMATION ARE PROVIDED "AS IS" WITHOUT WARRANTY OF ANY KIND, WHETHER EXPRESS, IMPLIED, STATUTORY, OR OTHERWISE, INCLUDING FITNESS FOR A PARTICULAR PURPOSE OR USE, MERCHANTABILITY, PERFORMANCE, QUALITY OR NON-INFRINGEMENT OF ANY INTELLECTUAL PROPERTY RIGHT; ALL SUCH WARRANTIES ARE HEREBY EXPRESSLY DISCLAIMED. SKYWORKS DOES NOT WARRANT THE ACCURACY OR COMPLETENESS OF THE INFORMATION, TEXT, GRAPHICS OR OTHER ITEMS CONTAINED WITHIN THESE MATERIALS. SKYWORKS SHALL NOT BE LIABLE FOR ANY DAMAGES, INCLUDING BUT NOT LIMITED TO ANY SPECIAL, INDIRECT, INCIDENTAL, STATUTORY, OR CONSEQUENTIAL DAMAGES, INCLUDING WITHOUT LIMITATION, LOST REVENUES OR LOST PROFITS THAT MAY RESULT FROM THE USE OF THE MATERIALS OR INFORMATION, WHETHER OR NOT THE RECIPIENT OF MATERIALS HAS BEEN ADVISED OF THE POSSIBILITY OF SUCH DAMAGE.

Skyworks products are not intended for use in medical, lifesaving or life-sustaining applications, or other equipment in which the failure of the Skyworks products could lead to personal injury, death, physical or environmental damage. Skyworks customers using or selling Skyworks products for use in such applications do so at their own risk and agree to fully indemnify Skyworks for any damages resulting from such improper use or sale.

Customers are responsible for their products and applications using Skyworks products, which may deviate from published specifications as a result of design defects, errors, or operation of products outside of published parameters or design specifications. Customers should include design and operating safeguards to minimize these and other risks. Skyworks assumes no liability for applications assistance, customer product design, or damage to any equipment resulting from the use of Skyworks products outside of stated published specifications or parameters.

Skyworks, the Skyworks symbol, and "Breakthrough Simplicity" are trademarks or registered trademarks of Skyworks Solutions, Inc., in the United States and other countries. Third-party brands and names are for identification purposes only, and are the property of their respective owners. Additional information, including relevant terms and conditions, posted at [www.skyworksinc.com](http://www.skyworksinc.com), are incorporated by reference.