

DATA SHEET

SKY67215-11: 400-700 MHz Low-Noise Amplifier Module

Applications

- Public safety radio
- ISM systems
- Military radio
- Mobile computing
- Wireless sensors

Features

- Requires only one external component
- Optimized for 400 to 700 MHz operation
- Noise Figure: 0.67 dB typical @ 500 MHz
- Gain: 21.7 dB typical @ 500 MHz
- Input return loss: 16.8 dB typical @ 500 MHz
- Operating voltage range: 3.3 to 5.0 V
- Adjustable supply current: 30 to 100 mA
- High linearity IIP3: +13.8 dBm typical @ 500 MHz
- MCM (16-pin, 4 x 4 mm) package (MSL3, 260 °C per JEDEC J-STD-020) package



Skyworks Green™ products are compliant with all applicable legislation and are halogen-free. For additional information, refer to *Skyworks Definition of Green™*, document number SQ04-0074.

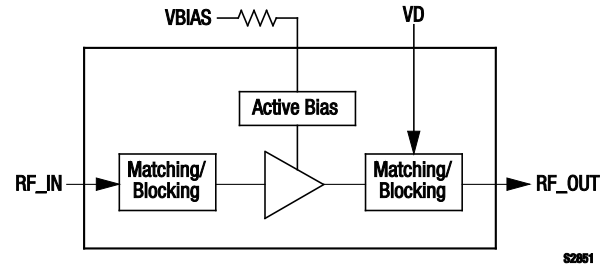

Figure 1. SKY67215-11 LNA Block Diagram

Description

The SKY67215-11 is a high performance, Low-Noise Amplifier (LNA) designed for use in 400 to 700 MHz wireless infrastructure applications. The device consists of a single high linearity, LNA and all associated matching components. The only external component necessary for proper operation is an external resistor, used to set the DC current. The device is also completely DC bypassed.

The package design nearly eliminates external surface mount components, greatly reduces printed circuit board area, and offers low thermal resistance for enhanced Mean Time Between Failures (MTBFs).

For optimum performance in the following frequency ranges, refer to the following product Data Sheets (all devices are pin-to-pin compatible with the SKY67215-11):

- 0.7 GHz to 1.2 GHz: SKY67216-11 (document #201808)
- 1.6 GHz to 2.1 GHz: SKY67221-11 (document #201838)
- 2.2 GHz to 3.0 GHz: SKY67226-11 (document #201841)

The SKY67215-11 is packaged in a 16-pin, 4 x 4 mm Multi-Chip Module (MCM). A block diagram of the SKY67215-11 is shown in Figure 1. The device package and pinout are shown in Figure 2.

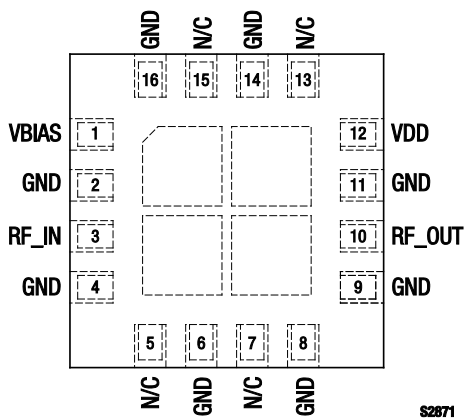

Figure 2. SKY67215-11 Pinout – 16-Pin MCM Package (Top View)

Electrical and Mechanical Specifications

Signal pin assignments and functional pin descriptions are described in Table 1. The absolute maximum ratings of the SKY67215-11 are provided in Table 2. Electrical specifications are provided in Table 3.

Typical performance characteristics of the SKY67215-11 are illustrated in Figures 3 through 23 (75 mA supply current), Figures 24 through 35 (100 mA supply current), and Figures 36 through 47 (45 mA supply current).

Package and Handling Information

Since the device package is sensitive to moisture absorption, it is baked and vacuum packed before shipping. Instructions on the

shipping container label regarding exposure to moisture after the container seal is broken must be followed. Otherwise, problems related to moisture absorption may occur when the part is subjected to high temperature during solder assembly.

The SKY67215-11 is rated to Moisture Sensitivity Level 3 (MSL3) at 260 °C. It can be used for lead or lead-free soldering. For additional information, refer to the Skyworks Application Note *PCB Design and SMT Assembly/Rework Guidelines for MCM-L Packages*, document number 101752.

Care must be taken when attaching this product, whether it is done manually or in a production solder reflow environment. Production quantities of this product are shipped in a standard tape and reel format.

Table 1. SKY67215-11 Signal Descriptions

Pin #	Name	Description	Pin #	Name	Description
1	VBIAS	Low current bias for amplifier. External resistor sets current consumption.	9	GND	Ground
2	GND	Ground	10	RF_OUT	RF output, AC coupled. No external components required.
3	RF_IN	RF input, AC coupled. No external components required.	11	GND	Ground
4	GND	Ground	12	VDD	High current amplifier bias connection. No external bypassing required.
5	N/C	No connection	13	N/C	No connection
6	GND	Ground	14	GND	Ground
7	N/C	No connection	15	N/C	No connection
8	GND	Ground	16	GND	Ground

Table 2. Absolute Maximum Ratings

Parameter	Symbol	Minimum	Maximum	Units
Supply voltage	V _{DD}		5.5	V
RF input power	P _{IN}		+20	dBm
Channel temperature	T _{CH}		150	°C
Operating temperature	T _A	-55	+100	°C
Storage temperature	T _{STG}	-65	+150	°C
Thermal resistance	Θ _{JC}		68.8	°C/W

Note: Exposure to maximum rating conditions for extended periods may reduce device reliability. There is no damage to device with only one parameter set at the limit and all other parameters set at or below their nominal value. Exceeding any of the limits listed here may result in permanent damage to the device.

CAUTION: Although this device is designed to be as robust as possible, Electrostatic Discharge (ESD) can damage this device. This device must be protected at all times from ESD. Static charges may easily produce potentials of several kilovolts on the human body or equipment, which can discharge without detection. Industry-standard ESD precautions should be used at all times. The SKY67215-11 ESD threshold level is 500 VDC using Human Body Model (HBM) testing (Class 1B), 50 VDC using Man-Machine (MM) model testing (Class A), and 1000 VDC using Charged Device Model (CDM) testing (Class IV).

Table 3. SKY67215-11 Electrical Characteristics (Note 1) (Note 2) (Note 3)

(V_{DD} = V_{BIAS} = 5 V Nominal, I_{DD} = 75 mA, T_A = +25 °C, Characteristic Impedance [Z₀] = 50 Ω, Unless Otherwise Noted)

Parameter	Symbol	Test Conditions	Minimum	Typical	Maximum	Units
RF Specifications						
Noise Figure (Note 4)	NF	@ 500 MHz		0.67	1.00	dB
Small signal gain	IS21I	@ 500 MHz	20.0	21.7		dB
Input return loss	IS11I	@ 500 MHz	12.5	16.8		dB
Output return loss	IS22I	@ 500 MHz	7	9		dB
Reverse isolation	IS12I	@ 500 MHz	28.0	30.9		dB
3 rd Order Input Intercept Point	IIP3	@ 500 MHz, Δf = 1 MHz, P _{IN} = -20 dBm/tone	+10.8	+13.8		dBm
3 rd Order Output Intercept Point	OIP3	@ 500 MHz, Δf = 1 MHz, P _{IN} = -20 dBm/tone	+32.5	+35.5		dBm
Input 1dB Compression Point	IP1dB	@ 500 MHz	-4.2	-2.2		dBm
Output 1dB Compression Point	OP1dB	@ 500 MHz	+16.5	+18.5		dBm
Stability (Note 3)	μ1, μ2, K, B	Up to 18 GHz, -40 °C to +85 °C		>1		-
DC Specifications						
Supply voltage	V _{DD}			5		V
Quiescent current	I _{DD}	R _{BIAS} = 7.5 kΩ		75		mA

Note 1: Performance is guaranteed only under the conditions listed in this Table.

Note 2: Circuit topology optimized for best compromise between NF, S₁₁, IIP3, and IP1dB.

Note 3: Applies to typical application circuit and components shown in Figure 24.

Note 4: Loss from input SMA connector and Evaluation Board up to pin 3 of device has not been de-embedded from the NF measurement.

Table 4. SKY67215-11 Electrical Characteristics (Note 1) (Note 2) (Note 3)
(V_{DD} = VBIAS = 5 V Nominal, I_{DD} = 100 mA, T_A = +25 °C, Characteristic Impedance [Z₀] = 50 Ω, Unless Otherwise Noted)

Parameter	Symbol	Test Conditions	Minimum	Typical	Maximum	Units
RF Specifications						
Noise Figure (Note 4)	NF	@ 400 MHz @434 MHz @500 MHz @700 MHz		0.88 0.78 0.70 0.68		dB dB dB dB
Small signal gain	IS211	@ 400 MHz @434 MHz @500 MHz @700 MHz		23.3 22.5 21.6 19.4		dB dB dB dB
Input return loss	IS111	@ 400 MHz @434 MHz @500 MHz @700 MHz		20.8 19.0 14.9 23.0		dB dB dB dB
Output return loss	IS221	@ 400 MHz @434 MHz @500 MHz @700 MHz		9.2 8.6 8.8 8.4		dB dB dB dB
Reverse isolation	IS121	@ 400 MHz @434 MHz @500 MHz @700 MHz		32.5 31.7 30.5 28.8		dB dB dB dB
3 rd Order Input Intercept Point	IIP3	Δf = 1 MHz, P _{IN} = -20 dBm/tone: @ 400 MHz @434 MHz @500 MHz @700 MHz		+9.95 +11.5 +13.9 +20.1		dBm dBm dBm dBm
3 rd Order Output Intercept Point	OIP3	Δf = 1 MHz, P _{IN} = -20 dBm/tone: @ 400 MHz @434 MHz @500 MHz @700 MHz		+33.25 +34.00 +35.50 +39.50		dBm dBm dBm dBm
Input 1dB Compression Point	IP1dB	@ 400 MHz @434 MHz @500 MHz @700 MHz		-6.0 -5.0 -2.6 -2.0		dBm dBm dBm dBm
Output 1dB Compression Point	OP1dB	@ 400 MHz @434 MHz @500 MHz @700 MHz		+16.5 +16.7 +18.2 +20.4		dBm dBm dBm dBm
Stability (Note 3)	μ1, μ2, K, B	Up to 18 GHz, -40 °C to +85 °C		>1		-
DC Specifications						
Supply voltage	V _{DD}			5		V
Quiescent current	I _{DD}	R _{BIAS} = 6.2 kΩ		100		mA

Note 1: Performance is guaranteed only under the conditions listed in this Table.

Note 2: Circuit topology optimized for best compromise between NF, S₁₁, IIP3, and IP1dB.

Note 3: Applies to typical application circuit and components shown in Figure 24.

Note 4: Loss from input SMA connector and Evaluation Board up to pin 3 of device has not been de-embedded from the NF measurement.

Table 5. SKY67215-11 Electrical Characteristics (Note 1) (Note 2) (Note 3)
(V_{DD} = VBIAS = 5 V Nominal, I_{DD} = 45 mA, T_A = +25 °C, Characteristic Impedance [Z₀] = 50 Ω, Unless Otherwise Noted)

Parameter	Symbol	Test Conditions	Minimum	Typical	Maximum	Units
RF Specifications						
Noise Figure (Note 4)	NF	@ 400 MHz @434 MHz @500 MHz @700 MHz		0.87 0.76 0.67 0.66		dB dB dB dB
Small signal gain	IS211	@ 400 MHz @434 MHz @500 MHz @700 MHz		22.60 21.75 21.30 18.30		dB dB dB dB
Input return loss	IS111	@ 400 MHz @434 MHz @500 MHz @700 MHz		13.50 14.40 15.77 26.34		dB dB dB dB
Output return loss	IS221	@ 400 MHz @434 MHz @500 MHz @700 MHz		9.7 8.7 8.9 8.0		dB dB dB dB
Reverse isolation	IS121	@ 400 MHz @434 MHz @500 MHz @700 MHz		32.4 32.0 31.0 29.6		dB dB dB dB
3 rd Order Input Intercept Point	IIP3	$\Delta f = 1$ MHz, P _{IN} = -20 dBm/tone: @ 400 MHz @434 MHz @500 MHz @700 MHz		+7.50 +9.05 +11.20 +12.60		dBm dBm dBm dBm
3 rd Order Output Intercept Point	OIP3	$\Delta f = 1$ MHz, P _{IN} = -20 dBm/tone: @ 400 MHz @434 MHz @500 MHz @700 MHz		+30.1 +30.8 +32.5 +30.9		dBm dBm dBm dBm
Input 1dB Compression Point	IP1dB	@ 400 MHz @434 MHz @500 MHz @700 MHz		-5.5 -4.0 -2.2 -2.0		dBm dBm dBm dBm
Output 1dB Compression Point	OP1dB	@ 400 MHz @434 MHz @500 MHz @700 MHz		+16.1 +16.7 +18.1 +20.3		dBm dBm dBm dBm
Stability (Note 3)	$\mu 1, \mu 2, K, B$	Up to 18 GHz, -40 °C to +85 °C		>1		-
DC Specifications						
Supply voltage	V _{DD}			5		V
Quiescent current	I _{DD}	R _{BIAS} = 12 kΩ		45		mA

Note 1: Performance is guaranteed only under the conditions listed in this Table.

Note 2: Circuit topology optimized for best compromise between NF, S₁₁, IIP3, and IP1dB.

Note 3: Applies to typical application circuit and components shown in Figure 24.

Note 4: Loss from input SMA connector and Evaluation Board up to pin 3 of device has not been de-embedded from the NF measurement.

Typical Performance Characteristics @ I_{DD} = 75 mA
 (V_{DD} = VBIAS = 5 V Nominal, T_A = +25 °C, Characteristic Impedance [Z₀] = 50 Ω, Unless Otherwise Noted)

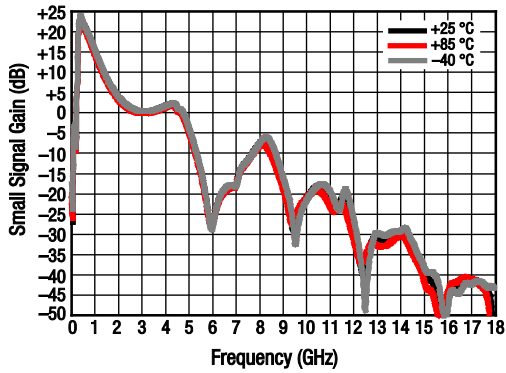

Figure 3. Broadband Gain Response vs Frequency Over Temperature

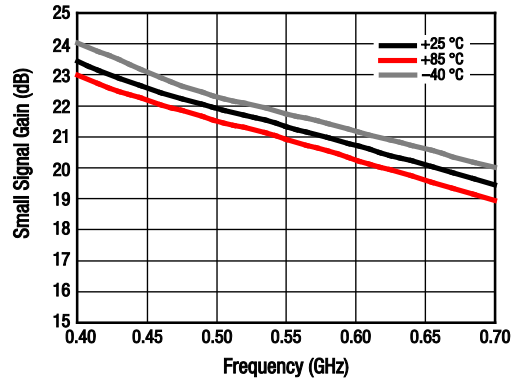

Figure 4. Narrowband Gain Response vs Frequency Over Temperature

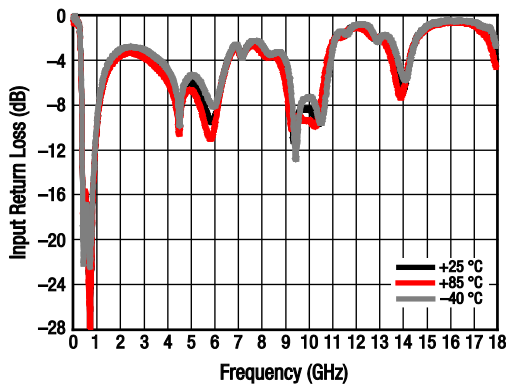

Figure 5. Broadband Input Return Loss vs Frequency Over Temperature

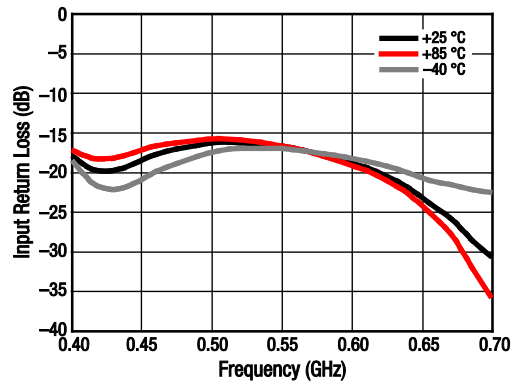

Figure 6. Narrowband Input Return Loss vs Frequency Over Temperature

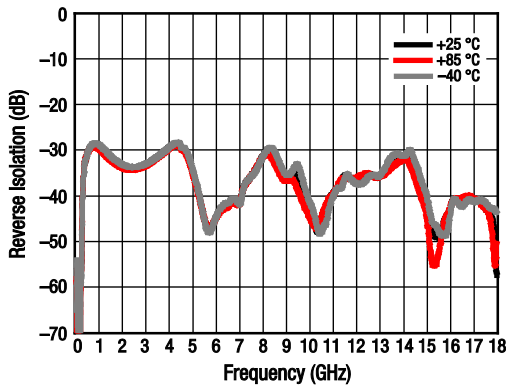

Figure 7. Broadband Reverse Isolation vs Frequency Over Temperature

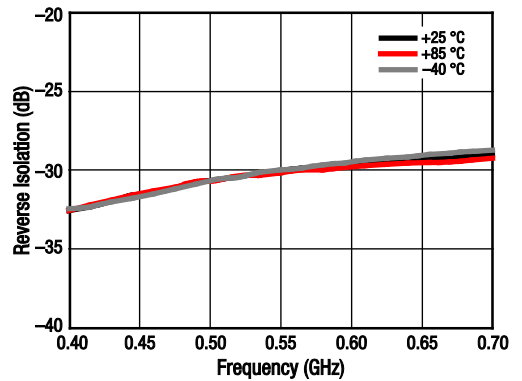

Figure 8. Narrowband Reverse Isolation vs Frequency Over Temperature

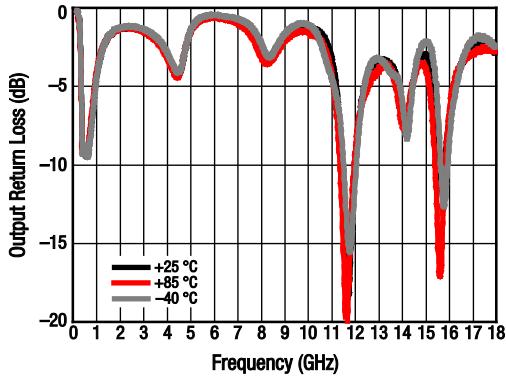

Figure 9. Broadband Output Return Loss vs Frequency Over Temperature

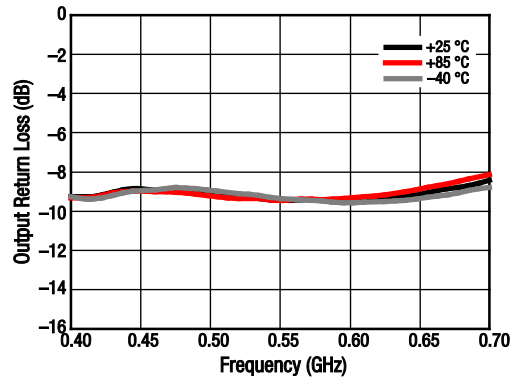

Figure 10. Narrowband Output Return Loss vs Frequency Over Temperature

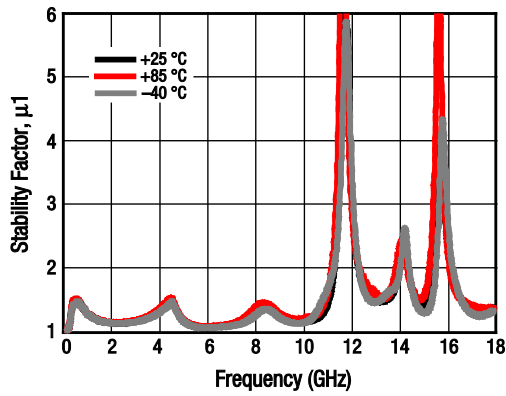

Figure 11. Stability Factor (μ_1) vs Frequency Over Temperature

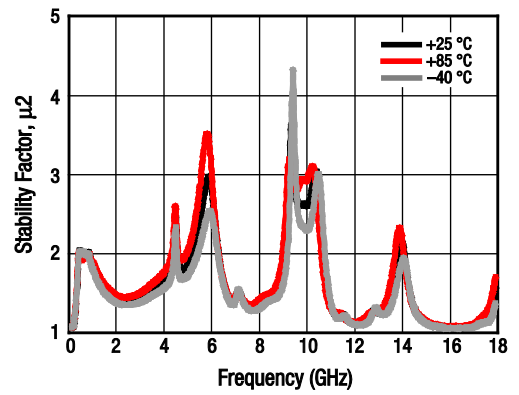

Figure 12. Stability Factor (μ_2) vs Frequency Over Temperature

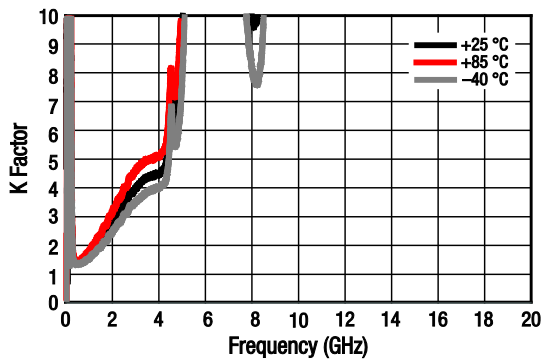

Figure 13. Stability Factor (K) vs Frequency Over Temperature

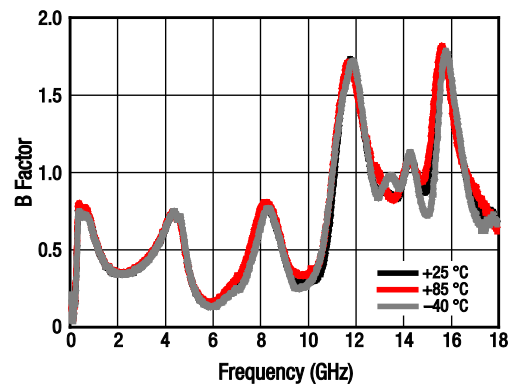

Figure 14. Stability Factor (B) vs Frequency Over Temperature

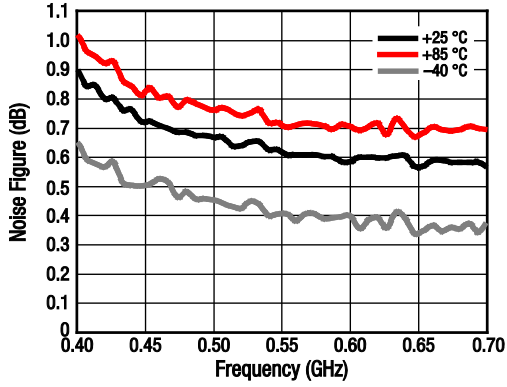

Figure 15. Noise Figure vs Frequency Over Temperature

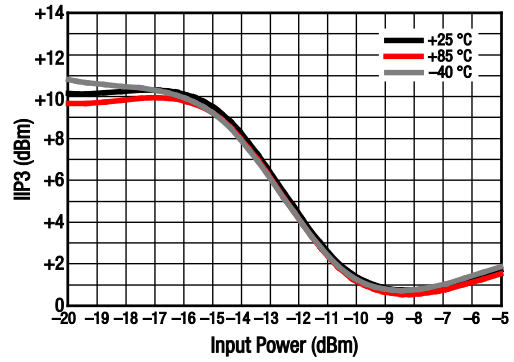

Figure 16. IIP3 vs Input Power Over Temperature @ 400 MHz (P_{IN} = -20 dBm, Tone Spacing = 1 MHz)

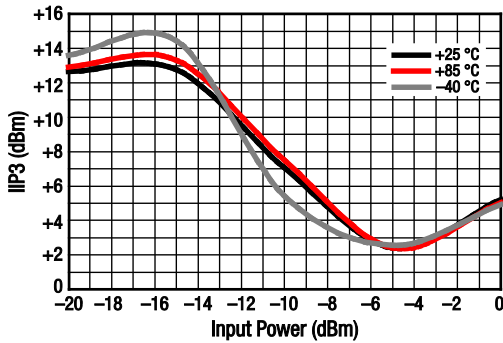

Figure 17. IIP3 vs Input Power Over Temperature @ 500 MHz (P_{IN} = -20 dBm, Tone Spacing = 1 MHz)

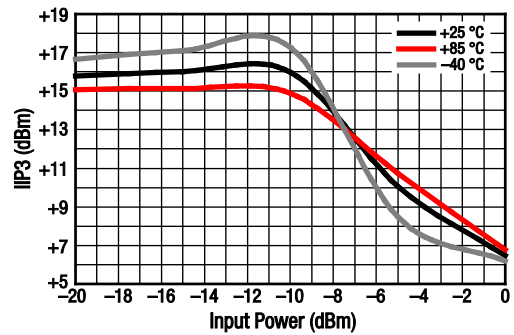

Figure 18. IIP3 vs Input Power Over Temperature @ 700 MHz (P_{IN} = -20 dBm, Tone Spacing = 1 MHz)

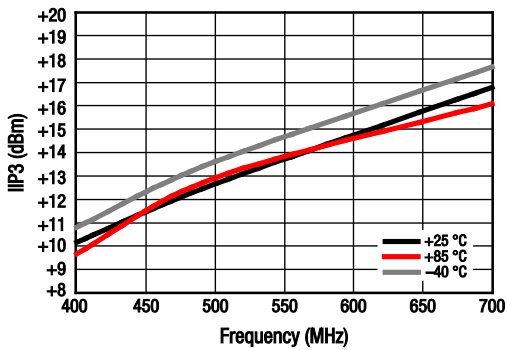

Figure 19. IIP3 vs Frequency Over Temperature (P_{IN} = -20 dBm, Tone Spacing = 1 MHz)

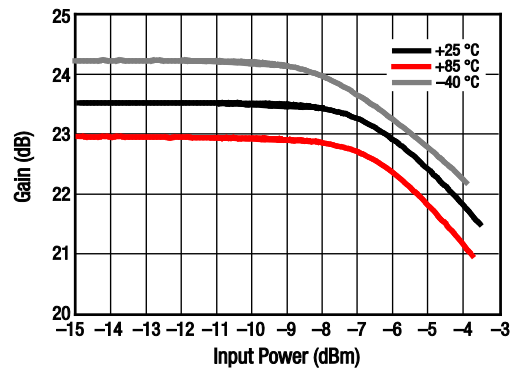

Figure 20. Gain vs Input Power Over Temperature @ 400 MHz

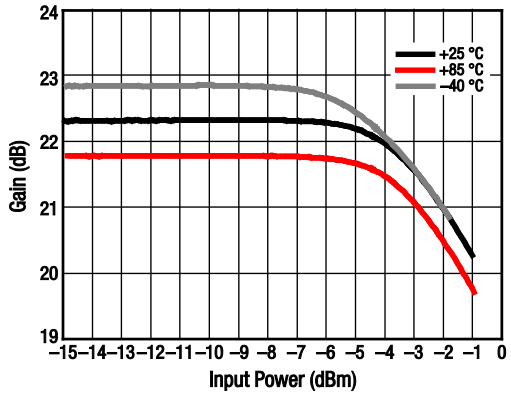

Figure 21. Gain vs Input Power Over Temperature @ 500 MHz

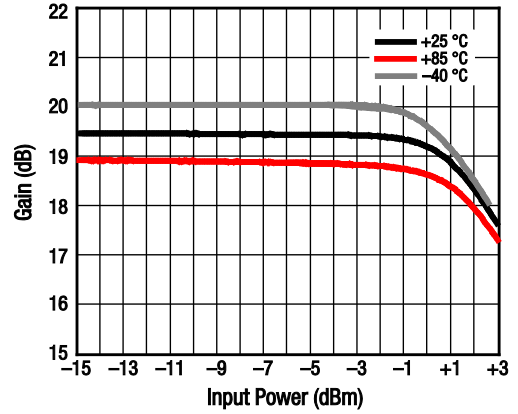

Figure 22. Gain vs Input Power Over Temperature @ 700 MHz

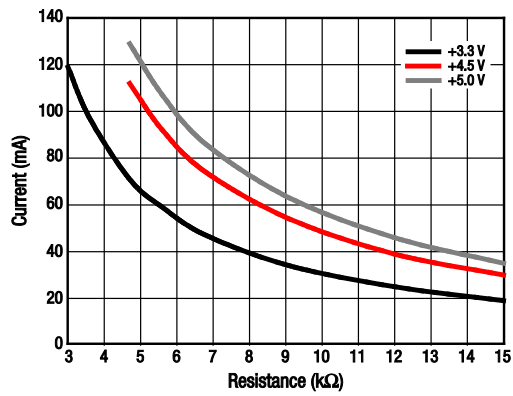

Figure 23. Resistor R1 vs Current Over Voltage

Evaluation Board Description

The SKY67215-11 Evaluation Board is used to test the performance of the SKY67215-11 LNA. The Evaluation Board schematic diagram is shown in Figure 24. An assembly drawing for the Evaluation Board is shown in Figure 25. The layer detail physical characteristics are noted in Figure 26. Table 6 provides the Bill of Materials (BOM) list for Evaluation Board components.

Package Dimensions

The PCB layout footprint for the SKY67215-11 is shown in Figure 27. Typical case markings are shown in Figure 28. Package dimensions for the 16-pin MCM are shown in Figure 29, and tape and reel dimensions are provided in Figure 30.

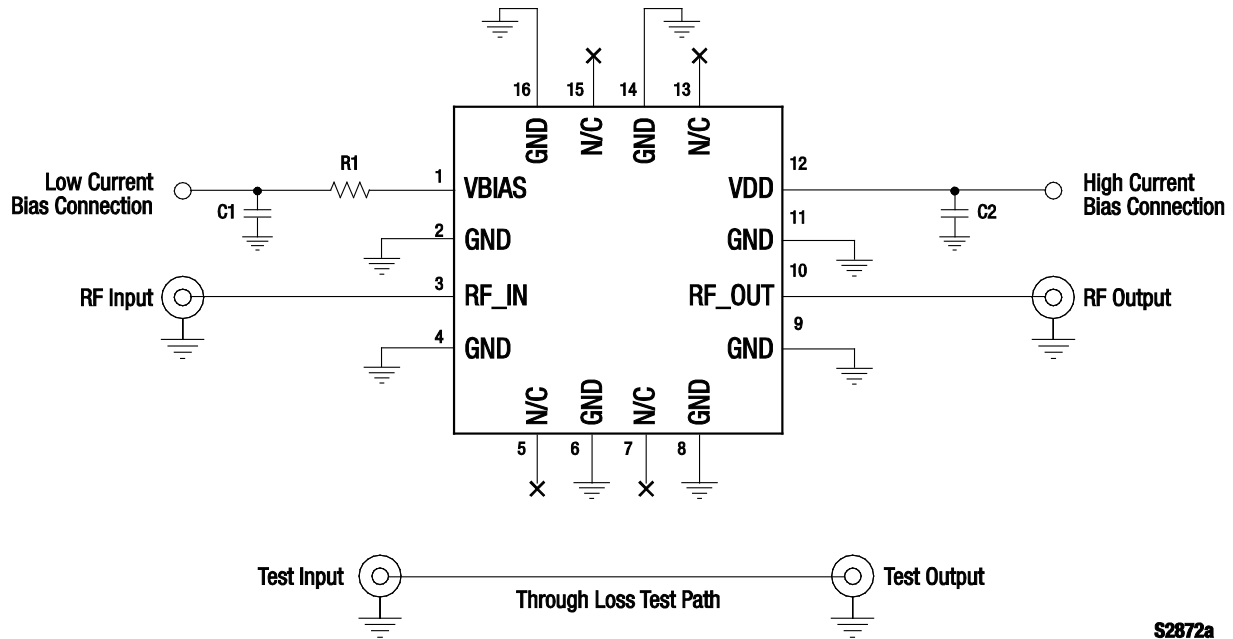

S2872a

Figure 24. SKY67215-11 Schematic Diagram

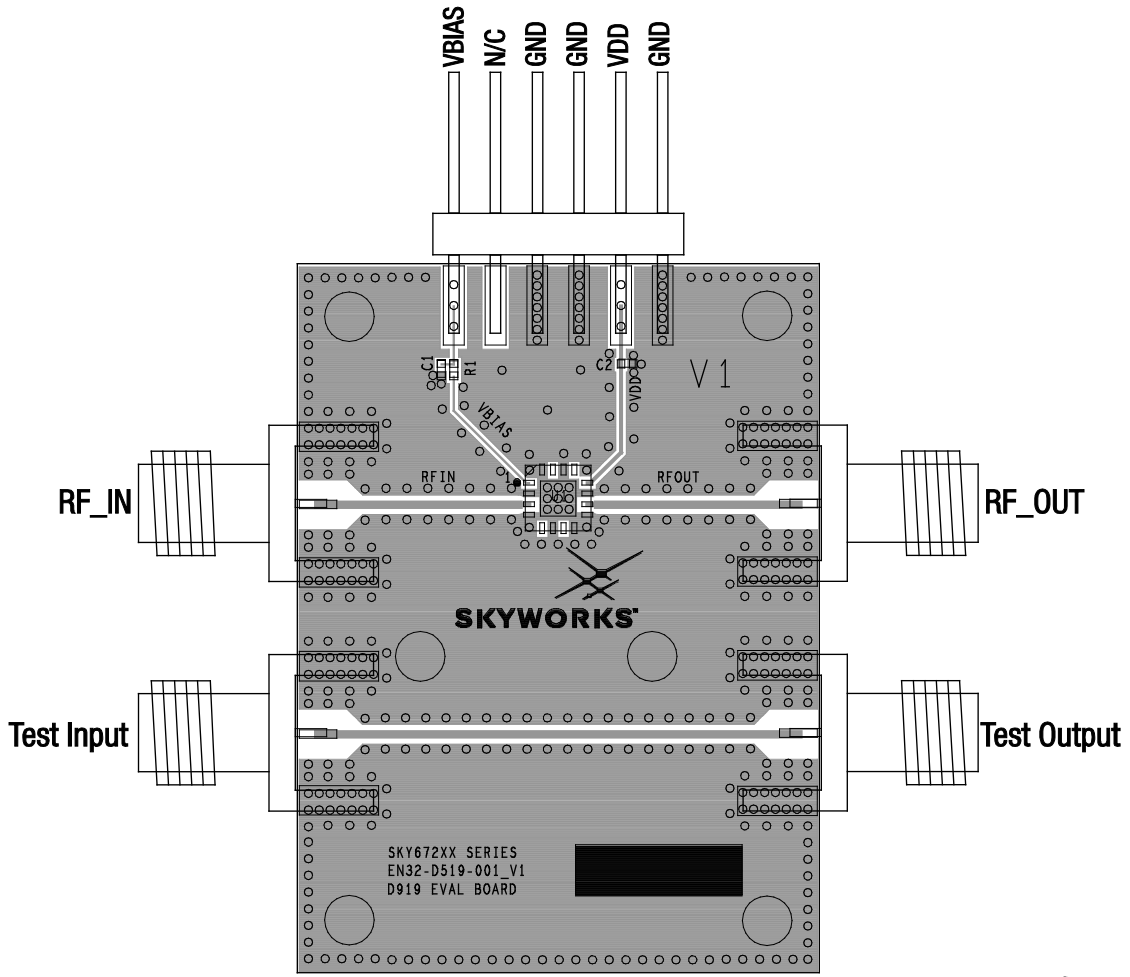

S2854

Figure 25. SKY67215-11 Evaluation Board Assembly Drawing

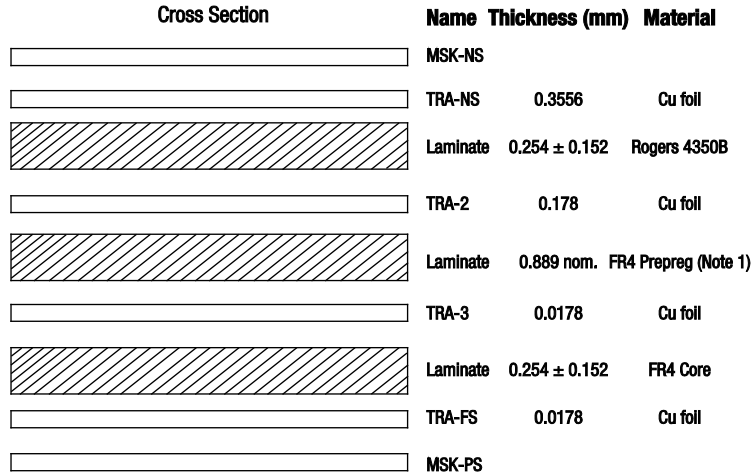

Note 1: Adjust this thickness to meet total thickness goal.

General Notes:

Material: Rogers R04350, $\epsilon_r = 3.66$
 Layer 1 thickness: 0.254 mm
 Overall board thickness: 1.575 mm
 50 Ω transmission line width: 0.522 mm
 Coplanar ground spacing: 1.575 mm
 Via diameter: 0.254 mm

S2574

Figure 26. Layer Detail Physical Characteristics

Table 6. SKY67215-11 Evaluation Board Bill of Materials

Component	Size	Value	Vendor	Part Number
C1		DNI		
C2		DNI		
R1 for 75 mA operation (Note 1)	0402	7500 Ω	Panasonic	

Note 1: Placement in relation to component package is not critical.

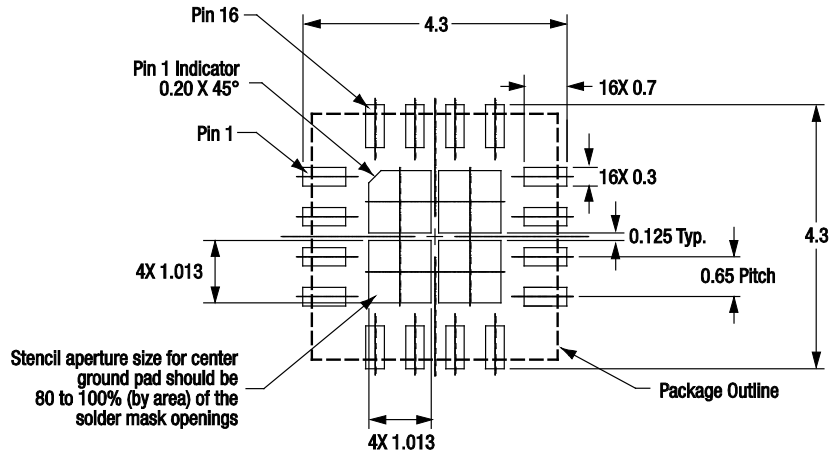

Stencil Aperture Top View

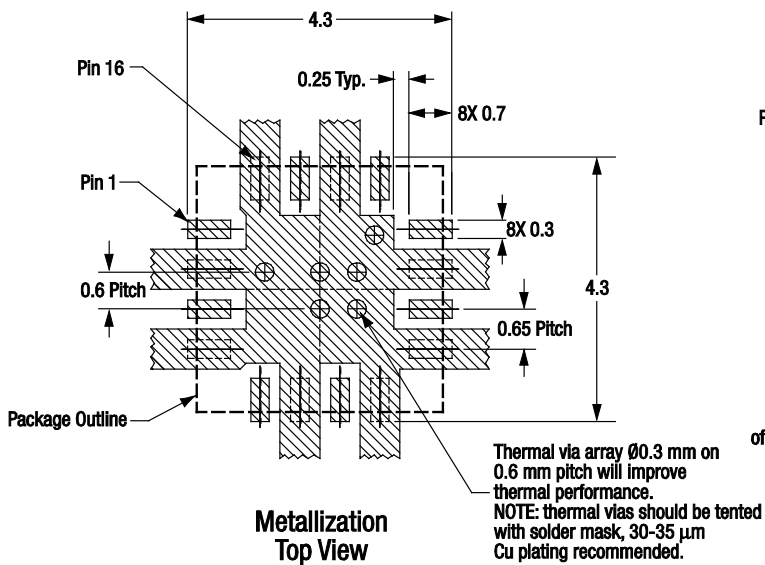

Metallization Top View

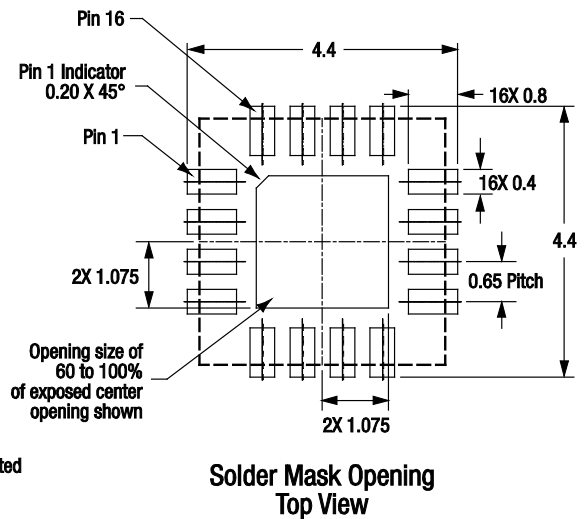

Solder Mask Opening Top View

All dimensions are in millimeters

S2869

Figure 27. SKY67215-11 PCB Layout Footprint

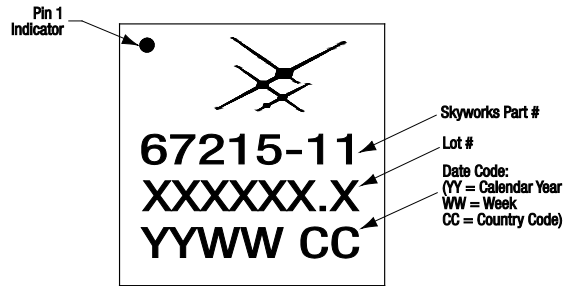

Figure 28. Typical Part Markings (Top View)

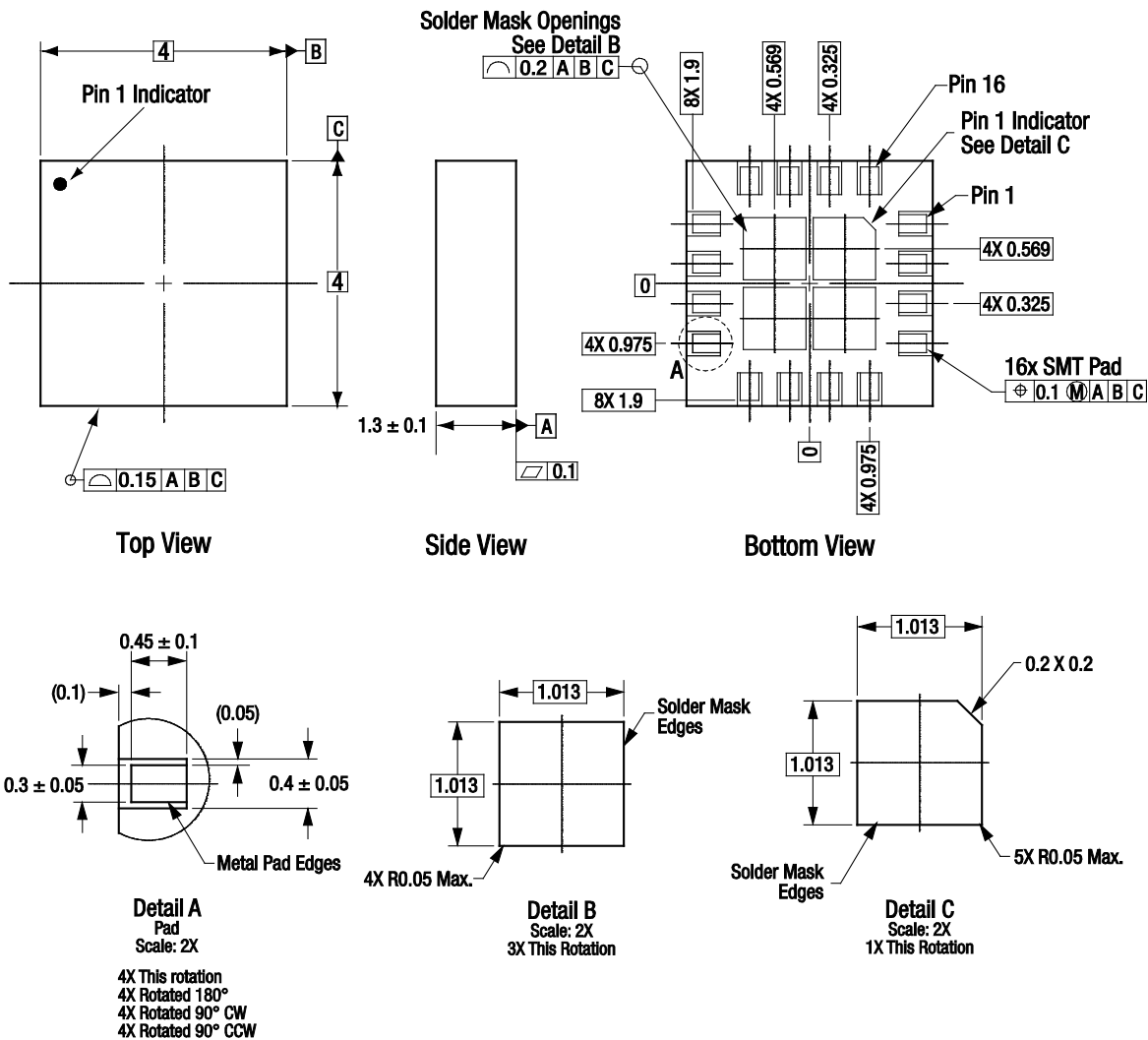
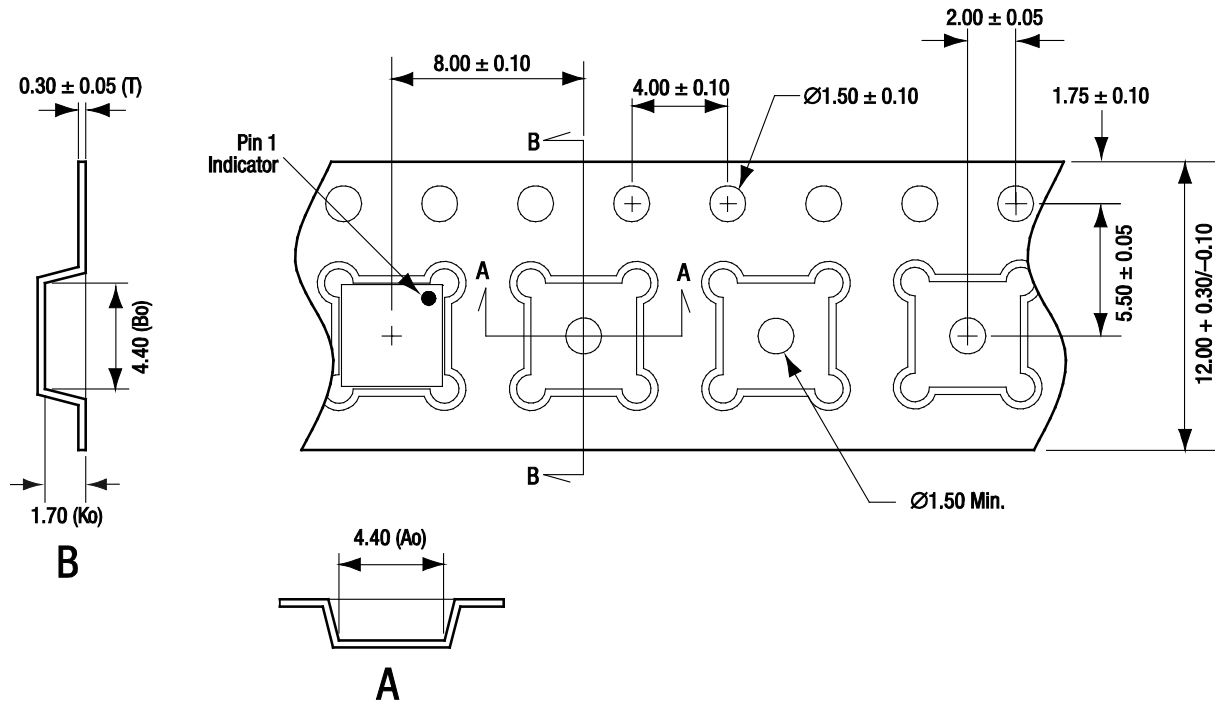

Figure 29. SKY67215-11 16-Pin MCM Package Dimensions

All measurements are in millimeters

Dimensioning and tolerancing according to ASME Y14.5M-1994

S2870



Notes:

1. Carrier tape material: black conductive polycarbonate or polystyrene.
2. Cover tape material: transparent conductive PSA.
3. Cover tape size: 9.3 mm width.
4. Ten sprocket hole pitch cumulative tolerance: ± 0.20 mm.
5. Ao and Bo measured on plane 0.30 mm above the bottom of the pocket.
6. Typical ESD surface resistivity is $\leq 1 \times 10^{10}$ Ohms/square per EIA, JEDEC tape and reel specification.
7. All measurements are in millimeters

S2031

Figure 30. SKY67215-11 Tape and Reel Dimensions

Ordering Information

Model Name	Manufacturing Part Number	Evaluation Board Part Number
SKY67215-11 400-700 MHz LNA	SKY67215-11	SKY67215-11-EVB

Copyright © 2012 Skyworks Solutions, Inc. All Rights Reserved.

Information in this document is provided in connection with Skyworks Solutions, Inc. ("Skyworks") products or services. These materials, including the information contained herein, are provided by Skyworks as a service to its customers and may be used for informational purposes only by the customer. Skyworks assumes no responsibility for errors or omissions in these materials or the information contained herein. Skyworks may change its documentation, products, services, specifications or product descriptions at any time, without notice. Skyworks makes no commitment to update the materials or information and shall have no responsibility whatsoever for conflicts, incompatibilities, or other difficulties arising from any future changes.

No license, whether express, implied, by estoppel or otherwise, is granted to any intellectual property rights by this document. Skyworks assumes no liability for any materials, products or information provided hereunder, including the sale, distribution, reproduction or use of Skyworks products, information or materials, except as may be provided in Skyworks Terms and Conditions of Sale.

THE MATERIALS, PRODUCTS AND INFORMATION ARE PROVIDED "AS IS" WITHOUT WARRANTY OF ANY KIND, WHETHER EXPRESS, IMPLIED, STATUTORY, OR OTHERWISE, INCLUDING FITNESS FOR A PARTICULAR PURPOSE OR USE, MERCHANTABILITY, PERFORMANCE, QUALITY OR NON-INFRINGEMENT OF ANY INTELLECTUAL PROPERTY RIGHT; ALL SUCH WARRANTIES ARE HEREBY EXPRESSLY DISCLAIMED. SKYWORKS DOES NOT WARRANT THE ACCURACY OR COMPLETENESS OF THE INFORMATION, TEXT, GRAPHICS OR OTHER ITEMS CONTAINED WITHIN THESE MATERIALS. SKYWORKS SHALL NOT BE LIABLE FOR ANY DAMAGES, INCLUDING BUT NOT LIMITED TO ANY SPECIAL, INDIRECT, INCIDENTAL, STATUTORY, OR CONSEQUENTIAL DAMAGES, INCLUDING WITHOUT LIMITATION, LOST REVENUES OR LOST PROFITS THAT MAY RESULT FROM THE USE OF THE MATERIALS OR INFORMATION, WHETHER OR NOT THE RECIPIENT OF MATERIALS HAS BEEN ADVISED OF THE POSSIBILITY OF SUCH DAMAGE.

Skyworks products are not intended for use in medical, lifesaving or life-sustaining applications, or other equipment in which the failure of the Skyworks products could lead to personal injury, death, physical or environmental damage. Skyworks customers using or selling Skyworks products for use in such applications do so at their own risk and agree to fully indemnify Skyworks for any damages resulting from such improper use or sale.

Customers are responsible for their products and applications using Skyworks products, which may deviate from published specifications as a result of design defects, errors, or operation of products outside of published parameters or design specifications. Customers should include design and operating safeguards to minimize these and other risks. Skyworks assumes no liability for applications assistance, customer product design, or damage to any equipment resulting from the use of Skyworks products outside of stated published specifications or parameters.

Skyworks, the Skyworks symbol, and "Breakthrough Simplicity" are trademarks or registered trademarks of Skyworks Solutions, Inc., in the United States and other countries. Third-party brands and names are for identification purposes only, and are the property of their respective owners. Additional information, including relevant terms and conditions, posted at www.skyworksinc.com, are incorporated by reference.