

# LM4960

*LM4960 Piezoelectric Speaker Driver*



Literature Number: SNAS221A

[www.BDTIC.com/TI](http://www.BDTIC.com/TI)

# LM4960 Boomer® Audio Power Amplifier Series

## Piezoelectric Speaker Driver

### General Description

The LM4960 utilizes a switching regulator to drive a dual audio power amplifier. It delivers 24V<sub>P-P</sub> mono-BTL to a ceramic speaker with less than 1.0% THD+N while operating on a 3.0V power supply.

The LM4960's switching regulator is a current-mode boost converter operating at a fixed frequency of 1.6MHz.

Boomer audio power amplifiers were designed specifically to provide high quality output power with a minimal amount of external components. The LM4960 does not require output coupling capacitors or bootstrap capacitors, and therefore is ideally suited for mobile phone and other low voltage applications where minimal power consumption is a primary requirement.

The LM4960 features a low-power consumption externally controlled micropower shutdown mode. Additionally, the LM4960 features an internal thermal shutdown protection mechanism along with a short circuit protection.

The LM4960 is unity-gain stable and can be configured by external gain-setting resistors.

### Key Specifications

- V<sub>OUT</sub> @ V<sub>DD</sub> = 3.0 THD+N ≤ 1%
- Power supply range
- Switching Frequency

24V<sub>P-P</sub> (typ)  
3.0 to 7V  
1.6MHz (typ)

### Features

- Low current shutdown mode
- "Click and pop" suppression circuitry
- Low Quiescent current
- Unity-gain stable audio amplifiers
- External gain configuration capability
- Thermal shutdown protection circuitry
- Wide input voltage range (3.0V - 7V)
- 1.6MHz switching frequency

### Applications

- Mobile phone
- PDA's

### Connection Diagram

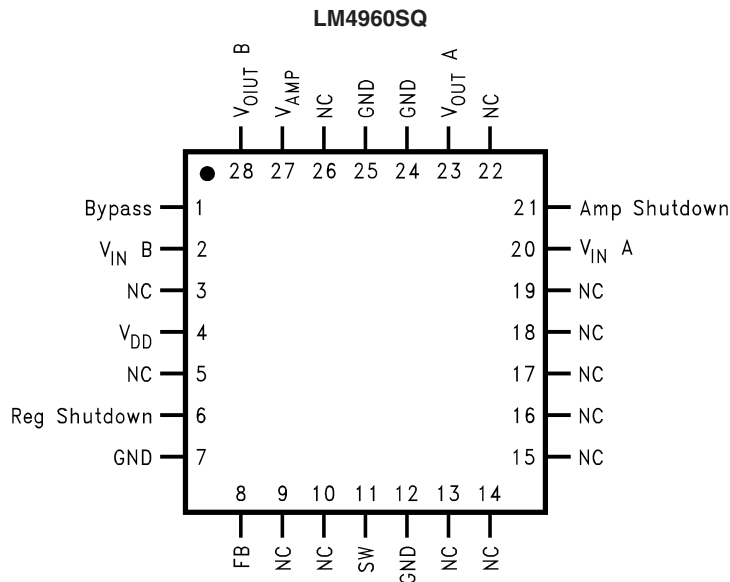

Top View  
Order Number LM4960SQ  
See NS Package Number

20076582

Boomer® is a registered trademark of National Semiconductor Corporation.

## Typical Application

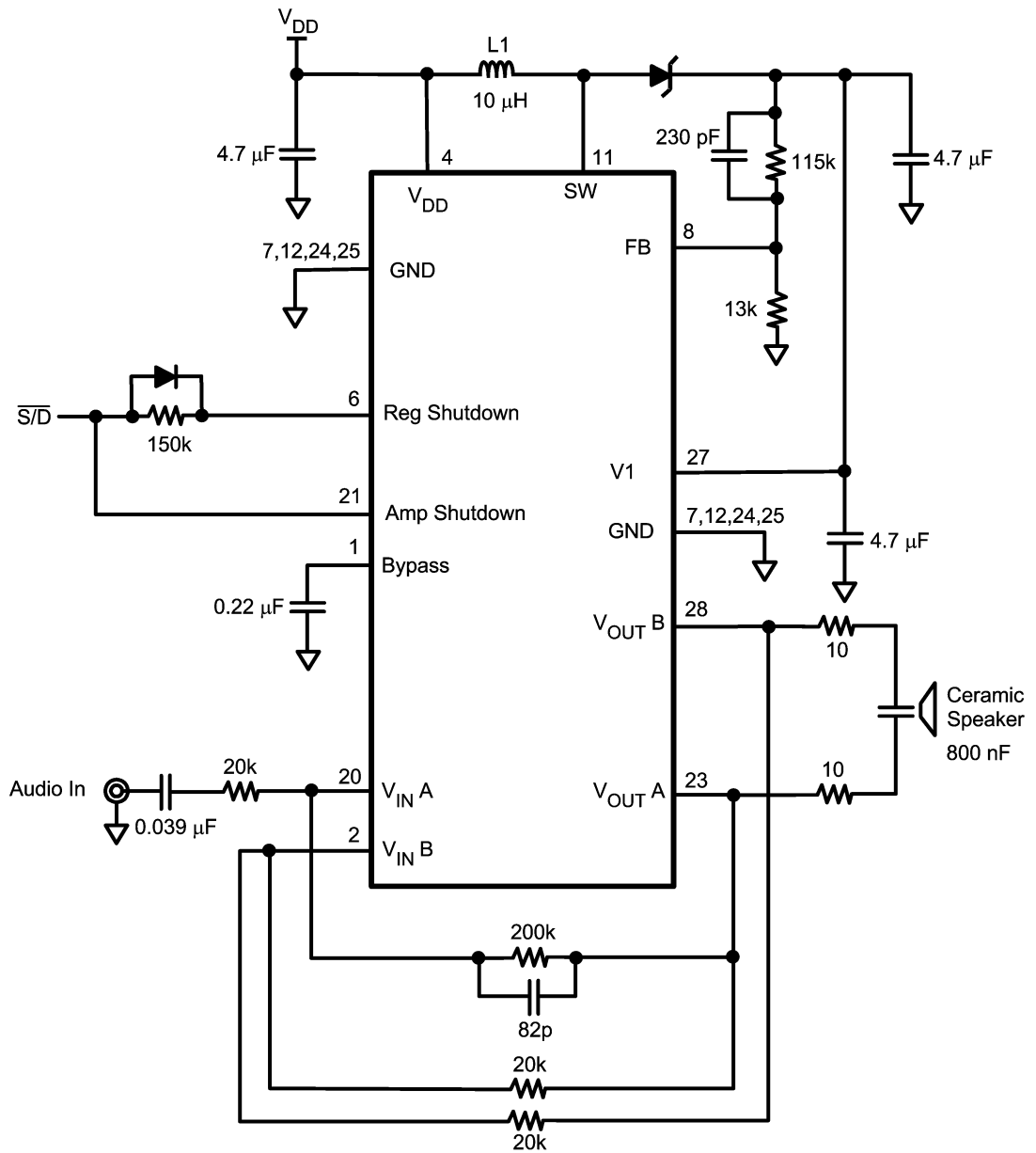

20076581

FIGURE 1. Typical Audio Amplifier Application Circuit

**Absolute Maximum Ratings** (Notes 1, 2)

If Military/Aerospace specified devices are required, please contact the National Semiconductor Sales Office/Distributors for availability and specifications.

Supply Voltage ( $V_{DD}$ )	8.5V
Supply Voltage ( $V_1$ ) (Pin 27 referred to GND)	18V
Storage Temperature	-65°C to +150°C
Input Voltage	-0.3V to $V_{DD} + 0.3V$
Power Dissipation (Note 3)	Internally limited
ESD Susceptibility (Note 4)	2000V
ESD Susceptibility (Note 5)	200V

Junction Temperature	150°C
Thermal Resistance	
$\theta_{JA}$ (LLP)	°C/W
See AN-1187 'Leadless Leadframe Packaging (LLP).'	

**Operating Ratings**

Temperature Range	$T_{MIN} \leq T_A \leq T_{MAX}$	-40°C ≤ $T_A$ ≤ +85°C
Supply Voltage ( $V_{DD}$ )		3.0V ≤ $V_{DD}$ ≤ 7V
Supply Voltage ( $V_1$ )		9.6V ≤ $V_1$ ≤ 16V

**Electrical Characteristics  $V_{DD} = 3.0V$**  (Notes 1, 2)

The following specifications apply for  $V_{DD} = 3V$ ,  $A_V = 10$ ,  $R_L = 800nF + 20\Omega$ ,  $V_1 = 12V$  unless otherwise specified. Limits apply for  $T_A = 25^\circ C$ .

Symbol	Parameter	Conditions	LM4960		Units (Limits)
			Typical (Note 6)	Limit (Notes 7, 8)	
$I_{DD}$	Quiescent Power Supply Current	$V_{IN} = GND$ , No Load	85	150	mA (max)
$I_{SD}$	Shutdown Current	$V_{SHUTDOWN} = GND$ (Note 9)	30	100	µA (max)
$V_{OS}$	Output Offset Voltage		5	40	mV (max)
$V_{SDIH}$	Shutdown Voltage Input High			2	V (max)
$V_{SDIL}$	Shutdown Voltage Input Low			0.4	V (min)
$T_{WU}$	Wake-up Time	$C_B = 0.22\mu F$	50		ms
TSD	Thermal Shutdown Temperature		170	150 190	°C (min) °C (max)
$V_O$	Output Voltage	THD = 1% (max); $f = 1kHz$	24	20	$V_{P-P}$ (min)
THD+N	Total Harmonic Distortion + Noise	$V_O = 3W_{rms}$ ; $f = 1kHz$	0.04		%
$\epsilon_{OS}$	Output Noise	A-Weighted Filter, $V_{IN} = 0V$	90		µV
PSRR	Power Supply Rejection Ratio	$V_{RIPPLE} = 200mV_{P-P}$ ; $f = 1kHz$	55	50	dB (min)
$V_{FB}$	Feedback Pin Reference Voltage		1.23		V (max)

**Electrical Characteristics  $V_{DD} = 5.0V$**  (Notes 1, 2)

The following specifications apply for  $V_{DD} = 5V$ ,  $A_V = 10$ ,  $R_L = 800nF + 20\Omega$  unless otherwise specified. Limits apply for  $T_A = 25^\circ C$ .

Symbol	Parameter	Conditions	LM4960		Units (Limits)
			Typical (Note 6)	Limit (Notes 7, 8)	
$I_{DD}$	Quiescent Power Supply Current	$V_{IN} = GND$ , No Load	45		mA (max)
$I_{SD}$	Shutdown Current	$V_{SHUTDOWN} = GND$ (Note 9)	55	100	µA (max)
$V_{SDIH}$	Shutdown Voltage Input High			2	V (max)
$V_{SDIL}$	Shutdown Voltage Input Low			0.4	V (min)
$T_{WU}$	Wake-up Time	$C_B = 0.22\mu F$	50		s
TSD	Thermal Shutdown Temperature		170	150 190	°C (min) °C (max)
$V_O$	Output Voltage	THD = 1% (max); $f = 1kHz$ $R_L = \text{Ceramic Speaker}$	24	20	$V_{P-P}$ (min)
THD+N	Total Harmonic Distortion + Noise	$V_O = 3W_{rms}$ ; $f = 1kHz$	0.04		%
$\epsilon_{OS}$	Output Noise	A-Weighted Filter, $V_{IN} = 0V$	90		µV
PSRR	Power Supply Rejection Ratio	$V_{RIPPLE} = 200mV_{P-P}$ ; $f = 1kHz$	60		dB (min)
$V_{FB}$	Feedback Pin Reference Voltage		1.23		V (max)

**Note 1:** All voltages are measured with respect to the GND pin, unless otherwise specified.

## Electrical Characteristics $V_{DD} = 5.0V$ (Notes 1, 2) (Continued)

**Note 2:** *Absolute Maximum Ratings* indicate limits beyond which damage to the device may occur. *Operating Ratings* indicate conditions for which the device is functional, but do not guarantee specific performance limits. *Electrical Characteristics* state DC and AC electrical specifications under particular test conditions which guarantee specific performance limits. This assumes that the device is within the Operating Ratings. Specifications are not guaranteed for parameters where no limit is given, however, the typical value is a good indication of device performance.

**Note 3:** The maximum power dissipation must be derated at elevated temperatures and is dictated by  $T_{JMAX}$ ,  $\theta_{JA}$ , and the ambient temperature,  $T_A$ . The maximum allowable power dissipation is  $P_{DMAX} = (T_{JMAX} - T_A) / \theta_{JA}$  or the given in Absolute Maximum Ratings, whichever is lower. For the LM4960 typical application (shown in *Figure 1*) with  $V_{DD} = 12V$ ,  $R_L = 4\Omega$  stereo operation the total power dissipation is 3.65W.  $\theta_{JA} = 35^\circ C/W$ .

**Note 4:** Human body model, 100pF discharged through a 1.5k $\Omega$  resistor.

**Note 5:** Machine Model, 220pF–240pF discharged through all pins.

**Note 6:** Typicals are measured at 25°C and represent the parametric norm.

**Note 7:** Limits are guaranteed to National's AOQL (Average Outgoing Quality Level).

**Note 8:** Datasheet min/max specification limits are guaranteed by design, test, or statistical analysis.

**Note 9:** Shutdown current is measured in a normal room environment. The Shutdown pin should be driven as close as possible to  $V_{DD}$  for minimum shutdown current.

# Typical Performance Characteristics

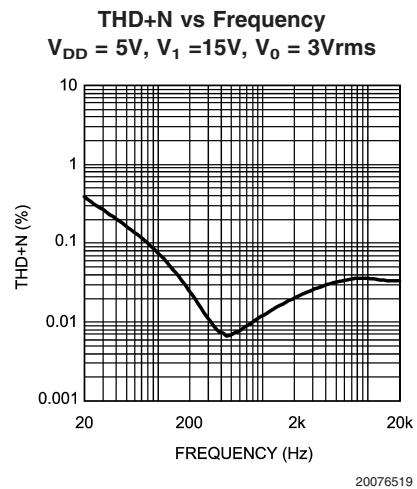
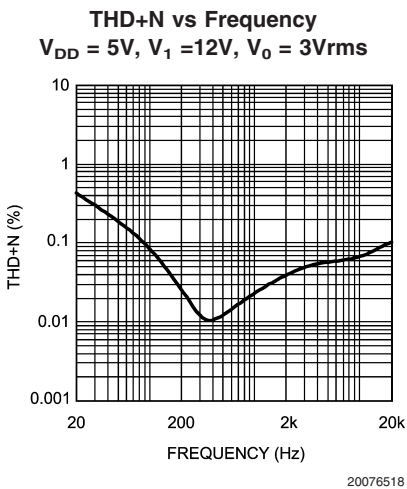
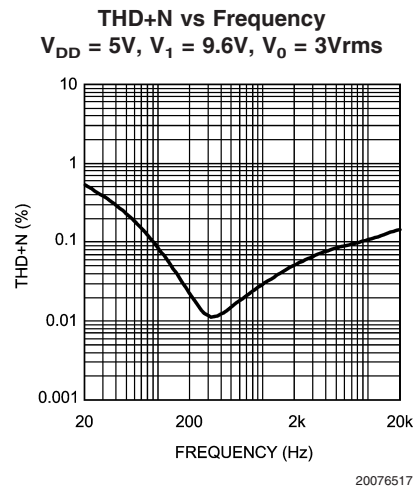
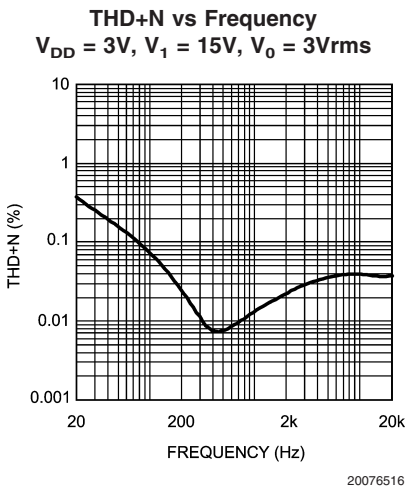
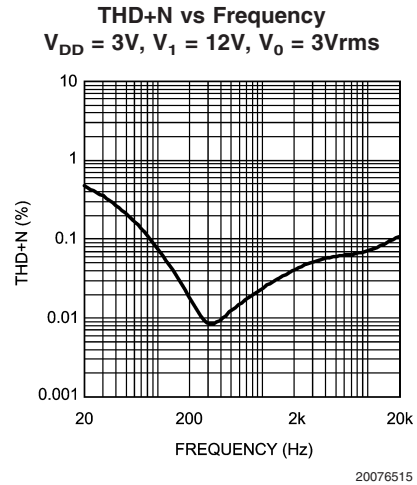
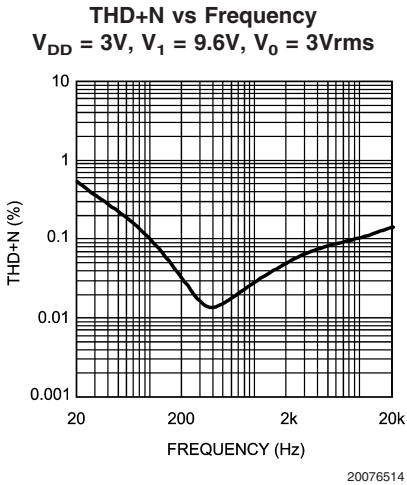

## Typical Performance Characteristics (Continued)

**THD+N vs Output Power**

$V_{DD} = 3V$ ,  $V_1 = 9.6V$ ,  
 $f = 100Hz, 1kHz, 10kHz$

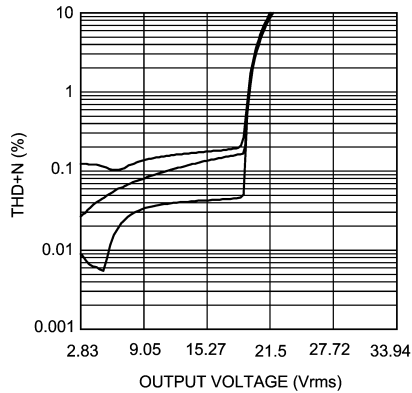

**THD+N vs Output Power**

$V_{DD} = 3V$ ,  $V_1 = 12V$ ,  
 $f = 100Hz, 1kHz, 10kHz$

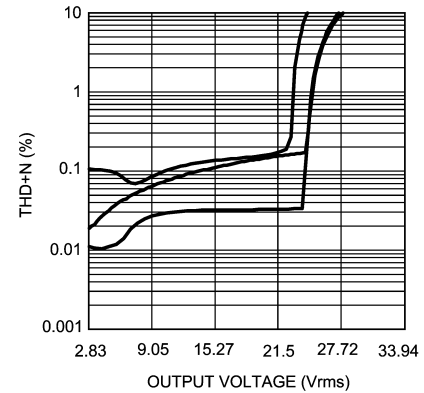

**THD+N vs Output Power**

$V_{DD} = 3V$ ,  $V_1 = 15V$ ,  
 $f = 100Hz, 1kHz, 10kHz$

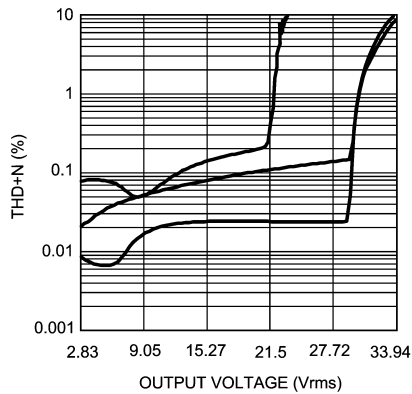

**THD+N vs Output Power**

$V_{DD} = 5V$ ,  $V_1 = 9.6V$ ,  
 $f = 100Hz, 1kHz, 10kHz$

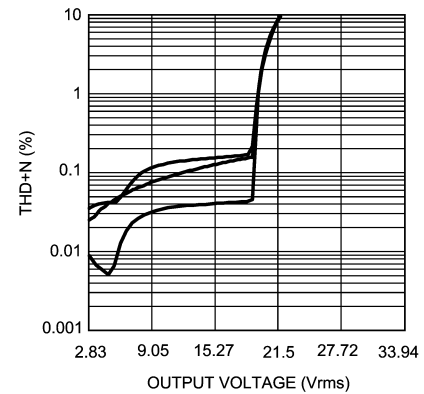

**THD+N vs Output Power**

$V_{DD} = 5V$ ,  $V_1 = 12V$ ,  
 $f = 100Hz, 1kHz, 10kHz$

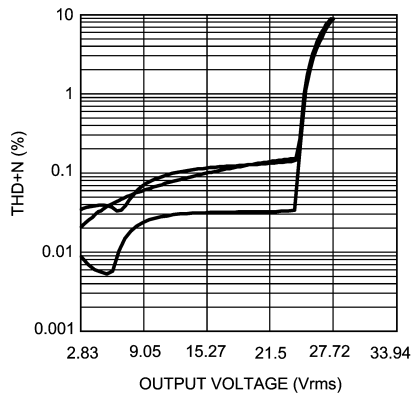

**THD+N vs Output Power**

$V_{DD} = 5V$ ,  $V_1 = 15V$ ,  
 $f = 100Hz, 1kHz, 10kHz$

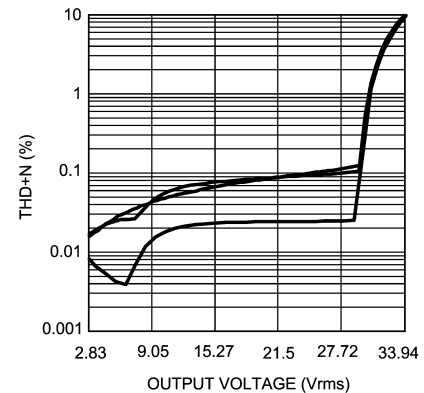

# Typical Performance Characteristics (Continued)

## Power Dissipation vs Output Voltage

$V_{DD} = 3V$ , from top to bottom:  
 $V_1 = 15V$ ,  $V_1 = 12V$ ,  $V_1 = 9.6V$

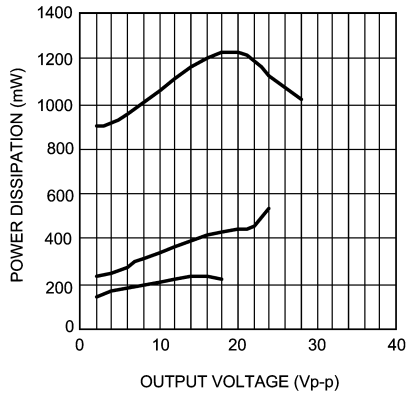

20076509

## Power Dissipation vs Output Voltage

$V_{DD} = 5V$ , from top to bottom:  
 $V_1 = 15V$ ,  $V_1 = 12V$ ,  $V_1 = 9.6V$

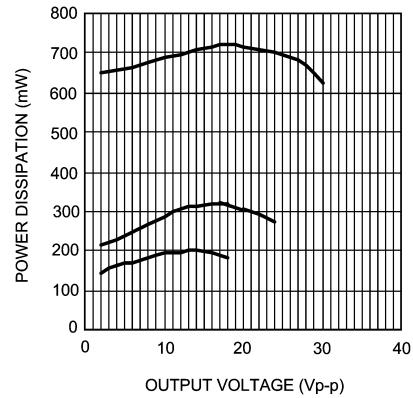

20076510

## Supply Current vs Supply Voltage

from top to bottom:  
 $V_{DD} = 15V$ ,  $V_{DD} = 12V$ ,  $V_{DD} = 9.6V$

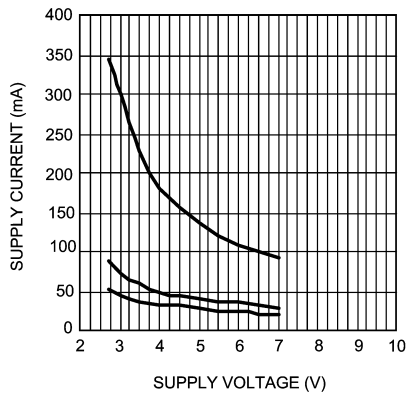

20076513

## Power Supply Rejection Ratio

$V_{DD} = 3V$

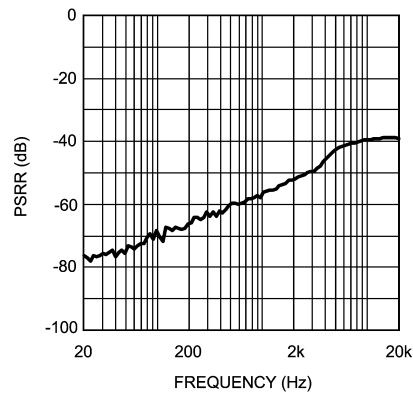

20076511

## Power Supply Rejection Ratio

$V_{DD} = 5V$

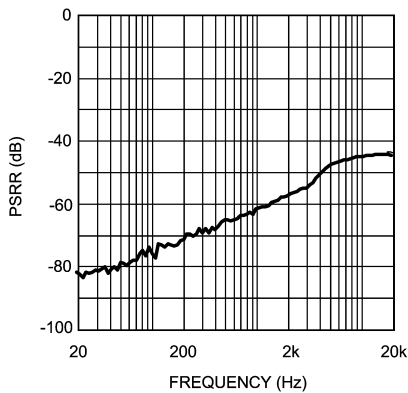

20076512



## Application Information

### BRIDGE CONFIGURATION EXPLANATION

The Audio Amplifier portion of the LM4960 has two internal amplifiers allowing different amplifier configurations. The first amplifier's gain is externally configurable, whereas the second amplifier is internally fixed in a unity-gain, inverting configuration. The closed-loop gain of the first amplifier is set by selecting the ratio of Rf to Ri while the second amplifier's gain is fixed by the two internal 20kΩ resistors. Figure 1 shows that the output of amplifier one serves as the input to amplifier two. This results in both amplifiers producing signals identical in magnitude, but out of phase by 180°. Consequently, the differential gain for the Audio Amplifier is

$$A_{VD} = 2 * (Rf/Ri)$$

By driving the load differentially through outputs Vo1 and Vo2, an amplifier configuration commonly referred to as "bridged mode" is established. Bridged mode operation is different from the classic single-ended amplifier configuration where one side of the load is connected to ground.

A bridge amplifier design has a few distinct advantages over the single-ended configuration. It provides differential drive to the load, thus doubling the output swing for a specified supply voltage. Four times the output power is possible as compared to a single-ended amplifier under the same conditions. This increase in attainable output power assumes that the amplifier is not current limited or clipped. In order to choose an amplifier's closed-loop gain without causing excessive clipping, please refer to the **Audio Power Amplifier Design** section.

The bridge configuration also creates a second advantage over single-ended amplifiers. Since the differential outputs, Vo1 and Vo2, are biased at half-supply, no net DC voltage exists across the load. This eliminates the need for an output coupling capacitor which is required in a single supply, single-ended amplifier configuration. Without an output coupling capacitor, the half-supply bias across the load would result in both increased internal IC power dissipation and also possible loudspeaker damage.

### AMPLIFIER POWER DISSIPATION

Power dissipation is a major concern when designing a successful amplifier, whether the amplifier is bridged or single-ended. A direct consequence of the increased power delivered to the load by a bridge amplifier is an increase in internal power dissipation. Since the amplifier portion of the LM4960 has two operational amplifiers, the maximum internal power dissipation is 4 times that of a single-ended amplifier. The maximum power dissipation for a given BTL application can be derived from Equation 1.

$$P_{DMAX(AMP)} = 4(V_{DD})^2 / (2\pi^2 Z_L) \quad (1)$$

where

$$Z_L = R_{o1} + R_{o2} + 1/2\pi f c$$

### BOOST CONVERTER POWER DISSIPATION

At higher duty cycles, the increased ON-time of the switch FET means the maximum output current will be determined by power dissipation within the LM2731 FET switch. The switch power dissipation from ON-time conduction is calculated by Equation 2.

$$P_{DMAX(SWITCH)} = DC \times I_{IND(AVE)}^2 \times R_{DS(ON)} \quad (2)$$

where DC is the duty cycle.

There will be some switching losses as well, so some derating needs to be applied when calculating IC power dissipation.

### TOTAL POWER DISSIPATION

The total power dissipation for the LM4960 can be calculated by adding Equation 1 and Equation 2 together to establish Equation 3:

$$P_{DMAX(TOTAL)} = [4*(V_{DD})^2/2\pi^2 Z_L] + [DC \times I_{IND(AVE)}^2 \times R_{DS(ON)}] \quad (3)$$

The result from Equation 3 must not be greater than the power dissipation that results from Equation 4:

$$P_{DMAX} = (T_{JMAX} - T_A) / \theta_{JA} \quad (4)$$

For the LQA28A,  $\theta_{JA} = 59^\circ\text{C/W}$ .  $T_{JMAX} = 125^\circ\text{C}$  for the LM4960. Depending on the ambient temperature,  $T_A$ , of the system surroundings, Equation 4 can be used to find the maximum internal power dissipation supported by the IC packaging. If the result of Equation 3 is greater than that of Equation 4, then either the supply voltage must be increased, the load impedance increased or  $T_A$  reduced. For the typical application of a 3V power supply, with V1 set to 12V and a 800nF + 20Ω load, the maximum ambient temperature possible without violating the maximum junction temperature is approximately 118°C provided that device operation is around the maximum power dissipation point. Thus, for typical applications, power dissipation is not an issue. Power dissipation is a function of output power and thus, if typical operation is not around the maximum power dissipation point, the ambient temperature may be increased accordingly. Refer to the Typical Performance Characteristics curves for power dissipation information for lower output levels.

### EXPOSED-DAP PACKAGE PCB MOUNTING CONSIDERATIONS

The LM4960's exposed-DAP (die attach paddle) package (LD) provides a low thermal resistance between the die and the PCB to which the part is mounted and soldered. The low thermal resistance allows rapid heat transfer from the die to the surrounding PCB copper traces, ground plane, and surrounding air. The LD package should have its DAP soldered to a copper pad on the PCB. The DAP's PCB copper pad may be connected to a large plane of continuous unbroken copper. This plane forms a thermal mass, heat sink, and radiation area. Further detailed and specific information concerning PCB layout, fabrication, and mounting an LD (LLP) package is found in National Semiconductor's Package Engineering Group under application note AN1187.

## Application Information (Continued)

### SHUTDOWN FUNCTION

In many applications, a microcontroller or microprocessor output is used to control the shutdown circuitry to provide a quick, smooth transition into shutdown. Another solution is to use a single-pole, single-throw switch, and a pull-up resistor. One terminal of the switch is connected to GND. The other side is connected to the two shutdown pins and the terminal of the pull-up resistor. The remaining resistance terminal is connected to  $V_{DD}$ . If the switch is open, then the external pull-up resistor connected to  $V_{DD}$  will enable the LM4960. This scheme guarantees that the shutdown pins will not float thus preventing unwanted state changes.

### PROPER SELECTION OF EXTERNAL COMPONENTS

Proper selection of external components in applications using integrated power amplifiers, and switching DC-DC converters, is critical for optimizing device and system performance. Consideration to component values must be used to maximize overall system quality.

The best capacitors for use with the switching converter portion of the LM4960 are multi-layer ceramic capacitors. They have the lowest ESR (equivalent series resistance) and highest resonance frequency, which makes them optimum for high frequency switching converters.

When selecting a ceramic capacitor, only X5R and X7R dielectric types should be used. Other types such as Z5U and Y5F have such severe loss of capacitance due to effects of temperature variation and applied voltage, they may provide as little as 20% of rated capacitance in many typical applications. Always consult capacitor manufacturer's data curves before selecting a capacitor. High-quality ceramic capacitors can be obtained from Taiyo-Yuden, AVX, and Murata.

### POWER SUPPLY BYPASSING

As with any amplifier, proper supply bypassing is critical for low noise performance and high power supply rejection. The capacitor location on both  $V_1$  and  $V_{DD}$  pins should be as close to the device as possible.

### SELECTING INPUT CAPACITOR FOR AUDIO AMPLIFIER

One of the major considerations is the closed-loop bandwidth of the amplifier. To a large extent, the bandwidth is dictated by the choice of external components shown in Figure 1. The input coupling capacitor,  $C_i$ , forms a first order high pass filter which limits low frequency response. This value should be chosen based on needed frequency response for a few distinct reasons.

High value input capacitors are both expensive and space hungry in portable designs. Clearly, a certain value capacitor is needed to couple in low frequencies without severe attenuation. But ceramic speakers used in portable systems, whether internal or external, have little ability to reproduce signals below 100Hz to 150Hz. Thus, using a high value input capacitor may not increase actual system performance.

In addition to system cost and size, click and pop performance is affected by the value of the input coupling capacitor,  $C_i$ . A high value input coupling capacitor requires more charge to reach its quiescent DC voltage (nominally  $1/2 V_{DD}$ ). This charge comes from the output via the feedback

and is apt to create pops upon device enable. Thus, by minimizing the capacitor value based on desired low frequency response, turn-on pops can be minimized.

### SELECTING BYPASS CAPACITOR FOR AUDIO AMPLIFIER

Besides minimizing the input capacitor value, careful consideration should be paid to the bypass capacitor value. Bypass capacitor,  $C_B$ , is the most critical component to minimize turn-on pops since it determines how fast the amplifier turns on. The slower the amplifier's outputs ramp to their quiescent DC voltage (nominally  $1/2 V_{DD}$ ), the smaller the turn-on pop. Choosing  $C_B$  equal to  $1.0\mu\text{F}$  along with a small value of  $C_i$  (in the range of  $0.039\mu\text{F}$  to  $0.39\mu\text{F}$ ), should produce a virtually clickless and popless shutdown function. Although the device will function properly, (no oscillations or motor-boating), with  $C_B$  equal to  $0.1\mu\text{F}$ , the device will be much more susceptible to turn-on clicks and pops. Thus, a value of  $C_B$  equal to  $1.0\mu\text{F}$  is recommended in all but the most cost sensitive designs.

### SELECTING FEEDBACK CAPACITOR FOR AUDIO AMPLIFIER

The LM4960 is unity-gain stable which gives the designer maximum system flexibility. However, to drive ceramic speakers, a typical application requires a closed-loop differential gain of 10. In this case a feedback capacitor ( $C_f$ ) will be needed as shown in Figure 2 to bandwidth limit the amplifier.

This feedback capacitor creates a low pass filter that eliminates possible high frequency oscillations. Care should be taken when calculating the -3dB frequency because an incorrect combination of  $R_f$  and  $C_f$  will cause rolloff before the desired frequency

### SELECTING OUTPUT CAPACITOR ( $C_o$ ) FOR BOOST CONVERTER

A single  $4.7\mu\text{F}$  to  $10\mu\text{F}$  ceramic capacitor will provide sufficient output capacitance for most applications. If larger amounts of capacitance are desired for improved line support and transient response, tantalum capacitors can be used. Aluminum electrolytics with ultra low ESR such as Sanyo Oscon can be used, but are usually prohibitively expensive. Typical Al electrolytic capacitors are not suitable for switching frequencies above 500 kHz because of significant ringing and temperature rise due to self-heating from ripple current. An output capacitor with excessive ESR can also reduce phase margin and cause instability.

In general, if electrolytics are used, we recommended that they be paralleled with ceramic capacitors to reduce ringing, switching losses, and output voltage ripple.

### SELECTING INPUT CAPACITOR ( $C_{s1}$ ) FOR BOOST CONVERTER

An input capacitor is required to serve as an energy reservoir for the current which must flow into the coil each time the switch turns ON. This capacitor must have extremely low ESR, so ceramic is the best choice. We recommend a nominal value of  $4.7\mu\text{F}$ , but larger values can be used. Since this capacitor reduces the amount of voltage ripple seen at the input pin, it also reduces the amount of EMI passed back along that line to other circuitry.

## Application Information (Continued)

### SETTING THE OUTPUT VOLTAGE ( $V_1$ ) OF BOOST CONVERTER

The output voltage is set using the external resistors R1 and R2 (see Figure 1). A value of approximately 13.3k $\Omega$  is recommended for R2 to establish a divider current of approximately 92 $\mu$ A. R1 is calculated using the formula:

$$R1 = R2 \times (V_2/1.23 - 1) \quad (5)$$

### FEED-FORWARD COMPENSATION FOR BOOST CONVERTER

Although the LM4960's internal Boost converter is internally compensated, the external feed-forward capacitor  $C_f$  is required for stability (see Figure 1). Adding this capacitor puts a zero in the loop response of the converter. The recommended frequency for the zero  $f_z$  should be approximately 6kHz.  $C_f$  can be calculated using the formula:

$$C_f = 1 / (2 \times R1 \times f_z) \quad (6)$$

### SELECTING DIODES

The external diode used in Figure 1 should be a Schottky diode. A 20V diode such as the MBR0520 is recommended.

The MBR05XX series of diodes are designed to handle a maximum average current of 0.5A. For applications exceeding 0.5A average but less than 1A, a Microsemi UPS5817 can be used.

### DUTY CYCLE

The maximum duty cycle of the boost converter determines the maximum boost ratio of output-to-input voltage that the converter can attain in continuous mode of operation. The duty cycle for a given boost application is defined as:

$$\text{Duty Cycle} = (V_{OUT} + V_{DIODE} - V_{IN}) / (V_{OUT} + V_{DIODE} - V_{SW})$$

This applies for continuous mode operation.

### INDUCTANCE VALUE

The first question we are usually asked is: "How small can I make the inductor." (because they are the largest sized component and usually the most costly). The answer is not simple and involves trade-offs in performance. Larger inductors mean less inductor ripple current, which typically means less output voltage ripple (for a given size of output capacitor). Larger inductors also mean more load power can be delivered because the energy stored during each switching cycle is:

$$E = L/2 \times (I_p)^2$$

Where "I<sub>p</sub>" is the peak inductor current. An important point to observe is that the LM4960 will limit its switch current based on peak current. This means that since I<sub>p</sub>(max) is fixed, increasing L will increase the maximum amount of power available to the load. Conversely, using too little inductance may limit the amount of load current which can be drawn from the output.

Best performance is usually obtained when the converter is operated in "continuous" mode at the load current range of interest, typically giving better load regulation and less output ripple. Continuous operation is defined as not allowing the inductor current to drop to zero during the cycle. It should be noted that all boost converters shift over to discontinuous operation as the output load is reduced far enough, but a larger inductor stays "continuous" over a wider load current range.

To better understand these trade-offs, a typical application circuit (5V to 12V boost with a 10 $\mu$ H inductor) will be analyzed. We will assume:

$$V_{IN} = 5V, V_{OUT} = 12V, V_{DIODE} = 0.5V, V_{SW} = 0.5V$$

Since the frequency is 1.6MHz (nominal), the period is approximately 0.625 $\mu$ s. The duty cycle will be 62.5%, which means the ON-time of the switch is 0.390 $\mu$ s. It should be noted that when the switch is ON, the voltage across the inductor is approximately 4.5V. Using the equation:

$$V = L (di/dt)$$

We can then calculate the di/dt rate of the inductor which is found to be 0.45 A/ $\mu$ s during the ON-time. Using these facts, we can then show what the inductor current will look like during operation:

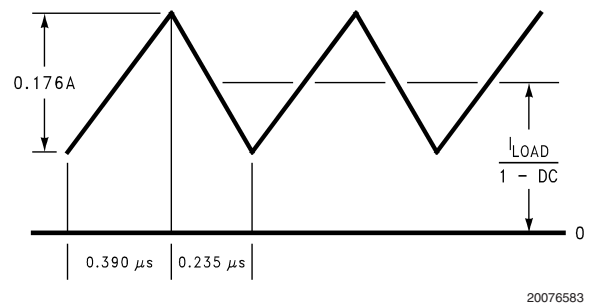

**FIGURE 2. 10 $\mu$ H Inductor Current  
5V - 12V Boost (LM4960)**

During the 0.390 $\mu$ s ON-time, the inductor current ramps up 0.176A and ramps down an equal amount during the OFF-time. This is defined as the inductor "ripple current". It can also be seen that if the load current drops to about 33mA, the inductor current will begin touching the zero axis which means it will be in discontinuous mode. A similar analysis can be performed on any boost converter, to make sure the ripple current is reasonable and continuous operation will be maintained at the typical load current values.

### MAXIMUM SWITCH CURRENT

The maximum FET switch current available before the current limiter cuts in is dependent on duty cycle of the application. This is illustrated in a graph in the typical performance characterization section which shows typical values of switch current as a function of effective (actual) duty cycle.

## Application Information (Continued)

### CALCULATING OUTPUT CURRENT OF BOOST CONVERTER ( $I_{AMP}$ )

As shown in Figure 2 which depicts inductor current, the load current is related to the average inductor current by the relation:

$$I_{LOAD} = I_{IND(AVG)} \times (1 - DC) \quad (7)$$

Where "DC" is the duty cycle of the application. The switch current can be found by:

$$I_{SW} = I_{IND(AVG)} + 1/2 (I^{RIPPLE}) \quad (8)$$

Inductor ripple current is dependent on inductance, duty cycle, input voltage and frequency:

$$I_{RIPPLE} = DC \times (V_{IN} - V_{SW}) / (f \times L) \quad (9)$$

combining all terms, we can develop an expression which allows the maximum available load current to be calculated:

$$I_{LOAD(max)} = (1 - DC) \times (I_{SW(max)} - DC(V_{IN} - V_{SW})) / fL \quad (10)$$

The equation shown to calculate maximum load current takes into account the losses in the inductor or turn-OFF switching losses of the FET and diode.

### DESIGN PARAMETERS $V_{SW}$ AND $I_{SW}$

The value of the FET "ON" voltage (referred to as  $V_{SW}$  in equations 7 thru 10) is dependent on load current. A good approximation can be obtained by multiplying the "ON Resistance" of the FET times the average inductor current.

FET on resistance increases at  $V_{IN}$  values below 5V, since the internal N-FET has less gate voltage in this input voltage range (see Typical Performance Characteristics curves). Above  $V_{IN} = 5V$ , the FET gate voltage is internally clamped to 5V.

The maximum peak switch current the device can deliver is dependent on duty cycle. For higher duty cycles, see Typical Performance Characteristics curves.

### INDUCTOR SUPPLIERS

Recommended suppliers of inductors for the LM4960 include, but are not limited to Taiyo-Yuden, Sumida, Coilcraft, Panasonic, TDK and Murata. When selecting an inductor, make certain that the continuous current rating is high enough to avoid saturation at peak currents. A suitable core type must be used to minimize core (switching) losses, and wire power losses must be considered when selecting the current rating.

### PCB LAYOUT GUIDELINES

High frequency boost converters require very careful layout of components in order to get stable operation and low noise. All components must be as close as possible to the LM4802 device. It is recommended that a 4-layer PCB be used so that internal ground planes are available.

Some additional guidelines to be observed:

1. Keep the path between L1, D1, and Co extremely short. Parasitic trace inductance in series with D1 and Co will increase noise and ringing.
2. The feedback components R1, R2 and  $C_f$  1 must be kept close to the FB pin of U1 to prevent noise injection on the FB pin trace.
3. If internal ground planes are available (recommended) use vias to connect directly to ground at pin 2 of U1, as well as the negative sides of capacitors  $C_{s1}$  and Co.

### GENERAL MIXED-SIGNAL LAYOUT RECOMMENDATION

This section provides practical guidelines for mixed signal PCB layout that involves various digital/analog power and ground traces. Designers should note that these are only "rule-of-thumb" recommendations and the actual results will depend heavily on the final layout.

#### Power and Ground Circuits

For 2 layer mixed signal design, it is important to isolate the digital power and ground trace paths from the analog power and ground trace paths. Star trace routing techniques (bringing individual traces back to a central point rather than daisy chaining traces together in a serial manner) can have a major impact on low level signal performance. Star trace routing refers to using individual traces to feed power and ground to each circuit or even device. This technique will take require a greater amount of design time but will not increase the final price of the board. The only extra parts required may be some jumpers.

#### Single-Point Power / Ground Connection

The analog power traces should be connected to the digital traces through a single point (link). A "Pi-filter" can be helpful in minimizing high frequency noise coupling between the analog and digital sections. It is further recommended to place digital and analog power traces over the corresponding digital and analog ground traces to minimize noise coupling.

#### Placement of Digital and Analog Components

All digital components and high-speed digital signals traces should be located as far away as possible from analog components and circuit traces.

#### Avoiding Typical Design / Layout Problems

Avoid ground loops or running digital and analog traces parallel to each other (side-by-side) on the same PCB layer. When traces must cross over each other do it at 90 degrees. Running digital and analog traces at 90 degrees to each other from the top to the bottom side as much as possible will minimize capacitive noise coupling and crosstalk.

**Physical Dimensions** inches (millimeters) unless otherwise noted

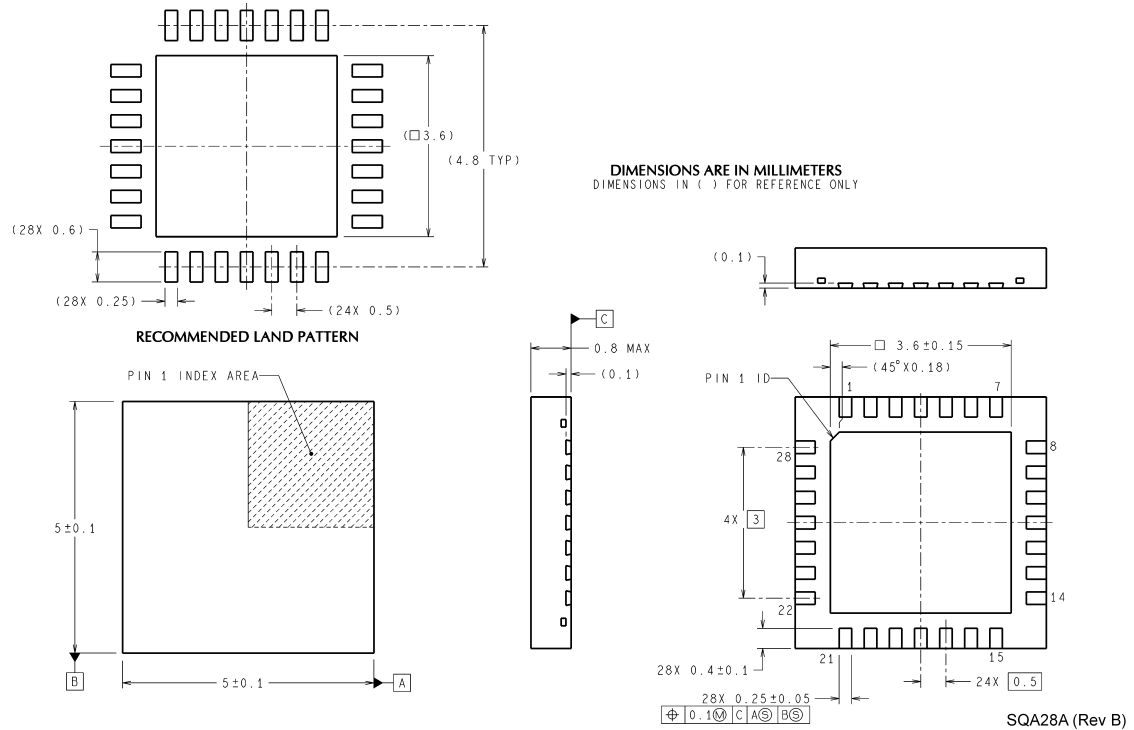

**LLP, Plastic, Quad**  
**Order Number LM4960SQ**  
**NS Package Number SQA28A**

National does not assume any responsibility for use of any circuitry described, no circuit patent licenses are implied and National reserves the right at any time without notice to change said circuitry and specifications.

For the most current product information visit us at [www.national.com](http://www.national.com).

**LIFE SUPPORT POLICY**

NATIONAL'S PRODUCTS ARE NOT AUTHORIZED FOR USE AS CRITICAL COMPONENTS IN LIFE SUPPORT DEVICES OR SYSTEMS WITHOUT THE EXPRESS WRITTEN APPROVAL OF THE PRESIDENT AND GENERAL COUNSEL OF NATIONAL SEMICONDUCTOR CORPORATION. As used herein:

1. Life support devices or systems are devices or systems which, (a) are intended for surgical implant into the body, or (b) support or sustain life, and whose failure to perform when properly used in accordance with instructions for use provided in the labeling, can be reasonably expected to result in a significant injury to the user.
2. A critical component is any component of a life support device or system whose failure to perform can be reasonably expected to cause the failure of the life support device or system, or to affect its safety or effectiveness.

**BANNED SUBSTANCE COMPLIANCE**

National Semiconductor manufactures products and uses packing materials that meet the provisions of the Customer Products Stewardship Specification (CSP-9-111C2) and the Banned Substances and Materials of Interest Specification (CSP-9-111S2) and contain no "Banned Substances" as defined in CSP-9-111S2.

 **National Semiconductor**  
**Americas Customer Support Center**  
 Email: [new.feedback@nsc.com](mailto:new.feedback@nsc.com)  
 Tel: 1-800-272-9959

**National Semiconductor**  
**Europe Customer Support Center**  
 Fax: +49 (0) 180-530 85 86  
 Email: [europe.support@nsc.com](mailto:europe.support@nsc.com)  
 Deutsch Tel: +49 (0) 69 9508 6208  
 English Tel: +44 (0) 870 24 0 2171  
 Français Tel: +33 (0) 1 41 91 8790

**National Semiconductor**  
**Asia Pacific Customer Support Center**  
 Email: [ap.support@nsc.com](mailto:ap.support@nsc.com)

**National Semiconductor**  
**Japan Customer Support Center**  
 Fax: 81-3-5639-7507  
 Email: [jpn.feedback@nsc.com](mailto:jpn.feedback@nsc.com)  
 Tel: 81-3-5639-7560

[www.national.com](http://www.national.com)

## IMPORTANT NOTICE

Texas Instruments Incorporated and its subsidiaries (TI) reserve the right to make corrections, modifications, enhancements, improvements, and other changes to its products and services at any time and to discontinue any product or service without notice. Customers should obtain the latest relevant information before placing orders and should verify that such information is current and complete. All products are sold subject to TI's terms and conditions of sale supplied at the time of order acknowledgment.

TI warrants performance of its hardware products to the specifications applicable at the time of sale in accordance with TI's standard warranty. Testing and other quality control techniques are used to the extent TI deems necessary to support this warranty. Except where mandated by government requirements, testing of all parameters of each product is not necessarily performed.

TI assumes no liability for applications assistance or customer product design. Customers are responsible for their products and applications using TI components. To minimize the risks associated with customer products and applications, customers should provide adequate design and operating safeguards.

TI does not warrant or represent that any license, either express or implied, is granted under any TI patent right, copyright, mask work right, or other TI intellectual property right relating to any combination, machine, or process in which TI products or services are used. Information published by TI regarding third-party products or services does not constitute a license from TI to use such products or services or a warranty or endorsement thereof. Use of such information may require a license from a third party under the patents or other intellectual property of the third party, or a license from TI under the patents or other intellectual property of TI.

Reproduction of TI information in TI data books or data sheets is permissible only if reproduction is without alteration and is accompanied by all associated warranties, conditions, limitations, and notices. Reproduction of this information with alteration is an unfair and deceptive business practice. TI is not responsible or liable for such altered documentation. Information of third parties may be subject to additional restrictions.

Resale of TI products or services with statements different from or beyond the parameters stated by TI for that product or service voids all express and any implied warranties for the associated TI product or service and is an unfair and deceptive business practice. TI is not responsible or liable for any such statements.

TI products are not authorized for use in safety-critical applications (such as life support) where a failure of the TI product would reasonably be expected to cause severe personal injury or death, unless officers of the parties have executed an agreement specifically governing such use. Buyers represent that they have all necessary expertise in the safety and regulatory ramifications of their applications, and acknowledge and agree that they are solely responsible for all legal, regulatory and safety-related requirements concerning their products and any use of TI products in such safety-critical applications, notwithstanding any applications-related information or support that may be provided by TI. Further, Buyers must fully indemnify TI and its representatives against any damages arising out of the use of TI products in such safety-critical applications.

TI products are neither designed nor intended for use in military/aerospace applications or environments unless the TI products are specifically designated by TI as military-grade or "enhanced plastic." Only products designated by TI as military-grade meet military specifications. Buyers acknowledge and agree that any such use of TI products which TI has not designated as military-grade is solely at the Buyer's risk, and that they are solely responsible for compliance with all legal and regulatory requirements in connection with such use.

TI products are neither designed nor intended for use in automotive applications or environments unless the specific TI products are designated by TI as compliant with ISO/TS 16949 requirements. Buyers acknowledge and agree that, if they use any non-designated products in automotive applications, TI will not be responsible for any failure to meet such requirements.

Following are URLs where you can obtain information on other Texas Instruments products and application solutions:

### Products

Audio	<a href="http://www.ti.com/audio">www.ti.com/audio</a>
Amplifiers	<a href="http://amplifier.ti.com">amplifier.ti.com</a>
Data Converters	<a href="http://dataconverter.ti.com">dataconverter.ti.com</a>
DLP® Products	<a href="http://www.dlp.com">www.dlp.com</a>
DSP	<a href="http://dsp.ti.com">dsp.ti.com</a>
Clocks and Timers	<a href="http://www.ti.com/clocks">www.ti.com/clocks</a>
Interface	<a href="http://interface.ti.com">interface.ti.com</a>
Logic	<a href="http://logic.ti.com">logic.ti.com</a>
Power Mgmt	<a href="http://power.ti.com">power.ti.com</a>
Microcontrollers	<a href="http://microcontroller.ti.com">microcontroller.ti.com</a>
RFID	<a href="http://www.ti-rfid.com">www.ti-rfid.com</a>
OMAP Mobile Processors	<a href="http://www.ti.com/omap">www.ti.com/omap</a>
Wireless Connectivity	<a href="http://www.ti.com/wirelessconnectivity">www.ti.com/wirelessconnectivity</a>

### Applications

Communications and Telecom	<a href="http://www.ti.com/communications">www.ti.com/communications</a>
Computers and Peripherals	<a href="http://www.ti.com/computers">www.ti.com/computers</a>
Consumer Electronics	<a href="http://www.ti.com/consumer-apps">www.ti.com/consumer-apps</a>
Energy and Lighting	<a href="http://www.ti.com/energy">www.ti.com/energy</a>
Industrial	<a href="http://www.ti.com/industrial">www.ti.com/industrial</a>
Medical	<a href="http://www.ti.com/medical">www.ti.com/medical</a>
Security	<a href="http://www.ti.com/security">www.ti.com/security</a>
Space, Avionics and Defense	<a href="http://www.ti.com/space-avionics-defense">www.ti.com/space-avionics-defense</a>
Transportation and Automotive	<a href="http://www.ti.com/automotive">www.ti.com/automotive</a>
Video and Imaging	<a href="http://www.ti.com/video">www.ti.com/video</a>

TI E2E Community Home Page

[e2e.ti.com](http://e2e.ti.com)

Mailing Address: Texas Instruments, Post Office Box 655303, Dallas, Texas 75265  
Copyright © 2011, Texas Instruments Incorporated

[www.BDTIC.com/TI](http://www.BDTIC.com/TI)