

## NANOPOWER 1.8-V SOT23 COMPARATORS WITH VOLTAGE REFERENCE

### FEATURES

- **Controlled Baseline**
  - One Assembly/Test Site
  - One Fabrication Site
- **Extended Temperature Performance of –55°C to 125°C**
- **Enhanced Diminishing Manufacturing Sources (DMS) Support**
- **Enhanced Product-Change Notification**
- **Qualification Pedigree<sup>(1)</sup>**
- **Low Quiescent Current = 5  $\mu$ A (Max)**
- **Integrated Voltage Reference = 1.242 V**
- **Input Common-Mode Range = 200 mV Beyond Rails**
- **Voltage Reference Initial Accuracy = 1%**
- **Open-Drain Logic Compatible Output (TLV3011)**
- **Push-Pull Output (TLV3012)**
- **Low Supply Voltage = 1.8 V to 5.5 V**
- **Fast Response Time = 6- $\mu$ s Propagation Delay With 100-mV Overdrive (TLV3011: R<sub>PULLUP</sub> = 10 k $\Omega$ )**
- **Microsize Package: SOT23-6**

(1) Component qualification in accordance with JEDEC and industry standards to ensure reliable operation over an extended temperature range. This includes, but is not limited to, Highly Accelerated Stress Test (HAST) or biased 85/85, temperature cycle, autoclave or unbiased HAST, electromigration, bond intermetallic life, and mold compound life. Such qualification testing should not be viewed as justifying use of this component beyond specified performance and environmental limits.

### APPLICATIONS

- **Battery-Powered Level Detection**
- **Data Acquisition**
- **System Monitoring**
- **Oscillators**
- **Sensor Systems**
  - Smoke Detectors
  - Light Sensors
  - Alarms

### DESCRIPTION

The TLV3011 and TLV3012 are low-power, open-drain output comparators. The devices feature an uncommitted on-chip voltage reference, have 5- $\mu$ A (max) quiescent current, input common-mode range 200 mV beyond the supply rails, and single-supply operation from 1.8 V to 5.5 V. The integrated 1.242-V series voltage reference offers low 100-ppm/ $^{\circ}$ C (max) drift, is stable with up to 10-nF capacitive load, and can provide up to 0.5 mA (typ) of output current.

The TLV3011 and TLV3012 are available in the tiny SOT23-6 package for space-conservative designs. The devices are specified for the temperature range of –55°C to 125°C.

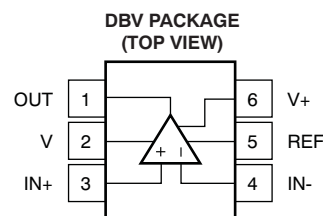

Please be aware that an important notice concerning availability, standard warranty, and use in critical applications of Texas Instruments semiconductor products and disclaimers thereto appears at the end of this data sheet.



This integrated circuit can be damaged by ESD. Texas Instruments recommends that all integrated circuits be handled with appropriate precautions. Failure to observe proper handling and installation procedures can cause damage.

ESD damage can range from subtle performance degradation to complete device failure. Precision integrated circuits may be more susceptible to damage because very small parametric changes could cause the device not to meet its published specifications.

### PACKAGE ORDERING INFORMATION

T <sub>A</sub>	PACKAGE <sup>(1)</sup>	ORDERABLE PART NUMBER	TOP SIDE MARKING
-55°C TO 125°C	DBV-SOT	TLV3011AMDBVREP	BTV
	DBV-SOT	TLV3012AMDBVREP <sup>(2)</sup>	TBD

(1) Package drawings, standard packing quantities, thermal data, symbolization, and PCB design guidelines are available at [www.ti.com/sc/package](http://www.ti.com/sc/package).

(2) Product Preview

### Pin Configurations

#### Top View

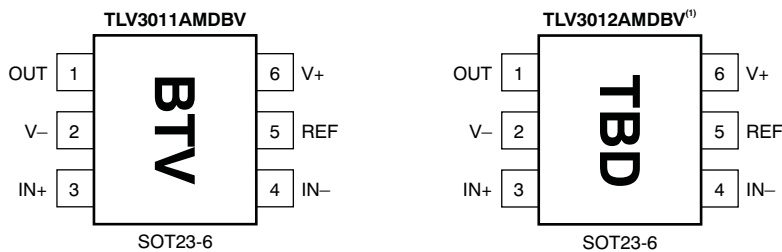

Note: Pin 1 is determined by orienting package marking as shown.

<sup>(1)</sup> Product Preview

### ABSOLUTE MAXIMUM RATINGS<sup>(1)</sup>

over operating free-air temperature range (unless otherwise noted)

	MIN	MAX	UNIT
Supply voltage		7	V
Signal input terminals	Voltage <sup>(2)</sup>	-0.5 (V+) +0.5	V
	Current <sup>(2)</sup>	±10	mA
Output short circuit <sup>(3)</sup>		Continuous	
Operating temperature range	-55	125	°C
T <sub>stg</sub> Storage temperature range	-65	150	°C
T <sub>J</sub> Junction temperature		150	°C
Lead ambient temperature (soldering, 10 s)		300	°C
ESD rating (Human-Body Model)		2000	V

(1) Stresses beyond those listed under "absolute maximum ratings" may cause permanent damage to the device. These are stress ratings only, and functional operation of the device at these or any other conditions beyond those indicated under "recommended operating conditions" is not implied. Exposure to absolute-maximum-rated conditions for extended periods may affect device reliability.

(2) All voltage values are with respect to the network ground terminal.

(3) Short circuit to ground

## ELECTRICAL CHARACTERISTICS

over operating free-air temperature range (unless otherwise noted)

PARAMETER		TEST CONDITIONS	MIN	TYP	MAX	UNIT
<b>Offset Voltage</b>						
$V_{OS}$	Input offset voltage	$V_{CM} = 0\text{ V}$ , $I_O = 0\text{ V}$		0.5	15	mV
$dV_{OS}/dT$	Input offset voltage vs temperature	$T_A = -55^\circ\text{C}$ to $125^\circ\text{C}$		$\pm 12$		$\mu\text{V}/^\circ\text{C}$
PSRR	Power supply rejection ratio	$V_S = 1.8\text{ V}$ to $5.5\text{ V}$		100	1000	$\mu\text{V}/\text{V}$
<b>Input Bias Current</b>						
$I_S$	Input bias current	$V_{CM} = V_S/2$		$\pm 10$		pA
$I_{OS}$	Input offset current	$V_{CM} = V_S/2$		$\pm 10$		pA
<b>Input Voltage Range</b>						
$V_{CM}$	Common-mode voltage range		$(V_-) - 0.2$		$(V_+) + 0.2$	V
CMRR	Common-mode rejection ratio	$V_{CM} = -0.2\text{ V}$ to $(V_+) - 1.5\text{ V}$	60	74		dB
		$V_{CM} = -0.2\text{ V}$ to $(V_+) + 0.2\text{ V}$	54	62		
<b>Input Impedance</b>						
	Common mode			$10^{13} \parallel 2$		$\Omega \parallel \text{pF}$
	Differential			$10^{13} \parallel 4$		$\Omega \parallel \text{pF}$
<b>Switching Characteristics</b>						
Propagation delay time	Low to high	$f = 10\text{ kHz}$ , $V_{STEP} = 1\text{ V}$ , input overdrive = $10\text{ mV}$		12		$\mu\text{s}$
		$f = 10\text{ kHz}$ , $V_{STEP} = 1\text{ V}$ , input overdrive = $100\text{ mV}$		6		
	High to low	$f = 10\text{ kHz}$ , $V_{STEP} = 1\text{ V}$ , input overdrive = $10\text{ mV}$		13.5		
		$f = 10\text{ kHz}$ , $V_{STEP} = 1\text{ V}$ , input overdrive = $100\text{ mV}$		6.5		
$t_r$	Rise time	TLV3011		See <sup>(1)</sup>		
		TLV3012 <sup>(2)</sup>	$C_L = 10\text{ pF}$	100		ns
$t_f$	Fall time		$C_L = 10\text{ pF}$	100		ns
<b>Output</b>						
$V_{OL}$	Voltage output low from rail	$V_S = 5\text{ V}$		160	200	mV
	Voltage output high from rail	TLV3012 <sup>(2)</sup>	$I_{OUT} = -5\text{ mA}$	90	200	mV
	Short-circuit current	TLV3012 <sup>(2)</sup>	$I_{OUT} = 5\text{ mA}$	See Typical Characteristics		
<b>Voltage Reference</b>						
$V_{OUT}$	Output voltage		1.208	1.242	1.276	V
	Initial accuracy				$\pm 1\%$	
$dV_{OUT}/dT$	Temperature drift	$-55^\circ\text{C} \leq T_A \leq 125^\circ\text{C}$		40	100	ppm/ $^\circ\text{C}$
$dV_{OUT}/dI_{LOAD}$	Load regulation	Sourcing	$0\text{ mA} < I_{SOURCE} \leq 0.5\text{ mA}$	0.36	1	mV/mA
		Sinking	$0\text{ mA} < I_{SINK} \leq 0.5\text{ mA}$	6.6		
$I_{LOAD}$	Output current			0.5		mA
$dV_{OUT}/dV_{IN}$	Line regulation	$1.8\text{ V} \leq V_{IN} \leq 5.5\text{ V}$		10	100	$\mu\text{V}/\text{V}$
<b>Noise</b>						
	Reference voltage noise	$f = 0.1\text{ Hz}$ to $10\text{ Hz}$		0.2		mV <sub>PP</sub>
<b>Power Supply</b>						
$V_S$	Specified voltage		1.8		5.5	V
	Operating voltage range		1.8		5.5	V
$I_Q$	Quiescent current	$V_S = 5\text{ V}$ , $V_O = \text{High}$		2.8	5	$\mu\text{A}$

(1)  $t_r$  dependent on  $R_{PULLUP}$  and  $C_{LOAD}$ .

(2) Product Preview

**ELECTRICAL CHARACTERISTICS (continued)**

over operating free-air temperature range (unless otherwise noted)

PARAMETER		TEST CONDITIONS	MIN	TYP	MAX	UNIT
<b>Temperature</b>						
Operating range			-55		125	°C
Storage range			-65		150	°C
Thermal resistance	SOT23-6			200		°C/W

**TYPICAL CHARACTERISTICS**

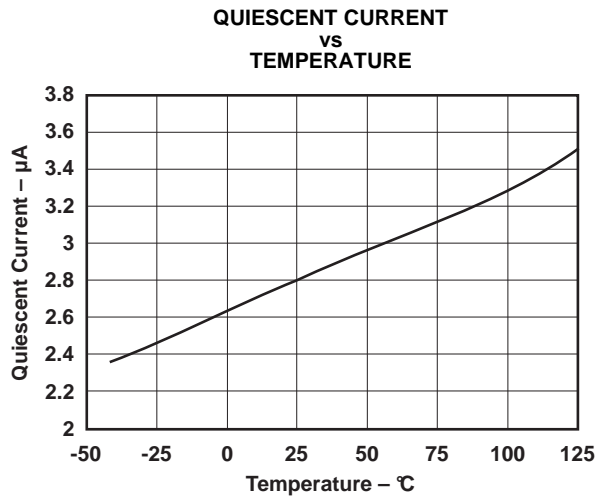

Figure 1.

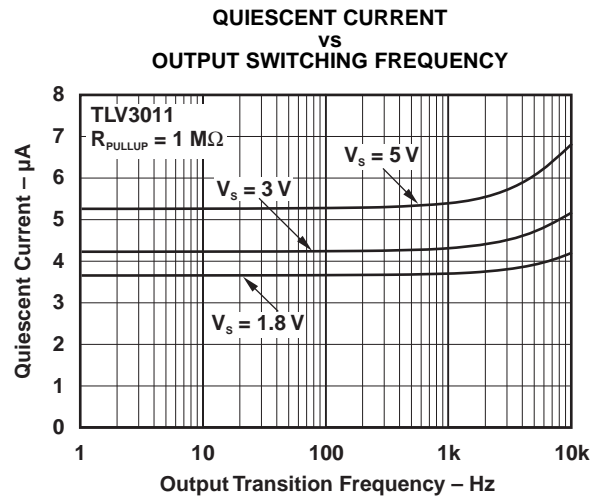

Figure 2.

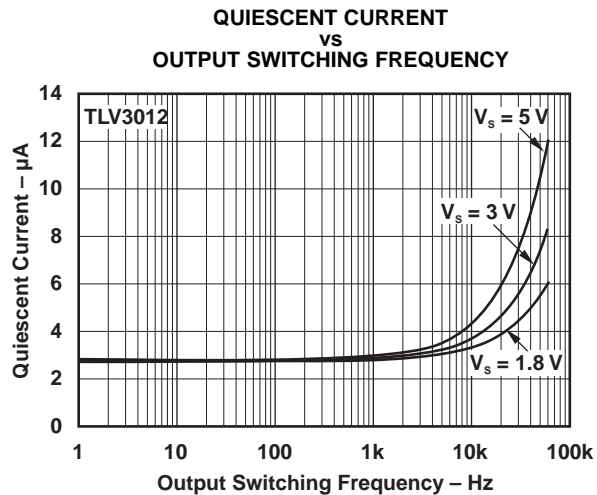

Figure 3.

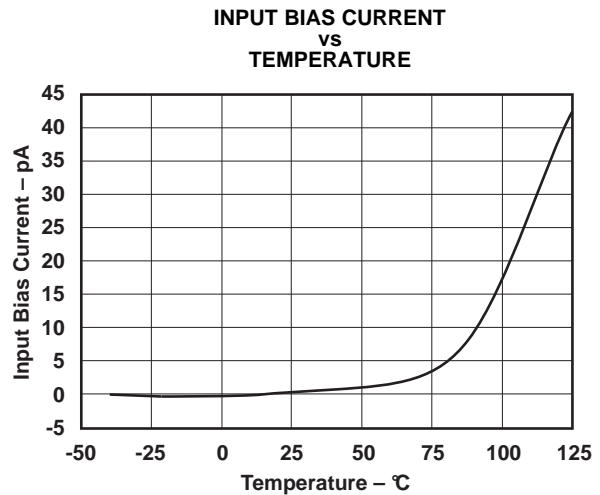

Figure 4.

TYPICAL CHARACTERISTICS (continued)

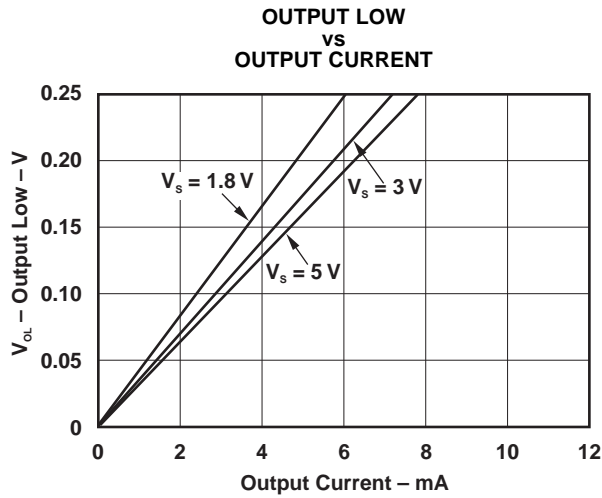

Figure 5.

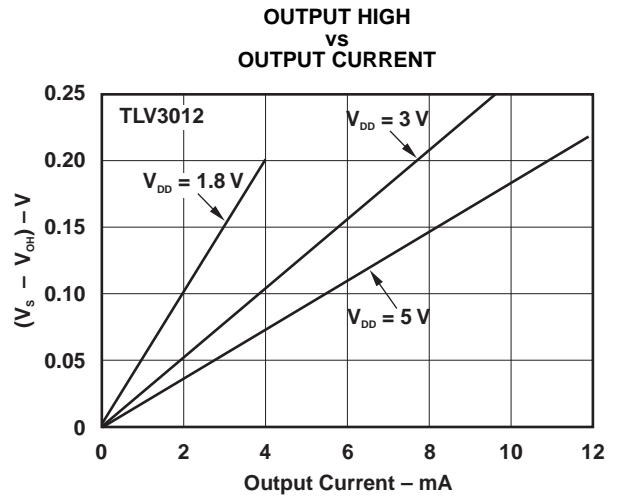

Figure 6.

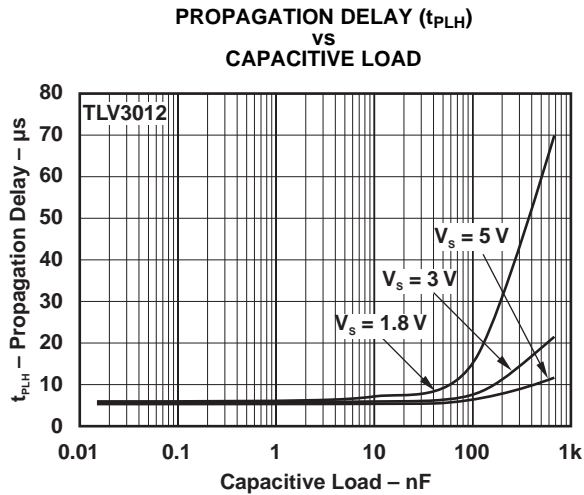

Figure 7.

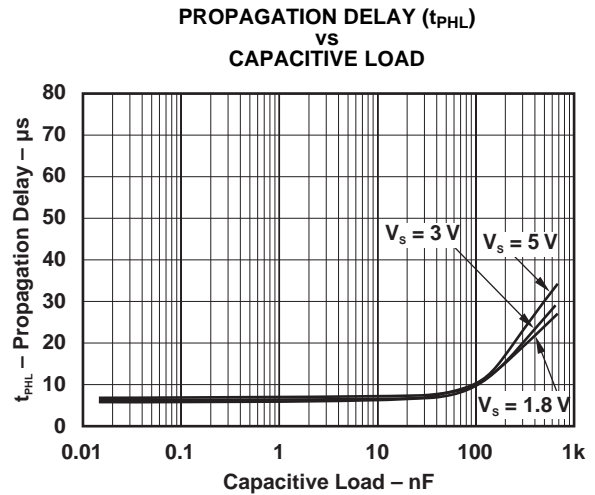

Figure 8.

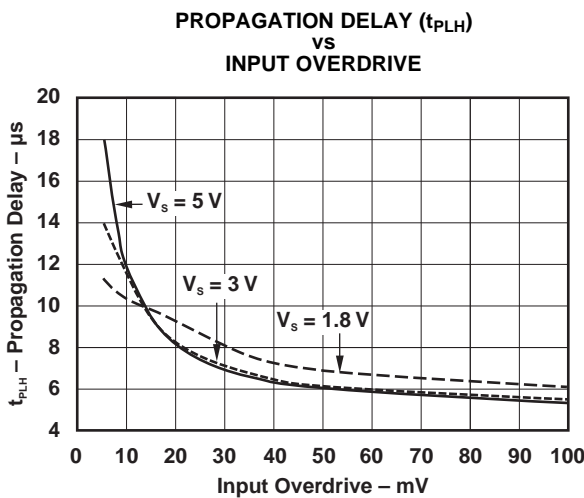

Figure 9.

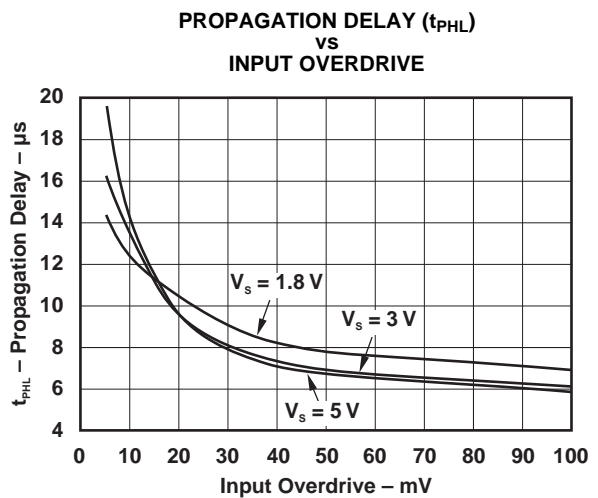

Figure 10.

TYPICAL CHARACTERISTICS (continued)

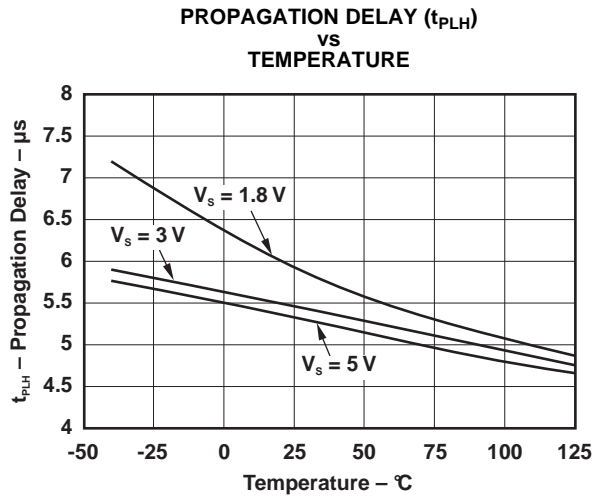

Figure 11.

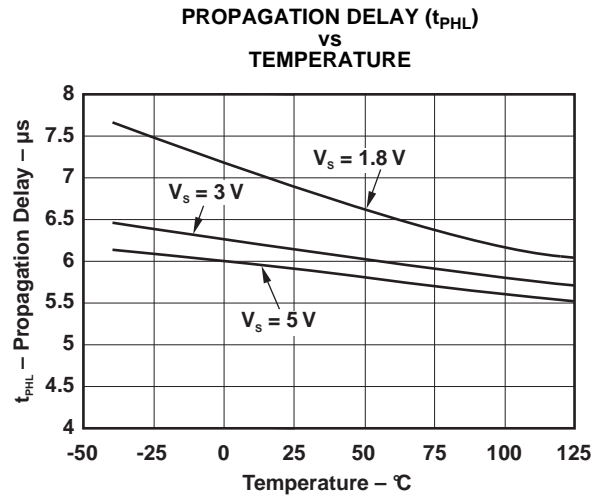

Figure 12.

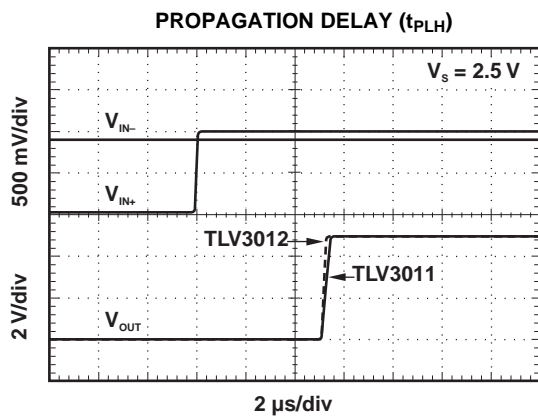

Figure 13.

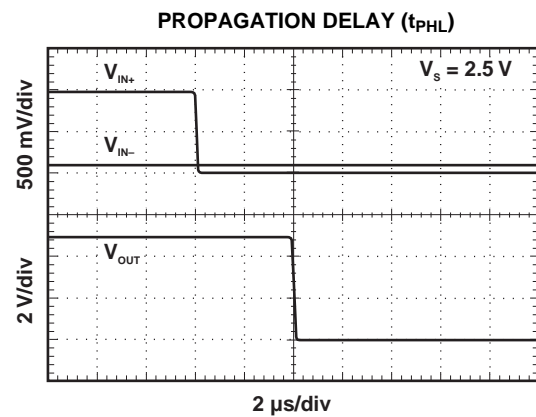

Figure 14.

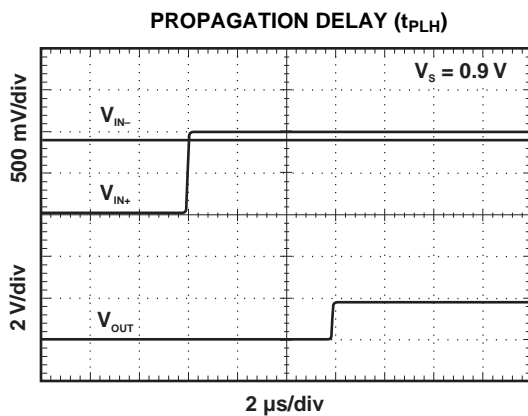

Figure 15.

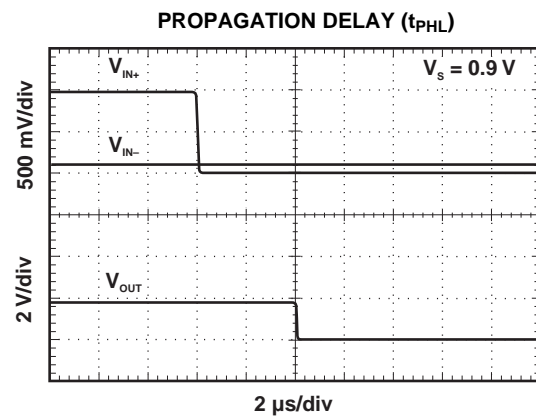

Figure 16.

TYPICAL CHARACTERISTICS (continued)

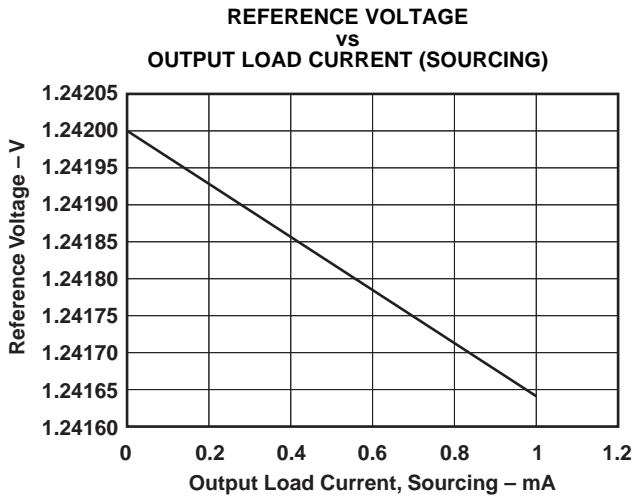

Figure 17.

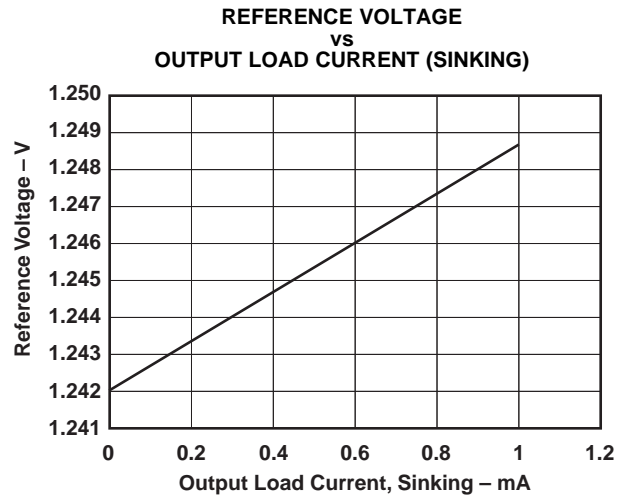

Figure 18.

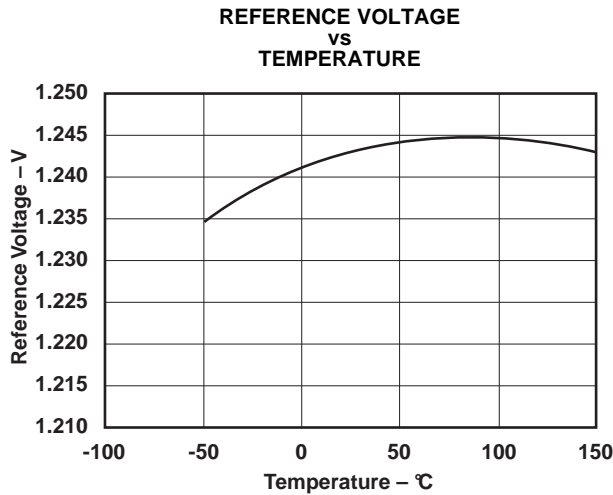

Figure 19.

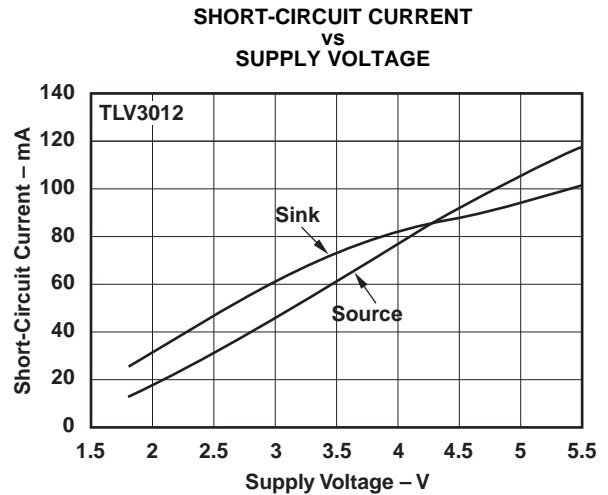

Figure 20.

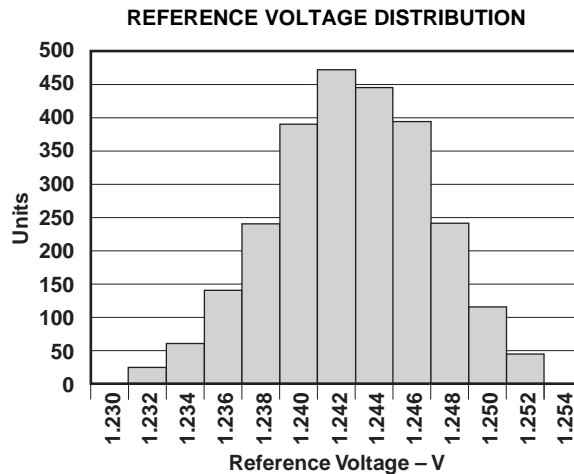

Figure 21.

## APPLICATION INFORMATION

The TLV3011 is a low-power, open-drain comparator with on-chip 1.242-V series reference. The open-drain output allows multiple devices to be driven by a single pullup resistor to accomplish an OR function, making the TLV3011 useful for logic applications.

The TLV3012 comparator with on-chip 1.242-V series reference has a push-pull output stage optimal for reduced power budget applications and features no shoot-through current.

A typical supply current of 2.8  $\mu\text{A}$  and small packaging combine with 1.8-V supply requirements to make the TLV3011 and TLV3012 optimal for battery and portable designs.

### Board Layout

Typical connections for the TLV3011 and TLV3012 are shown in Figure 22. The TLV3011 is an open-drain output device. A pullup resistor must be connected between the comparator output and supply to enable operation.

To minimize supply noise, power supplies should be capacitively decoupled by a 0.01- $\mu\text{F}$  ceramic capacitor in parallel with a 1- $\mu\text{F}$  electrolytic capacitor. Comparators are sensitive to input noise and precautions such as proper grounding (use of ground plane), supply bypassing, and guarding of high-impedance nodes minimize the effects of noise and help to ensure specified performance.

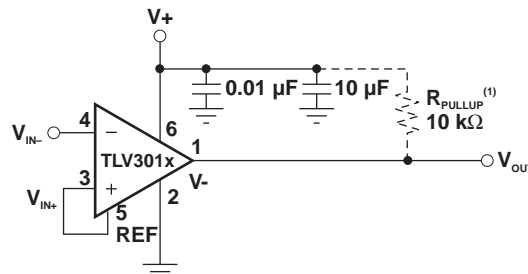

(1) Use  $R_{\text{PULLUP}}$  with the TLV3011 only.

Figure 22. Basic Connections of the TLV3011 and TLV3012

### Open-Drain Output (TLV3011)

The open-drain output of the TLV3011 is useful in logic applications. The value of the pullup resistor and supply voltage used affects current consumption due to additional current drawn when the output is in a low state. This effect can be seen in Figure 3.

### External Hysteresis

Comparator inputs have no noise immunity within the range of specified offset voltage ( $\pm 12$  mV). For noisy input signals, the comparator output may display multiple switching as input signals move through the switching threshold. The typical comparator threshold of the TLV3011 and TLV3012 is  $\pm 0.5$  mV. To prevent multiple switching within the comparator threshold of the TLV3011 or TLV3012, external hysteresis may be added by connecting a small amount of feedback to the positive input. Figure 23 shows a typical topology used to introduce hysteresis, described by this equation:

$$V_{\text{HYST}} = \frac{V_+ \times R_1}{R_1 + R_2}$$



APPLICATION INFORMATION (continued)

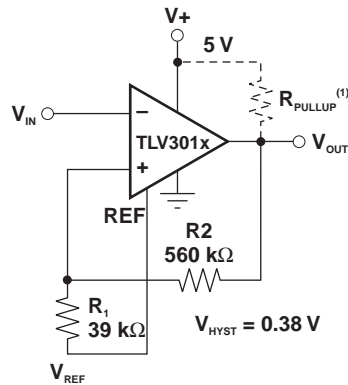

(1) Use  $R_{PULLUP}$  with the TLV3011 only.

Figure 23. Adding Hysteresis

$V_{HYST}$  sets the value of the transition voltage required to switch the comparator output by increasing the threshold region, thereby reducing sensitivity to noise.

Applications

Battery-Level Detect

The low power consumption and 1.8-V supply voltage of the TLV3011 make it an excellent candidate for battery-powered applications. Figure 24 shows the TLV3011 configured as a low battery level detector for a 3-V battery.

$$\text{Battery Okay trip voltage} = 1.242 \frac{R_1 + R_2}{R_2}$$

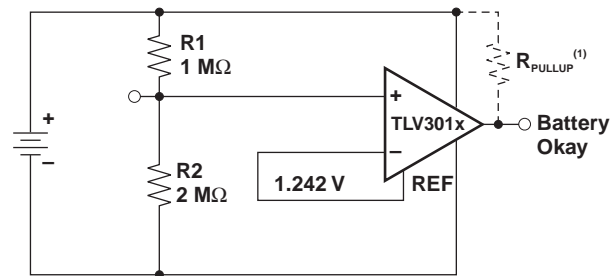

When the battery voltage drops below 1.9 V, the Battery Okay output goes low.

(1) Use  $R_{PULLUP}$  with the TLV3011 only.

Figure 24. TLV3011 Configured as Low Battery Level Detector

APPLICATION INFORMATION (continued)

Power-On Reset

The reset circuit shown in Figure 25 provides a time-delayed release of reset to the MSP430 microcontroller. Operation of the circuit is based on a stabilization time constant of the supply voltage, rather than on a predetermined voltage value. The negative input is a reference voltage created by the internal voltage reference. The positive input is an RC circuit that provides a power-up delay. When power is applied, the output of the comparator is low, holding the processor in the reset condition. Only after allowing time for the supply voltage to stabilize does the positive input of the comparator become higher than the negative input, resulting in a high output state, releasing the processor for operation. The stabilization time required for the supply voltage is adjustable by the selection of the RC component values. Use of a lower-valued resistor in this portion of the circuit does not increase current consumption, because no current flows through the RC circuit after the supply has stabilized.

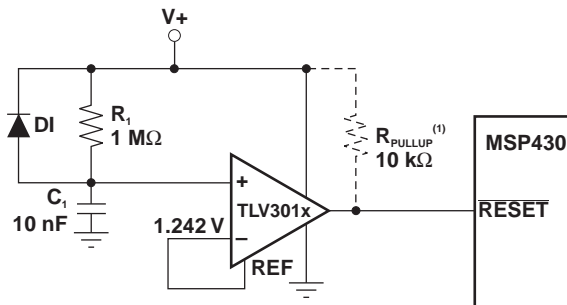

(1) Use  $R_{PULLUP}$  with the TLV3011 only.

Figure 25. TLV3011 or TLV3012 Configured as Power-Up Reset Circuit for the MSP430

The reset delay needed depends on the power-up characteristics of the system power supply.  $R_1$  and  $C_1$  are selected to allow enough time for the power supply to stabilize.  $D_1$  provides rapid reset if power is lost. In this example, the  $R_1 \times C_1$  time constant is 10 ms.

Relaxation Oscillator

The TLV3012 can be configured as a relaxation oscillator to provide a simple and inexpensive clock output (see Figure 26). The capacitor is charged at a rate of  $T = 0.69RC$  and discharges at a rate of  $0.69RC$ . Therefore, the period is  $T = 1.38RC$ .  $R_1$  may be a different value than  $R_2$ .

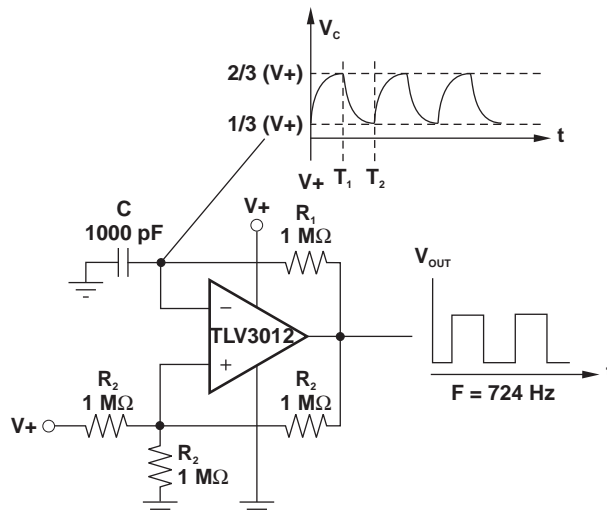

Figure 26. TLV3012 Configured as Relaxation Oscillator

**PACKAGING INFORMATION**

Orderable Device	Status <sup>(1)</sup>	Package Type	Package Drawing	Pins	Package Qty	Eco Plan <sup>(2)</sup>	Lead/ Ball Finish	MSL Peak Temp <sup>(3)</sup>	Samples (Requires Login)
TLV3011AMDBVREP	ACTIVE	SOT-23	DBV	6	3000	Green (RoHS & no Sb/Br)	CU NIPDAU	Level-1-260C-UNLIM	<a href="#">Add to cart</a>
V62/07604-01XE	ACTIVE	SOT-23	DBV	6	3000	Green (RoHS & no Sb/Br)	CU NIPDAU	Level-1-260C-UNLIM	<a href="#">Add to cart</a>

<sup>(1)</sup> The marketing status values are defined as follows:

**ACTIVE:** Product device recommended for new designs.

**LIFEBUY:** TI has announced that the device will be discontinued, and a lifetime-buy period is in effect.

**NRND:** Not recommended for new designs. Device is in production to support existing customers, but TI does not recommend using this part in a new design.

**PREVIEW:** Device has been announced but is not in production. Samples may or may not be available.

**OBsolete:** TI has discontinued the production of the device.

<sup>(2)</sup> Eco Plan - The planned eco-friendly classification: Pb-Free (RoHS), Pb-Free (RoHS Exempt), or Green (RoHS & no Sb/Br) - please check <http://www.ti.com/productcontent> for the latest availability information and additional product content details.

**TBD:** The Pb-Free/Green conversion plan has not been defined.

**Pb-Free (RoHS):** TI's terms "Lead-Free" or "Pb-Free" mean semiconductor products that are compatible with the current RoHS requirements for all 6 substances, including the requirement that lead not exceed 0.1% by weight in homogeneous materials. Where designed to be soldered at high temperatures, TI Pb-Free products are suitable for use in specified lead-free processes.

**Pb-Free (RoHS Exempt):** This component has a RoHS exemption for either 1) lead-based flip-chip solder bumps used between the die and package, or 2) lead-based die adhesive used between the die and leadframe. The component is otherwise considered Pb-Free (RoHS compatible) as defined above.

**Green (RoHS & no Sb/Br):** TI defines "Green" to mean Pb-Free (RoHS compatible), and free of Bromine (Br) and Antimony (Sb) based flame retardants (Br or Sb do not exceed 0.1% by weight in homogeneous material)

<sup>(3)</sup> MSL, Peak Temp. -- The Moisture Sensitivity Level rating according to the JEDEC industry standard classifications, and peak solder temperature.

**Important Information and Disclaimer:** The information provided on this page represents TI's knowledge and belief as of the date that it is provided. TI bases its knowledge and belief on information provided by third parties, and makes no representation or warranty as to the accuracy of such information. Efforts are underway to better integrate information from third parties. TI has taken and continues to take reasonable steps to provide representative and accurate information but may not have conducted destructive testing or chemical analysis on incoming materials and chemicals. TI and TI suppliers consider certain information to be proprietary, and thus CAS numbers and other limited information may not be available for release.

In no event shall TI's liability arising out of such information exceed the total purchase price of the TI part(s) at issue in this document sold by TI to Customer on an annual basis.

**OTHER QUALIFIED VERSIONS OF TLV3011-EP :**

- Catalog: [TLV3011](#)

NOTE: Qualified Version Definitions:

- Catalog - TI's standard catalog product

**TAPE AND REEL INFORMATION**

**QUADRANT ASSIGNMENTS FOR PIN 1 ORIENTATION IN TAPE**

\*All dimensions are nominal

Device	Package Type	Package Drawing	Pins	SPQ	Reel Diameter (mm)	Reel Width W1 (mm)	A0 (mm)	B0 (mm)	K0 (mm)	P1 (mm)	W (mm)	Pin1 Quadrant
TLV3011AMDBVREP	SOT-23	DBV	6	3000	179.0	8.4	3.2	3.2	1.4	4.0	8.0	Q3

TAPE AND REEL BOX DIMENSIONS



\*All dimensions are nominal

Device	Package Type	Package Drawing	Pins	SPQ	Length (mm)	Width (mm)	Height (mm)
TLV3011AMDBVREP	SOT-23	DBV	6	3000	203.0	203.0	35.0

DBV (R-PDSO-G6)

PLASTIC SMALL-OUTLINE PACKAGE

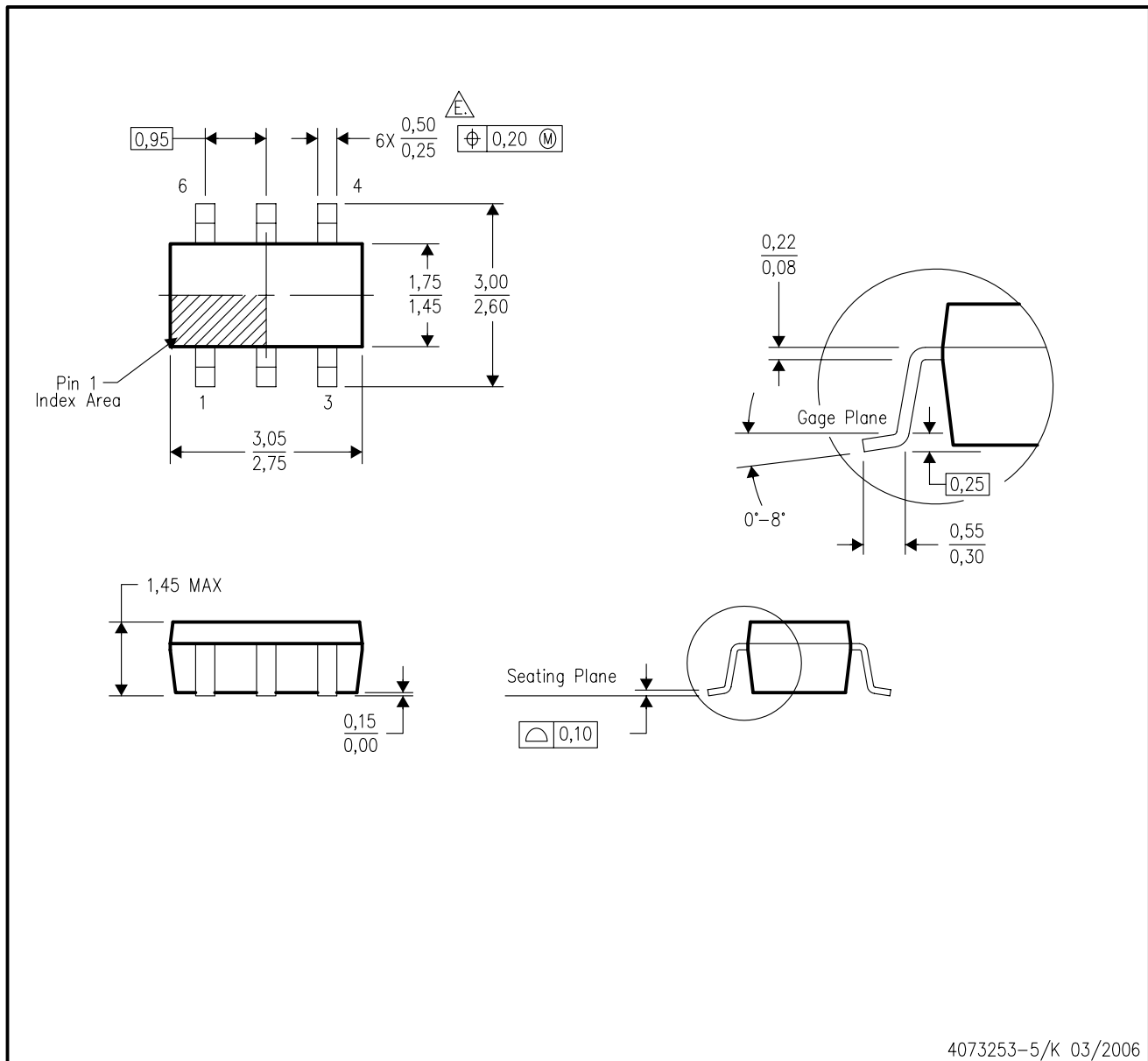

- NOTES:
- All linear dimensions are in millimeters.
  - This drawing is subject to change without notice.
  - Body dimensions do not include mold flash or protrusion. Mold flash and protrusion shall not exceed 0.15 per side.
  - Leads 1,2,3 may be wider than leads 4,5,6 for package orientation.
- $\triangle$  Falls within JEDEC MO-178 Variation AB, except minimum lead width.

DBV (R-PDSO-G6)

PLASTIC SMALL OUTLINE

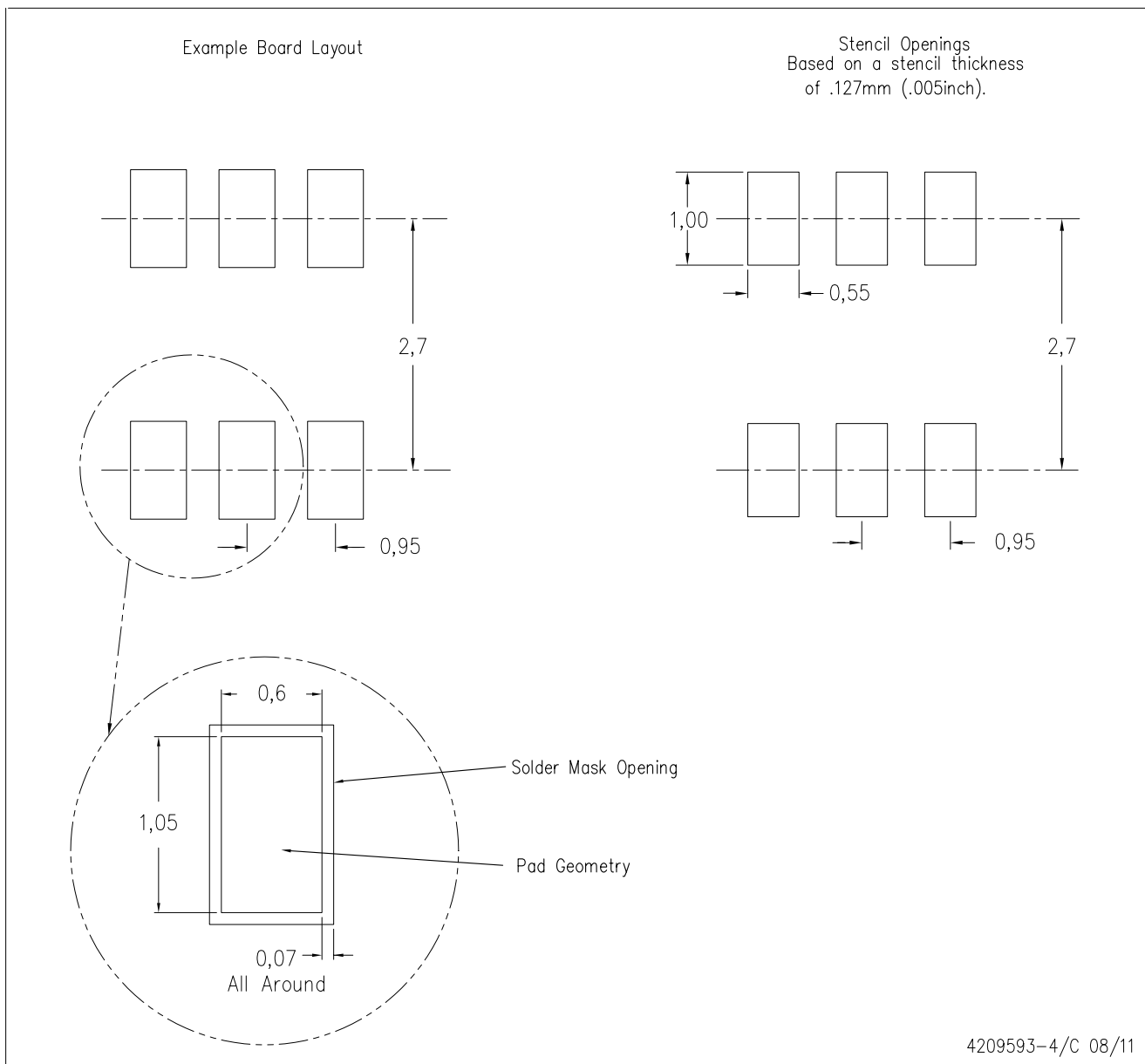

- NOTES:
- A. All linear dimensions are in millimeters.
  - B. This drawing is subject to change without notice.
  - C. Customers should place a note on the circuit board fabrication drawing not to alter the center solder mask defined pad.
  - D. Publication IPC-7351 is recommended for alternate designs.
  - E. Laser cutting apertures with trapezoidal walls and also rounding corners will offer better paste release. Customers should contact their board assembly site for stencil design recommendations. Example stencil design based on a 50% volumetric metal load solder paste. Refer to IPC-7525 for other stencil recommendations.



DCK (R-PDSO-G6)

PLASTIC SMALL-OUTLINE PACKAGE

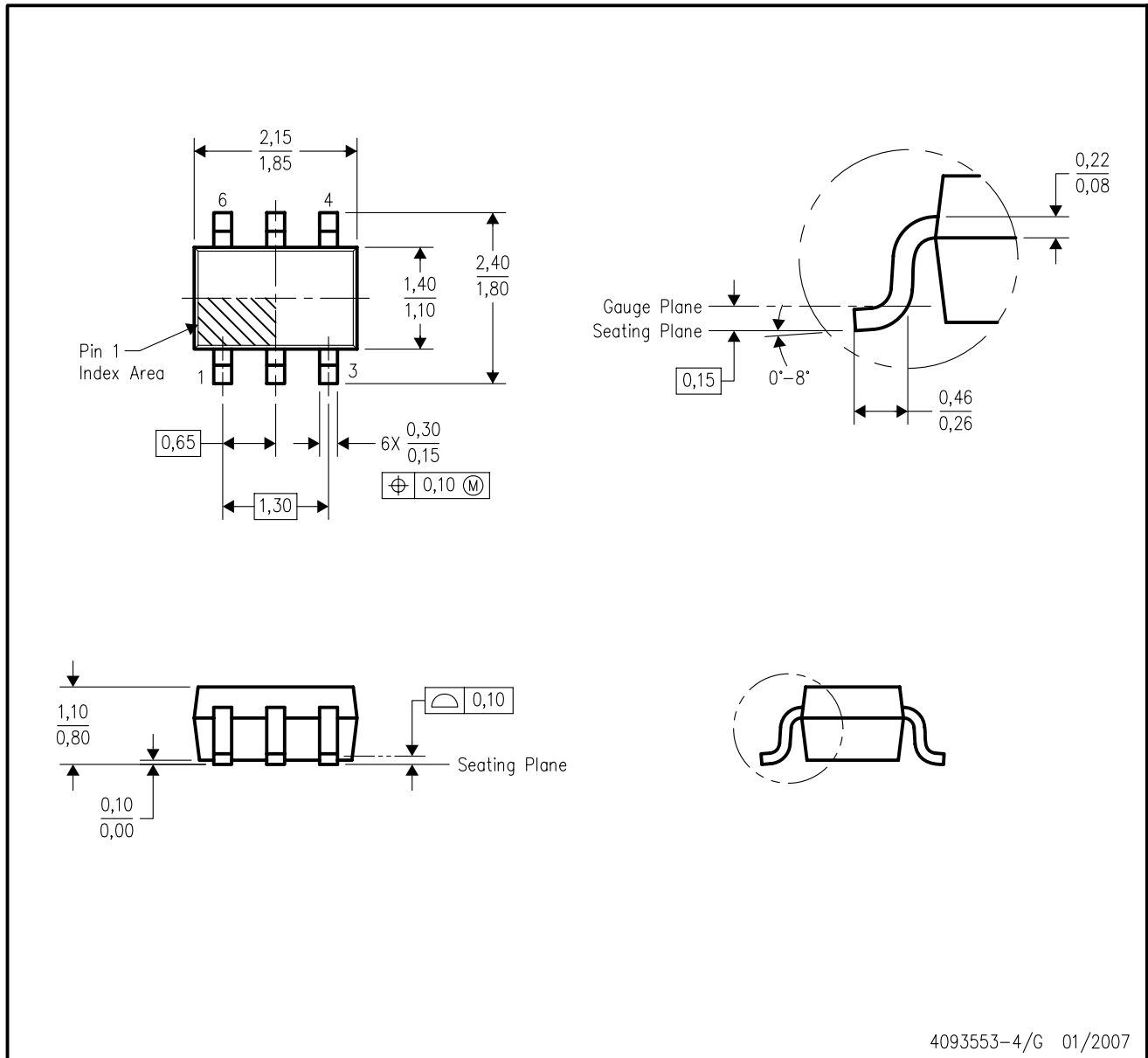

- NOTES:
- A. All linear dimensions are in millimeters.
  - B. This drawing is subject to change without notice.
  - C. Body dimensions do not include mold flash or protrusion. Mold flash and protrusion shall not exceed 0.15 per side.
  - D. Falls within JEDEC MO-203 variation AB.

## IMPORTANT NOTICE

Texas Instruments Incorporated and its subsidiaries (TI) reserve the right to make corrections, modifications, enhancements, improvements, and other changes to its products and services at any time and to discontinue any product or service without notice. Customers should obtain the latest relevant information before placing orders and should verify that such information is current and complete. All products are sold subject to TI's terms and conditions of sale supplied at the time of order acknowledgment.

TI warrants performance of its hardware products to the specifications applicable at the time of sale in accordance with TI's standard warranty. Testing and other quality control techniques are used to the extent TI deems necessary to support this warranty. Except where mandated by government requirements, testing of all parameters of each product is not necessarily performed.

TI assumes no liability for applications assistance or customer product design. Customers are responsible for their products and applications using TI components. To minimize the risks associated with customer products and applications, customers should provide adequate design and operating safeguards.

TI does not warrant or represent that any license, either express or implied, is granted under any TI patent right, copyright, mask work right, or other TI intellectual property right relating to any combination, machine, or process in which TI products or services are used. Information published by TI regarding third-party products or services does not constitute a license from TI to use such products or services or a warranty or endorsement thereof. Use of such information may require a license from a third party under the patents or other intellectual property of the third party, or a license from TI under the patents or other intellectual property of TI.

Reproduction of TI information in TI data books or data sheets is permissible only if reproduction is without alteration and is accompanied by all associated warranties, conditions, limitations, and notices. Reproduction of this information with alteration is an unfair and deceptive business practice. TI is not responsible or liable for such altered documentation. Information of third parties may be subject to additional restrictions.

Resale of TI products or services with statements different from or beyond the parameters stated by TI for that product or service voids all express and any implied warranties for the associated TI product or service and is an unfair and deceptive business practice. TI is not responsible or liable for any such statements.

TI products are not authorized for use in safety-critical applications (such as life support) where a failure of the TI product would reasonably be expected to cause severe personal injury or death, unless officers of the parties have executed an agreement specifically governing such use. Buyers represent that they have all necessary expertise in the safety and regulatory ramifications of their applications, and acknowledge and agree that they are solely responsible for all legal, regulatory and safety-related requirements concerning their products and any use of TI products in such safety-critical applications, notwithstanding any applications-related information or support that may be provided by TI. Further, Buyers must fully indemnify TI and its representatives against any damages arising out of the use of TI products in such safety-critical applications.

TI products are neither designed nor intended for use in military/aerospace applications or environments unless the TI products are specifically designated by TI as military-grade or "enhanced plastic." Only products designated by TI as military-grade meet military specifications. Buyers acknowledge and agree that any such use of TI products which TI has not designated as military-grade is solely at the Buyer's risk, and that they are solely responsible for compliance with all legal and regulatory requirements in connection with such use.

TI products are neither designed nor intended for use in automotive applications or environments unless the specific TI products are designated by TI as compliant with ISO/TS 16949 requirements. Buyers acknowledge and agree that, if they use any non-designated products in automotive applications, TI will not be responsible for any failure to meet such requirements.

Following are URLs where you can obtain information on other Texas Instruments products and application solutions:

### Products

Audio	<a href="http://www.ti.com/audio">www.ti.com/audio</a>
Amplifiers	<a href="http://amplifier.ti.com">amplifier.ti.com</a>
Data Converters	<a href="http://dataconverter.ti.com">dataconverter.ti.com</a>
DLP® Products	<a href="http://www.dlp.com">www.dlp.com</a>
DSP	<a href="http://dsp.ti.com">dsp.ti.com</a>
Clocks and Timers	<a href="http://www.ti.com/clocks">www.ti.com/clocks</a>
Interface	<a href="http://interface.ti.com">interface.ti.com</a>
Logic	<a href="http://logic.ti.com">logic.ti.com</a>
Power Mgmt	<a href="http://power.ti.com">power.ti.com</a>
Microcontrollers	<a href="http://microcontroller.ti.com">microcontroller.ti.com</a>
RFID	<a href="http://www.ti-rfid.com">www.ti-rfid.com</a>
RF/IF and ZigBee® Solutions	<a href="http://www.ti.com/lprf">www.ti.com/lprf</a>

### Applications

Communications and Telecom	<a href="http://www.ti.com/communications">www.ti.com/communications</a>
Computers and Peripherals	<a href="http://www.ti.com/computers">www.ti.com/computers</a>
Consumer Electronics	<a href="http://www.ti.com/consumer-apps">www.ti.com/consumer-apps</a>
Energy and Lighting	<a href="http://www.ti.com/energy">www.ti.com/energy</a>
Industrial	<a href="http://www.ti.com/industrial">www.ti.com/industrial</a>
Medical	<a href="http://www.ti.com/medical">www.ti.com/medical</a>
Security	<a href="http://www.ti.com/security">www.ti.com/security</a>
Space, Avionics and Defense	<a href="http://www.ti.com/space-avionics-defense">www.ti.com/space-avionics-defense</a>
Transportation and Automotive	<a href="http://www.ti.com/automotive">www.ti.com/automotive</a>
Video and Imaging	<a href="http://www.ti.com/video">www.ti.com/video</a>
Wireless	<a href="http://www.ti.com/wireless-apps">www.ti.com/wireless-apps</a>

TI E2E Community Home Page

[e2e.ti.com](http://e2e.ti.com)

Mailing Address: Texas Instruments, Post Office Box 655303, Dallas, Texas 75265  
Copyright © 2011, Texas Instruments Incorporated

[www.BDTIC.com/TI](http://www.BDTIC.com/TI)