

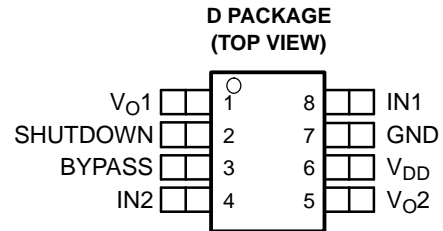

## 300-mW STEREO AUDIO POWER AMPLIFIER

- 300-mW Stereo Output
- PC Power Supply Compatibility 5-V and 3.3-V Specified Operation
- Shutdown Control
- Internal Midrail Generation
- Thermal and Short-Circuit Protection
- Surface-Mount Packaging
- Functional Equivalent of the LM4880



### DESCRIPTION

The TPA302 is a stereo audio power amplifier capable of delivering 250 mW of continuous average power into an 8-Ω load at less than 0.06% THD+N from a 5-V power supply or up to 300 mW at 1% THD+N. The TPA302 has high current outputs for driving small unpowered speakers at 8 Ω or headphones at 32 Ω. For headphone applications driving 32-Ω loads, the TPA302 delivers 60 mW of continuous average power at less than 0.06% THD+N. The amplifier features a shutdown function for power-sensitive applications as well as internal thermal and short-circuit protection. The amplifier is available in an 8-pin SOIC (D) package that reduces board space and facilitates automated assembly.

### TYPICAL APPLICATION CIRCUIT

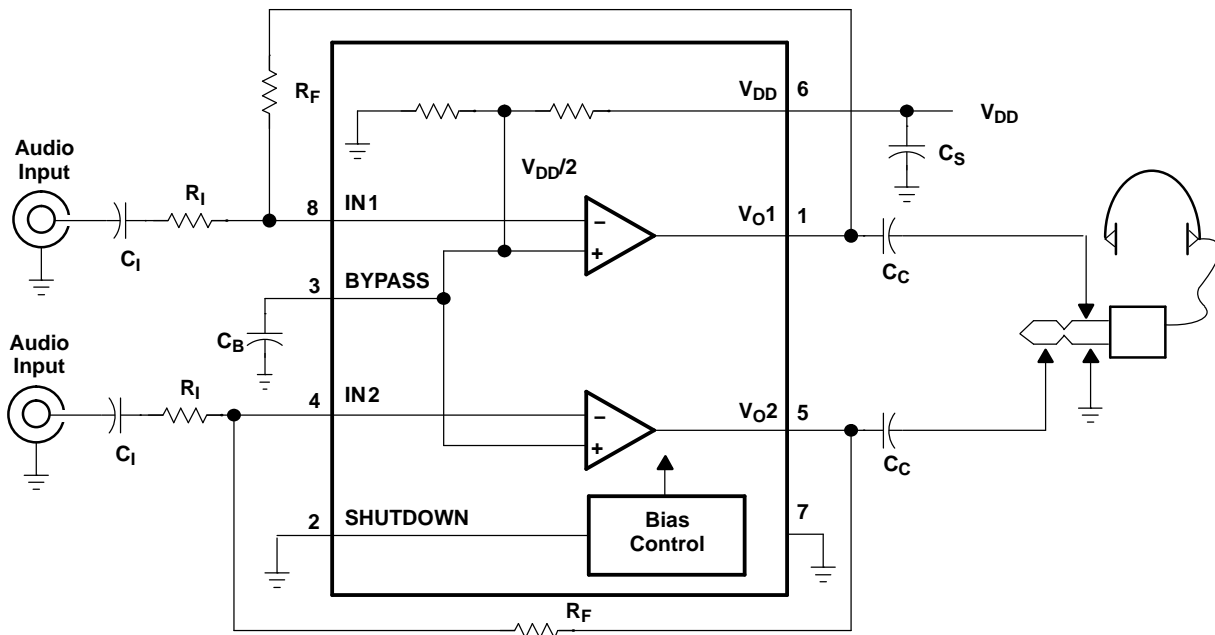

Please be aware that an important notice concerning availability, standard warranty, and use in critical applications of Texas Instruments semiconductor products and disclaimers thereto appears at the end of this data sheet.



This integrated circuit can be damaged by ESD. Texas Instruments recommends that all integrated circuits be handled with appropriate precautions. Failure to observe proper handling and installation procedures can cause damage.

ESD damage can range from subtle performance degradation to complete device failure. Precision integrated circuits may be more susceptible to damage because very small parametric changes could cause the device not to meet its published specifications.

**AVAILABLE OPTIONS**

$T_A$	<b>PACKAGED DEVICES</b>
	<b>SMALL OUTLINE<sup>(1)</sup> (D)</b>
-40°C to 85°C	TPA302D

(1) The D packages are available taped and reeled. To order a taped and reeled part, add the suffix R (e.g., TPA302DR)

**ABSOLUTE MAXIMUM RATINGS**

over operating free-air temperature range (unless otherwise noted)<sup>(1)</sup>

	<b>UNIT</b>
$V_{DD}$ Supply voltage	6 V
$V_I$ Input voltage	-0.3 V to $V_{DD} + 0.3$ V
Continuous total power dissipation	Internally limited (see Dissipation Rating Table)
$T_J$ Operating junction temperature range	-40°C to 150° C
$T_{stg}$ Storage temperature range	-65°C to 150°C
Lead temperature 1,6 mm (1/16 inch) from case for 10 seconds	260°C

(1) Stresses beyond those listed under "absolute maximum ratings" may cause permanent damage to the device. These are stress ratings only, and functional operation of the device at these or any other conditions beyond those indicated under "recommended operating conditions" is not implied. Exposure to absolute-maximum-rated conditions for extended periods may affect device reliability.

**DISSIPATION RATING TABLE**

<b>PACKAGE</b>	$T_A \leq 25^\circ\text{C}$ <b>POWER RATING</b>	<b>DERATING FACTOR</b> ABOVE $T_A = 25^\circ\text{C}$	$T_A = 70^\circ\text{C}$ <b>POWER RATING</b>	$T_A = 85^\circ\text{C}$ <b>POWER RATING</b>
D	731 mW	5.8 mW/°C	460 mW	380 mW

**RECOMMENDED OPERATING CONDITIONS**

	<b>MIN</b>	<b>MAX</b>	<b>UNIT</b>
$V_{DD}$ Supply voltage	2.7	5.5	V
$T_A$ Operating free-air temperature	-40	85	°C

**DC ELECTRICAL CHARACTERISTICS**

at specified free-air temperature,  $V_{DD} = 3.3$  V (unless otherwise noted)

<b>PARAMETER</b>	<b>TEST CONDITION</b>	<b>MIN</b>	<b>TYP</b>	<b>MAX</b>	<b>UNIT</b>
$I_{DD}$ Supply current			2.25	5	mA
$V_{IO}$ Input offset voltage			5	20	mV
PSRR Power supply rejection ratio	$V_{DD} = 3.2$ V to 3.4 V		55		dB
$I_{DD(SD)}$ Quiescent current in shutdown			0.6	20	µA

**AC OPERATING CHARACTERISTICS**
 $V_{DD} = 3.3\text{ V}$ ,  $T_A = 25^\circ\text{C}$ ,  $R_L = 8\ \Omega$  (unless otherwise noted)

PARAMETER		TEST CONDITION		MIN	TYP	MAX	UNIT
$P_O$	Output power	Gain = -1, f = 1 kHz	THD < 0.08%		100		mW
			THD < 1%		125		
			THD < 0.08%, $R_L = 32\ \Omega$		25		
			THD < 1%, $R_L = 32\ \Omega$		35		
$B_{OM}$	Maximum output power bandwidth	Gain = 10,	1% THD		20		kHz
$B_1$	Unity gain bandwidth	Open loop			1.5		MHz
	Channel separation	f = 1 kHz			75		dB
	Supply ripple rejection ratio	f = 1 kHz			45		dB
$V_n$	Noise output voltage	Gain = -1			10		$\mu\text{Vrms}$

**DC ELECTRICAL CHARACTERISTICS**

at specified free-air temperature,  $V_{DD} = 5\text{ V}$  (unless otherwise noted)

PARAMETER		TEST CONDITION	MIN	TYP	MAX	UNIT
$I_{DD}$	Supply current			4	10	mA
$V_{OO}$	Output offset voltage			5	20	mV
PSRR	Power supply rejection ratio	$V_{DD} = 4.9\text{ V to }5.1\text{ V}$		65		dB
$I_{DD(SD)}$	Quiescent current in shutdown			0.6		$\mu\text{A}$

**AC OPERATING CHARACTERISTICS**
 $V_{DD} = 5\text{ V}$ ,  $T_A = 25^\circ\text{C}$ ,  $R_L = 8\ \Omega$  (unless otherwise noted)

PARAMETER		TEST CONDITION		MIN	TYP	MAX	UNIT
$P_O$	Output power	Gain = -1, f = 1 kHz	THD < 0.06%		250		mW
			THD < 1%		300		
			THD < 0.06%, $R_L = 32\ \Omega$		60		
			THD < 1%, $R_L = 32\ \Omega$		80		
$B_{OM}$	Maximum output power bandwidth	Gain = 10,	1% THD		20		kHz
$B_1$	Unity gain bandwidth	Open loop			1.5		MHz
	Channel separation	f = 1 kHz			75		dB
	Supply ripple rejection ratio	f = 1 kHz			45		dB
$V_n$	Noise output voltage	Gain = -1			10		$\mu\text{Vrms}$

TYPICAL APPLICATION

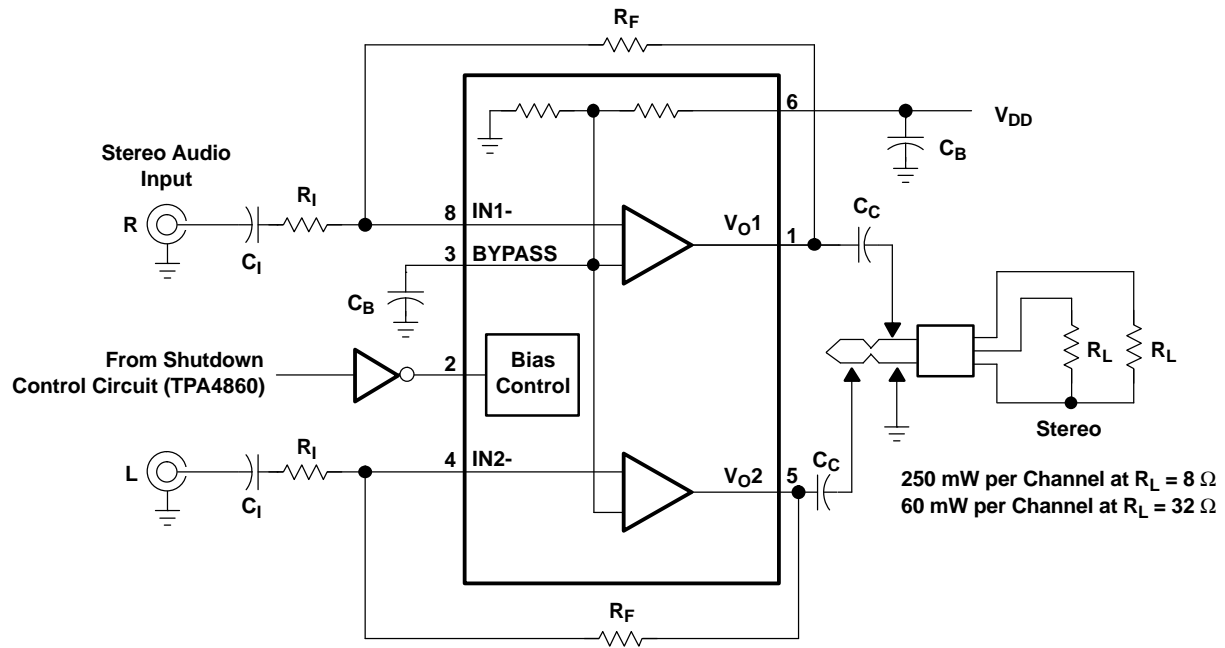

**TYPICAL CHARACTERISTICS**

**Table of Graphs**

		<b>FIGURE</b>	
THD+N	Total harmonic distortion plus noise	vs Frequency	1-3, 7-9, 13-15, 19-21
		vs Output power	4-6, 10-12 16-18, 22-24
I <sub>DD</sub>	Supply current	vs Supply voltage	25
		vs Free-air temperature	26
V <sub>n</sub>	Output noise voltage	vs Frequency	27, 28
		Maximum package power dissipation	vs Free-air temperature
	Power dissipation	vs Output power	30, 31
P <sub>Omax</sub>	Maximum output power	vs Free-air temperature	32, 33
P <sub>O</sub>	Output power	vs Load resistance	34
		vs Supply voltage	35
	Open-loop response		36
	Closed-loop response		37
	Crosstalk	vs Frequency	38, 39
	Supply ripple rejection ratio	vs Frequency	40, 41

**TOTAL HARMONIC DISTORTION + NOISE  
vs  
FREQUENCY**

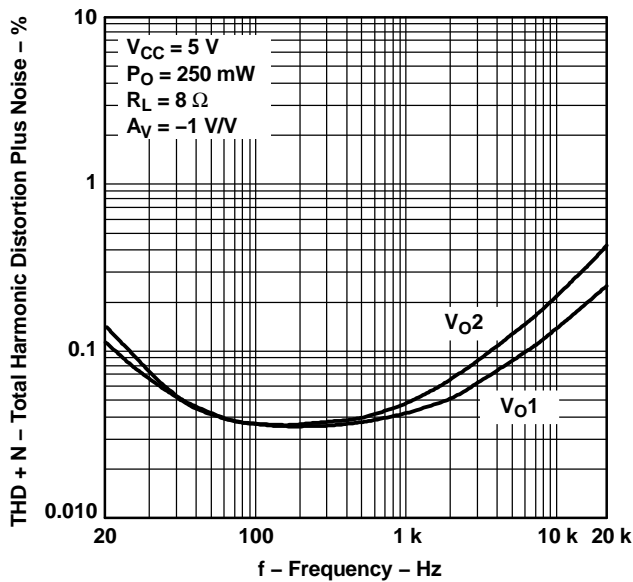

Figure 1.

**TOTAL HARMONIC DISTORTION + NOISE  
vs  
FREQUENCY**

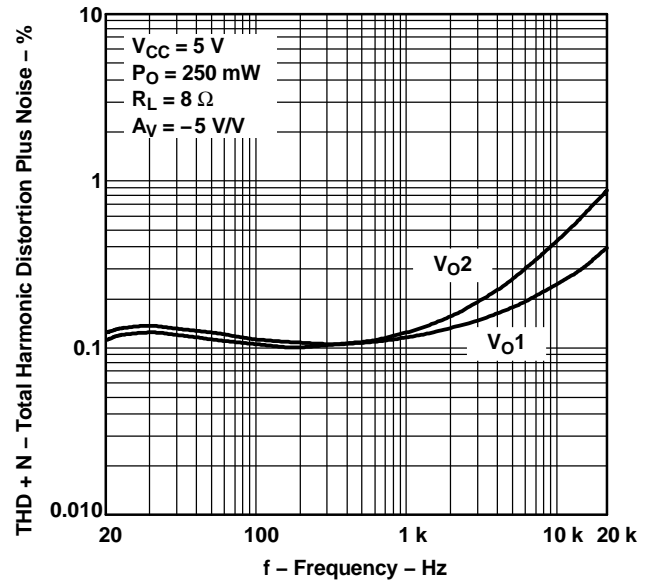

Figure 2.

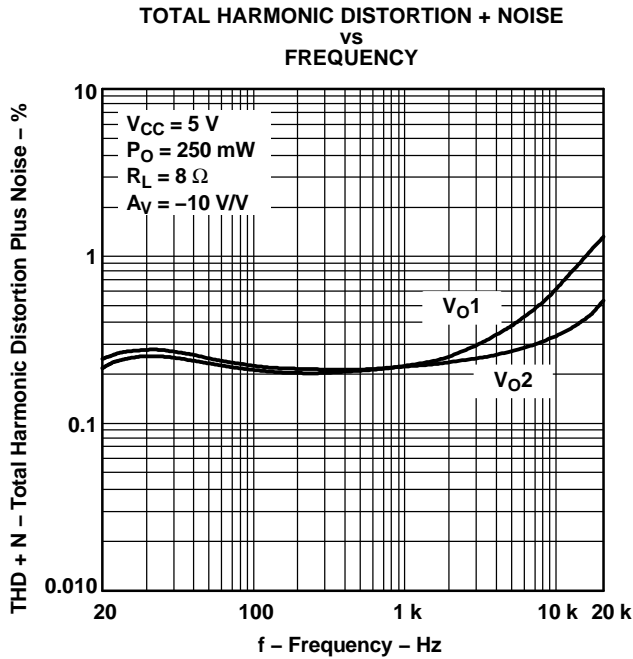

Figure 3.

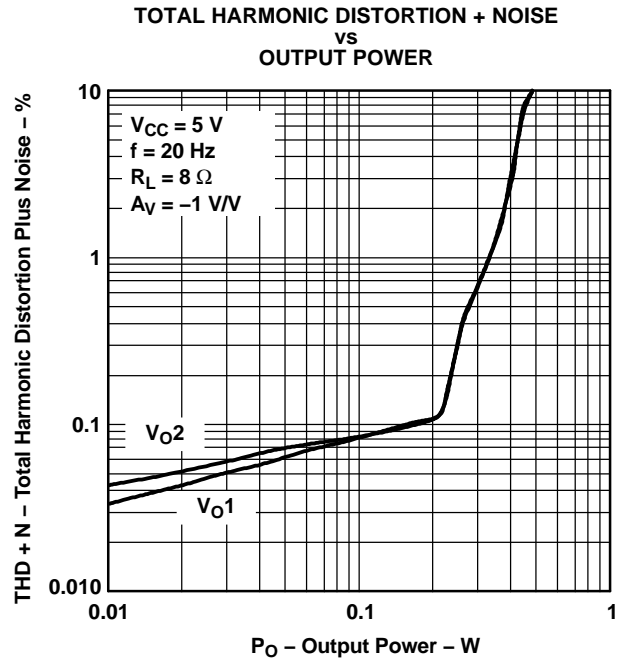

Figure 4.

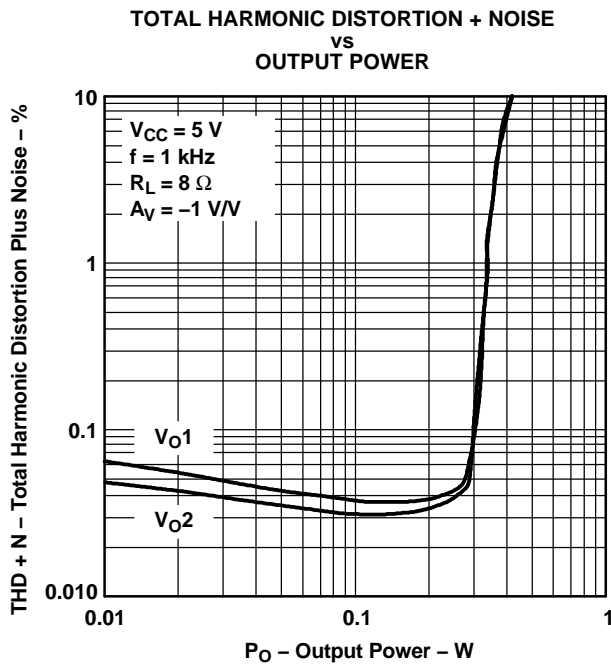

Figure 5.

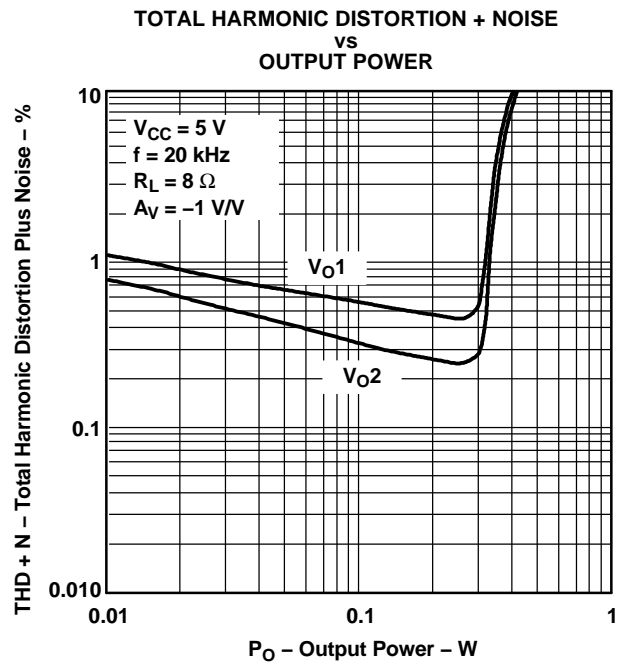

Figure 6.

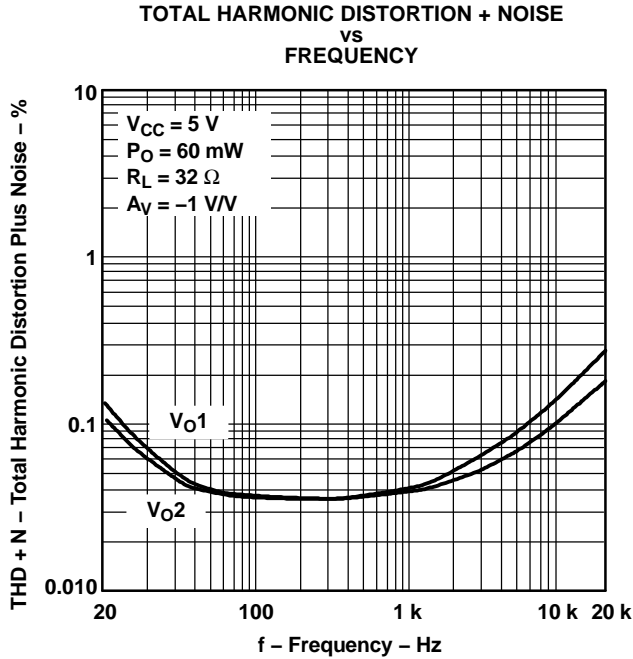

Figure 7.

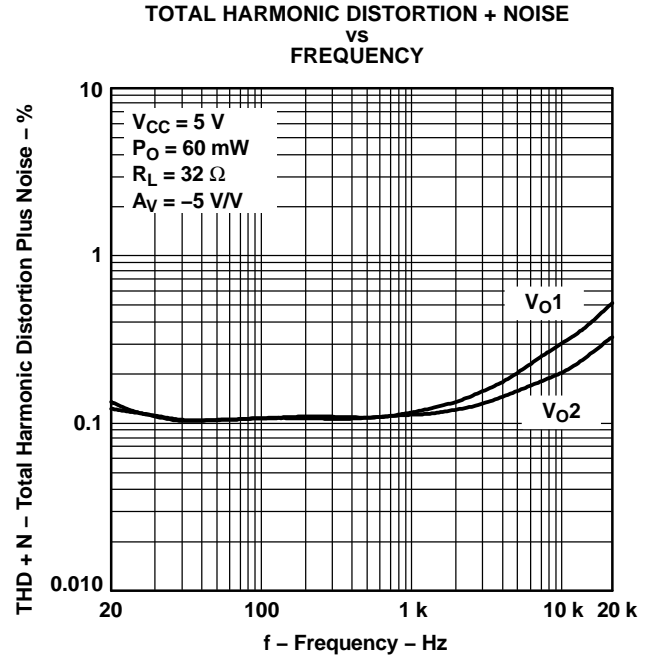

Figure 8.

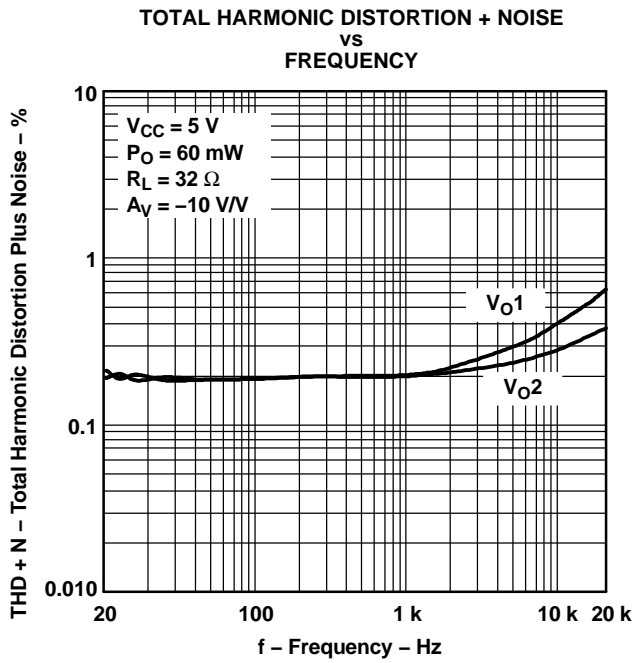

Figure 9.

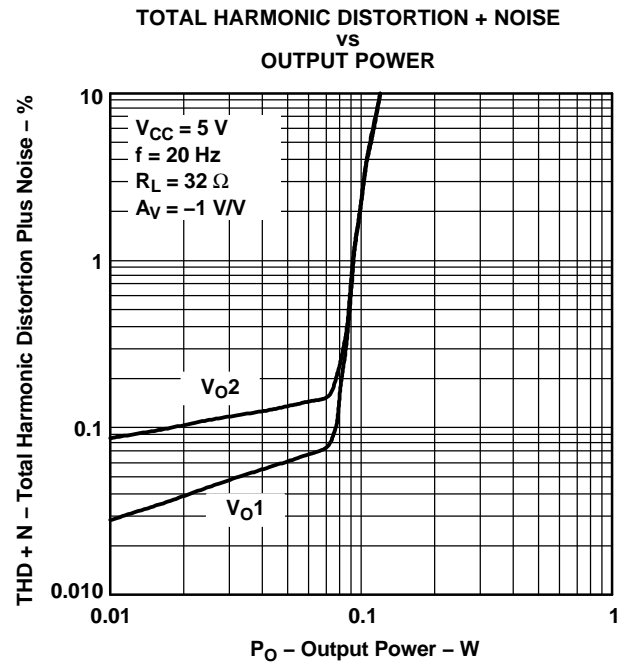

Figure 10.

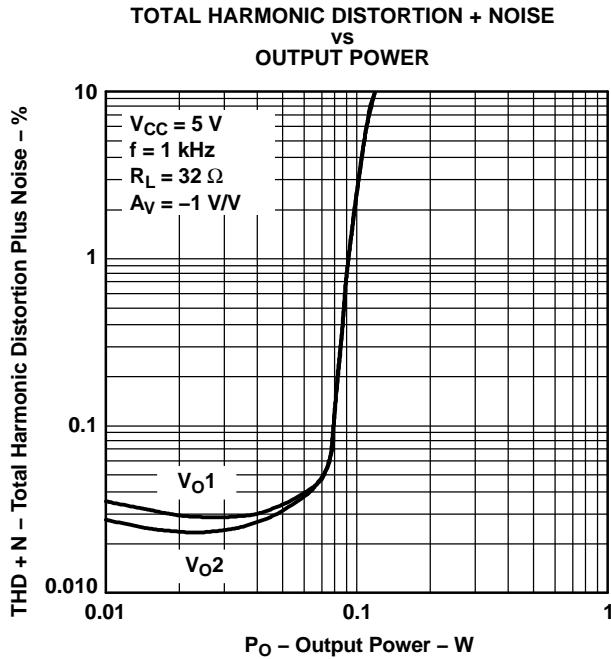

Figure 11.

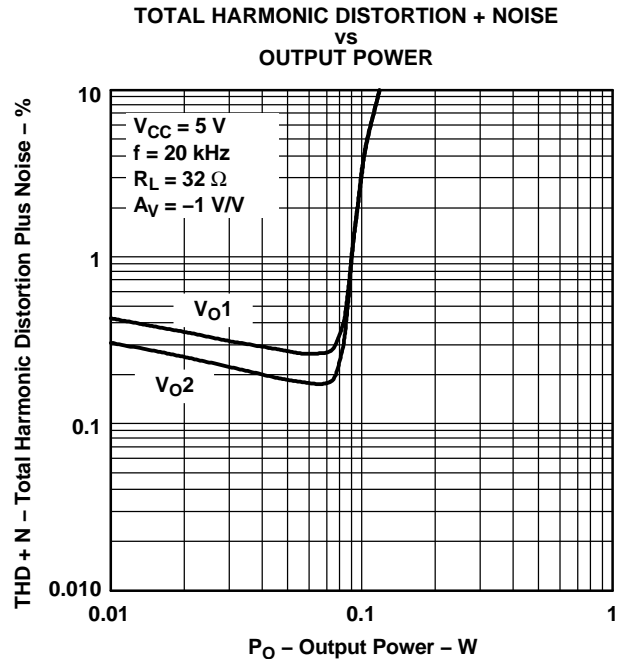

Figure 12.

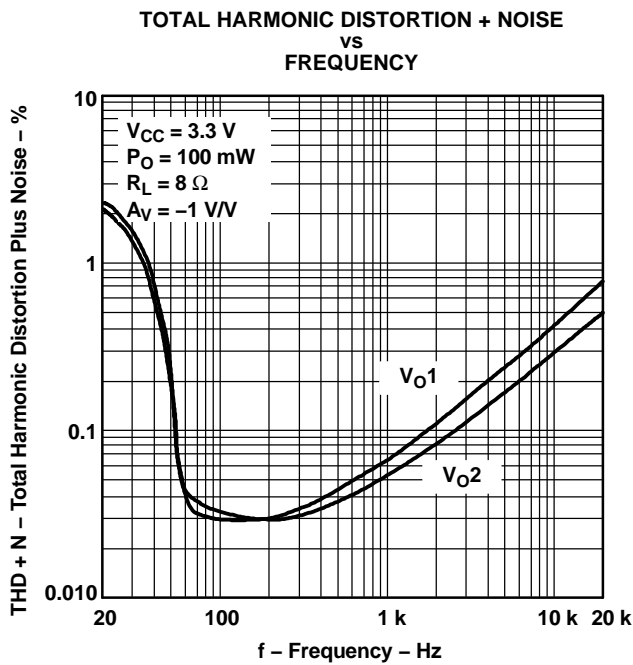

Figure 13.

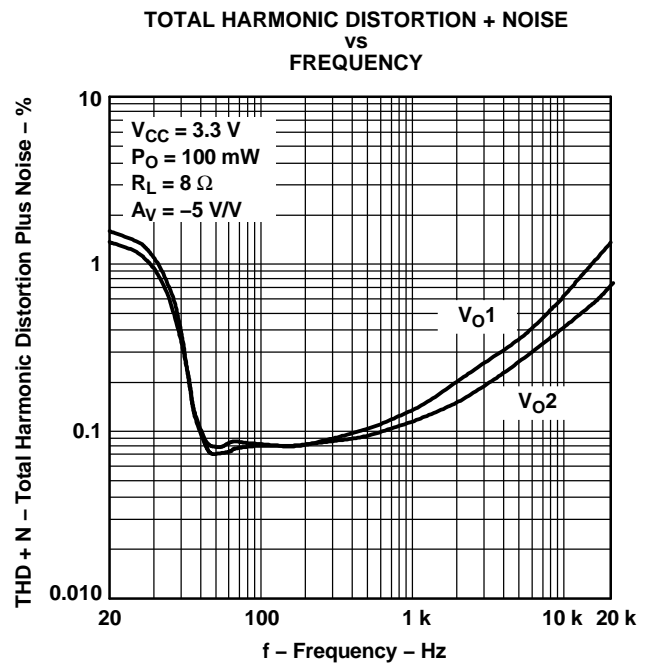

Figure 14.



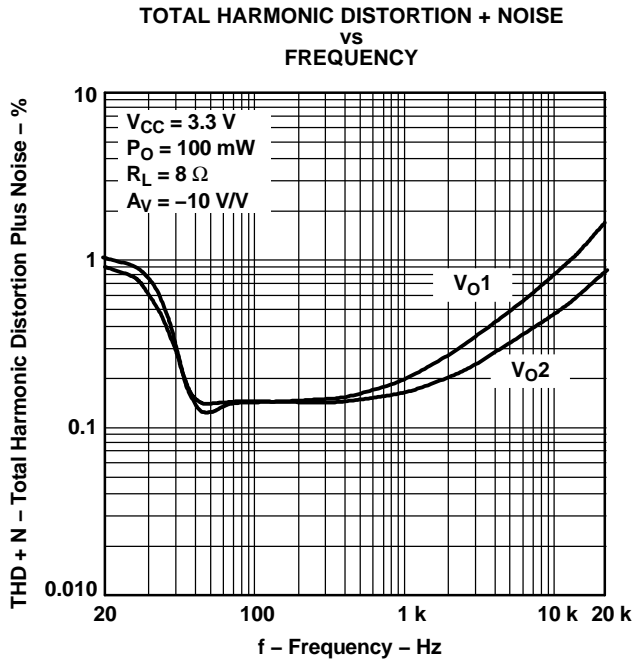

Figure 15.

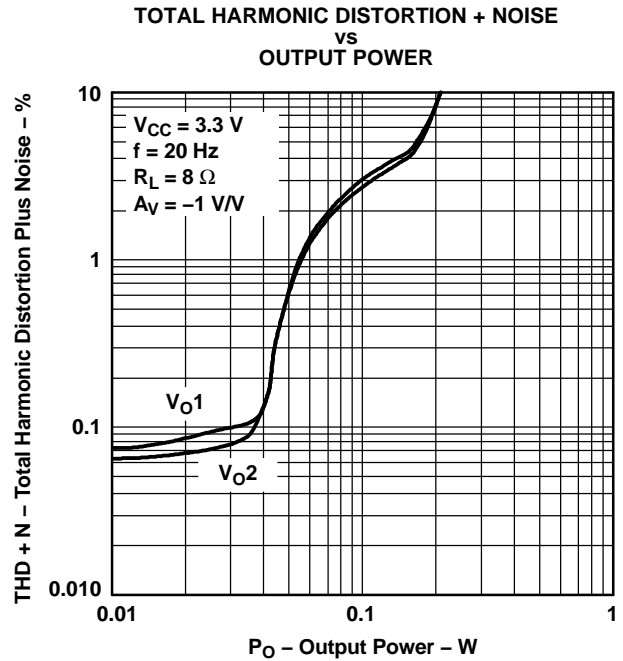

Figure 16.

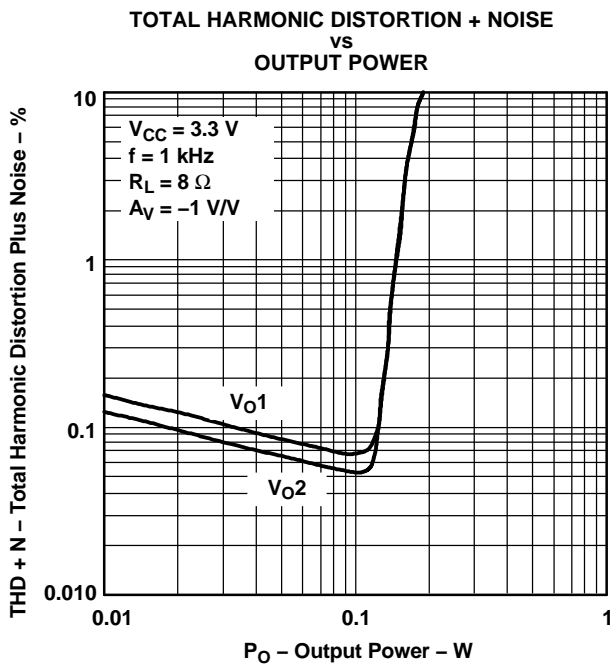

Figure 17.

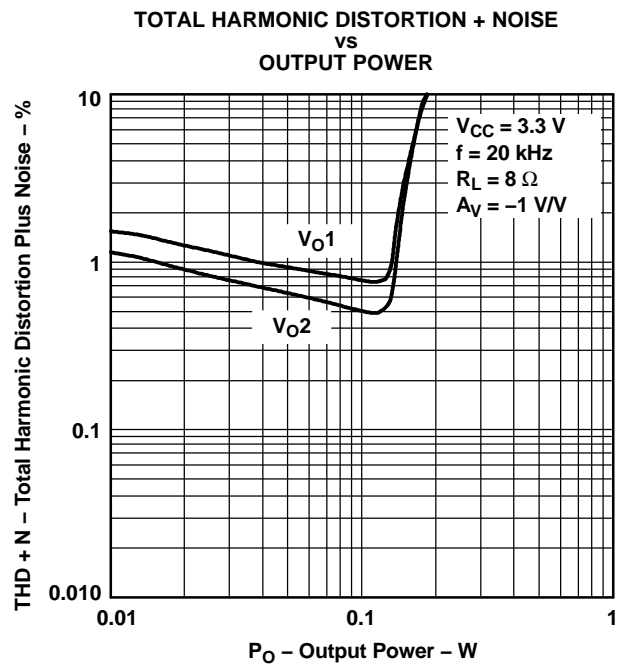

Figure 18.

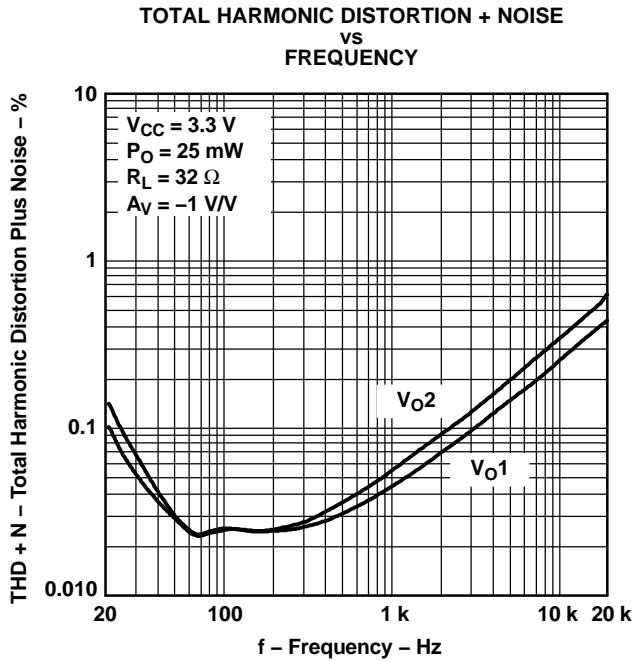

Figure 19.

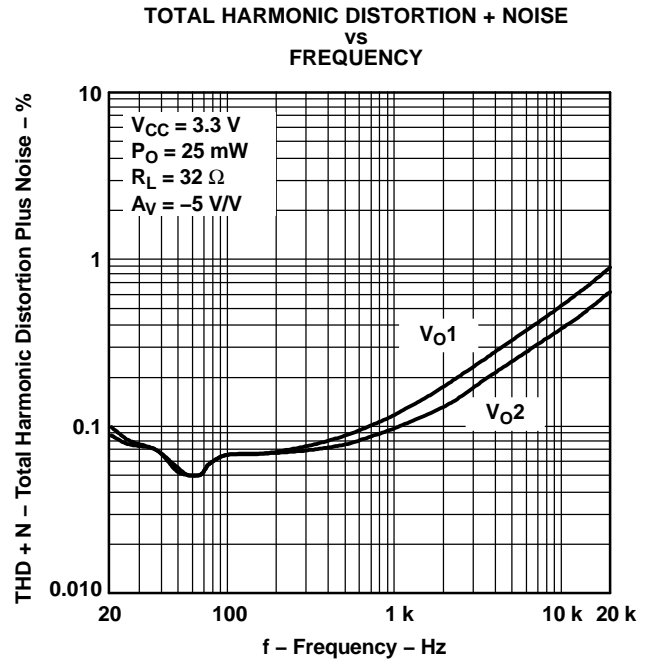

Figure 20.

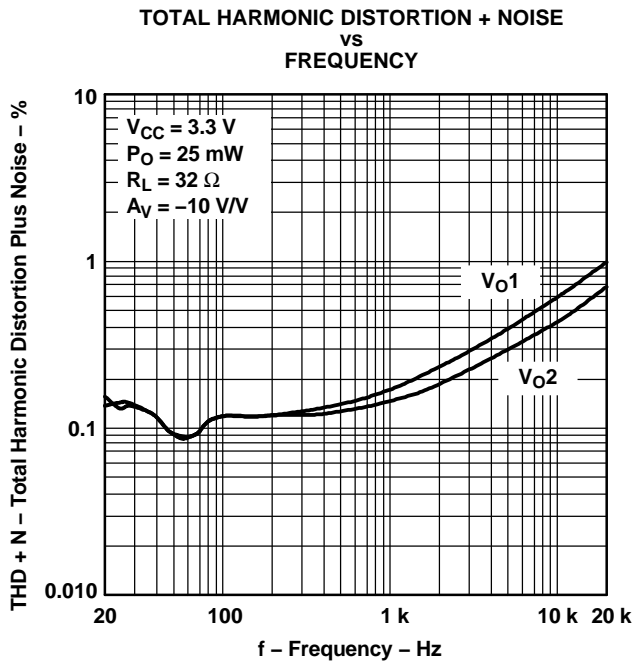

Figure 21.

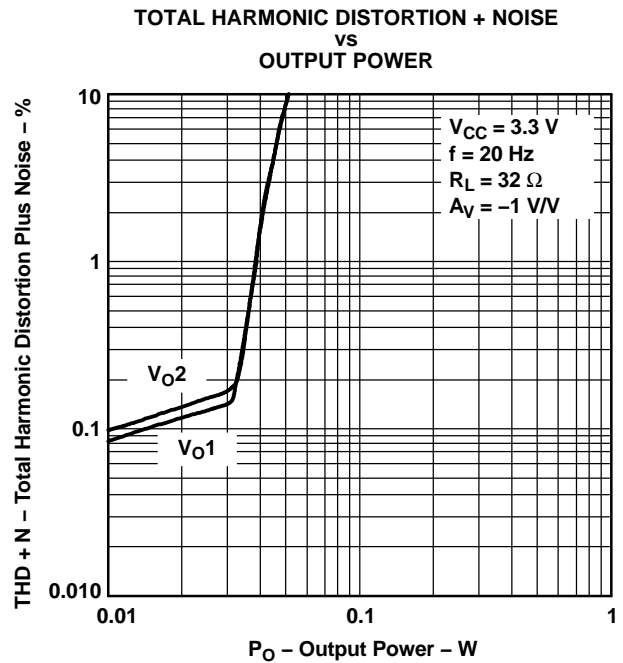

Figure 22.

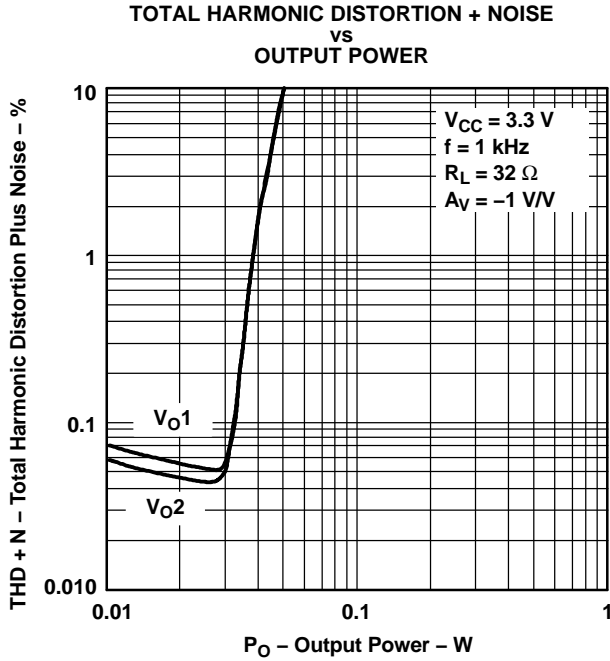

Figure 23.

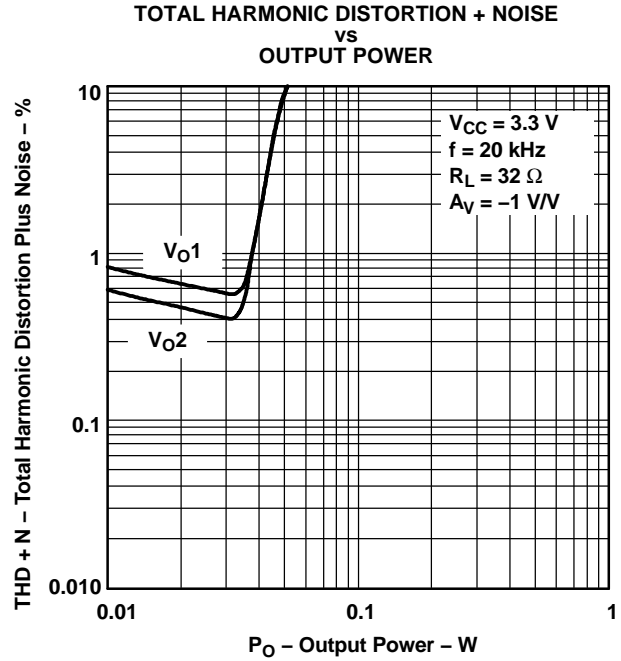

Figure 24.

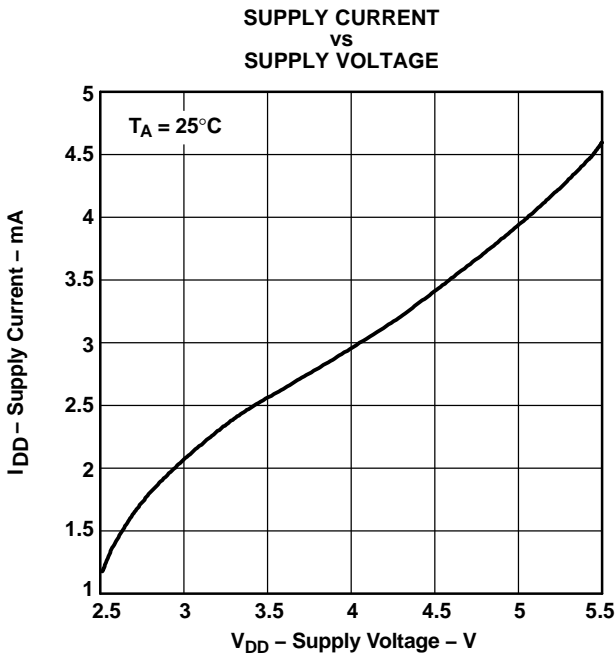

Figure 25.

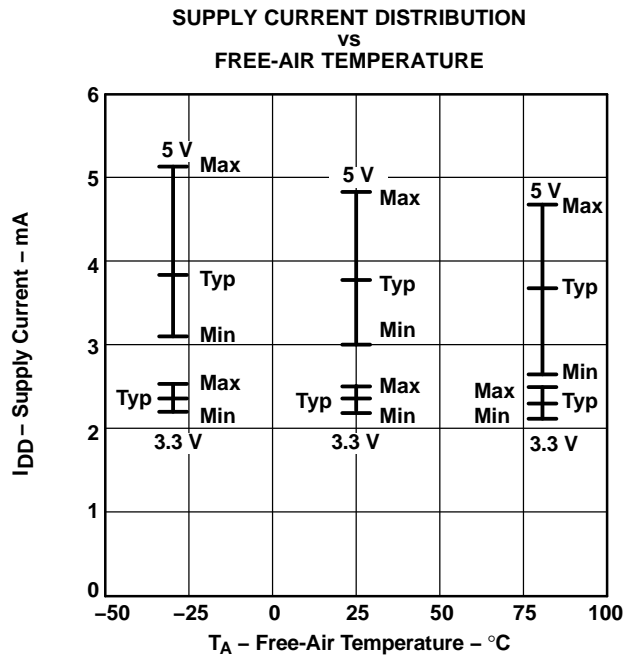

Figure 26.

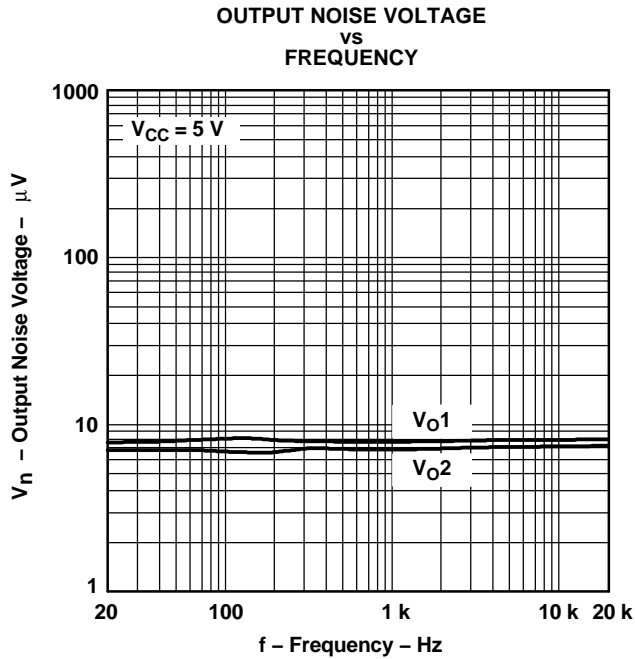

Figure 27.

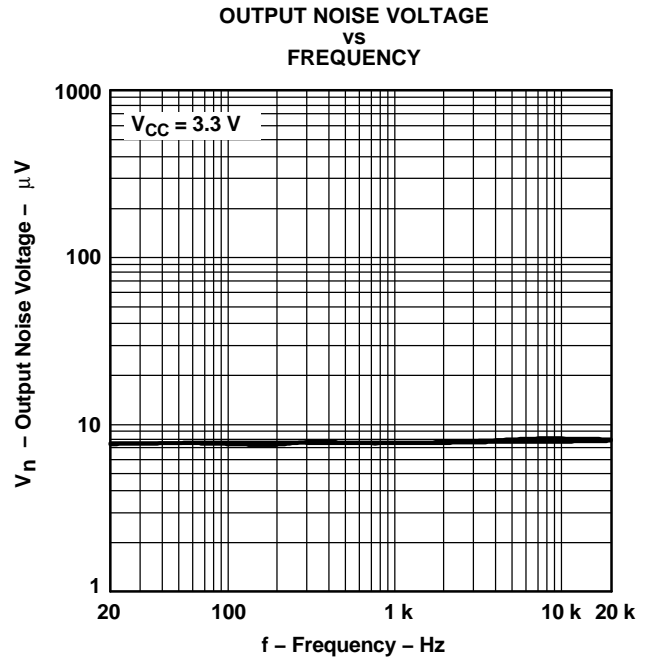

Figure 28.

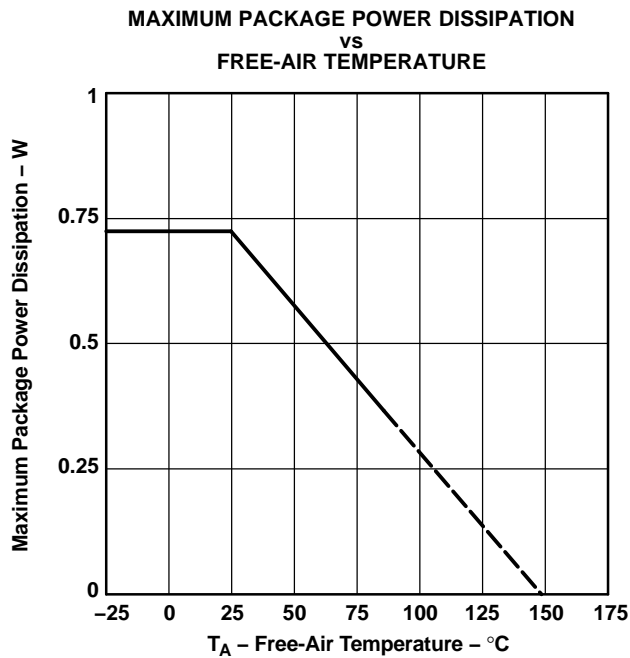

Figure 29.

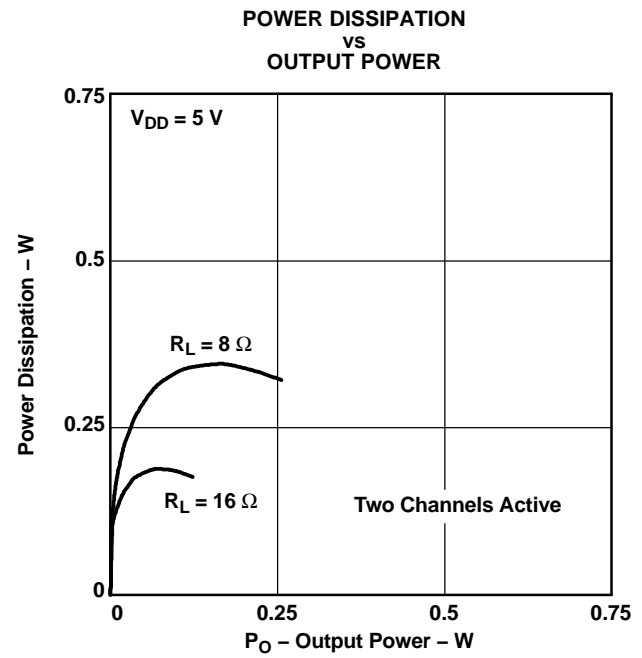

Figure 30.

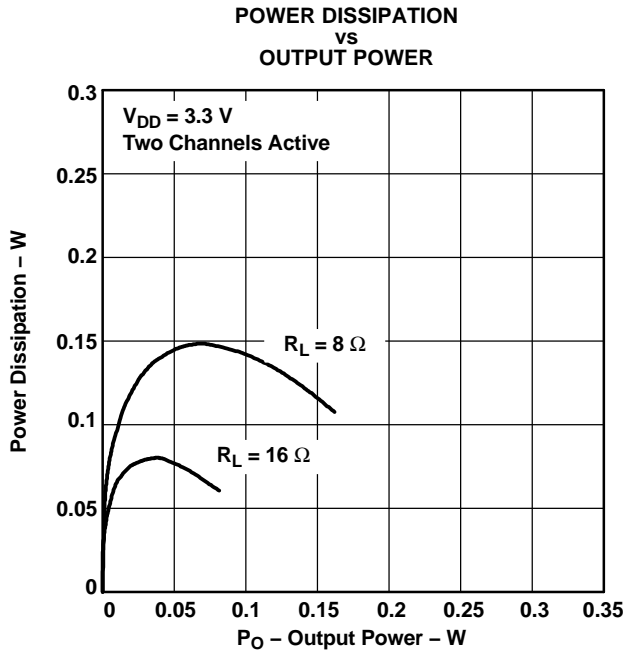

Figure 31.

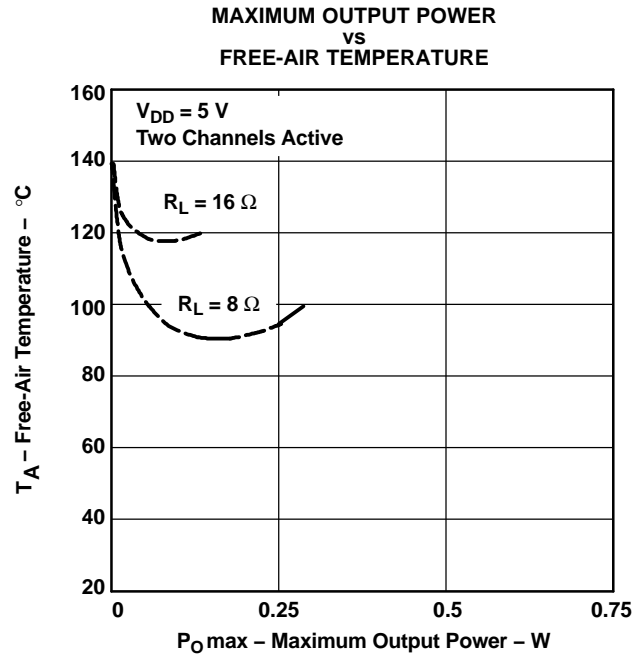

Figure 32.

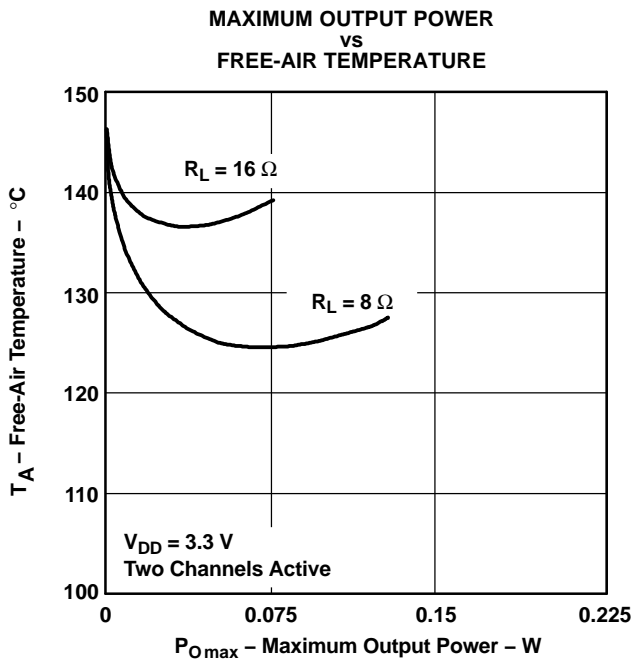

Figure 33.

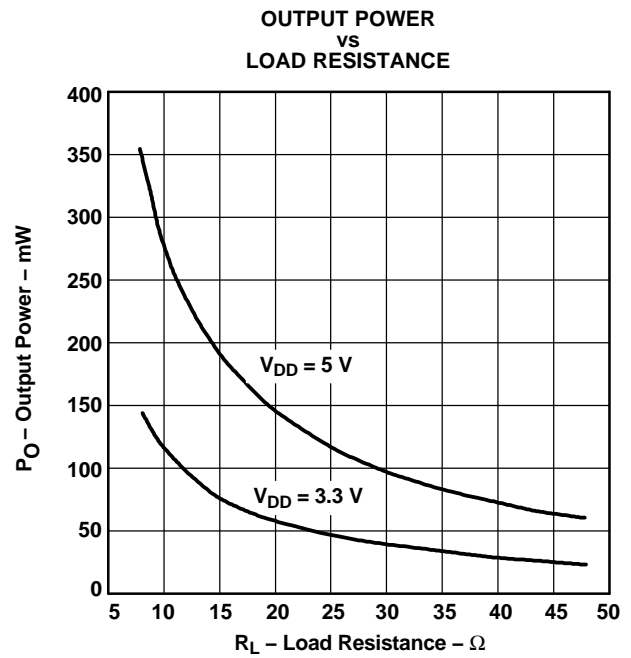

Figure 34.

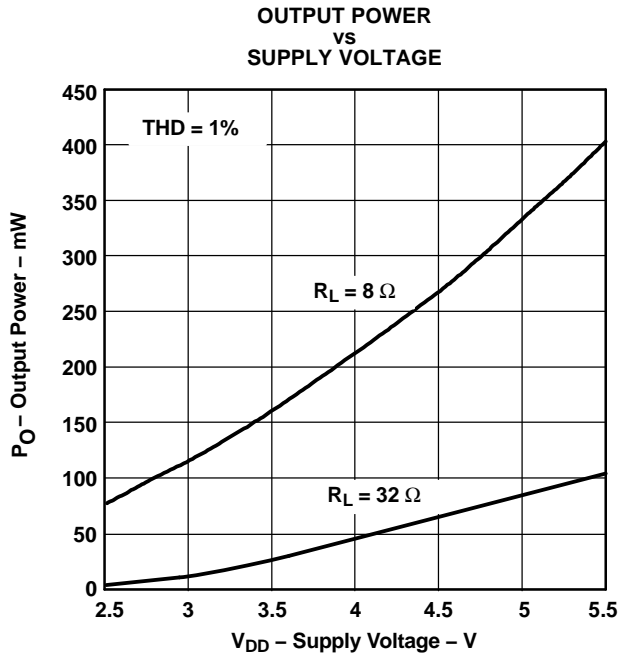

Figure 35.

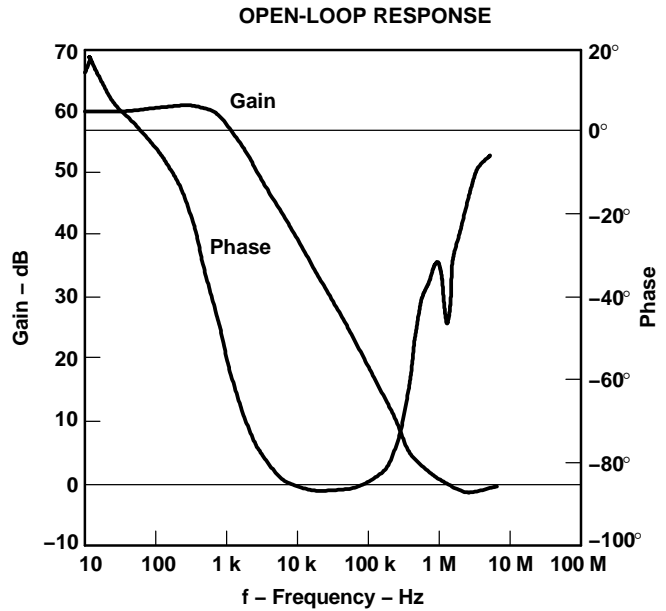

Figure 36.

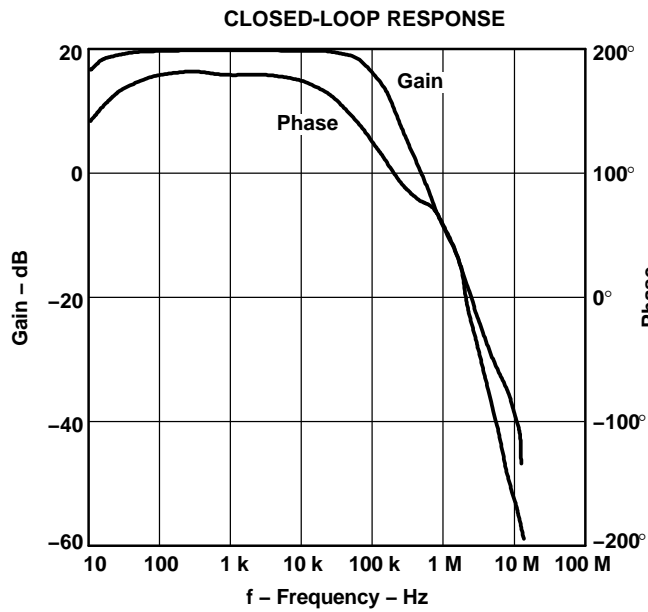

Figure 37.

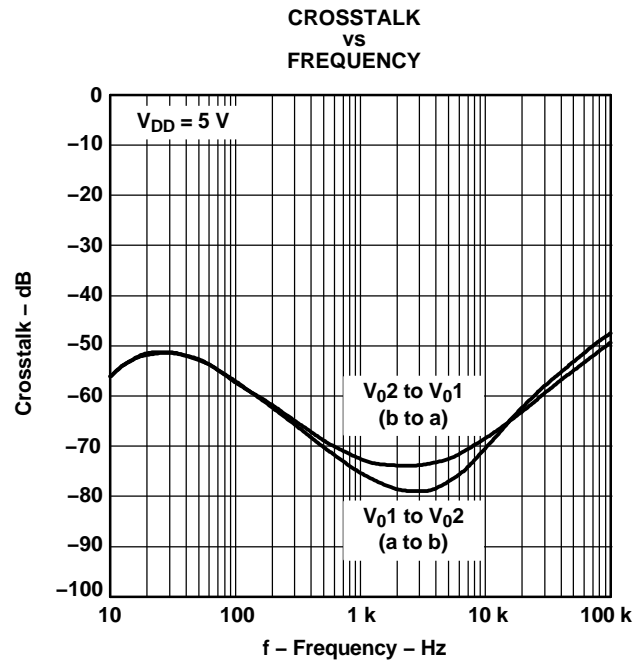

Figure 38.

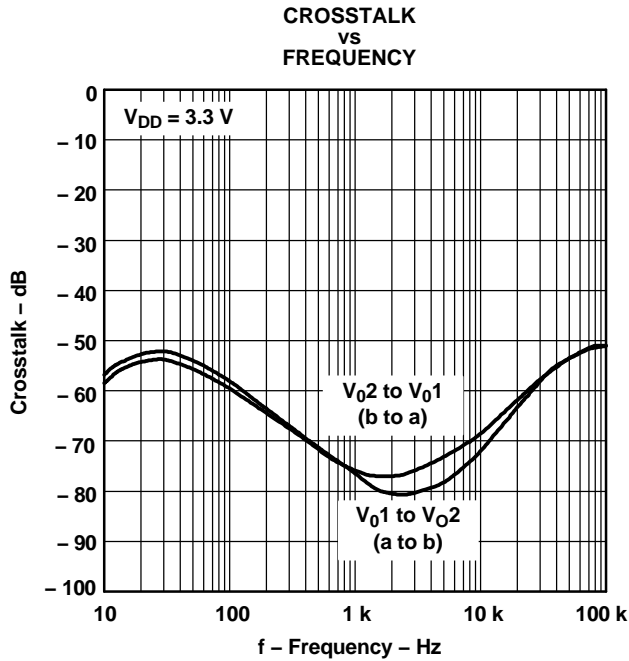

Figure 39.

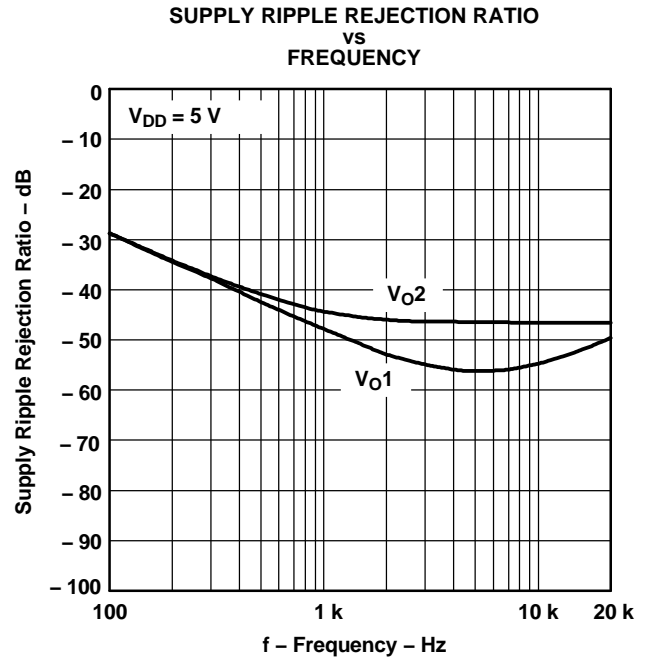

Figure 40.

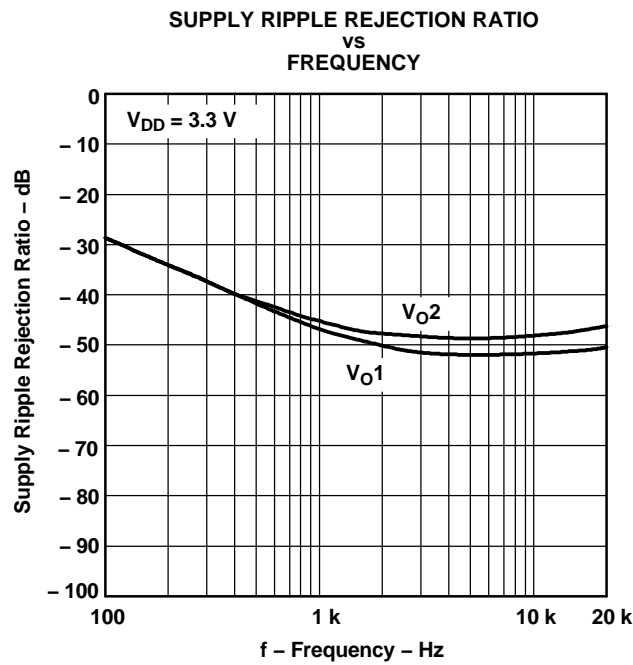
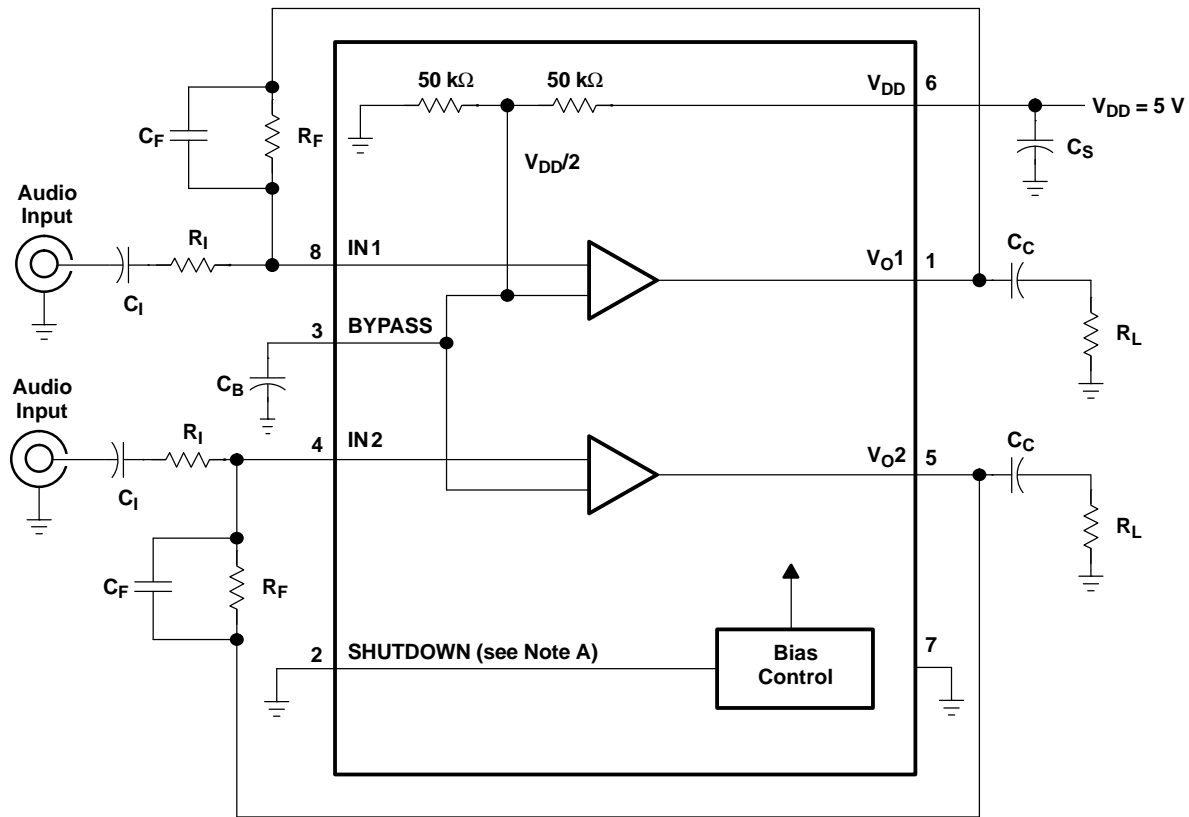

Figure 41.

APPLICATION INFORMATION

SELECTION OF COMPONENTS

Figure 42 is a schematic diagram of a typical application circuit.



NOTE A: SHUTDOWN must be held low for normal operation and asserted high for shutdown mode.

Figure 42. TPA302 Typical Notebook Computer Application Circuit

Gain Setting Resistors,  $R_F$  and  $R_I$

The gain for the TPA302 is set by resistors  $R_F$  and  $R_I$  according to Equation 1.

$$\text{Gain} \leq \times \left( \frac{R_F}{R_I} \right) \tag{1}$$

Given that the TPA302 is an MOS amplifier, the input impedance is high; consequently, input leakage currents are not generally a concern, although noise in the circuit increases as the value of  $R_F$  increases. In addition, a certain range of  $R_F$  values is required for proper start-up operation of the amplifier. Taken together, it is recommended that the effective impedance seen by the inverting node of the amplifier be set between 5 kΩ and 20 kΩ. The effective impedance is calculated in Equation 2.

$$\text{Effective Impedance} \leq \frac{R_F R_I}{R_F + R_I} \tag{2}$$

As an example, consider an input resistance of 10 kΩ and a feedback resistor of 50 kΩ. The gain of the amplifier would be  $-5$  and the effective impedance at the inverting terminal would be 8.3 kΩ, which is within the recommended range.



## APPLICATION INFORMATION (continued)

For high-performance applications, metal film resistors are recommended because they tend to have lower noise levels than carbon resistors. For values of  $R_F$  above 50 k $\Omega$ , the amplifier tends to become unstable due to a pole formed from  $R_F$  and the inherent input capacitance of the MOS input structure. For this reason, a small compensation capacitor of approximately 5 pF should be placed in parallel with  $R_F$ . In effect, this creates a low-pass filter network with the cutoff frequency defined in Equation 3.

$$f_{c(\text{lowpass})} \times \frac{1}{2\pi R_F C_F} \quad (3)$$

For example, if  $R_F$  is 100 k $\Omega$  and  $C_F$  is 5 pF, then  $f_{c(\text{lowpass})}$  is 318 kHz, which is well outside of the audio range.

### Input Capacitor, $C_I$

In the typical application, input capacitor  $C_I$  is required to allow the amplifier to bias the input signal to the proper dc level for optimum operation. In this case,  $C_I$  and  $R_I$  form a high-pass filter with the corner frequency determined in Equation 4.

$$f_{c(\text{highpass})} \times \frac{1}{2\pi R_I C_I} \quad (4)$$

The value of  $C_I$  is important to consider as it directly affects the bass (low-frequency) performance of the circuit. Consider the example where  $R_I$  is 10 k $\Omega$  and the specification calls for a flat bass response down to 40 Hz. Equation 4 is reconfigured as Equation 5.

$$C_I \times \frac{1}{2\pi R_I f_{c(\text{highpass})}} \quad (5)$$

In this example,  $C_I$  is 0.4  $\mu\text{F}$ ; so, one would likely choose a value in the range of 0.47  $\mu\text{F}$  to 1  $\mu\text{F}$ . A further consideration for this capacitor is the leakage path from the input source through the input network ( $R_I$ ,  $C_I$ ) and the feedback resistor ( $R_F$ ) to the load. This leakage current creates a dc offset voltage at the input to the amplifier that reduces useful headroom, especially in high-gain applications (>10). For this reason, a low-leakage tantalum or ceramic capacitor is the best choice. When polarized capacitors are used, the positive side of the capacitor should face the amplifier input in most applications as the dc level there is held at  $V_{DD}/2$ , which is likely higher than the source dc level. Note that it is important to confirm the capacitor polarity in the application.

### Power Supply Decoupling, $C_S$

The TPA302 is a high-performance CMOS audio amplifier that requires adequate power supply decoupling to ensure that the output total harmonic distortion (THD) is as low as possible. Power supply decoupling also prevents oscillations for long lead lengths between the amplifier and the speaker. The optimum decoupling is achieved by using two capacitors of different types that target different types of noise on the power supply leads. For higher frequency transients, spikes, or digital hash on the line, a good low equivalent-series-resistance (ESR) ceramic capacitor, typically 0.1  $\mu\text{F}$ , placed as close as possible to the device  $V_{DD}$  lead, works best. For filtering lower frequency noise signals, a larger aluminum electrolytic capacitor of 10  $\mu\text{F}$  or greater placed near the power amplifier is recommended.

### Midrail Bypass Capacitor, $C_B$

The midrail bypass capacitor,  $C_B$ , serves several important functions. During startup or recovery from shutdown mode,  $C_B$  determines the rate at which the amplifier starts up. This helps to push the start-up pop noise into the subaudible range (so low it cannot be heard). The second function is to reduce noise produced by the power supply caused by coupling into the output drive signal. This noise is from the midrail generation circuit internal to the amplifier. The capacitor is fed from a 25-k $\Omega$  source inside the amplifier. To keep the start-up pop as low as possible, the relationship shown in Equation 6 should be maintained.

$$\frac{1}{C_B \times 25 \text{ k}\Omega} \leq \frac{1}{C_I R_I} \quad (6)$$

As an example, consider a circuit where  $C_B$  is 0.1  $\mu\text{F}$ ,  $C_I$  is 0.22  $\mu\text{F}$  and  $R_I$  is 10 k $\Omega$ . Inserting these values into Equation 6 results in:  $400 \leq 454$  which satisfies the rule. Recommended values for bypass capacitor  $C_B$  are 0.1- $\mu\text{F}$  to 1- $\mu\text{F}$ , ceramic or tantalum low-ESR, for the best THD and noise performance.

**APPLICATION INFORMATION (continued)****OUTPUT COUPLING CAPACITOR,  $C_C$** 

In the typical single-supply, single-ended (SE) configuration, an output coupling capacitor ( $C_C$ ) is required to block the dc bias at the output of the amplifier thus preventing dc currents in the load. As with the input coupling capacitor, the output coupling capacitor and impedance of the load form a high-pass filter governed by Equation 7.

$$f_c \times \frac{1}{2\pi R_L C_C} \quad (7)$$

The main disadvantage, from a performance standpoint, is that the load impedances are typically small, which drives the low-frequency corner higher. Large values of  $C_C$  are required to pass low frequencies into the load. Consider the example where a  $C_C$  of 68  $\mu\text{F}$  is chosen and loads vary from 8  $\Omega$ , 32  $\Omega$ , and 47 k $\Omega$ . Table 1 summarizes the frequency response characteristics of each configuration.

**Table 1. Common Load Impedances vs Low Frequency Output Characteristics in SE Mode**

$R_L$	$C_C$	LOWEST FREQUENCY
8 $\Omega$	68 $\mu\text{F}$	293 Hz
32 $\Omega$	68 $\mu\text{F}$	73 Hz
47,000 $\Omega$	68 $\mu\text{F}$	0.05 Hz

As Table 1 indicates, most of the bass response is attenuated into 8- $\Omega$  loads while headphone response is adequate and drive into line level inputs (a home stereo for example) is good.

The output coupling capacitor required in single-supply, SE mode also places additional constraints on the selection of other components in the amplifier circuit. The rules described previously still hold with the addition of the following relationship:

$$\frac{1}{C_B \times 25 \text{ k}\Omega} \leq \frac{1}{C_I R_I} \ll \frac{1}{R_L C_C} \quad (8)$$

**SHUTDOWN MODE**

The TPA302 employs a shutdown mode of operation designed to reduce quiescent supply current,  $I_{DD(q)}$ , to the absolute minimum level during periods of nonuse for battery-power conservation. For example, during device sleep modes or when other audio-drive currents are used (i.e., headphone mode), the speaker drive is not required. The SHUTDOWN input terminal should be held low during normal operation when the amplifier is in use. Pulling SHUTDOWN high causes the outputs to mute and the amplifier to enter a low-current state,  $I_{DD} \sim 0.6 \mu\text{A}$ . SHUTDOWN should never be left unconnected because amplifier operation would be unpredictable.

**USING LOW-ESR CAPACITORS**

Low-ESR capacitors are recommended throughout this applications section. A real capacitor can be modeled simply as a resistor in series with an ideal capacitor. The voltage drop across this resistor minimizes the beneficial effects of the capacitor in the circuit. The lower the equivalent value of this resistance the more the real capacitor behaves like an ideal capacitor.

## THERMAL CONSIDERATIONS

A prime consideration when designing an audio amplifier circuit is internal power dissipation in the device. The curve in Figure 43 provides an easy way to determine what output power can be expected out of the TPA302 for a given system ambient temperature in designs using 5-V supplies. This curve assumes no forced airflow or additional heat sinking.

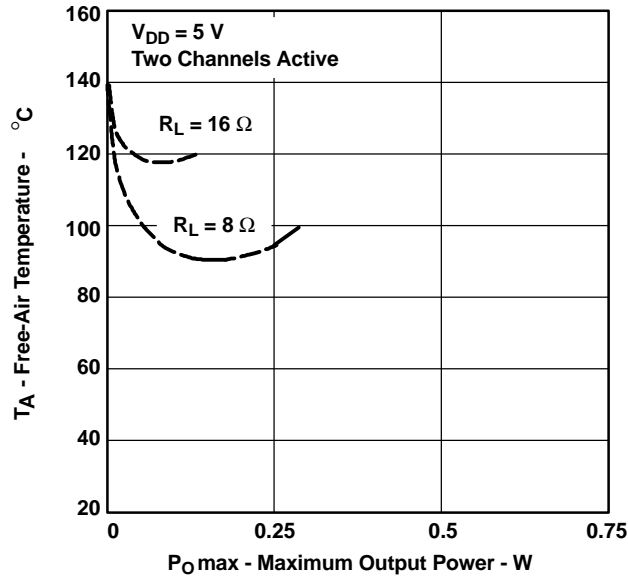

Figure 43. Free-Air Temperature Versus Maximum Output Power

## 5-V VERSUS 3.3-V OPERATION

The TPA302 was designed for operation over a supply range of 2.7 V to 5.5 V. This data sheet provides full specifications for 5-V and 3.3-V operation because they are considered to be the two most common standard voltages. There are no special considerations for 3.3-V versus 5-V operation as far as supply bypassing, gain setting, or stability. Supply current is slightly reduced from 4 mA (typical) to 2.25 mA (typical). The most important consideration is that of output power. Each amplifier in the TPA302 can produce a maximum voltage swing of  $V_{DD} - 1$  V. This means, for 3.3-V operation, clipping starts to occur when  $V_{O(PP)} = 2.3$  V as opposed when  $V_{O(PP)} = 4$  V while operating at 5 V. The reduced voltage swing subsequently reduces maximum output power into the load before distortion begins to become significant.

**PACKAGING INFORMATION**

Orderable Device	Status <sup>(1)</sup>	Package Type	Package Drawing	Pins	Package Qty	Eco Plan <sup>(2)</sup>	Lead/Ball Finish	MSL Peak Temp <sup>(3)</sup>
TPA302D	ACTIVE	SOIC	D	8	75	Green (RoHS & no Sb/Br)	CU NIPDAU	Level-1-260C-UNLIM
TPA302DG4	ACTIVE	SOIC	D	8	75	Green (RoHS & no Sb/Br)	CU NIPDAU	Level-1-260C-UNLIM
TPA302DR	ACTIVE	SOIC	D	8	2500	Green (RoHS & no Sb/Br)	CU NIPDAU	Level-1-260C-UNLIM
TPA302DRG4	ACTIVE	SOIC	D	8	2500	Green (RoHS & no Sb/Br)	CU NIPDAU	Level-1-260C-UNLIM

<sup>(1)</sup> The marketing status values are defined as follows:

**ACTIVE:** Product device recommended for new designs.

**LIFEBUY:** TI has announced that the device will be discontinued, and a lifetime-buy period is in effect.

**NRND:** Not recommended for new designs. Device is in production to support existing customers, but TI does not recommend using this part in a new design.

**PREVIEW:** Device has been announced but is not in production. Samples may or may not be available.

**OBSOLETE:** TI has discontinued the production of the device.

<sup>(2)</sup> Eco Plan - The planned eco-friendly classification: Pb-Free (RoHS), Pb-Free (RoHS Exempt), or Green (RoHS & no Sb/Br) - please check <http://www.ti.com/productcontent> for the latest availability information and additional product content details.

**TBD:** The Pb-Free/Green conversion plan has not been defined.

**Pb-Free (RoHS):** TI's terms "Lead-Free" or "Pb-Free" mean semiconductor products that are compatible with the current RoHS requirements for all 6 substances, including the requirement that lead not exceed 0.1% by weight in homogeneous materials. Where designed to be soldered at high temperatures, TI Pb-Free products are suitable for use in specified lead-free processes.

**Pb-Free (RoHS Exempt):** This component has a RoHS exemption for either 1) lead-based flip-chip solder bumps used between the die and package, or 2) lead-based die adhesive used between the die and leadframe. The component is otherwise considered Pb-Free (RoHS compatible) as defined above.

**Green (RoHS & no Sb/Br):** TI defines "Green" to mean Pb-Free (RoHS compatible), and free of Bromine (Br) and Antimony (Sb) based flame retardants (Br or Sb do not exceed 0.1% by weight in homogeneous material)

<sup>(3)</sup> MSL, Peak Temp. -- The Moisture Sensitivity Level rating according to the JEDEC industry standard classifications, and peak solder temperature.

**Important Information and Disclaimer:**The information provided on this page represents TI's knowledge and belief as of the date that it is provided. TI bases its knowledge and belief on information provided by third parties, and makes no representation or warranty as to the accuracy of such information. Efforts are underway to better integrate information from third parties. TI has taken and continues to take reasonable steps to provide representative and accurate information but may not have conducted destructive testing or chemical analysis on incoming materials and chemicals. TI and TI suppliers consider certain information to be proprietary, and thus CAS numbers and other limited information may not be available for release.

In no event shall TI's liability arising out of such information exceed the total purchase price of the TI part(s) at issue in this document sold by TI to Customer on an annual basis.

**TAPE AND REEL INFORMATION**

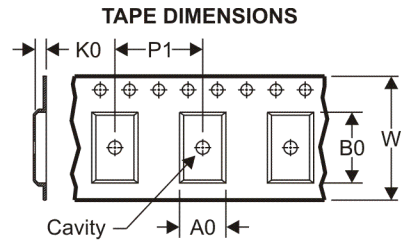
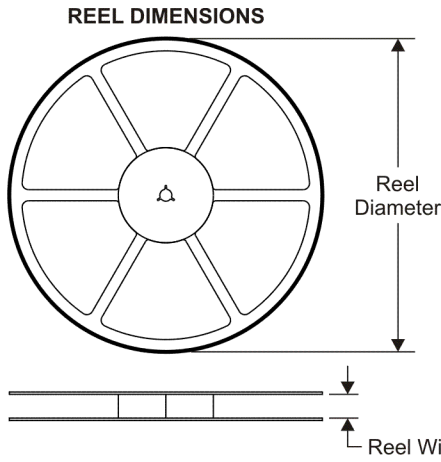

A0	Dimension designed to accommodate the component width
B0	Dimension designed to accommodate the component length
K0	Dimension designed to accommodate the component thickness
W	Overall width of the carrier tape
P1	Pitch between successive cavity centers

**QUADRANT ASSIGNMENTS FOR PIN 1 ORIENTATION IN TAPE**

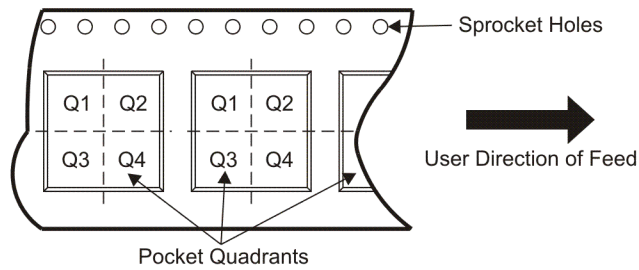

\*All dimensions are nominal

Device	Package Type	Package Drawing	Pins	SPQ	Reel Diameter (mm)	Reel Width W1 (mm)	A0 (mm)	B0 (mm)	K0 (mm)	P1 (mm)	W (mm)	Pin1 Quadrant
TPA302DR	SOIC	D	8	2500	330.0	12.4	6.4	5.2	2.1	8.0	12.0	Q1

**TAPE AND REEL BOX DIMENSIONS**



\*All dimensions are nominal

Device	Package Type	Package Drawing	Pins	SPQ	Length (mm)	Width (mm)	Height (mm)
TPA302DR	SOIC	D	8	2500	346.0	346.0	29.0

D (R-PDSO-G8)

PLASTIC SMALL OUTLINE

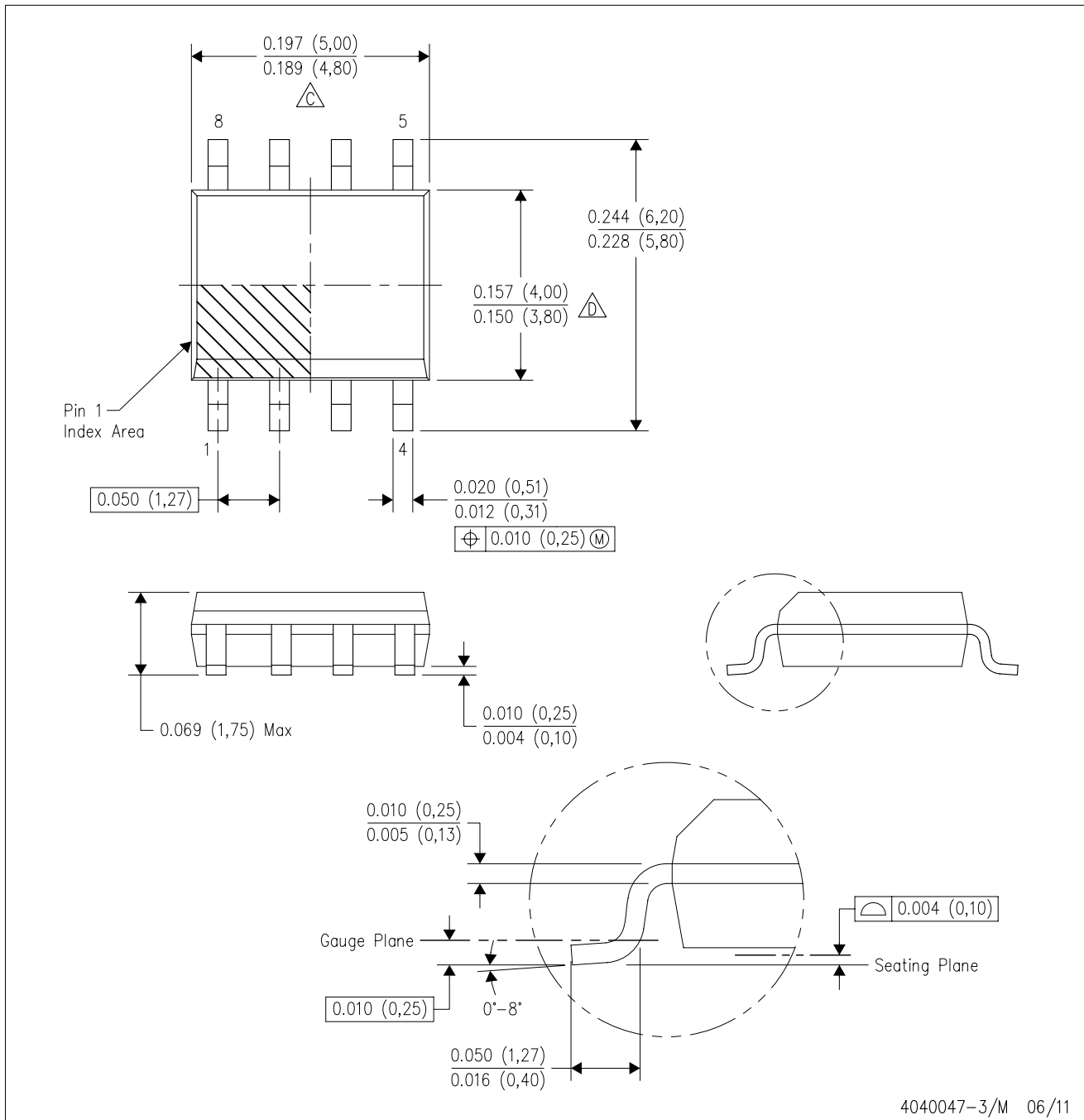

- NOTES:
- A. All linear dimensions are in inches (millimeters).
  - B. This drawing is subject to change without notice.
  - Body length does not include mold flash, protrusions, or gate burrs. Mold flash, protrusions, or gate burrs shall not exceed 0.006 (0,15) each side.
  - Body width does not include interlead flash. Interlead flash shall not exceed 0.017 (0,43) each side.
  - E. Reference JEDEC MS-012 variation AA.

D (R-PDSO-G8)

PLASTIC SMALL OUTLINE

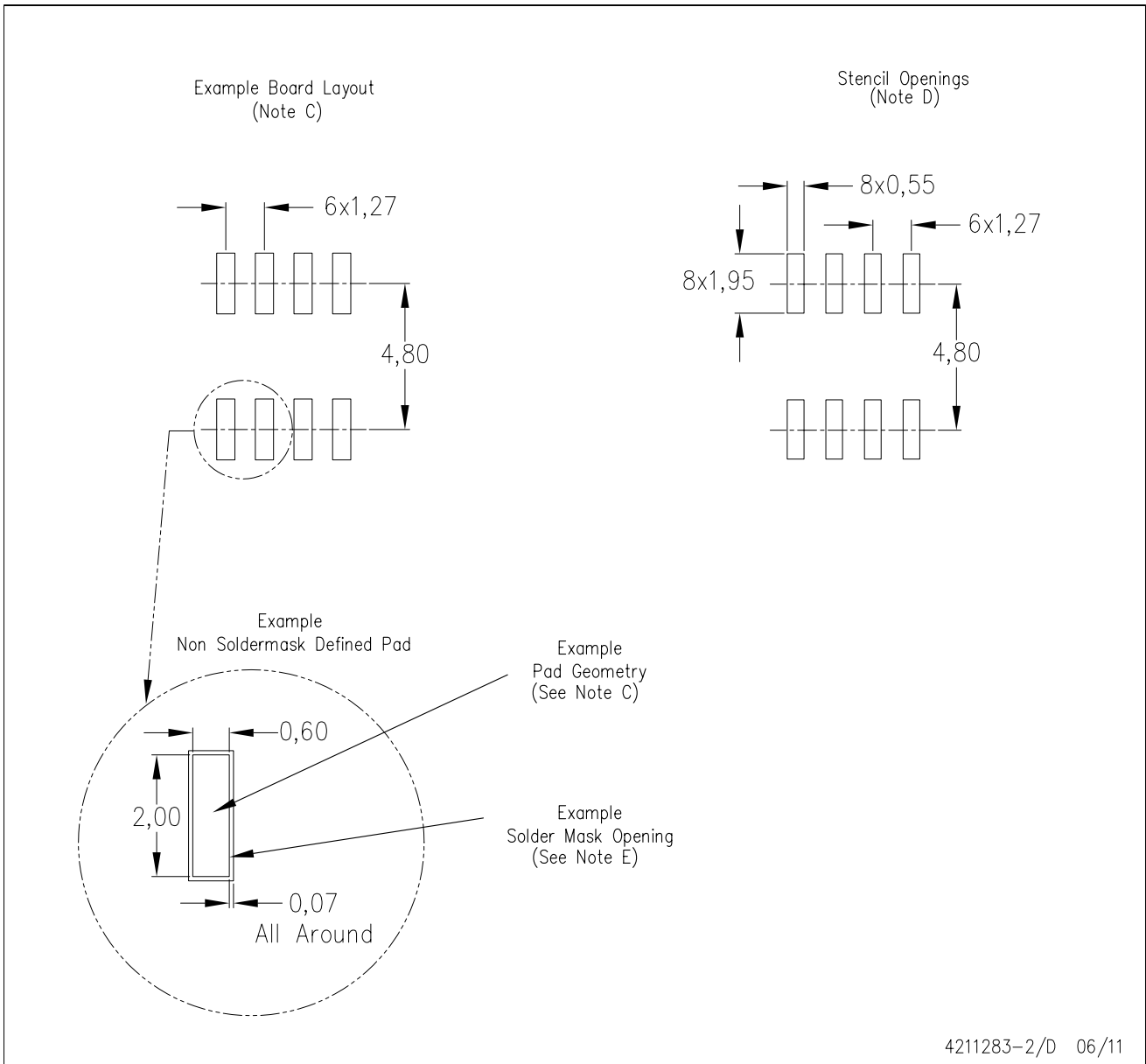

- NOTES:
- All linear dimensions are in millimeters.
  - This drawing is subject to change without notice.
  - Publication IPC-7351 is recommended for alternate designs.
  - Laser cutting apertures with trapezoidal walls and also rounding corners will offer better paste release. Customers should contact their board assembly site for stencil design recommendations. Refer to IPC-7525 for other stencil recommendations.
  - Customers should contact their board fabrication site for solder mask tolerances between and around signal pads.



## IMPORTANT NOTICE

Texas Instruments Incorporated and its subsidiaries (TI) reserve the right to make corrections, modifications, enhancements, improvements, and other changes to its products and services at any time and to discontinue any product or service without notice. Customers should obtain the latest relevant information before placing orders and should verify that such information is current and complete. All products are sold subject to TI's terms and conditions of sale supplied at the time of order acknowledgment.

TI warrants performance of its hardware products to the specifications applicable at the time of sale in accordance with TI's standard warranty. Testing and other quality control techniques are used to the extent TI deems necessary to support this warranty. Except where mandated by government requirements, testing of all parameters of each product is not necessarily performed.

TI assumes no liability for applications assistance or customer product design. Customers are responsible for their products and applications using TI components. To minimize the risks associated with customer products and applications, customers should provide adequate design and operating safeguards.

TI does not warrant or represent that any license, either express or implied, is granted under any TI patent right, copyright, mask work right, or other TI intellectual property right relating to any combination, machine, or process in which TI products or services are used. Information published by TI regarding third-party products or services does not constitute a license from TI to use such products or services or a warranty or endorsement thereof. Use of such information may require a license from a third party under the patents or other intellectual property of the third party, or a license from TI under the patents or other intellectual property of TI.

Reproduction of TI information in TI data books or data sheets is permissible only if reproduction is without alteration and is accompanied by all associated warranties, conditions, limitations, and notices. Reproduction of this information with alteration is an unfair and deceptive business practice. TI is not responsible or liable for such altered documentation. Information of third parties may be subject to additional restrictions.

Resale of TI products or services with statements different from or beyond the parameters stated by TI for that product or service voids all express and any implied warranties for the associated TI product or service and is an unfair and deceptive business practice. TI is not responsible or liable for any such statements.

TI products are not authorized for use in safety-critical applications (such as life support) where a failure of the TI product would reasonably be expected to cause severe personal injury or death, unless officers of the parties have executed an agreement specifically governing such use. Buyers represent that they have all necessary expertise in the safety and regulatory ramifications of their applications, and acknowledge and agree that they are solely responsible for all legal, regulatory and safety-related requirements concerning their products and any use of TI products in such safety-critical applications, notwithstanding any applications-related information or support that may be provided by TI. Further, Buyers must fully indemnify TI and its representatives against any damages arising out of the use of TI products in such safety-critical applications.

TI products are neither designed nor intended for use in military/aerospace applications or environments unless the TI products are specifically designated by TI as military-grade or "enhanced plastic." Only products designated by TI as military-grade meet military specifications. Buyers acknowledge and agree that any such use of TI products which TI has not designated as military-grade is solely at the Buyer's risk, and that they are solely responsible for compliance with all legal and regulatory requirements in connection with such use.

TI products are neither designed nor intended for use in automotive applications or environments unless the specific TI products are designated by TI as compliant with ISO/TS 16949 requirements. Buyers acknowledge and agree that, if they use any non-designated products in automotive applications, TI will not be responsible for any failure to meet such requirements.

Following are URLs where you can obtain information on other Texas Instruments products and application solutions:

### Products

Audio	<a href="http://www.ti.com/audio">www.ti.com/audio</a>
Amplifiers	<a href="http://amplifier.ti.com">amplifier.ti.com</a>
Data Converters	<a href="http://dataconverter.ti.com">dataconverter.ti.com</a>
DLP® Products	<a href="http://www.dlp.com">www.dlp.com</a>
DSP	<a href="http://dsp.ti.com">dsp.ti.com</a>
Clocks and Timers	<a href="http://www.ti.com/clocks">www.ti.com/clocks</a>
Interface	<a href="http://interface.ti.com">interface.ti.com</a>
Logic	<a href="http://logic.ti.com">logic.ti.com</a>
Power Mgmt	<a href="http://power.ti.com">power.ti.com</a>
Microcontrollers	<a href="http://microcontroller.ti.com">microcontroller.ti.com</a>
RFID	<a href="http://www.ti-rfid.com">www.ti-rfid.com</a>
RF/IF and ZigBee® Solutions	<a href="http://www.ti.com/lprf">www.ti.com/lprf</a>

### Applications

Communications and Telecom	<a href="http://www.ti.com/communications">www.ti.com/communications</a>
Computers and Peripherals	<a href="http://www.ti.com/computers">www.ti.com/computers</a>
Consumer Electronics	<a href="http://www.ti.com/consumer-apps">www.ti.com/consumer-apps</a>
Energy and Lighting	<a href="http://www.ti.com/energy">www.ti.com/energy</a>
Industrial	<a href="http://www.ti.com/industrial">www.ti.com/industrial</a>
Medical	<a href="http://www.ti.com/medical">www.ti.com/medical</a>
Security	<a href="http://www.ti.com/security">www.ti.com/security</a>
Space, Avionics and Defense	<a href="http://www.ti.com/space-avionics-defense">www.ti.com/space-avionics-defense</a>
Transportation and Automotive	<a href="http://www.ti.com/automotive">www.ti.com/automotive</a>
Video and Imaging	<a href="http://www.ti.com/video">www.ti.com/video</a>
Wireless	<a href="http://www.ti.com/wireless-apps">www.ti.com/wireless-apps</a>

TI E2E Community Home Page

[e2e.ti.com](http://e2e.ti.com)

Mailing Address: Texas Instruments, Post Office Box 655303, Dallas, Texas 75265  
Copyright © 2011, Texas Instruments Incorporated

[www.BDTIC.com/TI](http://www.BDTIC.com/TI)