



POWER AND BATTERY MANAGEMENT IC FOR Li-ION POWERED SYSTEMS

FEATURES

- Linear Charger Management for Single Li-Ion or Li-Polymer Cells
- Dual Input Ports for Charging From USB or From Wall Plug, Handles 100-mA / 500-mA USB Requirements
- Charge Current Programmable via External Resistor
- 1-A, 95% Efficient Step-Down Converter for I/O and Peripheral Components (VMAIN)
- 400-mA, 90% Efficient Step-Down Converter for Processor Core (VCORE)
- 2x 200-mA LDOs for I/O and Peripheral Components, LDO Enable via Bus
- Serial Interface Compatible With I²C, Supports 100-kHz, 400-kHz Operation at 1.8 V
- LOW_PWR Pin to Lower or Disable Processor Core Supply Voltage in Deep Sleep Mode
- 70- μ A Quiescent Current
- 1% Reference Voltage
- Thermal Shutdown Protection

APPLICATIONS

- All Single Li-Ion Cell-Operated Products Requiring Multiple Supplies Including:
 - PDA
 - Cellular/Smart Phone
 - Internet Audio Player
 - Digital Still Camera
- Digital Radio Player
- Split Supply DSP and μ P Solutions
- Applications Based on OMAP1710

DESCRIPTION

The TPS65013 is an integrated power and battery management IC for applications powered by one Li-ion or Li-polymer cell and which require multiple power rails. The TPS65013 provides two highly efficient, step-down converters targeted at providing the core voltage and peripheral, I/O rails in a processor-based system. Both step-down converters enter a low-power mode at light load for maximum efficiency across the widest possible range of load currents. The LOW_PWR pin allows the core converter to lower its output voltage when the application processor goes into deep sleep. The TPS65013 also integrates two 200-mA LDO voltage regulators, which are enabled via the serial interface. Each LDO operates with an input voltage range between 1.8 V and 6.5 V, allowing them to be supplied from one of the step-down converters or directly from the battery.

The TPS65013 also has a highly integrated and flexible Li-ion linear charger and system power management. It offers integrated USB-port and ac-adaptor supply management with autonomous power-source selection, power FET and current sensor, high accuracy current and voltage regulation, charge status, and charge termination.

The TPS65013 charger automatically selects the USB port or the ac adapter as the power source for the system. In the USB configuration, the host can increase the charge current from the default value of maximum 100 mA to 500 mA via the interface. In the ac-adaptor configuration, an external resistor sets the maximum value of charge current.

The battery is charged in three phases: conditioning, constant current, and constant voltage. Charge is normally terminated based on minimum current. An internal charge timer provides a safety backup for charge termination. The TPS65013 automatically restarts the charge if the battery voltage falls below an internal threshold. The charger automatically enters sleep mode when both supplies are removed.



Please be aware that an important notice concerning availability, standard warranty, and use in critical applications of Texas Instruments semiconductor products and disclaimers thereto appears at the end of this data sheet.

I²C is a trademark of Phillips.

PowerPAD is a trademark of Texas Instruments.



These devices have limited built-in ESD protection. The leads should be shorted together or the device placed in conductive foam during storage or handling to prevent electrostatic damage to the MOS gates.

The serial interface can be used for dynamic voltage scaling, for collecting information on and controlling the battery charger status, for optionally controlling 2 LED driver outputs, a vibrator driver, masking interrupts, or for disabling/enabling and setting the LDO output voltages. The interface is compatible with the fast/standard mode I²C™ specification allowing transfers at up to 400 kHz.

ORDERING INFORMATION

T _A	PACKAGE	PART NUMBER ⁽¹⁾
-40°C to 85°C	7 mm × 7 mm, 48-pin QFN	TPS65013RGZ

- (1) The RGZ package is available in tape and reel. Add R suffix (TPS65013RGZR) to order quantities of 2500 parts per reel. Add T suffix (TPS65013RGZT) to order quantities of 250 parts per reel.

ABSOLUTE MAXIMUM RATINGS

over operating free-air temperature range unless otherwise noted⁽¹⁾

	UNIT
Input voltage on VAC pin with respect to AGND	20 V
Input voltage range on all other pins except AGND/PGND pins with respect to AGND	-0.3 V to 7 V
HBM and CDM capabilities at pins VIB, \overline{PG} , and LED2	1 kV
Current at AC, VBAT, VINMAIN, L1, PGND1	1800 mA
Peak current at all other pins	1000 mA
Continuous power dissipation	See Dissipation Rating Table
Operating free-air temperature, T _A	-40°C to 85°C
Maximum junction temperature, T _J	125°C
Storage temperature, T _{stg}	-65°C to 150°C
Lead temperature 1,6 mm (1/16 inch) from case for 10 seconds	260°C

- (1) Stresses beyond those listed under *absolute maximum ratings* may cause permanent damage to the device. These are stress ratings only, and functional operation of the device at these or any other conditions beyond those indicated under *recommended operating conditions* is not implied. Exposure to absolute-maximum-rated conditions for extended periods may affect device reliability.

PACKAGE DISSIPATION RATINGS⁽¹⁾

AMBIENT TEMPERATURE	MAX POWER DISSIPATION FOR T _j = 125°C ⁽²⁾	DERATING FACTOR ABOVE T _A = 55°C
25°C	3 W	30 mW/°C
55°C	2.1 W	

- (1) The TPS65013 is housed in a 48-pin QFN package with exposed leadframe on the underside. This 7 mm × 7 mm package exhibits a thermal impedance (junction-to-ambient) of 33 K/W when mounted on a JEDEC high-k board.
- (2) Consideration needs to be given to the maximum charge current when the assembled application board exhibits a thermal impedance which differs significantly from the JEDEC high-k board.

RECOMMENDED OPERATING CONDITIONS

		MIN	NOM	MAX	UNIT
$V_{(AC)}$	Supply voltage from ac adapter	4.5		5.5	V
$V_{(USB)}$	Supply voltage from USB	4.4		5.25	V
$V_{(BAT)}$	Voltage at charger output/battery	2.5		4.2	V
$V_{I(MAIN)}, V_{I(CORE)}, V_{CC}$	Input voltage range step-down converters	2.5		6.0	V
$V_{I(LDO1)}, V_{I(LDO2)}$	Input voltage range for LDOs	1.8		6.5	V
T_A	Operating ambient temperature	-40		85	°C
T_J	Operating junction temperature	-40		125	°C
$R_{(CC)}$	Resistor from $V_{I(main)}, V_{I(core)}$ to V_{CC} used for filtering, $C_{I(VCC)} = 1 \mu F$		10	100	Ω

ELECTRICAL CHARACTERISTICS

$V_{I(MAIN)} = V_{I(CORE)} = V_{CC} = V_{I(LDO1)} = V_{I(LDO2)} = 3.6 V$, $T_A = -40^\circ C$ to $85^\circ C$, typical values are at $T_A = 25^\circ C$ battery charger specifications are valid in the range $0^\circ C < T_A < 85^\circ C$ unless otherwise noted

PARAMETER	TEST CONDITIONS	MIN	TYP	MAX	UNIT	
Control Signals: LOW_PWR, SCLK, SDAT (Input)						
V_{IH}	High-level input voltage	$I_{IH} = 20 \mu A^{(1)}$	1.2	V_{CC}	V	
V_{IL}	Low-level input voltage	$I_{IL} = 10 \mu A$	0	0.4	V	
I_{IB}	Input bias current		0.01	1.0	μA	
Control Signals: PB_ONOFF, HOT_RESET, BATT_COVER						
V_{IH}	High-level input voltage	$I_{IH} = 20 \mu A^{(1)}$	$0.8 V_{CC}$	6	V	
V_{IL}	Low-level input voltage	$I_{IL} = 10 \mu A$	0	0.4	V	
$R_{(pb_onoff)}$	Pulldown resistor at PB_ONOFF		1000		k Ω	
$R_{(hot_reset)}$	Pullup resistor at HOT_RESET, connected to VCC		1000		k Ω	
$R_{(batt_cover)}$	Pulldown resistor at BATT_COVER		2000		k Ω	
$t_{(glitch)}$	De-glitch time at all 3 pins		38	56	77	ms
$t_{(batt_cover)}$	Delay after $t_{(glitch)}$ (PWRFAIL goes low) before supplies are disabled when BATT_COVER goes low.		1.68	2.4	3.2	ms
CONTROL SIGNALS: MPU_RESET, PWRFAIL, RESPWRON, INT, SDAT (output)						
V_{OH}	High-level output voltage			6	V	
V_{OL}	Low-level output voltage	$I_{IL} = 10 mA$	0	0.3	V	
$t_{d(mpu_nreset)}$	Duration of low pulse at MPU_RESET		100		μs	
$t_{d(nrespwron)}$	Duration of low pulse at RESPWRON after VMAIN is in regulation	TPOR = 0	80	100	120	ms
		TPOR = 1	800	1000	1200	
$t_{d(uvlo)}$	Time between UVLO going active (PWRFAIL going low) and supplies being disabled		1.68	2.4	3.2	ms
$t_{d(overtemp)}$	Time between chip overtemperature condition being recognized (PWRFAIL going low) and supplies being disabled		1.68	2.4	3.2	ms
SUPPLY PIN: VCC						
$I_{(Q)}$	Operating quiescent current	$V_I = 3.6 V$, current into Main + Core + V_{CC}		70	μA	
$I_{(O(SD))}$	Shutdown supply current	$V_I = 3.6 V$, BATT_COVER = GND, current into Main + Core + V_{CC}		15	25	μA
VMAIN STEP-DOWN CONVERTER						
V_I	Input voltage range		2.5	6.0	V	
I_O	Maximum output current		1000		mA	
$I_{O(SD)}$	Shutdown supply current	BATT_COVER = GND		0.1	1	μA
$r_{DS(on)}$	P-channel MOSFET on-resistance	$V_{I(MAIN)} = V_{GS} = 3.6 V$		110	210	m Ω

(1) If the input voltage is higher than V_{CC} , an additional input current, limited by an internal 10-k Ω resistor, flows.

ELECTRICAL CHARACTERISTICS (continued)

$V_{I(MAIN)} = V_{I(CORE)} = V_{CC} = V_{I(LDO1)} = V_{I(LDO2)} = 3.6\text{ V}$, $T_A = -40^\circ\text{C}$ to 85°C , typical values are at $T_A = 25^\circ\text{C}$ battery charger specifications are valid in the range $0^\circ\text{C} < T_A < 85^\circ\text{C}$ unless otherwise noted

PARAMETER		TEST CONDITIONS	MIN	TYP	MAX	UNIT
$I_{ikg(p)}$	P-channel leakage current	$V_{(DS)} = 6\text{ V}$			1	μA
$r_{DS(on)}$	N-channel MOSFET on-resistance	$V_{I(MAIN)} = V_{GS} = 3.6\text{ V}$		110	200	$\text{m}\Omega$
$I_{ikg(N)}$	N-channel leakage current	$V_{(DS)} = 6\text{ V}$			1	μA
I_L	P-channel current limit	$2.5\text{ V} < V_{I(MAIN)} < 6\text{ V}$	1.4	1.75	2.1	A
f_s	Oscillator frequency		1	1.25	1.5	MHz
$V_{O(MAIN)}$	Fixed output voltage	1.8 V	$V_{I(MAIN)} = 2.5\text{ V}$ to 6 V ; $I_O = 0\text{ mA}$		0%	3%
			$V_{I(MAIN)} = 2.5\text{ V}$ to 6 V ; $0\text{ mA} \leq I_O \leq 1000\text{ mA}$		3%	3%
		2.75 V	$V_{I(MAIN)} = 2.95\text{ V}$ to 6 V ; $I_O = 0\text{ mA}$		0%	3%
			$V_{I(MAIN)} = 2.95\text{ V}$ to 6 V ; $0\text{ mA} \leq I_O \leq 1000\text{ mA}$		3%	3%
		3.0 V	$V_{I(MAIN)} = 3.2\text{ V}$ to 6 V ; $I_O = 0\text{ mA}$		0%	3%
			$V_{I(MAIN)} = 3.2\text{ V}$ to 6 V ; $0\text{ mA} \leq I_O \leq 1000\text{ mA}$		3%	3%
		3.3 V	$V_{I(MAIN)} = 3.5\text{ V}$ to 6 V ; $I_O = 0\text{ mA}$		0%	3%
			$V_{I(MAIN)} = 3.5\text{ V}$ to 6 V ; $0\text{ mA} \leq I_O \leq 1000\text{ mA}$		3%	3%
Line regulation		$V_{I(MAIN)} = V_{O(MAIN)} + 0.5\text{ V}$ (min. 2.5 V) to 6 V , $I_O = 10\text{ mA}$		0.5		%/V
Load regulation		$I_O = 10\text{ mA}$ to 1000 mA		0.12		%/A
$R_{(VMMAIN)}$	VMAIN discharge resistance			400		Ω
VCORE STEP-DOWN CONVERTER						
V_I	Input voltage range		2.5		6.0	V
I_O	Maximum output current		400			mA
$I_{O(SD)}$	Shutdown supply current	BATT_COVER = GND		0.1	1	μA
$r_{DS(on)}$	P-channel MOSFET on-resistance	$V_{I(CORE)} = V_{GS} = 3.6\text{ V}$		275	530	$\text{m}\Omega$
$I_{ikg(p)}$	P-channel leakage current	$V_{DS} = 6\text{ V}$		0.1	1	μA
$r_{DS(on)}$	N-channel MOSFET on-resistance	$V_{I(CORE)} = V_{GS} = 3.6\text{ V}$		275	500	$\text{m}\Omega$
$I_{ikg(N)}$	N-channel leakage current	$V_{DS} = 6\text{ V}$		0.1	1	μA
I_L	P-channel current limit	$2.5\text{ V} < V_{I(CORE)} < 6\text{ V}$	600	700	900	mA
f_s	Oscillator frequency		1	1.25	1.5	MHz

ELECTRICAL CHARACTERISTICS (continued)

$V_{I(MAIN)} = V_{I(CORE)} = V_{CC} = V_{I(LDO1)} = V_{I(LDO2)} = 3.6\text{ V}$, $T_A = -40^\circ\text{C}$ to 85°C , typical values are at $T_A = 25^\circ\text{C}$ battery charger specifications are valid in the range $0^\circ\text{C} < T_A < 85^\circ\text{C}$ unless otherwise noted

PARAMETER		TEST CONDITIONS	MIN	TYP	MAX	UNIT
$V_{O(CORE)}$	Fixed output voltage	0.85 V $V_{I(CORE)} = 2.5\text{ V to }6\text{ V};$ $I_O = 0\text{ mA}, C_O = 22\text{ }\mu\text{F}$	0%		3%	
			3%		3%	
		1.05 V $V_{I(CORE)} = 2.5\text{ V to }6\text{ V};$ $I_O = 0\text{ mA}, C_O = 22\text{ }\mu\text{F}$	0%		3%	
			3%		3%	
		1.1 V $V_{I(CORE)} = 2.5\text{ V to }6\text{ V};$ $I_O = 0\text{ mA}, C_O = 22\text{ }\mu\text{F}$	0%		3%	
			3%		3%	
		1.2 V $V_{I(CORE)} = 2.5\text{ V to }6\text{ V}; I_O = 0\text{ mA}$ $V_{I(CORE)} = 2.5\text{ V to }6\text{ V}; 0\text{ mA} \leq I_O \leq 400\text{ mA}$	0%		3%	
			3%		3%	
		1.3 V $V_{I(CORE)} = 2.5\text{ V to }6\text{ V}; I_O = 0\text{ mA}$ $V_{I(CORE)} = 2.5\text{ V to }6\text{ V};$ $0\text{ mA} \leq I_O \leq 400\text{ mA}$	0%		3%	
			3%		3%	
		1.4 V $V_{I(CORE)} = 2.5\text{ V to }6\text{ V}; I_O = 0\text{ mA}$ $V_{I(CORE)} = 2.5\text{ V to }6\text{ V};$ $0\text{ mA} \leq I_O \leq 400\text{ mA}$	0%		3%	
			3%		3%	
		1.5 V $V_{I(CORE)} = 2.5\text{ V to }6\text{ V}; I_O = 0\text{ mA}$ $V_{I(CORE)} = 2.5\text{ V to }6\text{ V};$ $0\text{ mA} \leq I_O \leq 400\text{ mA}$	0%		3%	
			3%		3%	
		1.6 V $V_{I(CORE)} = 2.5\text{ V to }6\text{ V}; I_O = 0\text{ mA}$ $V_{I(CORE)} = 2.5\text{ V to }6\text{ V};$ $0\text{ mA} \leq I_O \leq 400\text{ mA}$	0%		3%	
			3%		3%	
Line regulation		$V_{I(CORE)} = V_{O(MAIN)} + 0.5\text{ V}$ (min. 2.5 V) to 6 V, $I_O = 10\text{ mA}$		1		%/V
Load regulation		$I_O = 10\text{ mA to }400\text{ mA}$		0.002		%/mA
$R_{V(CORE)}$	VCORE discharge resistance			400		Ω
VLDO1 and VLDO2 LOW-DROPOUT REGULATORS						
V_I	Input voltage range	LD01	1.8		6.5	V
		LD02	1.8		V_{CC}	
V_O	LDO1 output voltage range		0.9		VINLDO1	V
V_{ref}	Reference voltage		485	500	515	mV
V_O	LDO2 output voltage range		1.8		3.3	V
I_O	Maximum output current	Full-power mode	200			mA
		Low-power mode	30			
$I_{(SC)}$	LDO1 & LDO2 short-circuit current limit	VLDO1 = GND, VLDO2 = GND			650	mA
	Dropout voltage	$I_O = 200\text{ mA}, V_{INLDO1,2} = 1.8\text{ V}$			300	mV
	Total accuracy				$\pm 3\%$	
	Line regulation	VINLDO1,2 = VLDO1,2 + 0.5 V (min. 2.5 V) to 6.5 V, $I_O = 10\text{ mA}$		0.75		%/V
	Load regulation	$I_O = 10\text{ mA to }200\text{ mA}$		0.011		%/mA
	Regulation time	Load change from 10% to 90%			0.1	ms
		Low-power mode			0.1	
$I_{(QFP)}$	LDO quiescent current (each LDO)	Full-power mode		16	30	μA
$I_{(QLPM)}$	LDO quiescent current (each LDO)	Low-power mode		12	18	μA
$I_{(SD)}$	LDO shutdown current (each LDO)			0.1	1	μA
$I_{(kg(FB))}$	Leakage current feedback			0.01	0.1	μA

ELECTRICAL CHARACTERISTICS

Battery Charger, $V_{O(REG)} + V_{(DO-MAX)} \leq V_{(CHG)} = V_{(AC)}$ or $V_{(USB)}$, $I_{(TERM)} < I_O \leq 1 \text{ A}$, $0^\circ\text{C} < T_A < 85^\circ\text{C}$

PARAMETER		TEST CONDITIONS	MIN	TYP	MAX	UNIT
$V_{(AC)}$	Input voltage range		4.5		5.5	V
$V_{(USB)}$	Input voltage range		4.35		5.25	V
$I_{CC(VCHG)}$	Supply current	$V_{(CHG)} > V_{(CHG)min}$		1.2	2	mA
$I_{CC(SLP)}$	Sleep current	Sum of currents into VBAT pin, $V_{(CHG)} < V_{(SLP-ENTRY)}$, $0^\circ\text{C} \leq T_J \leq 85^\circ\text{C}$		2	5	μA
$I_{CC(STBY)}$	Standby current	Current into USB pin			45	μA
		Current into AC pin		200	400	
VOLTAGE REGULATOR						
V_O	Output voltage	$V_{(CHG)min} \geq 4.5 \text{ V}$	4.15	4.20	4.25	V
V_{DO}	Dropout voltage ($V_{(AC)} - V_{BAT}$)	$V_{O(REG)} + V_{(DO-MAX)} \leq V_{(CHG)}$, $I_{O(OUT)} = 1 \text{ A}$		500	800	mV
	Dropout voltage ($V_{(USB)} - V_{BAT}$)	$V_{O(REG)} + V_{(DO-MAX)} \leq V_{(CHG)}$, $I_{O(OUT)} = 0.5 \text{ A}$		300	500	
	Dropout voltage ($V_{(USB)} - V_{BAT}$)	$V_{O(REG)} + V_{(DO-MAX)} \leq V_{(CHG)}$, $I_{O(OUT)} = 0.1 \text{ A}$		100	150	
CURRENT REGULATION						
$I_{O(AC)}$	Output current range for ac operation ⁽¹⁾	$V_{CHG} \geq 4.5 \text{ V}$, $V_{I(OUT)} > V_{(LOWV)}$, $V_{(AC)} - V_{I(BAT)} > V_{(DO-MAX)}$	100		1000	mA
$V_{(SET)}$	Output current set voltage for ac operation at ISET pin. 100% output current I ² C register CHGCONFIG<4:3> = 11	$V_{min} \geq 4.5 \text{ V}$, $V_{I(BAT)} > V_{(LOWV)}$, $V_{(AC)} - V_{I(BAT)} > V_{(DO-MAX)}$	2.45	2.50	2.55	V
	75% output current I ² C register CHGCONFIG<4:3> = 10		1.83	1.91	1.99	
	50% output current I ² C register CHGCONFIG<4:3> = 01		1.23	1.31	1.39	
	32% output current I ² C register CHGCONFIG<4:3> = 00		0.76	0.81	0.86	
KSET	Output current set factor for ac operation	$100 \text{ mA} < I_O < 1000 \text{ mA}$	310	330	350	
		$10 \text{ mA} < I_O < 100 \text{ mA}$	300	340	380	
$I_{O(USB)}$	Output current range for USB operation	$V_{(CHG)min} \geq 4.35 \text{ V}$, $V_{I(BAT)} > V_{(LOWV)}$, $V_{(USB)} - V_{I(BAT)} > V_{(DO-MAX)}$, I ² C register CHGCONFIG<2> = 0	80		100	mA
		$V_{(CHG)min} \geq 4.5 \text{ V}$, $V_{I(BAT)} > V_{(LOWV)}$, $V_{(USB)} - V_{I(BAT)} > V_{(DO-MAX)}$, I ² C register CHGCONFIG<2> = 1	400		500	
$R_{(ISET)}$	Resistor range at ISET pin		825		8250	Ω
PRECHARGE CURRENT REGULATION, SHORT-CIRCUIT CURRENT, AND BATTERY DETECTION CURRENT						
$V_{(LOWV)}$	Precharge to fast-charge transition threshold, voltage on VBAT pin.	$V_{(CHG)min} \geq 4.5 \text{ V}$	2.8	3.0	3.2	V
	De-glitch time	$V_{(CHG)min} \geq 4.5 \text{ V}$, $V_{I(OUT)}$ decreasing below threshold; 100-ns fall time, 10-mV overdrive	8.8	23	60	ms
$I_{(PRECHG)}$	Precharge current ⁽²⁾	$0 \leq V_{I(OUT)} < V_{(LOWV)}$, $t < t_{(PRECHG)}$	10		100	mA
$I_{(DETECT)}$	Battery detection current			200		μA
$V_{(SET-PRECHG)}$	Voltage at ISET pin	$0 \leq V_{I(OUT)} < V_{(LOWV)}$, $t < t_{(PRECHG)}$	240	255	270	mV
CHARGE TAPER AND TERMINATION DETECTION						
$I_{(TAPER)}$	Taper current detect range ⁽³⁾	$V_{I(OUT)} > V_{(RCH)}$, $t < t_{(TAPER)}$	10		100	mA

$$(1) \quad I_{O(AC)} + \frac{KSET \times V_{(SET)}}{R_{(ISET)}}$$

$$(2) \quad I_{(PRECHG)} + \frac{KSET \times V_{(SET_PRECHG)}}{R_{(ISET)}}$$

$$(3) \quad I_{(TAPER)} + \frac{KSET \times V_{(SET_TAPER)}}{R_{(ISET)}}$$

ELECTRICAL CHARACTERISTICS (continued)

Battery Charger, $V_{O(REG)} + V_{(DO-MAX)} \leq V_{(CHG)} = V_{(AC)}$ or $V_{(USB)}$, $I_{(TERM)} < I_O \leq 1 \text{ A}$, $0^\circ\text{C} < T_A < 85^\circ\text{C}$

PARAMETER	TEST CONDITIONS	MIN	TYP	MAX	UNIT	
$V_{(SET_TAPER)}$	Voltage at ISET pin for charge TAPER detection	$V_{I(OUT)} > V_{(RCH)}$, $t < t_{(TAPER)}$	235	250	265	mV
$V_{(SET_TERM)}$	Voltage at ISET pin for charger termination detection ⁽⁴⁾	$V_{I(OUT)} > V_{(RCH)}$	11	18	25	mV
	De-glitch time for $I_{(TAPER)}$	$V_{(CHG),min} \geq 4.5 \text{ V}$, charging current increasing or decreasing above and below; 100-ns fall time, 10-mV overdrive	8.8	23	60	ms
	De-glitch time for $I_{(TERM)}$	$V_{(CHG),min} \geq 4.5 \text{ V}$, charging current decreasing below; 100-ns fall time, 10-mV overdrive	8.8	23	60	ms
TEMPERATURE COMPARATOR						
$V_{(LTF)}$	Low (cold) temperature threshold		2.475	2.50	2.525	V
$V_{(HTF)}$	High (hot) temperature threshold		0.485	0.5	0.515	V
$I_{(TS)}$	TS current source		95	102	110	μA
	De-glitch time for temperature fault		8.8	23	60	ms
BATTERY RECHARGE THRESHOLD						
$V_{(RCH)}$	Recharge threshold	$V_{(CHG),min} \geq 4.5 \text{ V}$	$V_{O(REG)} - 0.115$	$V_{O(REG)} - 0.1$	$V_{O(REG)} - 0.085$	V
	De-glitch time	$V_{(CHG),min} \geq 4.5 \text{ V}$, $V_{I(OUT)}$ decreasing below threshold; 100-ns fall time, 10-mV overdrive	8.8	23	60	ms
TIMERS						
$t_{(PRECHG)}$	Precharge timer	$V_{(CHG),min} \geq 4.5 \text{ V}$	1500	1800	2160	s
$t_{(TAPER)}$	Taper timer	$V_{(CHG),min} \geq 4.5 \text{ V}$	1500	1800	2160	s
$t_{(CHG)}$	Charge timer	$V_{(CHG),min} \geq 4.5 \text{ V}$	15000	18000	21600	s
SLEEP AND STANDBY						
$V_{(SLP_ENTRY)}$	Sleep-mode entry threshold, \overline{PG} output = high	$2.3 \text{ V} \leq V_{I(OUT)} \leq V_{O(REG)}$			$V_{(CHG)} \leq V_{I(OUT)} + 150 \text{ mV}$	V
$V_{(SLP_EXIT)}$	Sleep-mode exit threshold, \overline{PG} output = low	$2.3 \text{ V} \leq V_{I(OUT)} \leq V_{O(REG)}$			$V_{(CHG)} \geq V_{I(OUT)} + 190 \text{ mV}$	V
	De-glitch time for sleep mode entry and exit	AC or USB decreasing below threshold; 100-ns fall time, 10-mV overdrive	8.8	23	60	ms
$t_{(USB_DEL)}$	Delay between valid USB voltage being applied and start of charging process from USB			5		ms
CHARGER POWER-ON-RESET, UVLO, AND $V_{(IN)}$ RAMP RATE						
$V_{(CHGUVLO)}$	Charger undervoltage lockout	$V_{(CHG)}$ decreasing	2.27	2.5	2.75	V
	Hysteresis			27		mV
$V_{(CHGOVLO)}$	Charger overvoltage lockout	$V_{(AC)}$ increasing			6.6	V
	Hysteresis				0.5	V
CHARGER OVERTEMPERATURE SUSPEND						
$T_{(suspend)}$	Temperature at which charger suspends operation			145		$^\circ\text{C}$
$T_{(hyst)}$	Hysteresis of suspend threshold			20		$^\circ\text{C}$
LOGIC SIGNALS DEFMAIN, DEFCORE, PS_SEQ, IFLSB						
V_{IH}	High-level input voltage	$I_{IH} = 20 \mu\text{A}$	$V_{CC} - 0.5$		V_{CC}	V
V_{IL}	Low-level input voltage	$I_{IL} = 10 \mu\text{A}$	0		0.4	V
I_{IB}	Input bias current			0.01	1.0	μA
LOGIC SIGNALS GPIO1-4						

$$(4) \quad I_{(TERM)} + \frac{KSET \times V_{(SET_TERM)}}{R_{(ISET)}}$$

ELECTRICAL CHARACTERISTICS (continued)Battery Charger, $V_{O(REG)} + V_{(DO-MAX)} \leq V_{(CHG)} = V_{(AC)}$ or $V_{(USB)}$, $I_{(TERM)} < I_O \leq 1 \text{ A}$, $0^\circ\text{C} < T_A < 85^\circ\text{C}$

PARAMETER		TEST CONDITIONS	MIN	TYP	MAX	UNIT
V_{OL}	Low-level output voltage	$I_{OL} = 1 \text{ mA}$, configured as an open-drain output			0.3	V
V_{OH}	High-level output voltage	Configured as an open-drain output			6	V
V_{IL}	Low-level input voltage		0		0.4	V
V_{IH}	High-level input voltage		1.2		$V_{CC}^{(5)}$	V
I_I	Input leakage current				1	μA
$r_{DS(on)}$	Internal NMOS	$V_{OL} = 0.3 \text{ V}$		150		Ω
LOGIC SIGNALS \overline{PG}, LED2						
V_{OL}	Low-level output voltage	$I_{OL} = 20 \text{ mA}$			0.5	V
V_{OH}	High-level output voltage				6	V
VIBRATOR DRIVER VIB						
V_{OL}	Low-level output voltage	$I_{OL} = 100 \text{ mA}$		0.3	0.5	V
V_{OH}	High-level output voltage				6	V
THERMAL SHUTDOWN						
$T_{(SD)}$	Thermal shutdown	Increasing junction temperature		160		$^\circ\text{C}$
UNDERVOLTAGE LOCKOUT						
$V_{(UVLO)}$	Undervoltage lockout threshold. The default value for UVLO is 2.75 V	$V_{(UVLO)} 2.5 \text{ V}$	Filter resistor = 10R in series with V_{CC} , V_{CC} decreasing	-3%	3%	
		$V_{(UVLO)} 2.75 \text{ V}$		-3%	3%	
		$V_{(UVLO)} 3.0 \text{ V}$		-3%	3%	
		$V_{(UVLO)} 3.25 \text{ V}$		-3%	3%	
$V_{(UVLO_HYST)}$	UVLO comparator hysteresis	V_{CC} rising	350	400	450	mV
POWER GOOD						
		VMAIN, VCORE, VLDO1, VLDO2 decreasing	-12%	-10%	-8%	
		VMAIN, VCORE, VLDO1, VLDO2 increasing	-7%	-5%	-3%	

(5) If the input voltage is higher than V_{CC} an additional current, limited by an internal 10-k Ω resistor, flows.

SERIAL INTERFACE TIMING REQUIREMENTS

	MIN	MAX	UNIT
Clock frequency, f_{MAX}		400	kHz
Clock high time, $t_{WH(HIGH)}$	600		ns
Clock low time, $t_{WL(LOW)}$	1300		ns
DATA and CLK rise time, t_R		300	ns
DATA and CLK fall time, t_F		300	ns
Hold time (repeated) START condition (after this period the first clock pulse is generated), $t_{h(STA)}$	600		ns
Setup time for repeated START condition, $t_{h(DATA)}$	600		ns
Data input hold time, $t_{h(DATA)}$	0		ns
Data input setup time, $t_{su(DATA)}$	100		ns
STOP condition setup time, $t_{su(STO)}$	600		ns
Bus free time, $t_{(BUF)}$	1300		ns

PIN ASSIGNMENTS

RGZ PACKAGE (TOP VIEW)

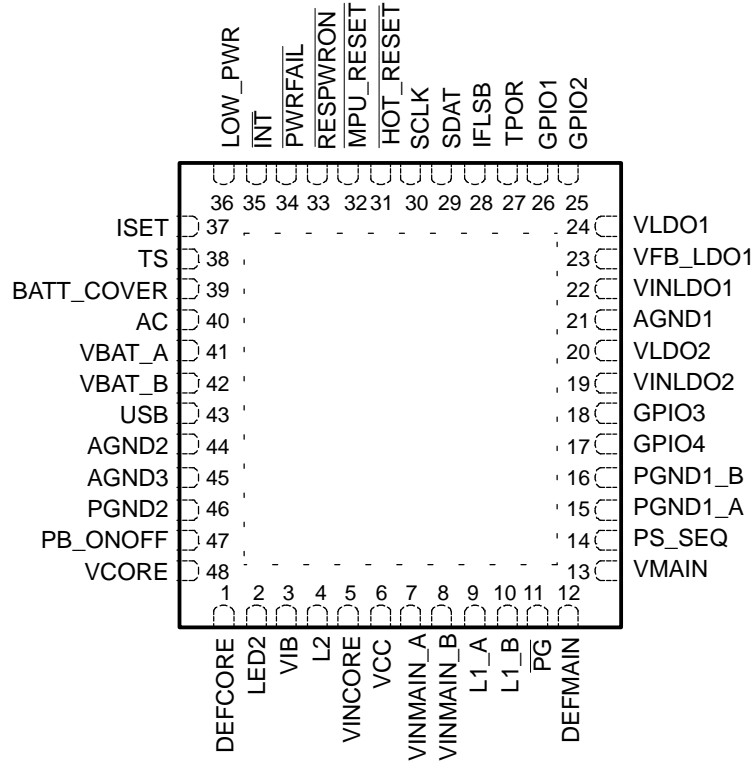

NC – No internal connection

PIN ASSIGNMENTS (continued)**Terminal Functions**

TERMINAL NAME	NO.	I/O	DESCRIPTION
CHARGER SECTION			
AC	40	I	Charger input voltage from ac adapter. The AC pin can be left open or can be connected to ground if the charger is not used.
USB	43	I	Charger input voltage from USB port. The USB pin can be left open or can be connected to ground if the charger is not used.
ISET	37	I	External charge current setting resistor connection for use with ac adapter
VBAT_A	41	I	Sense input for the battery voltage. Connect directly with the battery.
VBAT_B	42	O	Power output of the battery charger. Connect directly with the battery.
TS	38	I	Battery temperature sense input
$\overline{\text{PG}}$	11	O	Indicates when a valid power supply is present for the charger (open drain)
AGND2	44		Analog ground connection. All analog ground pins are connected internally on the chip.
PowerPAD™	-		Connect the PowerPAD to GND
SWITCHING REGULATOR SECTION			
AGND3	45		Analog ground connection. All analog ground pins are connected internally on the chip.
VINMAIN_A, VINMAIN_B	7,8	I	Input voltage for VMAIN step-down converter. This must be connected to the same voltage supply as VINCORE and VCC.
L1_A, L1_B	9,10		Switch pin of VMAIN converter. The VMAIN inductor is connected here.
VMAIN	13	I	VMAIN feedback voltage sense input, connect directly to VMAIN
VCC	6	I	Power supply for digital and analog circuitry of MAIN and CORE dc-dc converters. This must be connected to the same voltage supply as VINCORE and VINMAIN. Also supplies serial interface block
PGND1_A, PGND1_B	15,16		Power ground for VMAIN converter
VINCORE	5	I	Input voltage for VCORE step-down converter. This must be connected to the same voltage supply as VINMAIN and VCC.
L2	4		Switch pin of VCORE converter. The VCORE inductor is connected here.
VCORE	48	I	VCORE feedback voltage sense input, connect directly to VCORE
PGND2	46		Power ground for VCORE converter
LDO REGULATOR SECTION			
AGND1	21		Analog ground connection. All analog ground pins are connected internally on the chip.
VINLDO1	22	I	Input voltage for LDO1
VLDO1	24	O	Output voltage for LDO1
VFB_LDO1	23	I	Feedback input from external resistive divider for LDO1
VINLDO2	19	I	Input voltage for LDO2
VLDO2	20	O	Output and feedback voltage for LDO2
DRIVER SECTION			
LED2	2	O	LED driver, with blink rate programmable via serial interface
VIB	3	O	Vibrator driver, enabled via serial interface
CONTROL AND I2C SECTION			
PS_SEQ	14	I	Sets power-up/down sequence of step-down converters
PB_ONOFF	47	I	Push-button enable pin, also used to wakeup processor from <i>low-power</i> mode
BATT_COVER	39	I	Indicates if battery cover is in place
HOT_RESET	31	I	Push-button reset input used to reboot or wakeup processor via TPS65013
MPU_RESET	32	O	Open-drain reset output generated by user activated HOT_RESET
RESPWRON	33	O	Open-drain system reset output, generated according to the state of the VMAIN output voltage. If the main output is disabled, RESPWRON is active (i.e., low).
TPOR	27	I	Sets the reset delay time at RESPWRON. TPOR = 0: $T_{n(\text{RESPWRON})} = 100 \text{ ms}$. TPOR = 1: $T_{n(\text{RESPWRON})} = 1 \text{ s}$.

PIN ASSIGNMENTS (continued)
Terminal Functions (continued)

TERMINAL NAME	NO.	I/O	DESCRIPTION
CHARGER SECTION			
PWRFAIL	34	O	Open-drain output. Active low when UVLO comparator indicates low VBAT condition or when shutdown is about to occur due to an overtemperature condition or when the battery cover is removed (BATT_COVER has gone low).
INT	35	O	Indicates a charge fault or termination, or if any of the regulator outputs are below the lower tolerance level, active low (open drain)
LOW_PWR	36	I	Input signal indicating deep-sleep mode, V _{CORE} is lowered to predefined value or disabled
DEFMAIN	12	I	Input signal indicating default V _{MAIN} voltage, 0 = 1.8 V, 1 = 3.3 V
DEFCORE	1	I	Input signal indicating default V _{CORE} voltage, 0 = 1.3 V, 1 = 1.6 V
SCLK	30	I	Serial interface clock line
SDAT	29	I/O	Serial interface data/address
IFLSB	28	I	LSB of serial interface address used to distinguish two devices with the same address
GPIO1	26	I/O	General-purpose open-drain input/output
GPIO2	25	I/O	General-purpose open-drain input/output
GPIO3	18	I/O	General-purpose open-drain input/output
GPIO4	17	I/O	General-purpose open-drain input/output

FUNCTIONAL BLOCK DIAGRAM

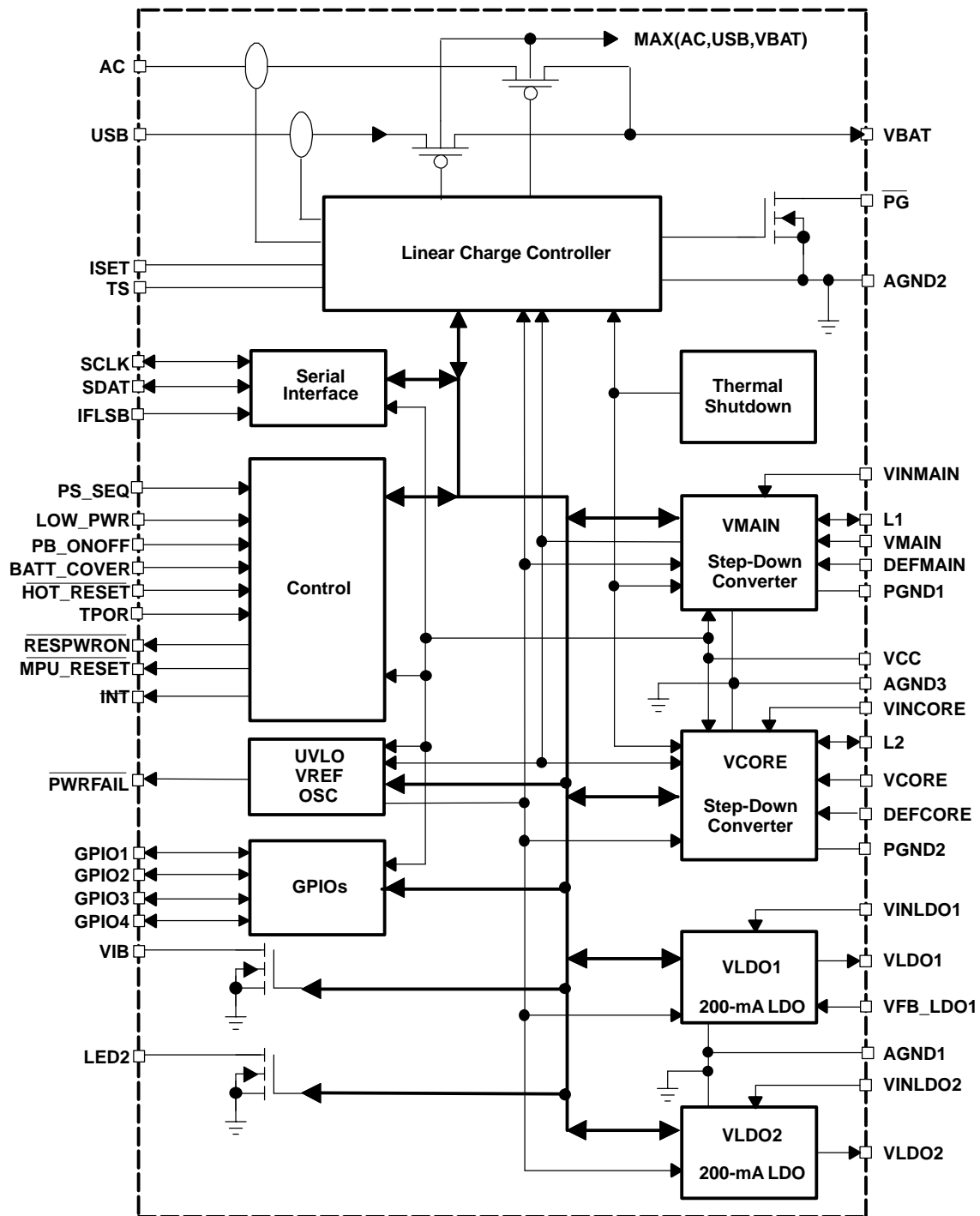

TYPICAL CHARACTERISTICS

Table of Graphs

		FIGURE
Efficiency	vs Output current	1-4
Quiescent current	vs Input voltage	5
Switching frequency	vs Temperature	6
LDO1 Output voltage	vs Output current	7, 8, 9
LDO2 Output voltage	vs Output current	10
Line transient response (main)		11
Line transient response (core)		12
Line transient response (LDO1)		13
Line transient response (LDO2)		14
Load transient response (core)		15
Load transient response (main)		16
Load transient response (LDO1)		17
Load transient response (LDO2)		18
Output Ripple (PWM = 0)		19
Output Ripple (PWM = 1)		20
Start-up timing		21
Dropout voltage	vs Output current	22, 23
PSRR (LDO1 and LDO2)	vs Frequency	24

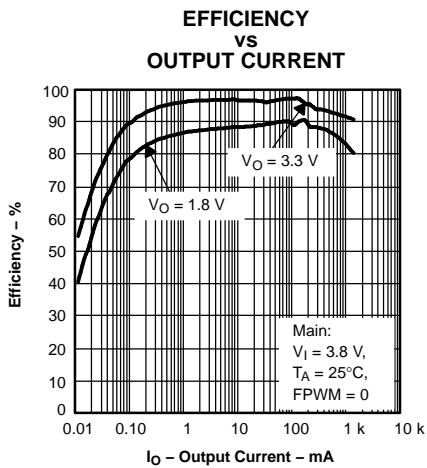

Figure 1.

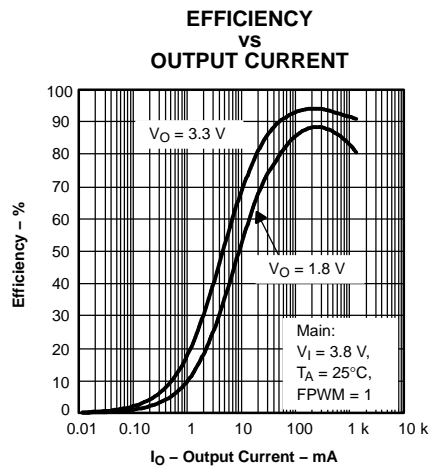

Figure 2.

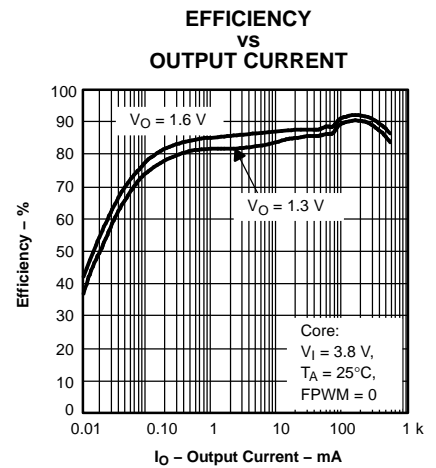

Figure 3.

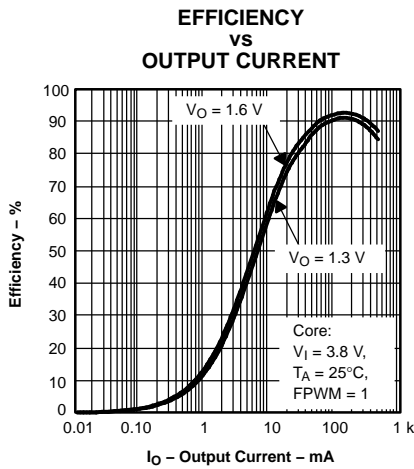

Figure 4.

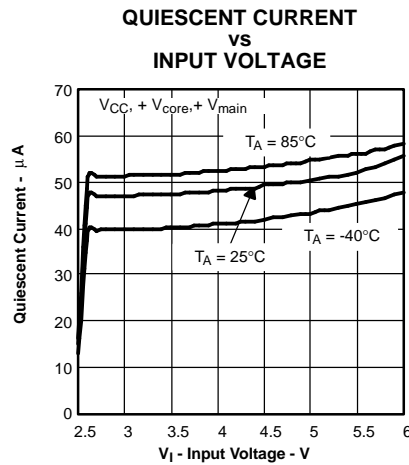

Figure 5.

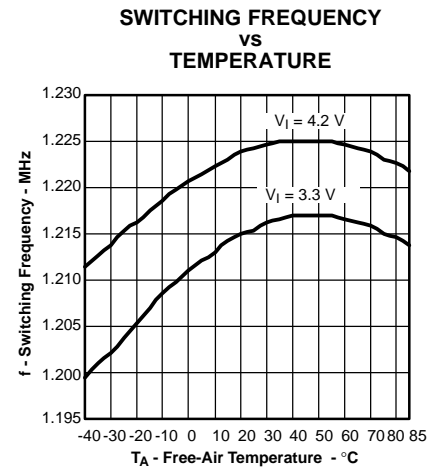

Figure 6.

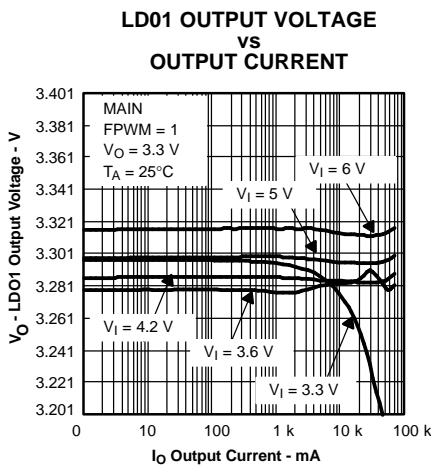

Figure 7.

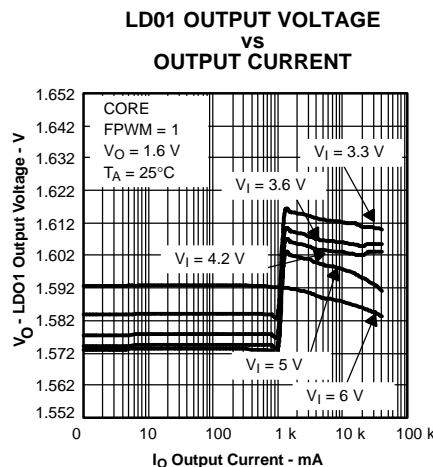

Figure 8.

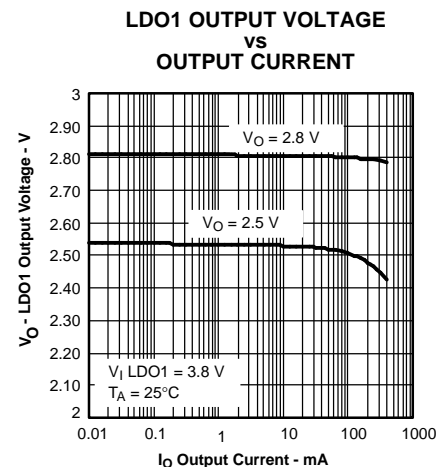

Figure 9.

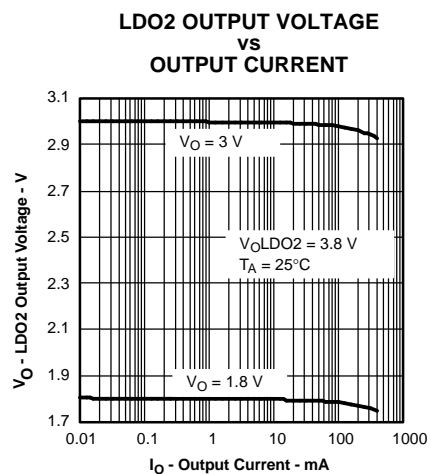

Figure 10.

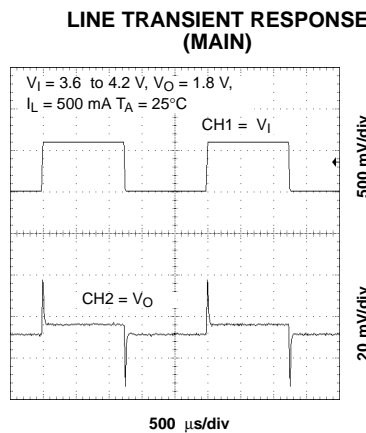

Figure 11.

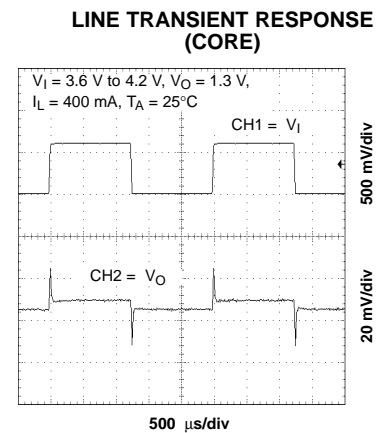

Figure 12.

LINE TRANSIENT RESPONSE
(LDO1)

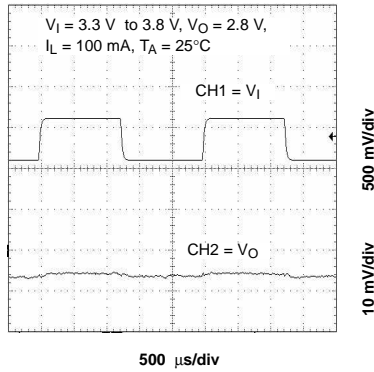

Figure 13.

LINE TRANSIENT RESPONSE
(LDO2)

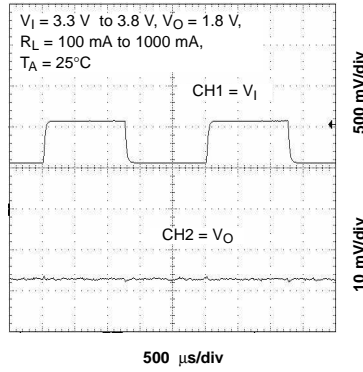

Figure 14.

LOAD TRANSIENT RESPONSE
(CORE)

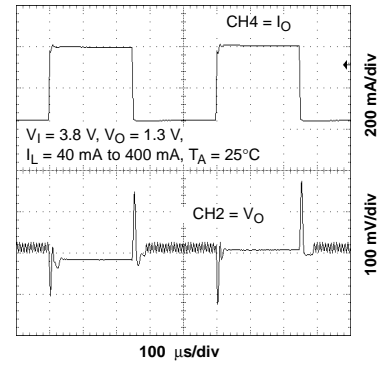

Figure 15.

LOAD TRANSIENT RESPONSE
(MAIN)

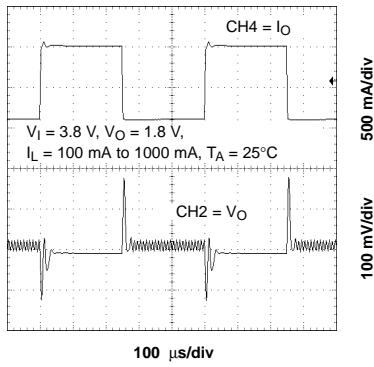

Figure 16.

LOAD TRANSIENT RESPONSE
(LDO1)

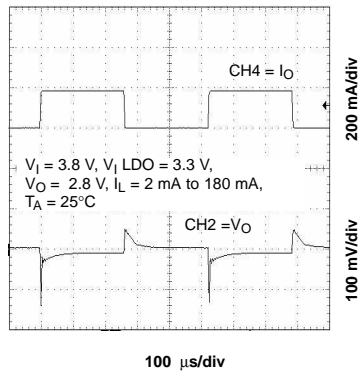

Figure 17.

LOAD TRANSIENT RESPONSE
(LDO2)

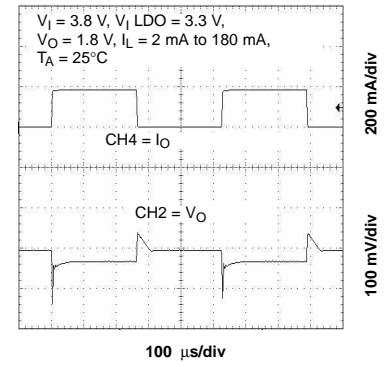

Figure 18.

OUTPUT RIPPLE (PWM = 0)

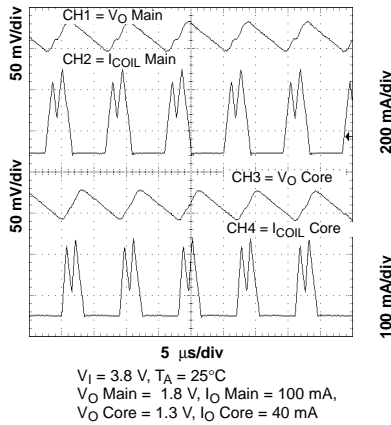

Figure 19.

OUTPUT RIPPLE (PWM = 1)

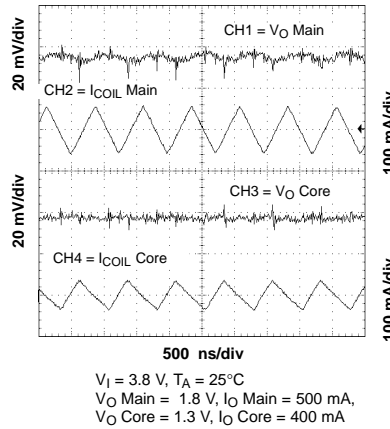

Figure 20.

START-UP TIMING

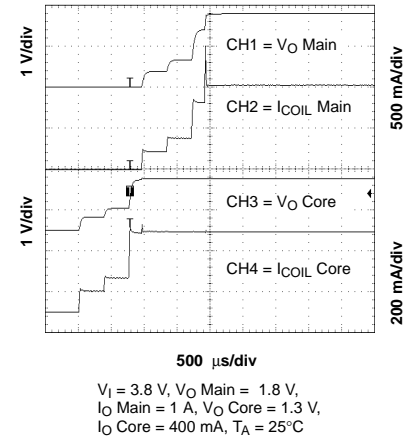

Figure 21.

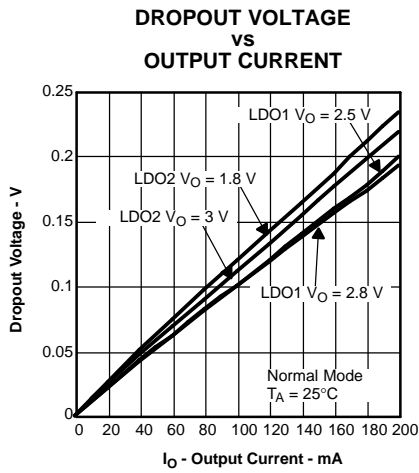

Figure 22.

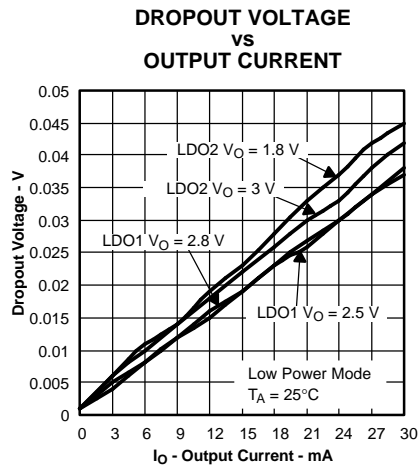

Figure 23.

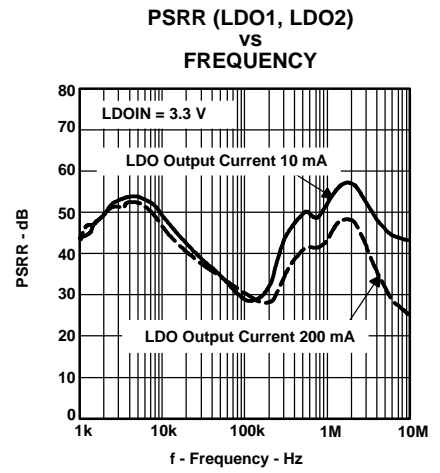

Figure 24.

APPLICATION INFORMATION

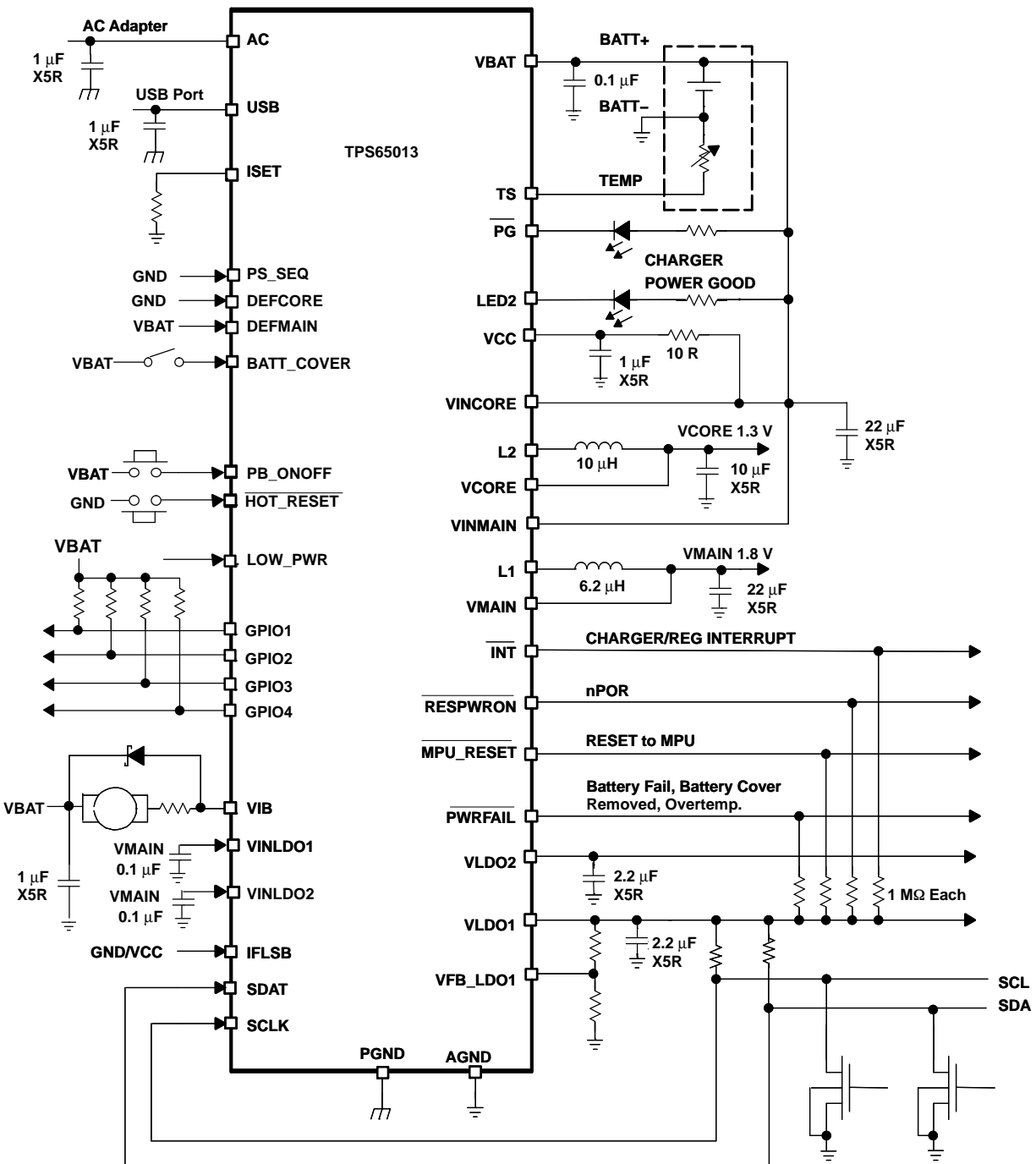

Figure 25. Typical Application Circuit

The VCORE and VMAIN converter are always enabled in a typical application. The VCORE output voltage can be disabled or reduced from 1.3 V to a lower, preset voltage under processor control. When the processor enters the sleep mode, a high signal on the LOW_PWR pin initiates the change.

VCORE typically supplies the digital part of the audio codec. When the processor is in sleep or low-power mode, the audio codec is powered off, so the VCORE voltage can be programmed to lower voltages without a problem. A typical audio codec (e.g., TI AIC23) consumes about 20-mA to 30-mA current from the VCORE power supply.

DETAILED DESCRIPTION

BATTERY CHARGER

The TPS65013 supports a precision Li-ion or Li-polymer charging system suitable for single cells with either coke or graphite anodes. Charging the battery is possible even without the application processor being powered up. The TPS65013 starts charging when an input voltage on either ac or USB input is present, which is greater than the charger UVLO threshold. See Figure 27 for a typical charge profile.

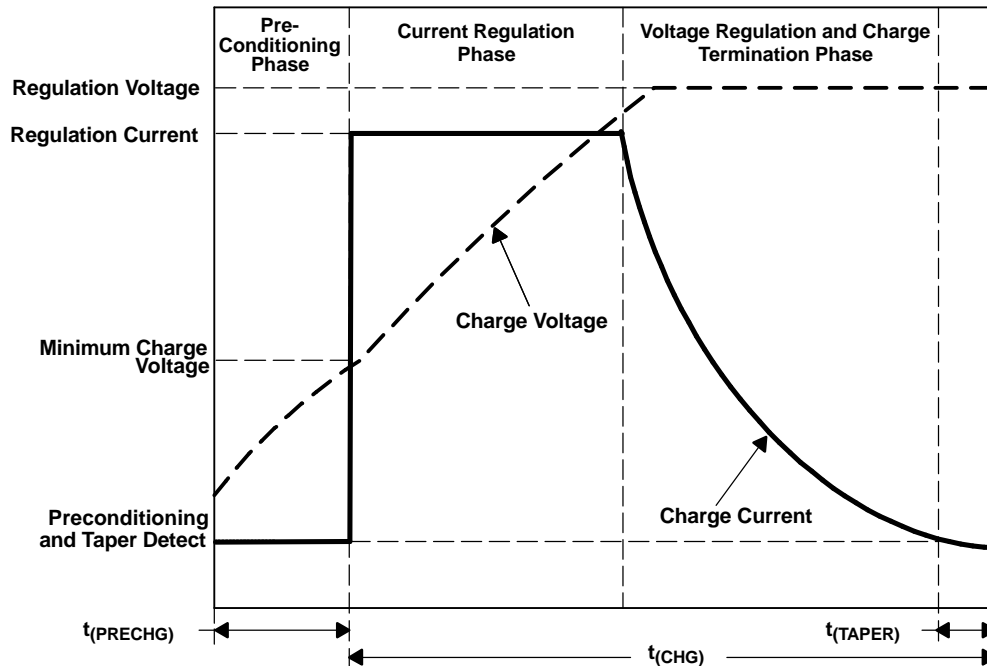

Figure 27. Typical Charging Profile

Autonomous Power Source Selection

Per default the TPS65013 attempts to charge from the ac input. If ac input is not present, the USB is selected. If both inputs are available, the ac input has priority. The charge current is initially limited to 100 mA when charging from the USB input. This can be increased to 500 mA via the serial interface. The charger can be completely disabled via the interface, and it is also possible just to disable charging from the USB port. The start of the charging process from the USB port is delayed in order to allow the application processor time to disable USB charging, for instance if a USB OTG port is recognized. The recommended input voltage for charging from the ac input is $4.5\text{ V} < V_{(AC)} < 5.5\text{ V}$. However, the TPS65013 is capable of withstanding (but not charging from) up to 20 V. Charging is disabled if $V_{(AC)}$ is greater than typically 6.6 V.

Temperature Qualification

The TPS65013 continuously monitors battery temperature by measuring the voltage between the TS and AGND pins. An internal current source provides the bias for most common 10K negative-temperature coefficient thermistors (NTC) (see Figure 28). The IC compares the voltage on the TS pin against the internal $V_{(LTF)}$ and $V_{(HTF)}$ thresholds to determine if charging is allowed. Once a temperature outside the $V_{(LTF)}$ and $V_{(HTF)}$ thresholds is detected, the IC immediately suspends the charge. The IC suspends charge by turning off the power FET and holding the timer value (i.e., timers are *not* reset). Charge is resumed when the temperature returns to the normal range.

The allowed temperature range for 103AT type thermistor is 0°C to 45°C. However, the user may modify these thresholds by adding two external resistors. See Figure 29.

DETAILED DESCRIPTION (continued)

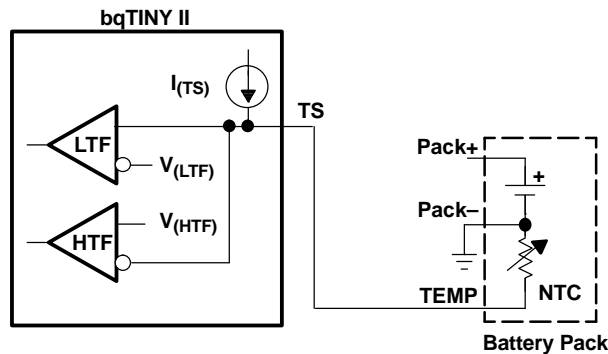

Figure 28. TS Pin Configuration

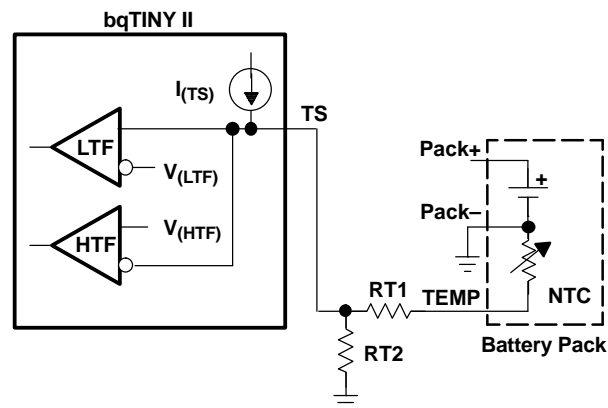

Figure 29. TS Pin Threshold

Battery Preconditioning

On power up, if the battery voltage is below the $V_{(LOWV)}$ threshold, the TPS65013 applies a precharge current, $I_{(PRECHG)}$, to the battery. This feature revives deeply discharged cells. The charge current during this phase is one-tenth of the value in current regulation phase which is set with $I_{O(out)} = KSET \times V_{(SET)}/R_{(SET)}$. The load current in preconditioning phase must be lower than $I_{(PRECHG)}$ and must allow the battery voltage to rise above $V_{(LOWV)}$ within $t_{(Prechg)}$. VBAT_A is the sense pin to the voltage comparator for the battery voltage. This allows a power-on sense measurement if the VBAT_A and VBAT_B pins are connected together at the battery.

The TPS65013 activates a safety timer, $t_{(PRECHG)}$, during the conditioning phase. If $V_{(LOWV)}$ threshold is not reached within the timer period, the TPS65013 turns off the charger and indicates the fault condition in the CHGSTATUS register. In the case of a fault condition, the TPS65013 reduces the current to $I_{(DETECT)}$. $I_{(DETECT)}$ is used to detect a battery replacement condition. Fault condition is cleared by POR or battery replacement or via the serial interface.

Battery Charge Current

TPS65013 offers on-chip current regulation. When charging from an ac adapter, a resistor connected between the ISET1 and AGND pins determines the charge rate. A maximum of 1-A charger current from the ac adapter is allowed. When charging from a USB port either a 100-mA or 500-mA charge rate can be selected via the serial interface, default is 100 mA maximum. Two bits are available in the CHGCONFIG register in the serial interface to reduce the charge current in 25% steps. These only influence charging from the ac input and may be of use if charging is often suspended due to excessive junction temperature in the TPS65013 (e.g., at high ac input voltages) and low battery voltages.

DETAILED DESCRIPTION (continued)

Battery Voltage Regulation

The voltage regulation feedback is through the VBAT pin. This pin is tied directly to the positive side of the battery pack. The TPS65013 monitors the battery-pack voltage between the VBAT and AGND pins. The TPS65013 is offered in a fixed-voltage version of 4.2 V.

As a safety backup, the TPS65013 also monitors the charge time in the fast-charge mode. If taper current is not detected within this time period, $t_{(CHG)}$, the TPS65013 turns off the charger and indicates FAULT in the CHGSTATUS register. In the case of a FAULT condition, the TPS65013 reduces the current to $I_{(DETECT)}$. $I_{(DETECT)}$ is used to detect a battery replacement condition. Fault condition is cleared by POR via the serial interface. Note that the safety timer is reset if the TPS65013 is forced out of the voltage regulation mode. The fast-charge timer is disabled by default to allow charging during normal operation of the end equipment. It is enabled via the CHGCONFIG register.

Charge Termination and Recharge

The TPS65013 monitors the charging current during the voltage regulation phase. Once the taper threshold, $I_{(TAPER)}$, is detected, the TPS65013 initiates the taper timer, $t_{(TAPER)}$. Charge is terminated after the timer expires. The TPS65013 resets the taper timer in the event that the charge current returns above the taper threshold, $I_{(TAPER)}$. After a charge termination, the TPS65013 restarts the charge once the voltage on the VBAT pin falls below the $V_{(RCH)}$ threshold. This feature keeps the battery at full capacity at all times. The fast charge timer and the taper timer must be enabled by programming CHGCONFIG(5)=1. A thermal suspend suspends the fast-charge and taper timers.

In addition to the taper current detection, the TPS65013 terminates charge in the event that the charge current falls below the $I_{(TERM)}$ threshold. This feature allows for quick recognition of a battery removal condition. When a full battery is replaced with an empty battery, the TPS65013 detects that the VBAT voltage is below the recharge threshold and starts charging the new battery. The taper and termination bits are cleared in the CHGSTATUS register and if the \overline{INT} pin is still active due to these two interrupt sources, then it is de-asserted. Depending on the transient seen at the VCC pin, all registers may be set to their default values and require reprogramming with any nondefault values required, such as enabling the fast-charge timer and taper termination; this should only happen if VCC drops below approximately 2 V.

Sleep Mode

The TPS65013 charger enters the low-power sleep mode if both input sources are removed from the circuit. This feature prevents draining the battery during the absence of input power.

\overline{PG} Output

The open-drain, power-good (\overline{PG}) output indicates when a valid power supply is present for the charger. This can be either from the ac adapter input or from the USB. The output turns ON when a valid voltage is detected. A valid voltage is detected whenever the voltage on either pin AC or pin USB rises above the voltage on VBAT plus 100 mV. This output is turned off in the sleep mode. The \overline{PG} pin can be used to drive an LED or communicate to the host processor. A voltage greater than the $V_{(CHGOVLO)}$ threshold (typ 6.6 V) at the AC input is not valid and does not activate the \overline{PG} output. The \overline{PG} output is held in high impedance state if the charger is in reset by programming CHGCONFIG(6)=1.

The \overline{PG} output can also be programmed via the LED1_ON and LED1_PER registers in the serial interface. It can then be programmed to be permanently on, off, or to blink with defined on- and period-times. \overline{PG} is controlled per default via the charger.

DETAILED DESCRIPTION (continued)

Thermal Considerations for Setting Charge Current

The TPS65013 is housed in a 48-pin QFN package with exposed leadframe on the underside. This 7 mm × 7 mm package exhibits a thermal impedance (junction-to-ambient) of 33 K/W when mounted on a JEDEC high-k board with zero air flow.

AMBIENT TEMPERATURE	MAX POWER DISSIPATION FOR $T_J = 125^\circ\text{C}$	DERATING FACTOR ABOVE $T_A = 55^\circ\text{C}$
25°C	3 W	30 mW/°C
55°C	2.1 W	

Consideration needs to be given to the maximum charge current when the assembled application board exhibits a thermal impedance, which differs significantly from the JEDEC high-k board. The charger has a thermal shutdown feature, which suspends charging if the TPS65013 junction temperature rises above a threshold of 145°C. This threshold is set 15°C below the threshold used to power down the TPS65013 completely.

STEP-DOWN CONVERTERS, VMAIN AND VCORE

The TPS65013 incorporates two synchronous step-down converters operating typically at 1.25-MHz fixed frequency pulse width modulation (PWM) at moderate-to-heavy load currents. At light load currents, the converters automatically enter power-save mode and operate with PFM. The main converter is capable of delivering 1-A output current and the core converter is capable of delivering 400 mA.

The converter output voltages are programmed via the VDCDC1 and VDCDC2 registers in the serial interface. The main converter defaults to 1.8-V or 3.3-V output voltage depending on the DEFMAIN configuration pin, if DEFMAIN is tied to ground, the default is 1.8 V; if it is tied to V_{CC} , the default is 3.3 V. The core converter defaults to either 1.3 V or 1.6 V depending on whether the DEFCORE configuration pin is tied to GND or to V_{CC} , respectively. Both the main and core output voltages can subsequently be reprogrammed after start-up via the serial interface. In addition, the LOW_PWR pin can be used either to lower the core voltage to a value defined in the VDCDC2 register when the application processor is in deep-sleep mode or to disable the core converter. An active signal at LOW_PWR is ignored if the ENABLE_LP bit is not set in the VDCDC1 register.

The step-down converter outputs (when enabled) are monitored by power-good comparators, the outputs of which are available via the serial interface. The outputs of the dc-dc converters can be optionally discharged when the dc-dc converters are disabled.

During PWM operation, the converters use a unique fast-response voltage mode controller scheme with input voltage feed-forward to achieve good line and load regulation allowing the use of small ceramic input and output capacitors. At the beginning of each clock cycle, initiated by the clock signal, the P-channel MOSFET switch is turned on, and the inductor current ramps up until the comparator trips and the control logic turns off the switch. The current limit comparator also turns off the switch in case the current limit of the P-channel switch is exceeded. After the dead time preventing current shoot through, the N-channel MOSFET rectifier is turned on and the inductor current ramps down. The next cycle is initiated by the clock signal, again turning off the N-channel rectifier and turning on the P-channel switch.

The error amplifier, together with the input voltage, determines the rise time of the saw-tooth generator, and therefore, any change in input voltage or output voltage directly controls the duty cycle of the converter giving a good line and load transient regulation.

The two dc-dc converters operate synchronized to each other, with the MAIN converter as the master. A 270° phase shift between the MAIN switch turnion and the CORE switch turnion decreases the input RMS current, and smaller input capacitors can be used. This is optimized for a typical application where the MAIN converter regulates a Li-ion battery voltage of 3.7 V to 1.8 V and the CORE from 3.7 V to 1.3 V.

Power-Save Mode Operation

As the load current decreases, the converter enters the power-save mode operation. During power-save mode, the converter operates with reduced switching frequency in PFM mode and with a minimum quiescent current to maintain high efficiency.

In order to optimize the converter efficiency at light load, the average current is monitored; if in PWM mode, the inductor current remains below a certain threshold, and then power-save mode is entered. The typical threshold can be calculated as follows:

$$I_{(\text{skipmain})} \times \frac{V_{I(\text{MAIN})}}{17 \Delta} \quad I_{(\text{skipcore})} \times \frac{V_{I(\text{CORE})}}{42 \Delta} \quad (1)$$

During the power-save mode the output voltage is monitored with the comparator by the thresholds comp low and comp high. As the output voltage falls below the comp low threshold, set to typically 0.8% above the nominal V_{out} , the P-channel switch turns on. The converter then runs at 50% of the nominal switching frequency. If the load is below the delivered current, then the output voltage rises until the comp high threshold is reached, typically 1.6% above the nominal V_{out} . At this point, all switching activity ceases, hence reducing the quiescent current to a minimum until the output voltage has dropped below comp low again. If the load current is greater than the delivered current, then the output voltage falls until it crosses the nominal output voltage threshold (comp low 2 threshold), whereupon power-save mode is exited, and the converter returns to PWM mode.

These control methods reduce the quiescent current typically to 12- μA per converter and the switching frequency to a minimum, achieving the highest converter efficiency. Setting the comparator thresholds to typically 0.8% and 1.6% above the nominal output voltage at light load current results in a dynamic voltage positioning achieving lower absolute voltage drops during heavy load transient changes. This allows the converters to operate with a small output capacitor of just 10 μF for the core and 22 μF for the main output and still have a low absolute voltage drop during heavy load transient changes. See Figure 30 for detailed operation of the power-save mode. The power-save mode can be disabled through the I²C interface to force the converters to stay in fixed frequency PWM mode.

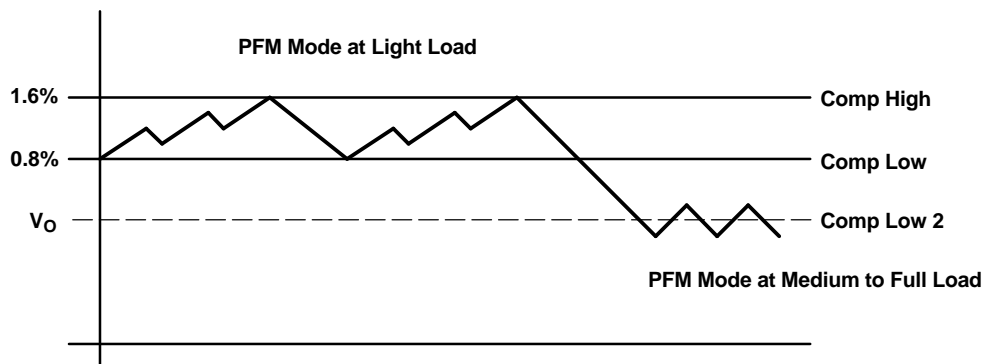

Figure 30. Power-Save Mode Thresholds and Dynamic Voltage Positioning

Forced PWM

The core and main converters are forced into PWM mode by setting bit 7 in the VDCDC1 register. This feature is used to minimize ripple on the output voltages.

Dynamic Voltage Positioning

As described in the power-save mode operation sections and as detailed in Figure 13, the output voltage is typically 1.2% above the nominal output voltage at light load currents as the device is in power-save mode. This gives additional headroom for the voltage drop during a load transient from light load to full load. During a load transient from full load to light load, the voltage overshoot is also minimized due to active regulation turning on the N-channel rectifier switch.

Soft Start

Both converters have an internal soft-start circuit that limits the inrush current during start-up. The soft start is implemented as a digital circuit increasing the switch current in 4 steps up to the typical maximum switch current limit of 700 mA (core) and 1.75 A (main). Therefore, the start-up time mainly depends on the output capacitor and load current.

100% Duty Cycle Low-Dropout Operation

The TPS65013 converters offer a low input to output voltage difference while maintaining operation with the use of the 100% duty cycle mode. In this mode, the P-channel switch is constantly turned on. This is particularly useful in battery-powered applications to achieve longest operation time by taking full advantage of the whole battery voltage range. The minimum input voltage to maintain regulation depends on the load current and output voltage and is calculated as:

$$V_{I(\min)} \geq V_{O(\max)} + I_{O(\max)} \times (r_{DS(on)\max} + R_L) \quad (2)$$

with:

- $I_{O(\max)}$ = maximum output current plus inductor ripple current
- $r_{DS(on)\max}$ = maximum P-channel switch $r_{DS(on)}$
- R_L = dc resistance of the inductor
- $V_{O(\max)}$ = nominal output voltage plus maximum output voltage tolerance

Active Discharge When Disabled

When the CORE and MAIN converters are disabled, due to an UVLO, BATT_COVER or OVERTEMP condition, it is possible to actively pull down the outputs. This feature is disabled per default and is individually enabled via the VDCDC1 and VDCDC2 registers in the serial interface. When this feature is enabled, the core and main outputs are discharged by a 400-Ω (typical) load.

Power-Good Monitoring

Both the MAIN and CORE converters have power-good comparators. Each comparator indicates when the relevant output voltage has dropped 10% below its target value, with 5% hysteresis. The outputs of these comparators are available in the REGSTATUS register via the serial interface. A maskable interrupt is generated when any voltage rail drops below the 10% threshold. The comparators are disabled when the converters are disabled. The status of the power-good comparator for VMAIN is used to generate the RESPWRON signal.

Overtemperature Shutdown

The MAIN and CORE converters are automatically shut down if the temperature exceeds the trip point (see the electrical characteristics). This detection is only active if the converters are in PWM mode, either by setting FPWM = 1, or if the output current is high enough that the device runs in PWM mode automatically.

LOW-DROPOUT VOLTAGE REGULATORS

The low-dropout voltage regulators are designed to operate with low value ceramic input and output capacitors. They operate with input voltages down to 1.8 V. The LDOs offer a maximum dropout voltage of 300 mV at rated output current. Each LDO has a current limit feature. Both LDOs are enabled per default; both LDOs can be disabled or programmed via the serial interface using the VREGS1 register. The LDO outputs (when enabled) are monitored by power-good comparators, the outputs of which are available via the serial interface. The LDOs also have reverse conduction prevention when disabled. This allows the possibility to connect external regulators in parallel in systems with a backup battery.

Power-Good Monitoring

Both the LDO1 and LDO2 linear regulators have power-good comparators. Each comparator indicates when the relevant output voltage has dropped 10% below its target value, with 5% hysteresis. The outputs of these comparators are available in the REGSTATUS register via the serial interface. An interrupt is generated when any voltage rail drops below the 10% threshold. The LDO2 comparator is disabled when LDO2 is disabled.

Enable and Sequencing

Enabling and sequencing of the dc-dc converters and LDOs are described in the power-up sequencing section. The OMAP1710 processor from Texas Instruments requires that the core power supply is enabled before the I/O power supply, which means that the CORE converter should power up before the MAIN converter. This is achieved by connecting PS_SEQ to GND.

UNDERVOLTAGE LOCKOUT

The undervoltage lockout circuit for the four regulators on TPS65013 prevents the device from malfunctioning at low input voltages and from excessive discharge of the battery. Basically, it prevents the converter from turning on the power switch or rectifier FET under undefined conditions. The undervoltage threshold voltage is set by default to 2.75 V. After power up, the threshold voltage can be reprogrammed through the serial interface. The undervoltage lockout comparator compares the voltage on the VCC pin with the UVLO threshold. When the VCC voltage drops below this threshold, the TPS65013 sets the $\overline{PWRFAIL}$ pin low and after a time $t_{(UVLO)}$ disables the voltage regulators in the sequence defined by PS_SEQ . The same procedure is followed when the TPS65013 detects that its junction temperature has exceeded the overtemperature threshold, typically 160°C, with a delay $t_{(overtemp)}$. The TPS65013 automatically restarts when the UVLO (or overtemperature) condition is no longer present.

The battery charger circuit has a separate UVLO circuit with a threshold of typically 2.5 V, which is compared with the voltage on AC and USB supply pins.

POWER-UP SEQUENCING

The TPS65013 power-up sequencing is designed to allow the maximum flexibility without generating excessive logistical or system complexity. The relevant control pins are described in the following table:

Table 1. Control Pins

PIN NAME	INPUT/OUTPUT	FUNCTION
PS_SEQ	I	Input signal indicating power-up and power-down sequence of the switching converters. PS_SEQ = 0 forces the core regulator to ramp up first and down last. PS_SEQ = 1 forces the main regulator to ramp up first and down last.
DEFCORE	I	Defines the default voltage of the VCORE switching converter. DEFCORE = 0 defaults VCORE to 1.3 V, DEFCORE = VCC defaults VCORE to 1.6 V.
DEFMAIN	I	Defines the default voltage of the VMAIN switching converter. DEFMAIN = 0 defaults VMAIN to 1.8 V, DEFMAIN = VCC defaults VMAIN to 3.3 V.
LOW_PWR	I	The LOW_PWR pin is used to lower VCORE to the preset voltage in the VDCDC2 register when the processor is in deep-sleep mode. Alternatively, VCORE can be disabled in low-power mode if the LP_COREOFF bit is set in the VDCDC2 register. LOW_PWR is ignored if the ENABLE LP bit is not set in the VDCDC1 register. The TPS65013 uses the rising edge of the internal signal formed by a logical AND of LOW_PWR and ENABLE LP to enter low-power mode. TPS65013 is forced out of low-power mode by de-asserting LOW_PWR, by resetting ENABLE LP to 0, by activating the PB_ONOFF pin or by activating the HOT_RESET pin. There are two ways to get the device back into low-power mode: a) toggle the LOW_PWR pin, or b) toggle the low-power bit when the LOW_PWR pin is held high. The LOW_PWR pin is also used to set the TPS65013 into WAIT mode. If USB or AC is present, the AUA bit (CHCONFIG<7>) must be set to enter the WAIT mode, see Figure 31.
PB_ONOFF	I	PB_ONOFF can be used to exit the low-power mode and return the core voltage to the value before low-power mode was entered. If PB_ONOFF is used to exit the low-power mode, then the low-power mode can be reentered by toggling the LOW_PWR pin or by toggling the low-power bit when the LOW_PWR pin is held high. A 1-M Ω pull-down resistor is integrated in TPS65013. PB_ONOFF is internally de-bounced by the TPS65013. A maskable interrupt is generated when PB_ONOFF is activated.
HOT_RESET	I	The HOT_RESET pin has a similar functionality to the PB_ONOFF pin. In addition, it generates a reset (MPU_RESET) for the MPU when the VCORE voltage is in regulation. HOT_RESET does not alter any TPS65013 settings unless low-power mode was active, in which case it is exited. A 1-M Ω pull-up resistor to VCC is integrated in TPS65013. HOT_RESET is internally de-bounced by the TPS65013.
BATT_COVER	I	The BATT_COVER pin is used as an early warning that the main battery is about to be removed. BATT_COVER = VCC indicates that the cover is in place, BATT_COVER = 0 indicates that the cover is not in place. TPS65013 generates a maskable interrupt when the BATT_COVER pin goes low. PWRFAIL is also held low when BATT_COVER goes low. This feature may be disabled by tying BATT_COVER permanently to VCC. The TPS65013 shuts down the main and the core converter and sets the LDOs into low-power mode. A 2-M Ω pull-down resistor is integrated in the TPS65013 at the BATT_COVER pin. BATT_COVER is internally de-bounced by the TPS65013.
RESPWRON	O	RESPWRON is held low while the switching converters (and any LDO's defined as default on) are starting up. It is determined by the state of MAIN's output voltage; when the voltage is higher than the power-good comparator threshold, then RESPWRON is high, when VMAIN is low, then RESPWRON is low. RESPWRON is held low for $t_{n(RESPWRON)}$ seconds after VMAIN has settled.
MPU_RESET	O	MPU_RESET can be used to reset the processor if the user activates the HOT_RESET button. The MPU_RESET output is active for $t_{(MPU_nRESET)}$ seconds. It also forces TPS65013 to leave low-power mode. MPU_RESET is also held low as long as RESPWRON is held low.
PWRFAIL	O	PWRFAIL indicates when $V_{CC} < V_{(UVLO)}$, when the TPS65013 is about to shut down due to an internal overtemperature condition or when BATT_COVER is low. PWRFAIL is also held low as long as RESPWRON is held low.
TPOR	I	TPOR is used to set the delay time for the RESPWRON reset signal. TPOR = 0 sets the delay time to 100 ms. TPOR = 1 sets the delay time to 1 s.

Figure 31 shows the state diagram for the TPS65013 power sequencing. The charger function is not shown in the state diagram since this function is independent of these states.

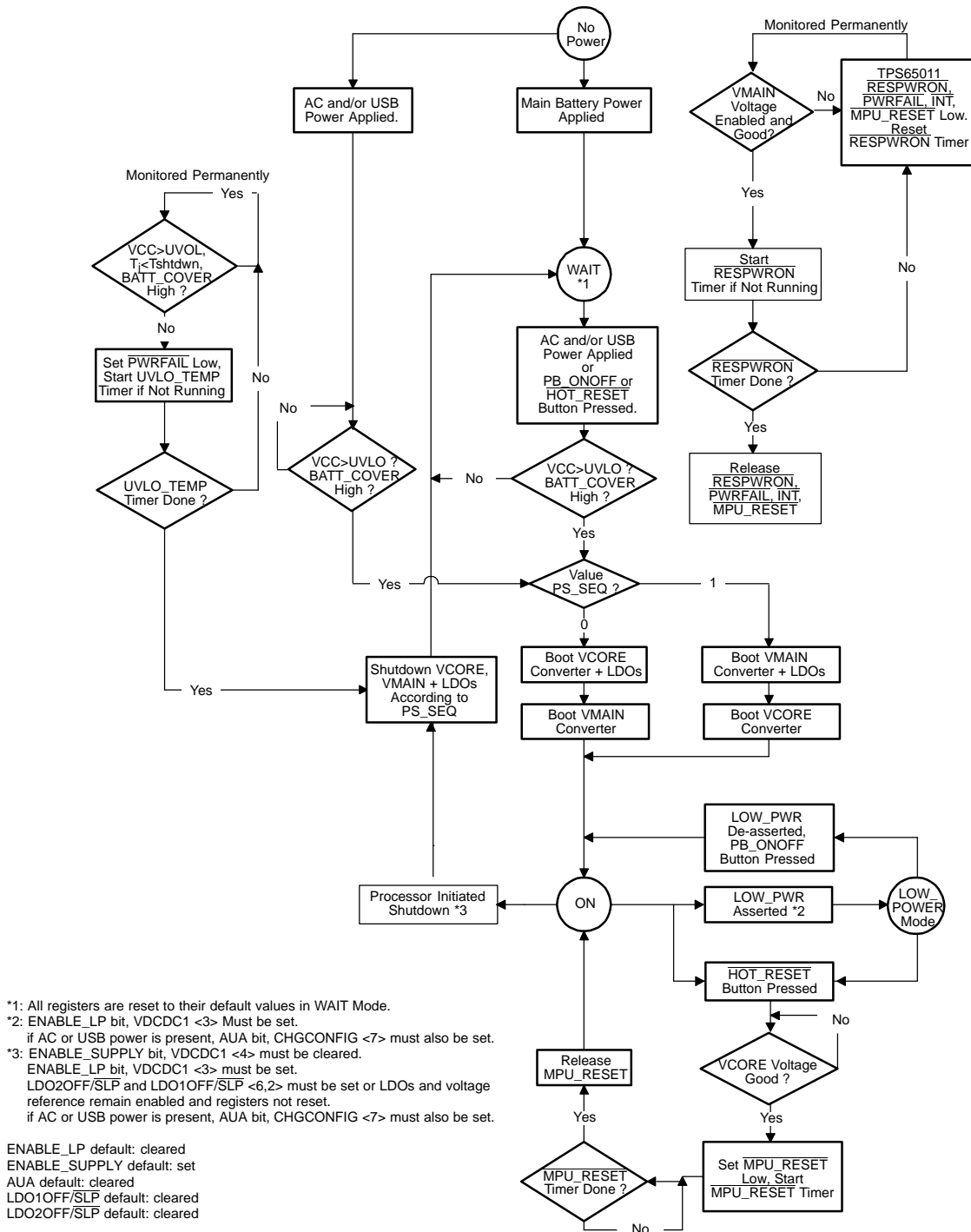

Figure 31. TPS65013 Power-On State Diagram

TPS65013 Power States Description

State 1: No Power

No batteries are connected to the TPS65013. When main power is applied, the bandgap reference, LDOs, and UVLO comparator start up. The $\overline{\text{RESPWRON}}$, $\overline{\text{PWRFAIL}}$, $\overline{\text{INT}}$ and $\overline{\text{MPU_RESET}}$ signals are held low. When BATT_COVER goes high (de-bounced internally by the TPS65013), indicating that the battery cover has been put in place and if $\text{VCC} > \text{UVLO}$, the power supplies are ramped in the sequence defined by PS_SEQ . $\overline{\text{RESPWRON}}$, $\overline{\text{PWRFAIL}}$, $\overline{\text{INT}}$ and $\overline{\text{MPU_RESET}}$ are released when the $\overline{\text{RESPWRON}}$ timer has timed out after $t_{n(\overline{\text{RESPWRON}})}$ seconds. If VCC remains valid and no OVERTEMP condition occurs, then the TPS65013 arrives in State 2: ON. If $\text{VCC} < \text{UVLO}$, the TPS65013 keeps the bandgap reference and UVLO comparator active such that when $\text{VCC} > \text{UVLO}$ (during battery charge) the supplies are automatically activated.

State 2: ON

In this state, TPS65013 is fired up and ready to go. The switching converters can have their output voltages programmed. The LDOs can be disabled or programmed. TPS65013 can exit this state either due to an overtemperature condition, by an undervoltage condition at VCC , by BATT_COVER going low, or by the processor programming low-power mode. State 2 is left temporarily if the user activates the $\overline{\text{HOT_RESET}}$ pin.

State 3: Low-Power Mode

This state is entered via the processor setting the ENABLE_LP bit in the serial interface and then raising the LOW_PWR pin. The TPS65013 actually uses the rising edge of the internal signal formed by a logical AND of the LOW_PWR and ENABLE_LP signals to enter low-power mode. The VMAIN switching converter remains active, but the VCORE converter may be disabled in low-power mode via the serial interface by setting the LP_COREOFF bit in the VDCDC2 register. If left enabled, the VCORE voltage is set to the value predefined by the CORELP0/1 bits in the VDCDC2 register. The LDO1OFF/nSLP and LDO2OFF/nSLP bits in the VREGS1 register determine whether the LDOs are turned off or put in a reduced power mode (transient speed-up circuitry disabled in order to minimize quiescent current) in low-power mode. All TPS65013 features remain addressable via the serial interface. TPS65013 can exit this state either due to an undervoltage condition at VCC , due to BATT_COVER going low, due to an OVERTEMP condition, by the processor deasserting the LOW_POWER pin, or by the user activating the $\overline{\text{HOT_RESET}}$ pin or the PB_ONOFF pin.

State 4: Shutdown

There are two scenarios for entering this state. The first is from State 1: No Power. As soon as main battery power is applied, the device automatically enters the WAIT mode.

The second scenario occurs when the device is in ON mode and the processor initiates a shutdown by resetting the ENABLE_SUPPLY bit in the VDCDC1 register (ENABLE_LP must be high), and then raising the LOW_PWR pin. When this happens, the power rails are ramped down in the predefined sequence, and all circuitry is then disabled. In this state, the TPS65013 waits for the PB_ONOFF or $\overline{\text{HOT_RESET}}$ pin to be activated before enabling any of the supply rails. When the PB_ONOFF or $\overline{\text{HOT_RESET}}$ pin is activated, the TPS65013 powers up the supplies according to the same constraints as at the initial application of power. Complete shutdown is only achieved by setting the LDO1OFF/nSLP and LDO2OFF/nSLP bits high in the VREGS1 register before activating the shutdown.

In this case, the I^2C interface is deactivated and the registers are reset to their default value after leaving the WAIT mode.

To enter the WAIT mode when USB or AC is present, the AUA bit ($\text{CHCONFIG}\langle 7 \rangle$) must be set. The WAIT mode is automatically left if Bit 7 in register CHCONFIG is set to 0 (default), and a voltage is present at either the AC pin or the USB pin in the appropriate range for charging, and the voltage at V_{CC} is above the UVLO threshold. This feature allows the converters to start up automatically if the device is plugged in for charging.

If all supplies are turned off in WAIT mode, the internal bandgap is switched off, and the internal registers are reset to their default state when the device returns to ON mode.

Table 2 shows possible configurations in LOW-POWER mode and WAIT mode.

Table 2. TPS65013 Possible Configurations

CONVERTER	MAIN	CORE	LDO1	LDO2
LOW-POWER mode	1	0/1	0/1	0/1
WAIT mode	0	0	0/1	0/1

- 0 = converter is disabled
- 1 = converter is enabled

Table 3 indicates the typical quiescent current consumption in each power state.

Table 3. TPS65013 Typical Current Consumption

STATE	TOTAL QUIESCENT CURRENT	QUIESCENT CURRENT BREAKDOWN
1	0	
2	30 μ A - 70 μ A	VMAIN (12 μ A) + VCORE (12 μ A) + LDOs (20 μ A each, max 2) + UVLO + reference + PowerGood
3	30 μ A - 55 μ A	VMAIN (12 μ A) + VCORE (12 μ A) + LDOs (10 μ A each, max 2) + UVLO + reference + PowerGood
4	13 μ A	UVLO + reference circuitry

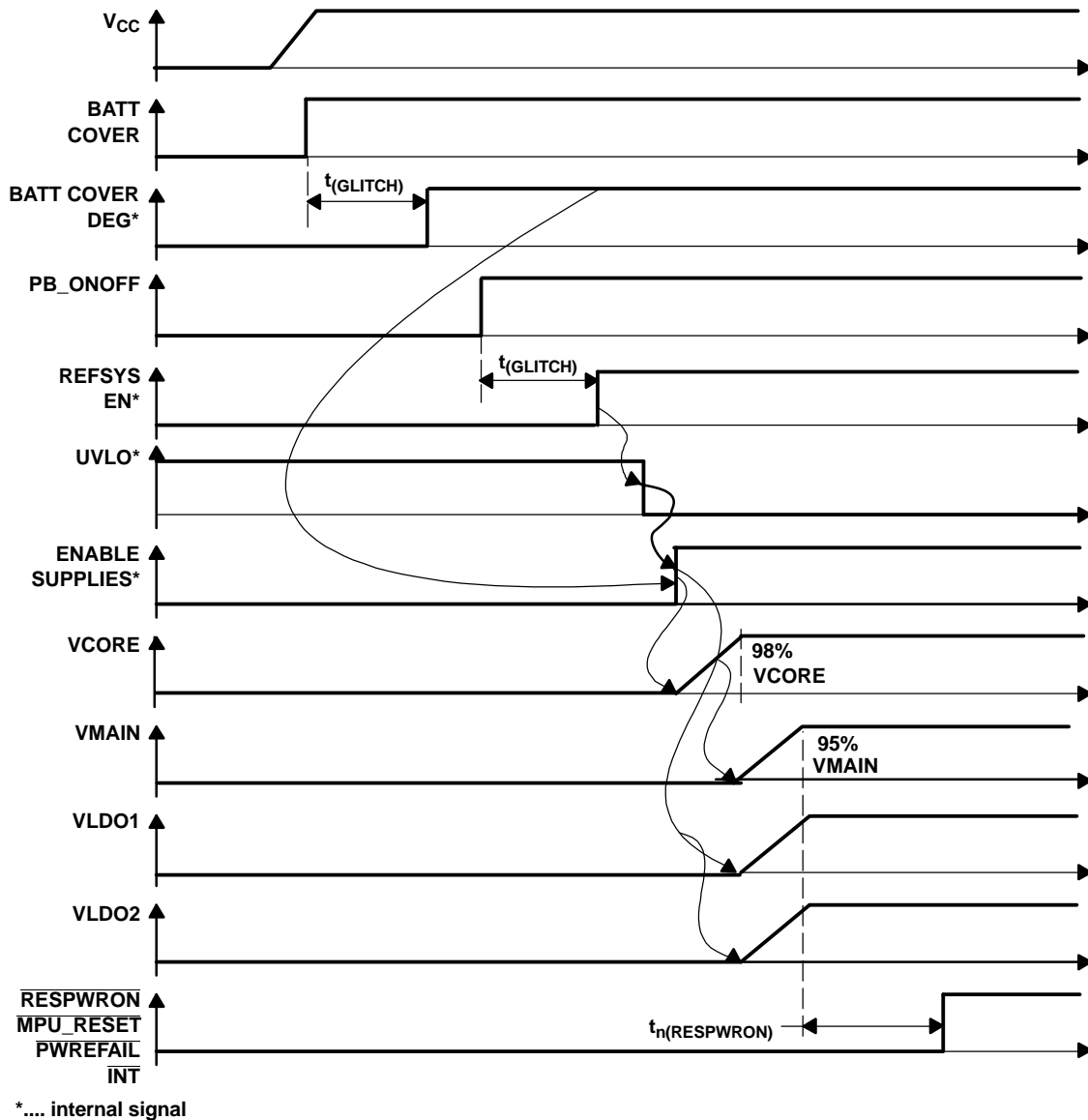
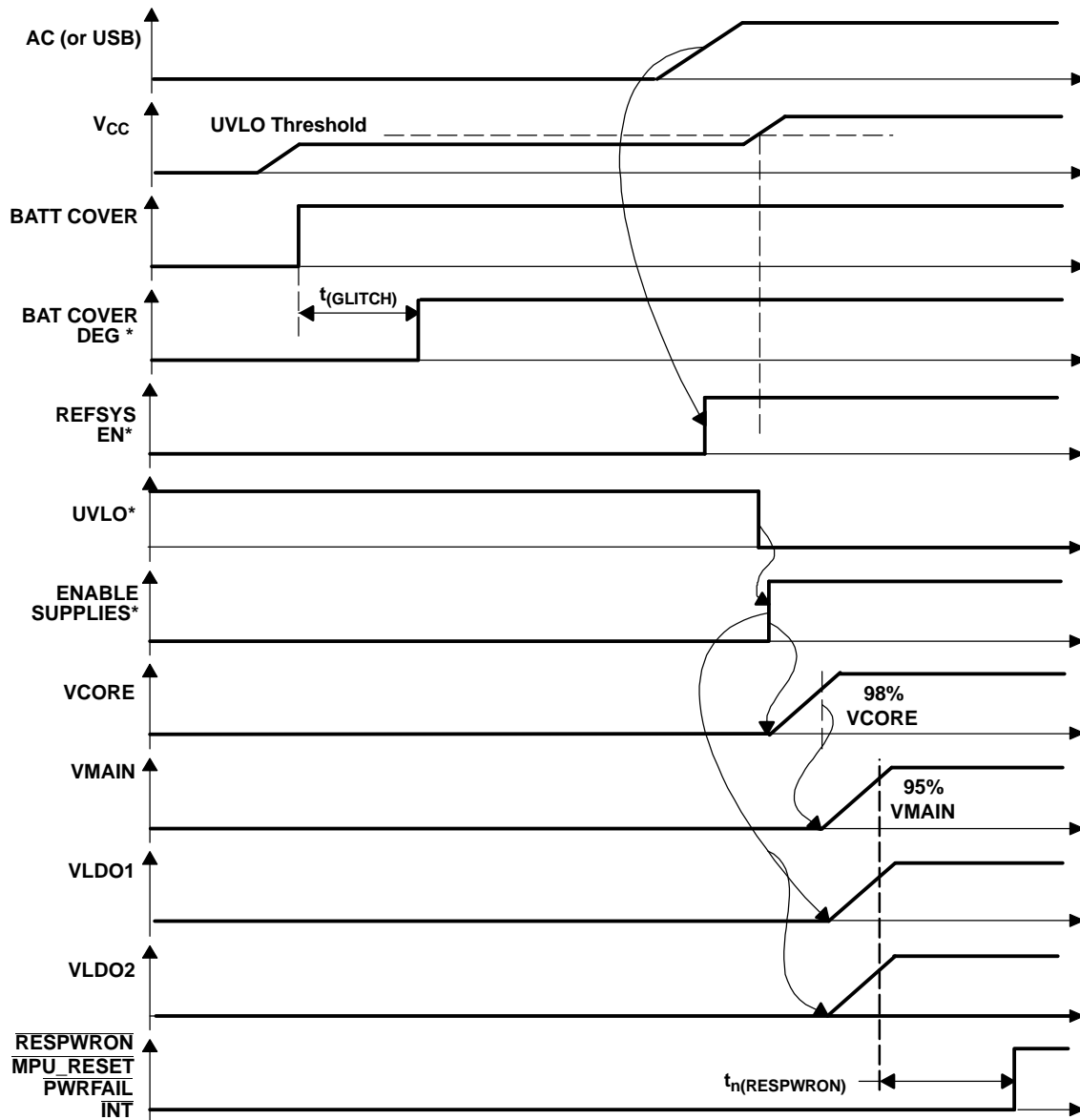

Figure 32. State 1 to State 2 Transition (PS_SEQ=0, $V_{CC} > V_{UVLO} + HYST$)

Valid for LDO1 supplied from VMAIN as described earlier in this *Application Section*.

If 2.4 ms after application, V_{CC} is still below the default UVLO threshold (3.15 V for V_{CC} rising), then start-up is as shown in Figure 33.



*... internal signal

Figure 33. State 1 to State 4 to State 2 Transition (Power up Behavior When Charge Voltage is Applied)

Valid for LDO1 supplied from VMAIN as described earlier in this *Application Section*.

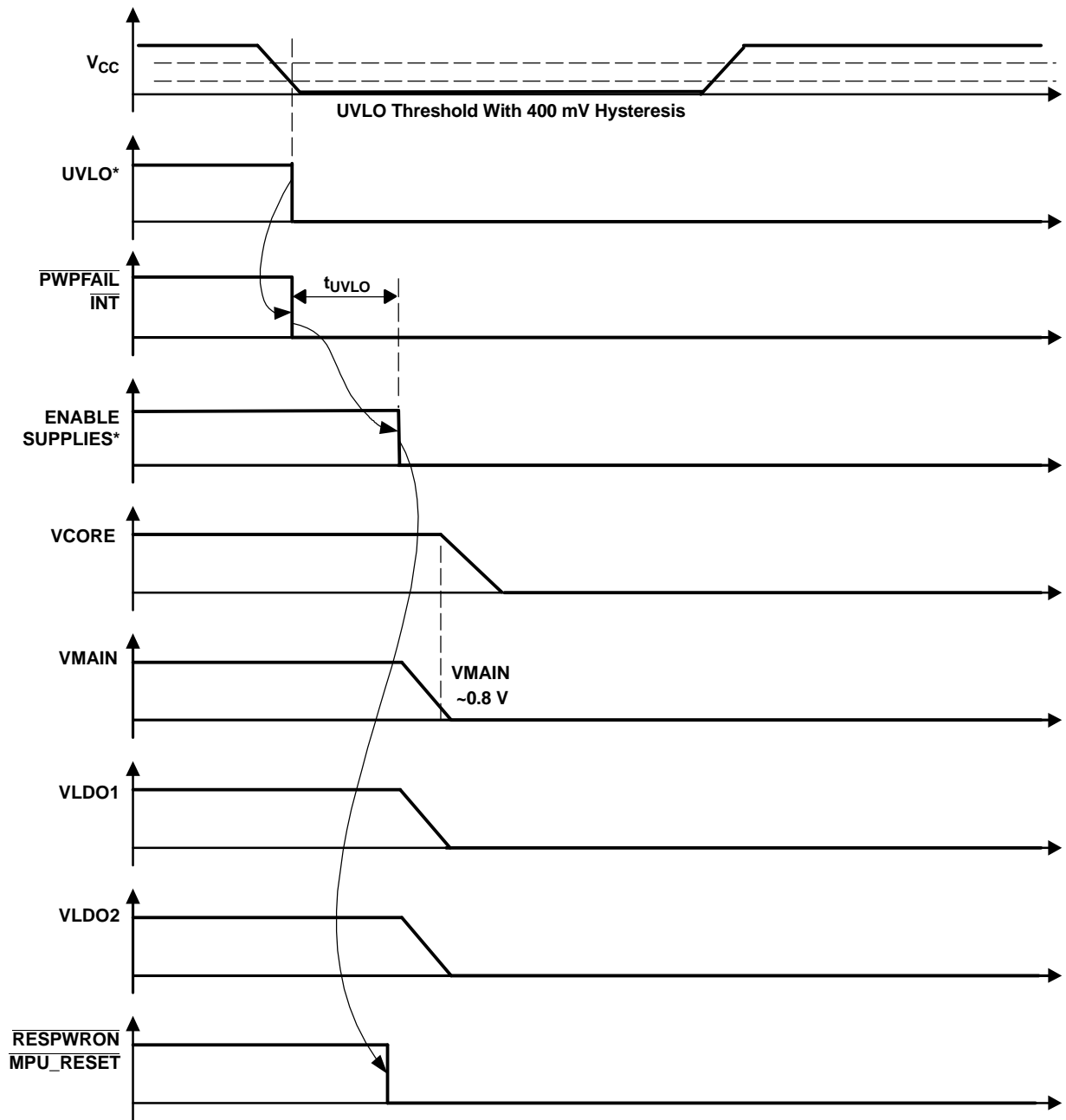

* ... internal signal

Figure 34. State 2 to State 4 Transition

Valid for LDO1 supplied from VMAIN as described earlier in this *Application Section*.

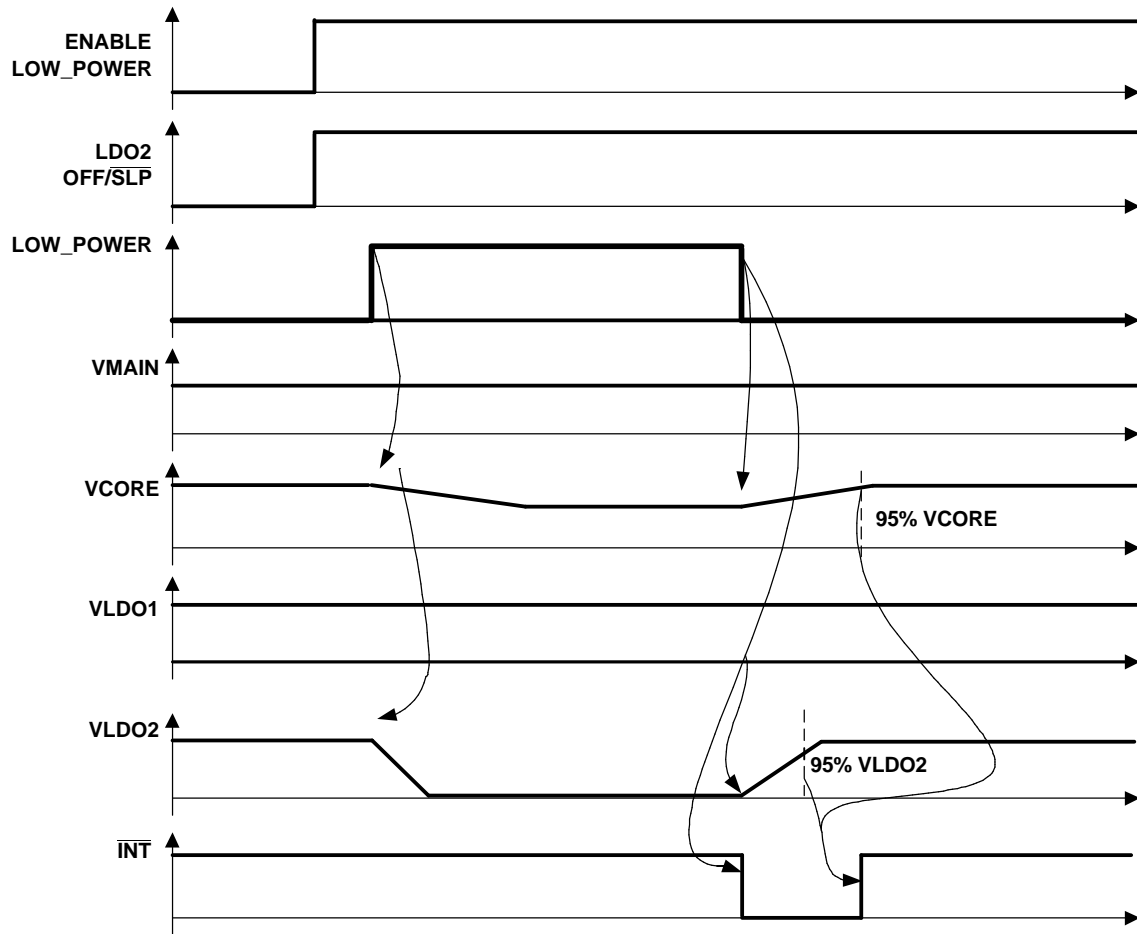

Figure 35. State 2 to State 3 Transition. VCORE Lowered, LDO2 Disabled. Subsequent State 3 to State 2 Transition When LOW POWER Is De-asserted.

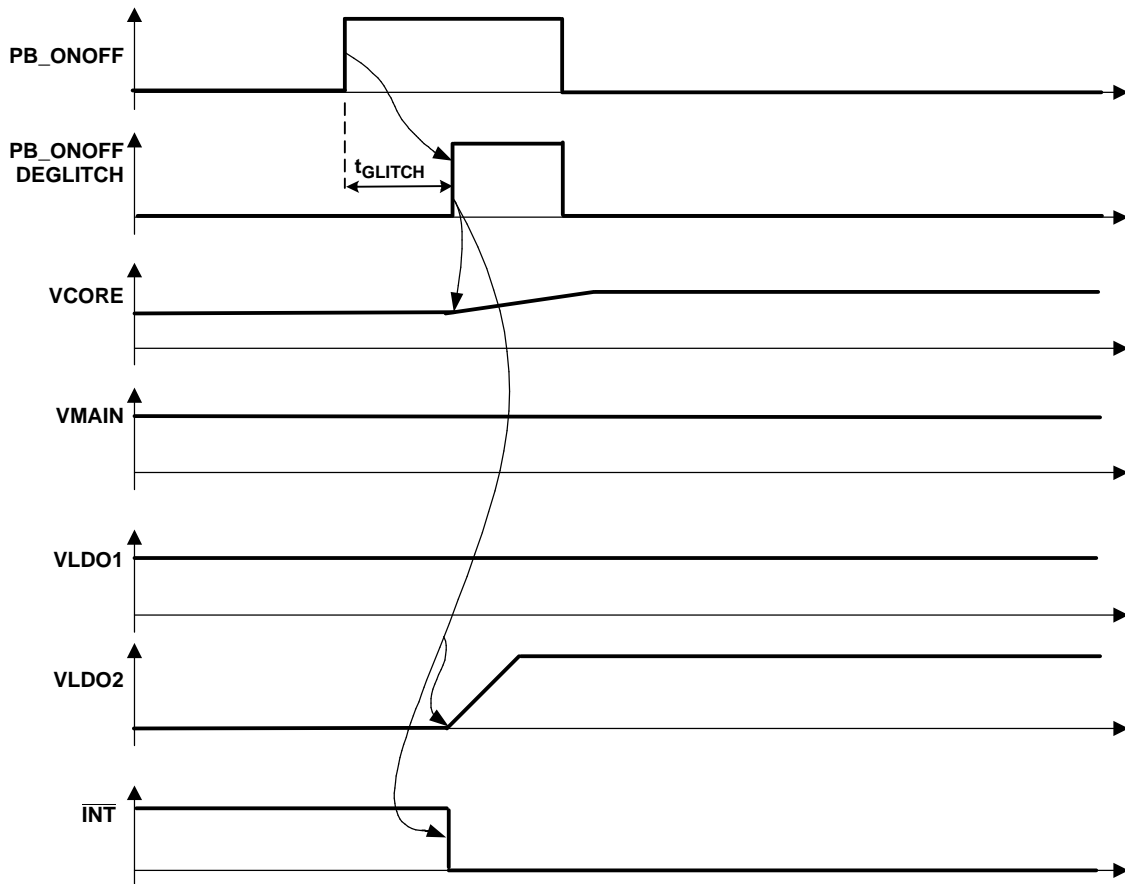

Figure 36. State 3 to State 2 Transition. PB_ONFF Activated (See Interrupt Management Section for $\overline{\text{INT}}$ Behavior)

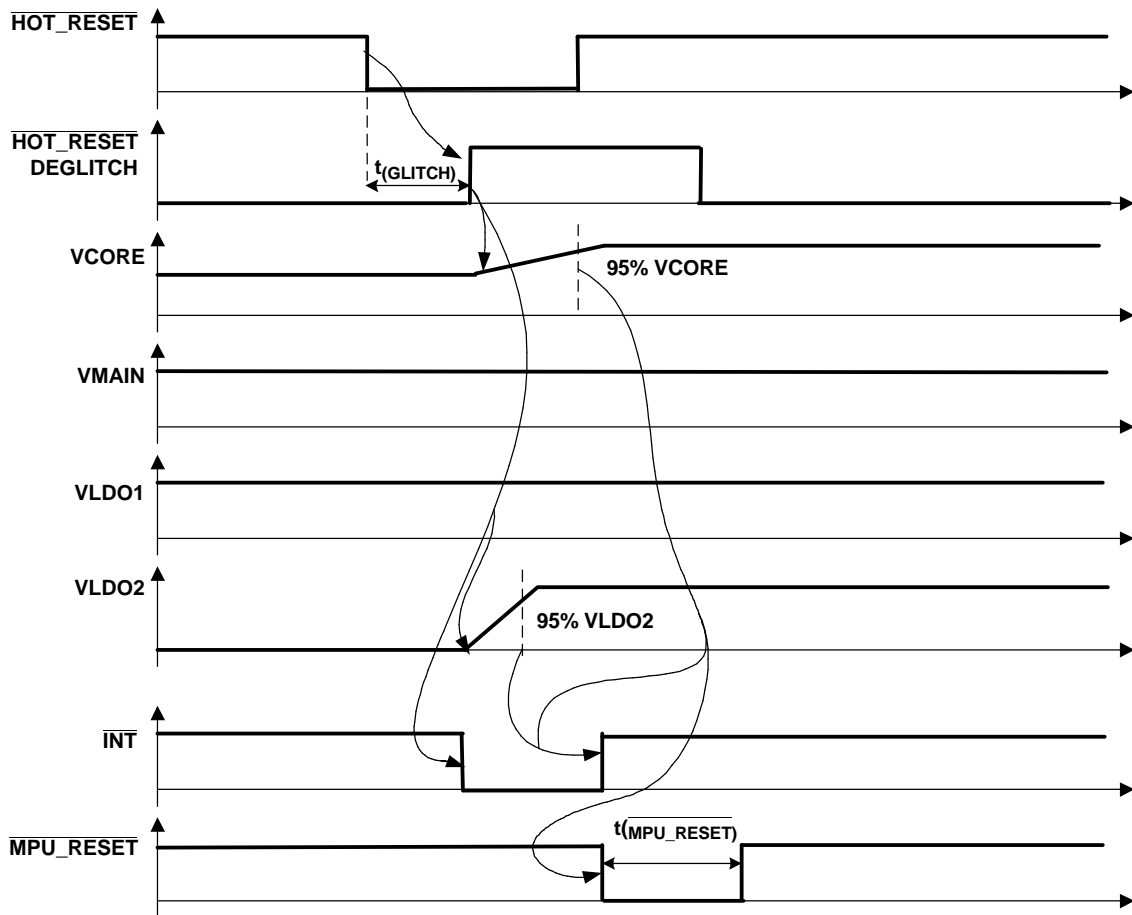

Figure 37. State 3 to State 2 Transition ($\overline{\text{HOT_RESET}}$ Activated, See Interrupt Management Section for $\overline{\text{INT}}$ Behavior)

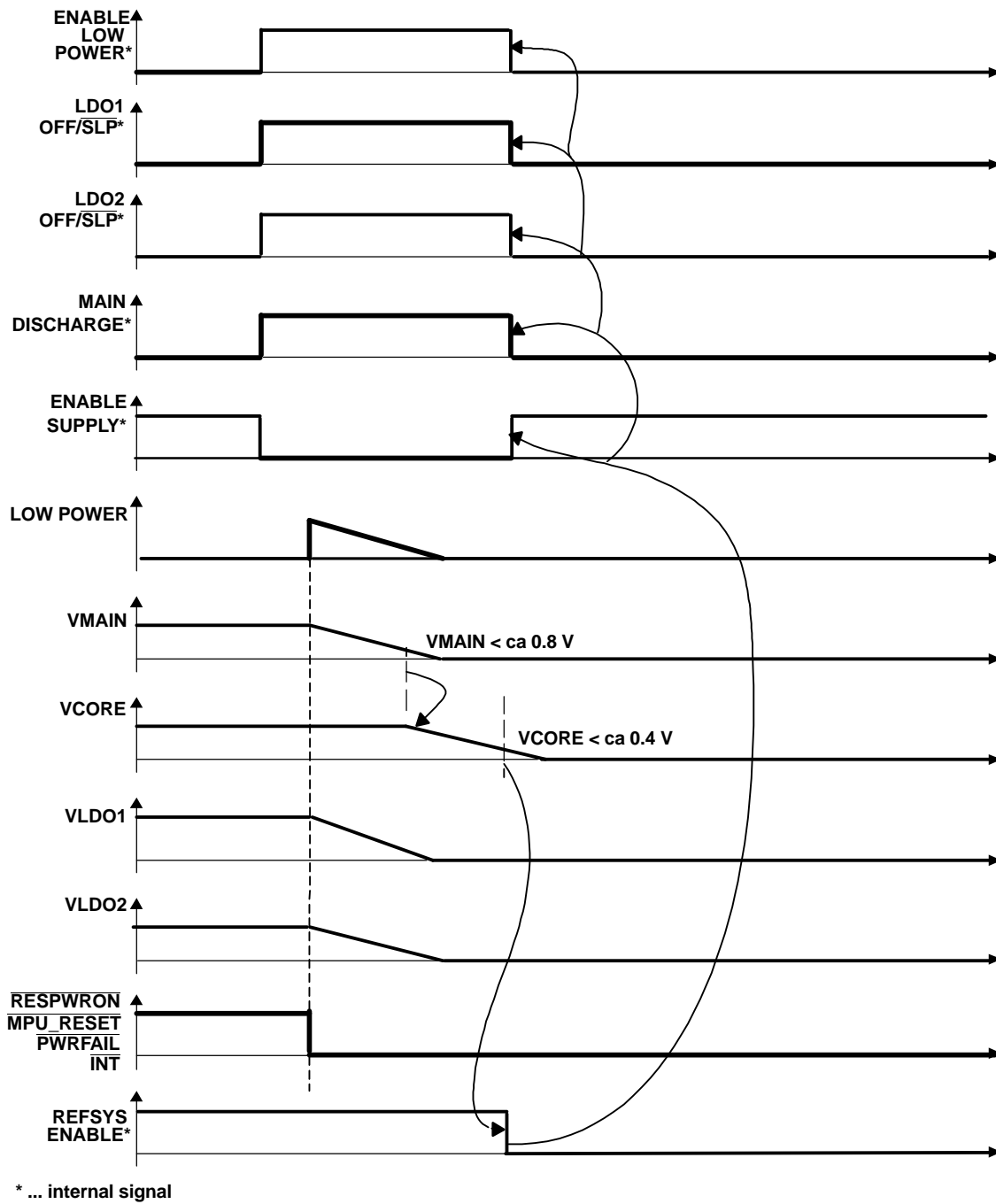

Figure 38. State 1 to State 4 Transition

SYSTEM RESET AND CONTROL SIGNALS

The $\overline{\text{RESPWRON}}$ signal is used as a global reset for the application. It is an open drain-output. The $\overline{\text{RESPWRON}}$ signal is generated according to the power good comparator linked to VMAIN and remains low for $t_{n(\text{RESPWRON})}$ seconds after VMAIN has stabilized. When $\overline{\text{RESPWRON}}$ is low, $\overline{\text{PWRFAIL}}$, $\overline{\text{MPU_RESET}}$ and $\overline{\text{INT}}$ are also held low.

If the output voltage of MAIN is less than 90% of its nominal value, as $\overline{\text{RESPWRON}}$ is generated, and if the output voltage of MAIN is programmed to a higher value, which causes the output voltage to fall out of the 90% window, then a $\overline{\text{RESPWRON}}$ signal is generated.

The $\overline{\text{PWRFAIL}}$ signal indicates when $VCC < UVLO$ or when the TPS65013 junction temperature has exceeded a reliable value or if BATT_COVER is taken low. This open-drain output can be connected as a fast interrupt pin for immediate attention by the application processor. All supplies are disabled $t_{(uvlo)}$, $t_{(overtemp)}$ or $t_{(batt_cover)}$ seconds after $\overline{\text{PWRFAIL}}$ has gone low, giving time for the application processor to shut down cleanly.

BATT_COVER is used to detect whether the battery cover is in place or not. If the battery cover is removed, the TPS65013 generates a warning to the processor that the battery is likely to be removed and that it may be prudent to shut down the system. If not required, this feature may be disabled by connecting the BATT_COVER pin to the VCC pin. BATT_COVER is de-bounced internally. Typical de-bounce time is 56 ms. BATT_COVER has an internal 2-M Ω pulldown resistor.

The $\overline{\text{HOT_RESET}}$ input is used to generate an $\overline{\text{MPU_RESET}}$ signal for the application processor. The $\overline{\text{HOT_RESET}}$ pin could be connected to a user-activated button in the application. It can also be used to exit low-power mode. In this case, the TPS65013 waits until the VCORE voltage has stabilized before generating the $\overline{\text{MPU_RESET}}$ pulse. The $\overline{\text{MPU_RESET}}$ pulse is active low for $t_{(mpu_reset)}$ seconds. $\overline{\text{HOT_RESET}}$ has an internal 1-M Ω pullup resistor to V_{CC} .

The PB_ONOFF input can be used to exit LOW-POWER MODE. It is typically driven by a user-activated push-button in the application. Both $\overline{\text{HOT_RESET}}$ and PB_ONOFF are de-bounced internally by the TPS65013. Typical de-bounce time is 56 ms. PB_ONOFF has an internal 1-M Ω pulldown resistor.

PB_ONOFF, BATT_COVER and UVLO events also cause a normal, maskable interrupt to be generated and are noted in the REGSTATUS register.

VIBRATOR DRIVER

The VIB open-drain output is provided to drive a vibrator motor, controlled via the serial interface register VDCDC2. It has a maximum dropout of 0.5 V at 100-mA load. Typically, an external resistor is required to limit the motor current, and a freewheel diode to limit the VIB overshoot voltage at turnoff.

LED2 OUTPUT

The LED2 output can be programmed in the same way as the $\overline{\text{PG}}$ output to blink or to be permanently on or off. The LED2_ON and LED2_PER registers are used to control the blink rate. For both $\overline{\text{PG}}$ and LED2, the minimum blink-on time is 10 ms, and this can be increased in 127 10-ms steps to 1280 ms. For both $\overline{\text{PG}}$ and LED2, the minimum blink period is 100 ms, and this can be increased in 127 100-ms steps to 12800 ms.

INTERRUPT MANAGEMENT

The open-drain $\overline{\text{INT}}$ pin is used to combine and report all possible conditions via a single pin. Battery and chip temperature faults, precharge timeout, charge timeout, taper timeout, and termination current are each capable of setting $\overline{\text{INT}}$ low, i.e., active. $\overline{\text{INT}}$ can also be activated if any of the regulators are below the regulation threshold. Interrupts can also be generated by any of the GPIO pins programmed to be inputs. These inputs can be programmed to generate an interrupt either at the rising or falling edge of the input signal. It is possible to mask an interrupt from any of these conditions individually by setting the appropriate bits in the MASK1, MASK2, or MASK3 registers. By default, all interrupts are masked. Interrupts are stored in the CHGSTATUS, REGSTATUS, and DEFGPIO registers in the serial interface. CHGSTATUS and REGSTATUS interrupts are acknowledged by reading these registers. If a 1 is present in any location, then the TPS65013 automatically sets the corresponding bit in the ACKINT1 or ACKINT2 registers and releases the $\overline{\text{INT}}$ pin. The ACKINT register contents are self-clearing when the condition, which caused the interrupt, is removed. The applications processor should not normally need to access the ACKINT1 or ACKINT2 registers.

Interrupt events are always captured; thus when an interrupt source is unmasked, $\overline{\text{INT}}$ may immediately go active due to a previous interrupt condition. This can be prevented by first reading the relevant STATUS register before unmasking the interrupt source.

If an interrupt condition occurs, then the $\overline{\text{INT}}$ pin is set low. The CHGSTATUS, REGSTATUS, and DEFGPIO registers should be read. Bit positions containing a 1 (or possibly a 0 in DEFGPIO) are noted by the CPU and the corresponding situation resolved. The reading of the CHGSTATUS and REGSTATUS registers automatically acknowledges any interrupt condition in those registers and blocks the path to the $\overline{\text{INT}}$ pin from the relevant bit(s). No interrupt should be missed during the read process because this process starts by latching the contents of the register before shifting them out at SDAT. Once the contents have been latched (takes a couple of nanoseconds), the register is free to capture new interrupt conditions. Hence, the probability of missing anything is, for practical purposes, zero.

The following describes how registers 0x01 (CHGSTATUS) and 0x02 (REGSTATUS) are handled:

- CHGSTATUS(5,0) are positive edge set. Read of set CHGSTATUS(5,0) bits sets ACKINT1(5,0) bits.
- CHGSTATUS(7-6,4-1) are level set. Read of set CHGSTATUS(7-6,4-1) bits sets ACKINT1(7-6,4-1) bits.
- CHGSTATUS(5,0) clear when input signal low, and ACKINT1(5,0) bits are already set.
- CHGSTATUS(7-6,4-1) clear when input signal is low.
- ACKINT1(7-0) clear when CHGSTATUS(7-0) is clear.
- REGSTATUS(7-5) are positive edge set. Read of set REGSTATUS(7-5) bits sets ACKINT2(7-5) bits.
- REGSTATUS(3-0) are level set. Read of set REGSTATUS(3-0) bits sets ACKINT2(3-0) bits.
- REGSTATUS(7-5) clear when input signal low, and ACKINT1(7-5) bit are already set.
- REGSTATUS(3-0) clear when input signal is low.
- ACKINT2(7-0) clear when REGSTATUS(7-0) is clear.

The following describes the function of the 0x05 (ACKINT1) and 0x06 (ACKINT2) registers. These are not usually written to by the CPU because the TPS65013 internally sets/clears these registers:

- ACKINT1(7:0) - Bit is set when the corresponding CHGSTATUS set bit is read via I²C.
- ACKINT1(7:0) - Bit is cleared when the corresponding CHGSTATUS set bit clears.
- ACKINT2(7:0) - Bit is set when the corresponding REGSTATUS set bit is read via I²C.
- ACKINT2(7:0) - Bit is cleared when the corresponding REGSTATUS set bit clears.
- ACKINT1(7:0) - a bit set masks the corresponding CHGSTATUS bit from $\overline{\text{INT}}$.
- ACKINT2(7:0) - a bit set masks the corresponding REGSTATUS bit from $\overline{\text{INT}}$.

The following describes the function of the 0x03 (MASK1), 0x04 (MASK2) and 0x0F (MASK3) registers:

- MASK1(7:0) - a bit set in this register masks CHGSTATUS from $\overline{\text{INT}}$.
- MASK2(7:0) - a bit set in this register masks REGSTATUS from $\overline{\text{INT}}$.
- MASK3(7:4) - a bit set in this register detects a rising edge on GPIO.
- MASK3(7:4) - a bit cleared in this register detects a falling edge on GPIO.
- MASK3(3:0) - a bit set in this register clears GPIO Detect signal from $\overline{\text{INT}}$.

GPIO interrupts are located by reading the 0x10 (DEFGPIO) register. The application CPU stores, or can read from DEFGPIO<7:4>, which GPIO is set to input or output. This information together with the information on which edge the interrupt was generated (the CPU either knows this or can read it from MASK3<7:4>) determines whether the CPU is looking for a 0 or a 1 in DEFGPIO<3:0>. A GPIO interrupt is blocked from the $\overline{\text{INT}}$ pin by setting the relevant MASK3<3:0> bit; this must be done by the CPU, there is no auto-acknowledge for the GPIO interrupts.

To flag the removal of the charger to the applications processor, a feature is implemented into the TPS65013. As soon as both of the input voltages at AC and USB are removed, the TPS65013 sets the internal bit NO_CH in REGSTATUS<4>=1. If the charger is removed from its supply voltage, this bit can be used to generate an interrupt by setting the mask bit in MASK2<4>=0.

SERIAL INTERFACE

The serial interface is compatible with the standard and fast mode I²C specifications, allowing transfers up to 400 kHz. The interface adds flexibility to the power supply solution, enabling most functions to be programmed to new values depending on the instantaneous application requirements and charger status to be monitored. Register contents remain intact as long as V_{CC} remains above 2 V. The TPS65013 has a 7-bit address with the LSB set by the IFLSB pin; this allows the connection of two devices with the same address to the same bus. The 6 MSBs are 100100. Attempting to read data from register addresses not listed in this section results in FFh being read out.

For normal data transfer, DATA is allowed to change only when CLK is low. Changes when CLK is high are reserved for indicating the start and stop conditions. During data transfer, the data line must remain stable whenever the clock line is high. There is one clock pulse per bit of data. Each data transfer is initiated with a start condition and terminated with a stop condition. When addressed, the TPS65013 device generates an acknowledge bit after the reception of each byte. The master device (microprocessor) must generate an extra clock pulse that is associated with the acknowledge bit. The TPS65013 device must pull down the DATA line during the acknowledge clock pulse so that the DATA line is a stable low during the high period of the acknowledge clock pulse. The DATA line is a stable low during the high period of the acknowledge-related clock pulse. Setup and hold times must be taken into account. During read operations, a master must signal the end of data to the slave by not generating an acknowledge bit on the last byte that was clocked out of the slave. In this case, the slave TPS65013 device must leave the data line high to enable the master to generate the stop condition.

The I²C interface accepts data as soon as the voltage at V_{CC} is higher than the undervoltage lockout threshold and one power rail of the converter (main, core, or one of the LDOs) is operating. Therefore, the I²C interface is not operating after applying the battery voltage as the device automatically enters the WAIT mode with all rails off.

When the device is in WAIT mode, the I²C registers are reset to their default values if all voltage rails are off. If the device is in WAIT mode and one power rail is left on, the I²C interface is operating and the registers are not reset after leaving the WAIT mode.

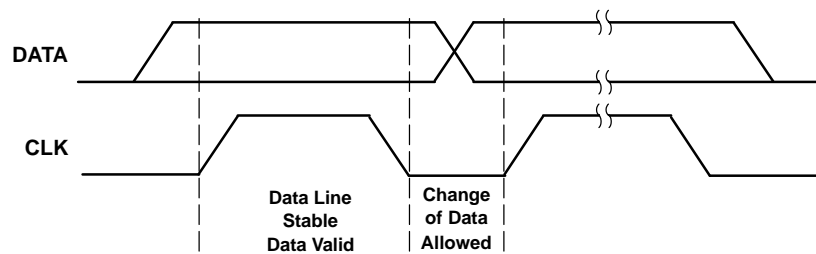

Figure 39. Bit Transfer on the Serial Interface

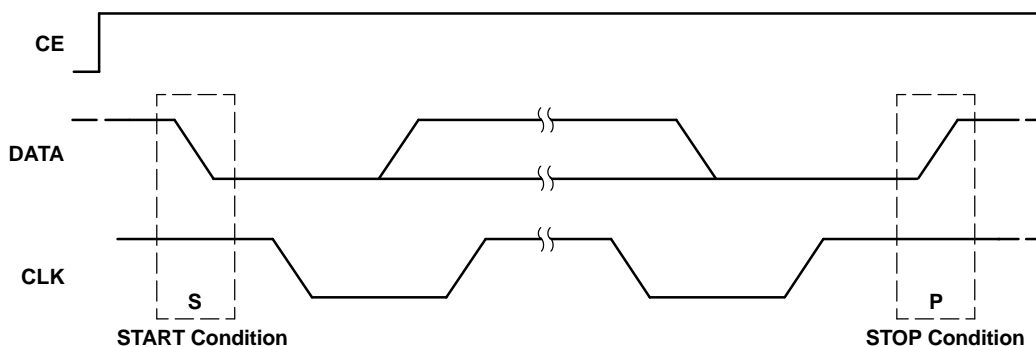

Figure 40. START and STOP Conditions

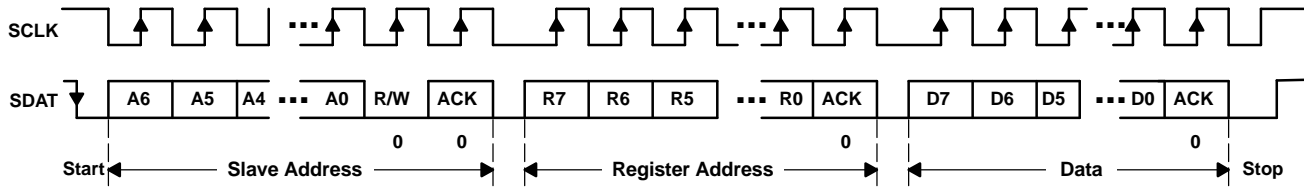

Figure 41. Serial Interface WRITE to TPS65013 Device

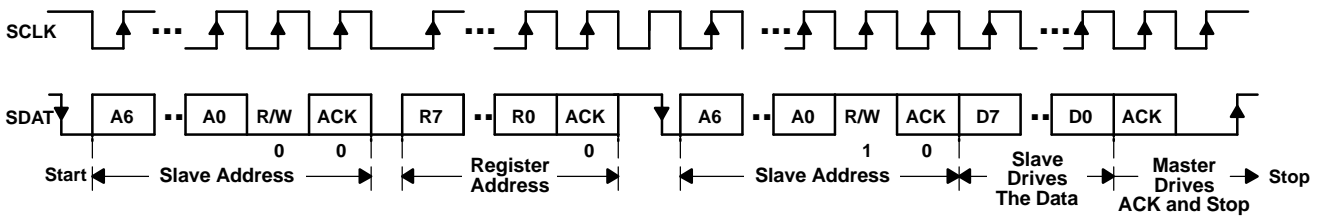

Figure 42. Serial Interface READ From TPS65013: Protocol A

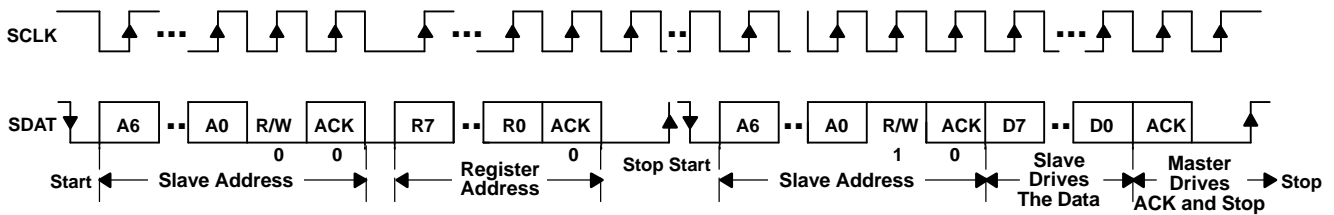

Figure 43. Serial Interface READ From TPS65013: Protocol B

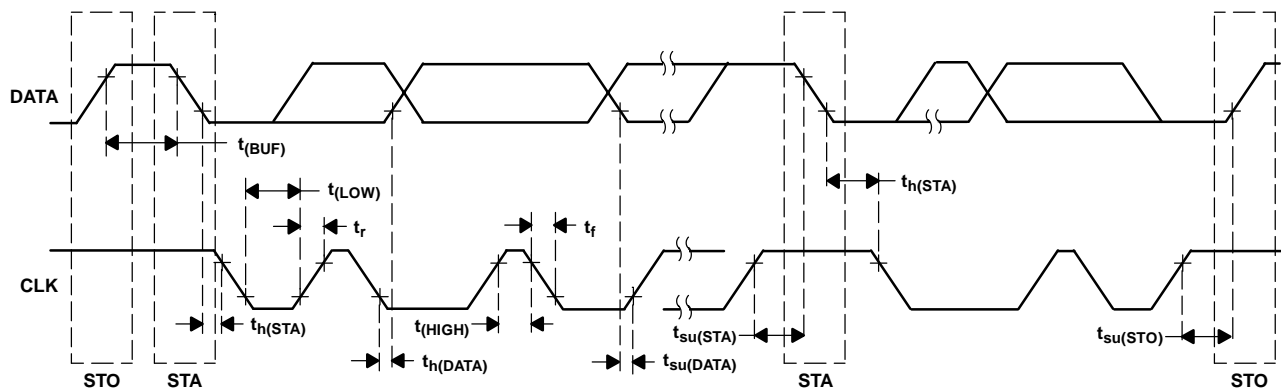

Figure 44. Serial Interface Timing Diagram

CHGSTATUS Register (Address: 01h—Default Value: 00h)

CHGSTATUS	B7	B6	B5	B4	B3	B2	B1	B0
Name	USB charge	AC charge	Thermal Suspend	Term Current	Taper Timeout	Chg Timeout	Prechg Timeout	BattTemp Error
Default	0	0	0	0	0	0	0	0
Read/write	R	R	R	R	R/W	R/W	R/W	R

The CHGSTATUS register contents indicate the status of charge.

Bit 7 - USB charge:

- 0 = inactive.
- 1 = USB source is present and in the range valid for charging. B7 remains active as long as the charge source is present.

Bit 6 - AC charge:

- 0 = wall plug source is not present and/or not in the range valid for charging.
- 1 = wall plug source is present and in the range valid for charging. B6 remains active as long as the charge source is present.

Bit 5 - Thermal suspend:

- 0 = charging is allowed
- 1 = charging is momentarily suspended due to excessive power dissipation on chip.

Bit 4 - Term current:

- 0 = charging, charge termination current threshold has not been crossed.
- 1 = charge termination current threshold has been crossed and charging has been stopped. This can be due to a battery reaching full capacity, or to a battery removal condition.

Bit 3 - 1 Prechg Timeout, Chg Timeout, Taper Timeout:

- If CHCONFIG<5>=0: Bit 3 equals the output of the taper voltage comparator directly, without any timer delay.
- If CHCONFIG<5>=1: there is a delay of 30 minutes because the timers have to time out first.
- 0 = charging, timers did not time out
- 1 = one of the timers has timed out and charging has been terminated.

Bit 0 - BattTemp error: Battery temperature error

- 0 = battery temperature is inside the allowed range and that charging is allowed.
- 1 = battery temperature is outside of the allowed range and that charging is suspended.

B1-4 may be reset via the serial interface in order to force a reset of the charger. Any attempt to write to B0 and B5-7 is ignored. A 1 in B<7:0> sets the $\overline{\text{INT}}$ pin active unless the corresponding bit in the MASK register is set.

REGSTATUS Register (Address: 02h—Default Value: 00h)

REGSTATUS	B7	B6	B5	B4	B3	B2	B1	B0
Bit name	PB_ONOFF	BATT_COVER	UVLO	NO_CH	$\overline{\text{PGOOD}}_{\text{LDO2}}$	$\overline{\text{PGOOD}}_{\text{LDO1}}$	$\overline{\text{PGOOD}}_{\text{MAIN}}$	$\overline{\text{PGOOD}}_{\text{CORE}}$
Default	0	0	0	0	0	0	0	0
Read/write	R	R	R	R	R	R	R	R

Bit 7 - PB_ONOFF:

- 0 = inactive
- 1 = user activated the PB_ONOFF switch to request that all rails are shut down.

Bit 6 - BATT_COVER:

- 0 = BATT_COVER pin is high.
- 1 = BATT_COVER pin is low.

Bit 5 - UVLO:

- 0 = voltage at the VCC pin above UVLO threshold.
- 1 = voltage at the VCC pin has dropped below the UVLO threshold.

Bit 4 - NO_CH:

- 0 = one or more charging sources are present (voltage at AC and/or USB applied).
- 1 = no charging source is present.

Bit 3 - $\overline{\text{PGOOD}}_{\text{LDO2}}$:

- 0 = LDO2 output in regulation, or LDO2 disabled with VREGS1 < 7 > = 0
- 1 = LDO2 output out of regulation.

Bit 2 - $\overline{\text{PGOOD}}_{\text{LDO1}}$:

- 0 = LDO1 output in regulation, or LDO1 disabled with VREGS1 < 3 > = 0
- 1 = LDO1 output out of regulation.

Bit 1 - $\overline{\text{PGOOD}}_{\text{MAIN}}$:

- 0 = Main converter output in regulation.
- 1 = Main converter output out of regulation.

Bit 0 - $\overline{\text{PGOOD}}_{\text{CORE}}$:

- 0 = Core converter output in regulation.
- 1 = Core converter output out of regulation, or VDCDC2 < 7 > = 1 in low-power mode

A rising edge in the REGSTATUS register contents causes $\overline{\text{INT}}$ to be driven low if it is not masked in the MASK2.

MASK1 Register (Address: 03h—Default Value: FFh)

MASK1	B7	B6	B5	B4	B3	B2	B1	B0
Bit name	Mask USB	Mask AC	Mask Thermal Suspend	Mask Term	Mask Taper	Mask Chg	Mask Prechg	Mask BattTemp
Default	1	1	1	1	1	1	1	1
Read/write	R/W	R/W	R/W	R/W	R/W	R/W	R/W	R/W

The MASK1 register is used to mask all or any of the conditions in the corresponding CHGSTATUS<7:0> positions being indicated at the $\overline{\text{INT}}$ pin. Default is to mask all.

MASK2 Register (Address: 04h—Default Value: FFh)

MASK2	B7	B6	B5	B4	B3	B2	B1	B0
Bit name	Mask PB_ONOFF	Mask BATT_COVER	Mask UVLO	NO_CH	Mask PGOOD LDO2	Mask PGOOD LDO1	Mask PGOOD MAIN	Mask PGOOD CORE
Default	1	1	1	1	1	1	1	1
Read/write	R/W	R/W	R/W	R/W	R/W	R/W	R/W	R/W

The MASK2 register is used to mask all or any of the conditions in the corresponding REGSTATUS<7:0> positions being indicated at the $\overline{\text{INT}}$ pin. Default is to mask all.

ACKINT1 Register (Address: 05h—Default Value: 00h)

ACKINT1	B7	B6	B5	B4	B3	B2	B1	B0
Bit name	Ack USB	Ack AC	Ack Thermal Shutdown	Ack Term	Ack Taper	Ack Chg	Ack Prechg	Ack BattTemp
Default	0	0	0	0	0	0	0	0
Read/write	R	R	R	R	R	R	R	R

The ACKINT1 register is internally used to acknowledge any of the interrupts in the corresponding CHGSTATUS<7:0> positions. When this is done, the acknowledged interrupt is no longer fed through to the $\overline{\text{INT}}$ pin and so the $\overline{\text{INT}}$ pin becomes free to indicate the next pending interrupt. If none exists, then the $\overline{\text{INT}}$ pin goes high, else it will remain low. A 1 at any position in ACKINT1 is automatically cleared when the corresponding interrupt condition in CHGSTATUS is removed. The application processor should not normally need to access the ACKINT1 register.

ACKINT2 Register (Address: 06h—Default Value: 00h)

ACKINT2	B7	B6	B5	B4	B3	B2	B1	B0
Bit name	Ack PB_ONOFF	Ack BATT_COVER	Ack UVLO	Ack NO_CH	Ack PGOOD LDO2	Ack PGOOD LDO1	Ack PGOOD MAIN	Ack PGOOD CORE
Default	0	0	0	0	0	0	0	0
Read/write	R	R	R	R	R	R	R	R

The ACKINT2 register is internally used to acknowledge any of the interrupts in the corresponding REGSTATUS<7:0> positions. When this is done, the acknowledged interrupt is no longer fed through to the $\overline{\text{INT}}$ pin and so the $\overline{\text{INT}}$ pin becomes free to indicate the next pending interrupt. If none exists, then the $\overline{\text{INT}}$ pin goes high, else it will remain low. A 1 at any position in ACKINT2 is automatically cleared when the corresponding interrupt condition in REGSTATUS is removed. The application processor should not normally need to access the ACKINT2 register.

CHGCONFIG Register Address: 07h—Default Value: 1Bh

CHGCONFIG	B7	B6	B5	B4	B3	B2	B1	B0
Bit name	AUA	Charger reset	Fast charge timer + taper timer enabled	MSB charge current	LSB charge current	USB / 100 mA 500 mA	USB charge allowed	Charge enable
Default	0	0	0	1	1	0	1	1
Read/write	R/W	R/W	R/W	R/W	R/W	R/W	R/W	R/W

The CHGCONFIG register is used to configure the charger.

Bit 7 - AUA:

- 0 = If a voltage is present at AC or USB in the appropriate range for charging, and if $V_{CC} > UVLO$, the TPS65013 is forced into ON mode. The WAIT mode is disabled.
- 1 = If a voltage source at AC or USB is present, the WAIT mode is enabled, and the TPS65013 does not automatically turn on the converters.

Bit 6 - Charger reset:

- Clears all the timers in the charger and forces a restart of the charge algorithm.
- 0 / 1 = This bit must be set and then reset via the serial interface.

Bit 5 - Fast charge timer + taper timer enabled:

- 0 = fast charge timer disabled (default), CHSTATUS < 3 >= status of the taper detect comparator output.
- 1 = enables the fast charge timer and taper timer. CHSTATUS < 3 >= status of the taper timer.

Bit 4, Bit 3 - MSB/LSB Charge current:

- Used to set the constant current in the current regulation phase.

B4:B3	CHARGE CURRENT RATE
11	Maximum current set by the external resistor at the ISET pin
10	75% of maximum
01	50% of maximum
00	25% of maximum

Bit 2 - USB 100 mA / 500 mA:

- 0 = sets the USB charging current to max 100 mA.
- 1 = sets the USB charging current to max 500 mA. B2 is ignored if B1 = 0.

Bit 1 - USB charge allowed:

- 0 = prevents any charging from the USB input.
- 1 = charging from the USB input is allowed.

Bit 0 - Charge enable:

- 0 = charging is not allowed.
- 1 = charger is free to charge from either of the two input sources. If both sources are present and valid, the TPS65013 charges from the AC pin source.

LED1_ON Register (Address: 08h—Default Value: 00h)

LED1_ON	B7	B6	B5	B4	B3	B2	B1	B0
Bit name	$\overline{PG1}$	LED1 ON6	LED1 ON5	LED1 ON4	LED1 ON3	LED1 ON2	LED1 ON1	LED1 ON0
Default	0	0	0	0	0	0	0	0
Read/write	R/W	R/W	R/W	R/W	R/W	R/W	R/W	R/W

The LED1_ON and LED1_PER registers can be used to take control of the \overline{PG} open-drain output normally controlled by the charger.

Bit 7 - $\overline{PG1}$: Control of the \overline{PG} pin is determined by $\overline{PG1}$ and $\overline{PG2}$ according to the table under LED1_PER register

Bit 6 - BIT 0 - LED1_ON<6:0> are used to program the on-time of the open-drain output transistor at the \overline{PG} pin. The minimum on-time is typically 10 ms and one LSB corresponds to a 10-ms step change in the on-time.

LED1_PER Register (Address: 09h—Default Value: 00h)

LED1_PER	B7	B6	B5	B4	B3	B2	B1	B0
Bit name	$\overline{PG2}$	LED1 PER6	LED1 PER5	LED1 PER4	LED1 PER3	LED1 PER2	LED1 PER1	LED1 PER0
Default	0	0	0	0	0	0	0	0
Read/write	R/W	R/W	R/W	R/W	R/W	R/W	R/W	R/W

Bit 7 - $\overline{PG2}$: Control of the \overline{PG} pin is determined by $\overline{PG1}$ and $\overline{PG2}$ according to the following table. Default shown in **bold**.

$\overline{PG1}$	$\overline{PG2}$	BEHAVIOR OF \overline{PG} OPEN-DRAIN OUTPUT
0	0	Under charger control
0	1	Blink
1	0	Off
1	1	Always On

Bit 6-Bit 0 - LED1_PER<6:0> are used to program the time period of the open-drain output transistor at the \overline{PG} pin. The minimum period is typically 100 ms and one LSB corresponds to a 100-ms step change in the period.

LED2_ON Register (Address: 0Ah—Default Value: 00h)

LED2_ON	B7	B6	B5	B4	B3	B2	B1	B0
Bit name	LED21	LED2 ON6	LED2 ON5	LED2 ON4	LED2 ON3	LED2 ON2	LED2 ON1	LED2 ON0
Default	0	0	0	0	0	0	0	0
Read/write	R/W	R/W	R/W	R/W	R/W	R/W	R/W	R/W

The LED2_ON and LED2_PER registers are used to control the LED2 open-drain output.

Bit 7 LED22: Control is determined by LED21 and LED22 according to the table under LED2_PER register.

Bit 6-Bit 0 - LED2_ON<6:0> are used to program the on-time of the open-drain output transistor at the LED2 pin. The minimum on-time is typically 10 ms and one LSB corresponds to a 10-ms step change in the on-time.

LED2_PER (Register Address: 0Bh—Default Value: 00h)

LED2_PER	B7	B6	B5	B4	B3	B2	B1	B0
Bit name	LED22	LED2 PER6	LED2 PER5	LED2 PER4	LED2 PER3	LED2 PER2	LED2 PER1	LED2 PER 0
Default	0	0	0	0	0	0	0	0
Read/write	R/W	R/W	R/W	R/W	R/W	R/W	R/W	R/W

Bit 7 LED22: Control is determined by LED21 and LED22 according to the table. Default shown in **bold**.

Bit 6-Bit 0 - LED2_ON<6:0> are used to program the on-time of the open-drain output transistor at the LED2 pin. The minimum on-time is typically 100 ms and one LSB corresponds to a 100-ms step change in the on-time.

LED21	LED22	BEHAVIOR OF LED2 OPEN-DRAIN OUTPUT
0	0	Off
0	1	Blink
1	0	Off
1	1	Always On

VDCDC1 Register (Address: 0Ch—Default Value: 32h/33h)

VDCDC1	B7	B6	B5	B4	B3	B2	B1	B0
Bit name	FPWM	UVLO1	UVLO0	ENABLE SUPPLY	ENABLE LP	MAIN DIS-CHARGE	MAIN1	MAIN0
Default	0	0	1	1	0	0	1	DEFMAIN
Read/write	R/W	R/W	R/W	R/W	R/W	R/W	R/W	R/W

The VDCDC1 register is used to program the VMAIN switching converter.

Bit 7 - FPWM: forced PWM mode for dc-dc converters.

- 0 = MAIN and the CORE dc-dc converter are allowed to switch into PFM mode.
- 1 = MAIN and the CORE dc-dc converter operate with forced fixed frequency PWM mode and are not allowed to switch into PFM mode, at light load.

Bit 6-Bit 5 - UVLO<1:0>: The undervoltage threshold voltage is set by UVLO1 and UVLO0 according to the following table, with the default value in **bold**.

UVLO1	UVLO0	V _{UVLO}
0	0	2.5 V
0	1	2.75 V
1	0	3.0 V
1	1	3.25 V

Bit 4 - ENABLE SUPPLY (selects between LOW-POWER mode and WAIT mode):

- 0 = WAIT mode allowed, activated when LOW_PWR pin = 1 and VDCDC1 < 3 >= 1.
- 1 = The TPS65013 enters LOW-POWER mode when LOW_PWR pin = 1 and VDCDC1 < 3 >= 1.

Bit 3 - ENABLE LP:

- 0 = disables the low-power function of the LOW_PWR pin.
- 1 = enables the low-power function of the LOW_PWR pin.

Bit 2 - MAIN DISCHARGE:

- 0 = disable the active discharge of the VMAIN converter output.
- 1 = enable the active discharge of the VMAIN converter output, when the converter is disabled (i.e., in WAIT mode).

Bit 1-Bit 0 - MAIN<1:0>: The VMAIN converter output voltages are set according to the following table, with the default values in bold set by the DEFMAIN pin. The default voltage can subsequently be over written via the serial interface after start-up.

MAIN1	MAIN0	VMAIN
0	0	3.0 V
0	1	2.75 V
1	0	1.8 V
1	1	3.3 V

VDCDC2 Register (Address: 0Dh—Default Value: 48h/78h)

VDCDC2	B7	B6	B5	B4	B3	B2	B1	B0
Bit name	LP_COREOFF	CORE2	CORE1	CORE0	CORELP0	CORELP1	VIB	CORE DISCHARGE
Default	0	1	DEFCORE	DEFCORE	1	0	0	0
Read/write	R/W	R/W	R/W	R/W	R/W	R/W	R/W	R/W

The VDCDC2 register is used to program the VCORE switching converter output voltage. It is programmable in 8 steps between 0.85 V and 1.6 V. The default value is governed by the DEFCORE pin; DEFCORE=0 sets an output voltage of 1.3 V. DEFCORE=1 sets an output voltage of 1.6 V.

Bit 7 - LP_COREOFF:

- 0 = VCORE converter is enabled in low-power mode.
- 1 = VCORE converter is disabled in low-power mode.

Bit 6-Bit 4 - CORE<2:0>: The following table shows all possible values of V_{CORE}. The default value can subsequently be overwritten via the serial interface after start-up.

CORE2	CORE1	CORE0	V _{CORE}
0	0	0	0.85 V
0	0	1	1.05 V
0	1	0	1.1 V
0	1	1	1.2 V
1	0	0	1.3 V
1	0	1	1.4 V
1	1	0	1.5 V
1	1	1	1.6 V

Bit 3-Bit 2 - CORELP<1:0>: CORELP1, and CORELP0 can be used to set the V_{CORE} voltage in low-power mode. In low-power mode, CORE2 is effectively 0, and CORE1, CORE0 take on the values programmed at CORELP1 and CORELP0, default 01 giving V_{CORE} = 1.05 V as default in low-power mode. When low-power mode is exited, V_{CORE} reverts to the value set by CORE2, CORE1, and CORE0.

Bit 1 - VIB:

- 0 = disables the VIB output transistor.
- 1 = enables the VIB output transistor to drive the vibrator motor.

Bit 0 - CORE DISCHARGE:

- 0 = disables the active discharge of the V_{CORE} converter output.
- 1 = enables the active discharge of the V_{CORE} converter output in WAIT mode, or if V_{DCDC2} < 7 >= 1 in LOW-POWER mode.

VREGS1 Register (Address: 0Eh—Default Value: 88h)

VREGS1	B7	B6	B5	B4	B3	B2	B1	B0
Bit name	LDO2 enable	LDO2 OFF / nSLP	LDO21	LDO20	LDO1 enable	LDO1 OFF / nSLP	LDO11	LDO10
Default	1	0	0	0	1	0	0	0
Read/write	R/W	R/W	R/W	R/W	R/W	R/W	R/W	R/W

The VREGS1 register is used to program and enable LDO1 and LDO2 and to set their behavior when low-power mode is active. The LDO output voltages can be set either on the fly, while the relevant LDO is disabled, or simultaneously when the relevant enable bit is set. Note that both LDOs are per default ON.

Bit 7-Bit 6 - The function of the LDO2 enable and LDO2 OFF/nSLP bits is shown in the following table. See the power-on sequencing section for details of low-power mode.

LDO2 ENABLE	LDO2 OFF / nSLP	LDO STATUS IN NORMAL MODE	LDO STATUS IN LOW-POWER MODE
0	X	OFF	OFF
1	0	ON, full power	ON, reduced power / performance
1	1	ON, full power	OFF

Bit 5-Bit 4 - LDO2<1:0>: LDO2 has a default output voltage of 1.8 V. If so desired, this can be changed at the same time as it is enabled via the serial interface.

LDO21	LDO20	V _{LDO2}
0	0	1.8 V
0	1	2.5 V
1	0	3.0 V
1	1	3.3 V

Bit 3-Bit 2 - The function of the LDO1 enable and LDO1 OFF / nSLP bits is shown in the following table. See the power-on sequencing section for details of low-power mode. Note that programming LDO1 to a higher voltage may force a system power-on reset if the increase is in the 10% or greater range.

LDO1 ENABLE	LDO1 OFF / nSLP	LDO STATUS IN NORMAL MODE	LDO STATUS IN LOW-POWER MODE
0	X	OFF	OFF
1	0	ON, full power	ON, reduced power / performance
1	1	ON, full power	OFF

Bit 1-Bit 0 - LDO1<1:0>: The LDO1 output voltage is per default set externally. If so desired, this can be changed via the serial interface.

LDO11	LDO10	VLDO1
0	0	ADJ
0	1	2.5 V
1	0	2.75 V
1	1	3.0 V

MASK3 Register (Address: 0Fh—Default Value: 00h)

MASK3	B7	B6	B5	B4	B3	B2	B1	B0
Bit name	Edge trigger GPIO4	Edge trigger GPIO3	Edge trigger GPIO2	Edge trigger GPIO1	Mask GPIO4	Mask GPIO3	Mask GPIO2	Mask GPIO1
Default	0	0	0	0	0	0	0	0
Read/write	R/W	R/W	R/W	R/W	R/W	R/W	R/W	R/W

The MASK3 register must be considered when any of the GPIO pins are programmed as inputs.

Bit 7-Bit 4 - Edge trigger GPIO<4:1>: determine whether the respective GPIO generates an interrupt at a rising or a falling edge.

- 0 = falling edge triggered.
- 1 = rising edge triggered.

Bit 3-Bit 0 - Mask GPIO<4:1>: can be used to mask the corresponding interrupt. Default is unmasked (mask GPIOx = 0).

DEFGPIO Register Address: (10h—Default Value: 00h)

DEFGPIO	B7	B6	B5	B4	B3	B2	B1	B0
Bit name	IO4	IO3	IO2	IO1	Value GPIO4	Value GPIO3	Value GPIO2	Value GPIO1
Default	0	0	0	0	0	0	0	0
Read/write	R/W	R/W	R/W	R/W	R/W	R/W	R/W	R/W

The DEFGPIO register is used to define the GPIO pins to be either input or output.

Bit 7-Bit 4 - IO<4:1>:

- 0 = sets the corresponding GPIO to be an input.
- 1 = sets the corresponding GPIO to be an output.

Bit 3-Bit 0 - Value GPIO<4:1>: If a GPIO is programmed to be an output, then the signal output is determined by the corresponding bit. The output circuit for each GPIO is an open-drain NMOS requiring an external pullup resistor.

- 1 = activates the relevant NMOS, hence forcing a logic low signal at the GPIO pin.
- 0 = turns the open-drain transistor OFF, hence the voltage at the GPIO pin is determined by the voltage to which the pullup resistor is connected.

If a particular GPIO is programmed to be an input, then the contents of the relevant bit in B3-0 is defined by the logic level at the GPIO pin. A logic low forces a 0 and a logic high forces a 1. If a GPIO is programmed to be an input, then any attempt to write to the relevant bit in B3-0 is ignored.

DESIGN PROCEDURE

Inductor Selection for the Main and the Core Converter

The main and the core converters in the TPS65013 typically use a 6.2- μH and a 10- μH output inductor, respectively. Larger or smaller inductor values can be used to optimize the performance of the device for specific operation conditions. The selected inductor has to be rated for its dc resistance and saturation current. The dc resistance of the inductance directly influences the efficiency of the converter. Therefore, an inductor with lowest dc resistance is selected for highest efficiency.

Equation 3 calculates the maximum inductor current under static load conditions. The saturation current of the inductor should be rated higher than the maximum inductor current as calculated with Equation 3. This is needed because during heavy load transient, the inductor current rises above the value calculated under Equation 3.

$$\Delta I_L + V_O \times \frac{1 - \frac{V_O}{V_I}}{L \times f} \quad (3)$$

$$I_{L(\max)} + I_{O(\max)} \times \frac{\Delta I_L}{2} \quad (4)$$

with:

- f = Switching frequency (1.25 MHz typical)
- L = Inductor value
- ΔI_L = Peak-to-peak inductor ripple current
- $I_{L\max}$ = Maximum inductor current

The highest inductor current occurs at maximum V_I .

Open core inductors have a soft saturation characteristic, and they can usually handle higher inductor currents versus a comparable shielded inductor.

A more conservative approach is to select the inductor current rating just for the maximum switch current of the TPS65013 (2 A for the main converter and 0.8 A for the core converter). Keep in mind that the core material from inductor to inductor differs and has an impact on the efficiency especially at high switching frequencies.

Refer to Table 4 and the typical applications for possible inductors

Table 4. Tested Inductors

DEVICE	INDUCTOR VALUE	DIMENSIONS	COMPONENT SUPPLIER
Core converter	10 μH	6,0 mm \times 6,0 mm \times 2,0 mm	Sumida CDRH5D18-100
	10 μH	5,0 mm \times 5,0 mm \times 3,0 mm	Sumida CDRH4D28-100
Main converter	4.7 μH	5,5 mm \times 6,6 mm \times 1,0 mm	Coilcraft LPO1704-472M
	4.7 μH	5,0 mm \times 5,0 mm \times 3,0 mm	Sumida CDRH4D28C-4.7
	4.7 μH	5,2 mm \times 5,2 mm \times 2,5 mm	Coiltronics SD25-4R7
	5.3 μH	5,7 mm \times 5,7 mm \times 3,0 mm	Sumida CDRH5D28-5R3
	6.2 μH	5,7 mm \times 5,7 mm \times 3,0 mm	Sumida CDRH5D28-6R2
	6.0 μH	7,0 mm \times 7,0 mm \times 3,0 mm	Sumida CDRH6D28-6R0

Output Capacitor Selection

The advanced fast response voltage mode control scheme of the inductive converters implemented in the TPS65013 allow the use of small ceramic capacitors with a typical value of 22 μF for the main converter and 10 μF for the core converter without having large output voltage under and overshoots during heavy load transients. Ceramic capacitors having low ESR values have the lowest output voltage ripple and are recommended. If required, tantalum capacitors with an ESR $<$ 100 Ω may be used as well.

Refer to Table 5 for recommended components.

If ceramic output capacitors are used, the capacitor RMS ripple current rating always meets the application requirements. Just for completeness the RMS ripple current is calculated as:

$$I_{\text{RMSC(out)}} + V_O \times \frac{1 - \frac{V_O}{V_I}}{L \times f} \times \frac{1}{2 \times \sqrt{3}} \tag{5}$$

At nominal load current, the inductive converters operate in PWM mode and the overall output voltage ripple is the sum of the voltage spike caused by the output capacitor ESR plus the voltage ripple caused by charging and discharging the output capacitor:

$$\Delta V_O \approx V_O \times \frac{1 - \frac{V_O}{V_I}}{L \times f} \times \left(\frac{1}{8 \times C_O \times f} + \text{ESR} \right) \tag{6}$$

Where the highest output voltage ripple occurs at the highest input voltage V_I .

At light load currents, the converters operate in power-save mode and the output voltage ripple is independent of the output capacitor value. The output voltage ripple is set by the internal comparator thresholds. The typical output voltage ripple is 1% of the nominal output voltage. If the output voltage for the core converter is programmed to its lowest voltage of 0.85 V, the output capacitor must be increased to 22 μF for low output voltage ripple. This is because the current in the inductor decreases slowly during the off-time and further increases the output voltage even when the PMOS is off. This effect increases with low output voltages.

Input Capacitor Selection

A pulsating input current is the nature of the buck converter. Therefore, a low ESR input capacitor is required for best input voltage filtering. It also minimizes the interference with other circuits caused by high input voltage spikes. The main converter needs a 22- μF ceramic input capacitor and the core converter a 10- μF ceramic capacitor. The input capacitor for the main and the core converter can be combined and one 22- μF capacitor can be used instead, because the two converters operate with a phase shift of 270 degrees. The input capacitor can be increased without any limit for better input voltage filtering. The VCC pin should be separated from the input for the main and the core converter. A filter resistor of up to 100 Ω and a 1- μF capacitor is used for decoupling the VCC pin from switching noise.

Table 5. Possible Capacitors

CAPACITOR VALUE	CASE SIZE	COMPONENT SUPPLIER	COMMENTS
22 μF	1206	TDK C3216X5R0J226M	Ceramic
22 μF	1206	Taiyo Yuden JMK316BJ226ML	Ceramic
22 μF	1210	Taiyo Yuden JMK325BJ226MM	Ceramic

LDO1

Output Voltage Adjustment

The output voltage of LDO1 is set with a resistor divider at the feedback pin. The sum of the two resistors must not exceed 1 M Ω to minimize voltage changes due to leakage current into the feedback pin. The output voltage for LDO1 after start-up is the voltage set by the external resistor divider. It can be reprogrammed with the I²C interface to the three other values defined in the register VREGS1.

THERMAL INFORMATION

This package incorporates an exposed thermal pad that is designed to be attached directly to an external heatsink. The thermal pad must be soldered directly to the printed circuit board (PCB), the PCB can be used as a heatsink. In addition, through the use of thermal vias, the thermal pad can be attached directly to a ground plane or special heatsink structure designed into the PCB. This design optimizes the heat transfer from the integrated circuit (IC).

For information on the Quad Flatpack No-Lead (QFN) package and its advantages, refer to Application Report, Quad Flatpack No-Lead Logic Packages, Texas Instruments Literature No. SCBA017. This document is available at www.ti.com.

The exposed thermal pad dimensions for this package are shown in the following illustration.

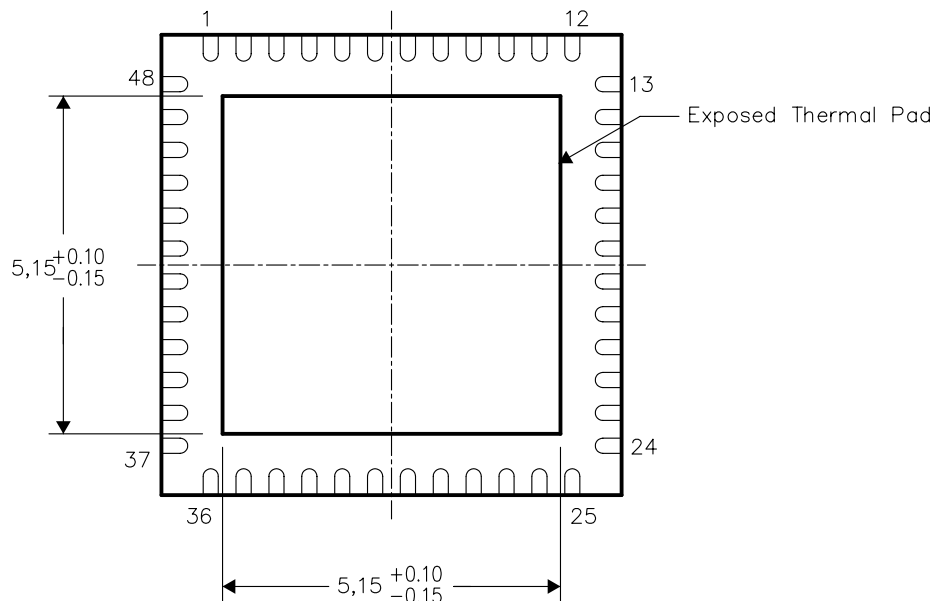

Bottom View

NOTE: All linear dimensions are in millimeters

Exposed Thermal Pad Dimensions

PACKAGING INFORMATION

Orderable Device	Status ⁽¹⁾	Package Type	Package Drawing	Pins	Package Qty	Eco Plan ⁽²⁾	Lead/Ball Finish	MSL Peak Temp ⁽³⁾
TPS65013RGZR	ACTIVE	VQFN	RGZ	48	2500	Green (RoHS & no Sb/Br)	CU NIPDAU	Level-2-260C-1 YEAR
TPS65013RGZRG4	ACTIVE	VQFN	RGZ	48	2500	Green (RoHS & no Sb/Br)	CU NIPDAU	Level-2-260C-1 YEAR
TPS65013RGZT	ACTIVE	VQFN	RGZ	48	250	Green (RoHS & no Sb/Br)	CU NIPDAU	Level-2-260C-1 YEAR
TPS65013RGZTG4	ACTIVE	VQFN	RGZ	48	250	Green (RoHS & no Sb/Br)	CU NIPDAU	Level-2-260C-1 YEAR

⁽¹⁾ The marketing status values are defined as follows:

ACTIVE: Product device recommended for new designs.

LIFEBUY: TI has announced that the device will be discontinued, and a lifetime-buy period is in effect.

NRND: Not recommended for new designs. Device is in production to support existing customers, but TI does not recommend using this part in a new design.

PREVIEW: Device has been announced but is not in production. Samples may or may not be available.

OBSOLETE: TI has discontinued the production of the device.

⁽²⁾ Eco Plan - The planned eco-friendly classification: Pb-Free (RoHS), Pb-Free (RoHS Exempt), or Green (RoHS & no Sb/Br) - please check <http://www.ti.com/productcontent> for the latest availability information and additional product content details.

TBD: The Pb-Free/Green conversion plan has not been defined.

Pb-Free (RoHS): TI's terms "Lead-Free" or "Pb-Free" mean semiconductor products that are compatible with the current RoHS requirements for all 6 substances, including the requirement that lead not exceed 0.1% by weight in homogeneous materials. Where designed to be soldered at high temperatures, TI Pb-Free products are suitable for use in specified lead-free processes.

Pb-Free (RoHS Exempt): This component has a RoHS exemption for either 1) lead-based flip-chip solder bumps used between the die and package, or 2) lead-based die adhesive used between the die and leadframe. The component is otherwise considered Pb-Free (RoHS compatible) as defined above.

Green (RoHS & no Sb/Br): TI defines "Green" to mean Pb-Free (RoHS compatible), and free of Bromine (Br) and Antimony (Sb) based flame retardants (Br or Sb do not exceed 0.1% by weight in homogeneous material)

⁽³⁾ MSL, Peak Temp. -- The Moisture Sensitivity Level rating according to the JEDEC industry standard classifications, and peak solder temperature.

Important Information and Disclaimer:The information provided on this page represents TI's knowledge and belief as of the date that it is provided. TI bases its knowledge and belief on information provided by third parties, and makes no representation or warranty as to the accuracy of such information. Efforts are underway to better integrate information from third parties. TI has taken and continues to take reasonable steps to provide representative and accurate information but may not have conducted destructive testing or chemical analysis on incoming materials and chemicals. TI and TI suppliers consider certain information to be proprietary, and thus CAS numbers and other limited information may not be available for release.

In no event shall TI's liability arising out of such information exceed the total purchase price of the TI part(s) at issue in this document sold by TI to Customer on an annual basis.

TAPE AND REEL INFORMATION

QUADRANT ASSIGNMENTS FOR PIN 1 ORIENTATION IN TAPE

*All dimensions are nominal

Device	Package Type	Package Drawing	Pins	SPQ	Reel Diameter (mm)	Reel Width W1 (mm)	A0 (mm)	B0 (mm)	K0 (mm)	P1 (mm)	W (mm)	Pin1 Quadrant
TPS65013RGZR	VQFN	RGZ	48	2500	330.0	16.4	7.3	7.3	1.5	12.0	16.0	Q2
TPS65013RGZT	VQFN	RGZ	48	250	330.0	16.4	7.3	7.3	1.5	12.0	16.0	Q2

TAPE AND REEL BOX DIMENSIONS



*All dimensions are nominal

Device	Package Type	Package Drawing	Pins	SPQ	Length (mm)	Width (mm)	Height (mm)
TPS65013RGZR	VQFN	RGZ	48	2500	333.2	345.9	28.6
TPS65013RGZT	VQFN	RGZ	48	250	333.2	345.9	28.6

RGZ (S-PQFP-N48)

PLASTIC QUAD FLATPACK

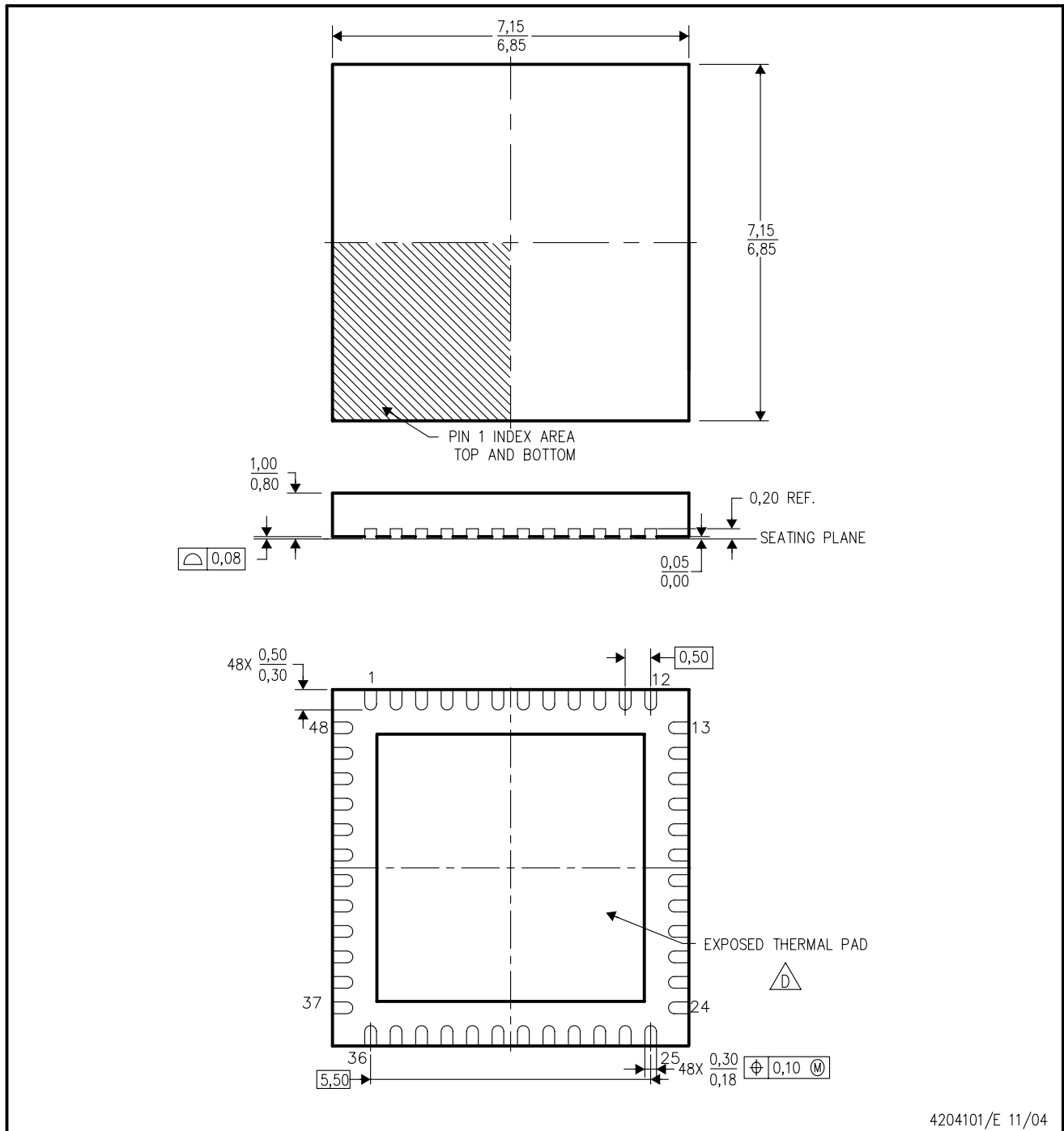

4204101/E 11/04

- NOTES:
- A. All linear dimensions are in millimeters. Dimensioning and tolerancing per ASME Y14.5M-1994.
 - B. This drawing is subject to change without notice.
 - C. Quad Flatpack, No-leads (QFN) package configuration.
 - D. The package thermal pad must be soldered to the board for thermal and mechanical performance. See the Product Data Sheet for details regarding the exposed thermal pad dimensions.
 - E. Falls within JEDEC MO-220.

THERMAL PAD MECHANICAL DATA

RGZ (S-PVQFN-N48)

PLASTIC QUAD FLATPACK NO-LEAD

THERMAL INFORMATION

This package incorporates an exposed thermal pad that is designed to be attached directly to an external heatsink. The thermal pad must be soldered directly to the printed circuit board (PCB). After soldering, the PCB can be used as a heatsink. In addition, through the use of thermal vias, the thermal pad can be attached directly to the appropriate copper plane shown in the electrical schematic for the device, or alternatively, can be attached to a special heatsink structure designed into the PCB. This design optimizes the heat transfer from the integrated circuit (IC).

For information on the Quad Flatpack No-Lead (QFN) package and its advantages, refer to Application Report, QFN/SON PCB Attachment, Texas Instruments Literature No. SLUA271. This document is available at www.ti.com.

The exposed thermal pad dimensions for this package are shown in the following illustration.

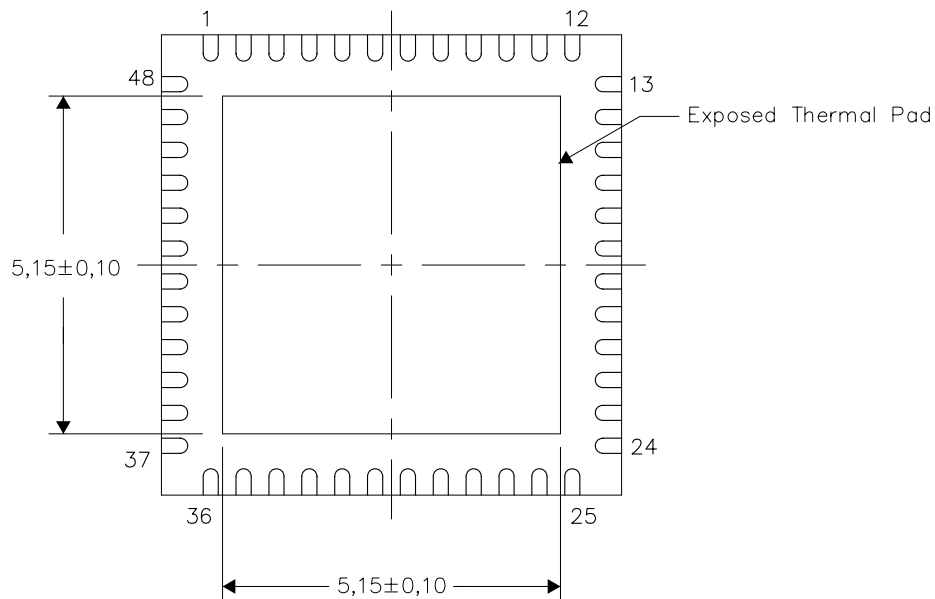

Bottom View

NOTE: All linear dimensions are in millimeters

Exposed Thermal Pad Dimensions

4206354-2/M 06/10

IMPORTANT NOTICE

Texas Instruments Incorporated and its subsidiaries (TI) reserve the right to make corrections, modifications, enhancements, improvements, and other changes to its products and services at any time and to discontinue any product or service without notice. Customers should obtain the latest relevant information before placing orders and should verify that such information is current and complete. All products are sold subject to TI's terms and conditions of sale supplied at the time of order acknowledgment.

TI warrants performance of its hardware products to the specifications applicable at the time of sale in accordance with TI's standard warranty. Testing and other quality control techniques are used to the extent TI deems necessary to support this warranty. Except where mandated by government requirements, testing of all parameters of each product is not necessarily performed.

TI assumes no liability for applications assistance or customer product design. Customers are responsible for their products and applications using TI components. To minimize the risks associated with customer products and applications, customers should provide adequate design and operating safeguards.

TI does not warrant or represent that any license, either express or implied, is granted under any TI patent right, copyright, mask work right, or other TI intellectual property right relating to any combination, machine, or process in which TI products or services are used. Information published by TI regarding third-party products or services does not constitute a license from TI to use such products or services or a warranty or endorsement thereof. Use of such information may require a license from a third party under the patents or other intellectual property of the third party, or a license from TI under the patents or other intellectual property of TI.

Reproduction of TI information in TI data books or data sheets is permissible only if reproduction is without alteration and is accompanied by all associated warranties, conditions, limitations, and notices. Reproduction of this information with alteration is an unfair and deceptive business practice. TI is not responsible or liable for such altered documentation. Information of third parties may be subject to additional restrictions.

Resale of TI products or services with statements different from or beyond the parameters stated by TI for that product or service voids all express and any implied warranties for the associated TI product or service and is an unfair and deceptive business practice. TI is not responsible or liable for any such statements.

TI products are not authorized for use in safety-critical applications (such as life support) where a failure of the TI product would reasonably be expected to cause severe personal injury or death, unless officers of the parties have executed an agreement specifically governing such use. Buyers represent that they have all necessary expertise in the safety and regulatory ramifications of their applications, and acknowledge and agree that they are solely responsible for all legal, regulatory and safety-related requirements concerning their products and any use of TI products in such safety-critical applications, notwithstanding any applications-related information or support that may be provided by TI. Further, Buyers must fully indemnify TI and its representatives against any damages arising out of the use of TI products in such safety-critical applications.

TI products are neither designed nor intended for use in military/aerospace applications or environments unless the TI products are specifically designated by TI as military-grade or "enhanced plastic." Only products designated by TI as military-grade meet military specifications. Buyers acknowledge and agree that any such use of TI products which TI has not designated as military-grade is solely at the Buyer's risk, and that they are solely responsible for compliance with all legal and regulatory requirements in connection with such use.

TI products are neither designed nor intended for use in automotive applications or environments unless the specific TI products are designated by TI as compliant with ISO/TS 16949 requirements. Buyers acknowledge and agree that, if they use any non-designated products in automotive applications, TI will not be responsible for any failure to meet such requirements.

Following are URLs where you can obtain information on other Texas Instruments products and application solutions:

Products		Applications	
Amplifiers	amplifier.ti.com	Audio	www.ti.com/audio
Data Converters	dataconverter.ti.com	Automotive	www.ti.com/automotive
DLP® Products	www.dlp.com	Communications and Telecom	www.ti.com/communications
DSP	dsp.ti.com	Computers and Peripherals	www.ti.com/computers
Clocks and Timers	www.ti.com/clocks	Consumer Electronics	www.ti.com/consumer-apps
Interface	interface.ti.com	Energy	www.ti.com/energy
Logic	logic.ti.com	Industrial	www.ti.com/industrial
Power Mgmt	power.ti.com	Medical	www.ti.com/medical
Microcontrollers	microcontroller.ti.com	Security	www.ti.com/security
RFID	www.ti-rfid.com	Space, Avionics & Defense	www.ti.com/space-avionics-defense
RF/IF and ZigBee® Solutions	www.ti.com/lprf	Video and Imaging	www.ti.com/video
		Wireless	www.ti.com/wireless-apps

Mailing Address: Texas Instruments, Post Office Box 655303, Dallas, Texas 75265
Copyright © 2010, Texas Instruments Incorporated

www.BDTIC.com/TI