

Preliminary Data Sheet

Features

- For IF applications
- Typical 3 dB bandwidth of 1.5 MHz
- High attenuation
- Single-ended operation
- Ceramic Surface Mount Package (SMP)
- Replaces Sawtek P/N 851904 (BW 3dB = 1.5MHz)
- Hermetic
- RoHS compliant (2002/95/EC), Pb-free 

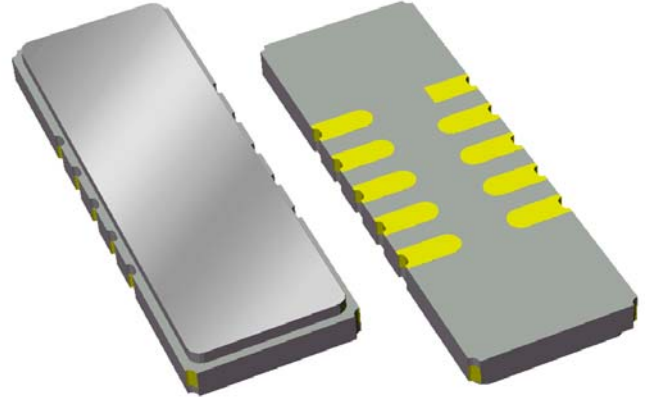

Package

Surface Mount 19.00 x 6.50 x 1.75 mm

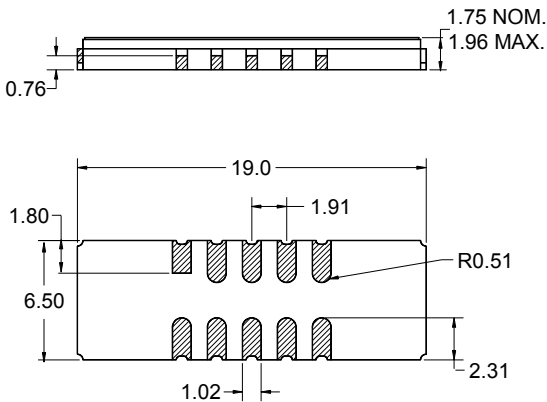

Pin Configuration

Bottom View

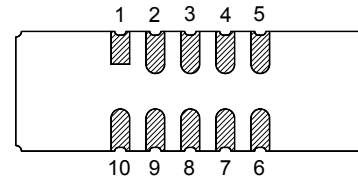

Pin No.	Description
5	RF output
10	RF input
1,6	Ground
2,3,4	Case ground
7,8,9	Case ground

Dimensions shown are nominal in millimeters
All tolerances are ± 0.15 mm except overall
length and width $+0.15$ mm/ -0.10 mm

Body: Al_2O_3 ceramic
Lid: Kovar, Ni plated
Terminations: Au plating 0.5 - 1.0 μ m,
over a 2 - 6 μ m Ni plating

Preliminary Data Sheet

Electrical Specifications ⁽¹⁾

Operating Temperature Range: ⁽²⁾ 0 to +70 °C

Parameter ⁽³⁾	Minimum	Typical	Maximum	Unit
Center Frequency	-	140	-	MHz
Minimum Insertion Loss	-	21.9	25	dB
Lower 1 dB Bandedge ⁽⁴⁾	-	139.363	139.45	MHz
Upper 1 dB Bandedge	140.55	140.637	-	MHz
Lower 3 dB Bandedge ⁽⁴⁾	-	139.228	139.315	MHz
Upper 3 dB Bandedge	140.685	140.761	-	MHz
Lower 40 dB Bandedge ⁽⁴⁾	138.645	138.734	-	MHz
Upper 40 dB Bandedge	-	141.291	141.355	MHz
Amplitude Variation 139.45 - 140.55 MHz	-	0.35	1	dB p-p
Phase Linearity 139.45 - 140.55 MHz	-	2.45	5.5	deg p-p
Group Delay Variation 139.45 - 140.55 MHz	-	90	160	ns p-p
Relative Attenuation ⁽⁴⁾				
15 - 138.3 MHz	50	61.2	-	dB
141.7 - 145 MHz	48	54.6	-	dB
145 - 155 MHz	42	55.4	-	dB
155 - 220 MHz	50	63.5	-	dB
220 - 240 MHz	27	47.4	-	dB
240 - 252 MHz	50	68.0	-	dB
252 - 270 MHz	21	29.0	-	dB
270 - 350 MHz	50	68.8	-	dB
Terminating Source Impedance ⁽⁵⁾	-	50	-	Ω
Terminating Load Impedance ⁽⁵⁾	-	50	-	Ω

Notes:

1. All specifications are based on the test circuit shown below
2. In production, devices will be tested at room temperature to a guardbanded specification to ensure electrical compliance over temperature
3. Electrical margin has been built into the design to account for the variations due to temperature and manufacturing tolerances
4. All attenuation measurements are measured relative to minimum insertion loss
5. This is the optimum impedance in order to achieve the performance shown

Test Circuit:

Actual matching values may vary due to PCB layout and parasitics

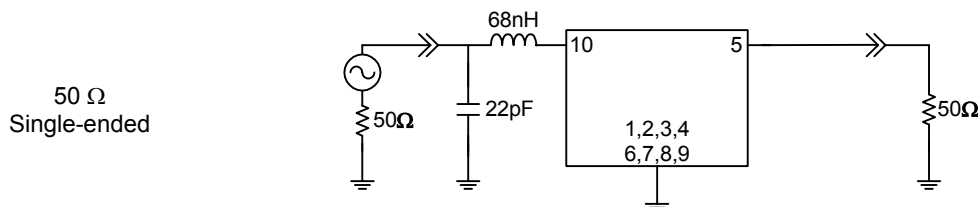

Preliminary Data Sheet

Typical Performance (at +25°C)

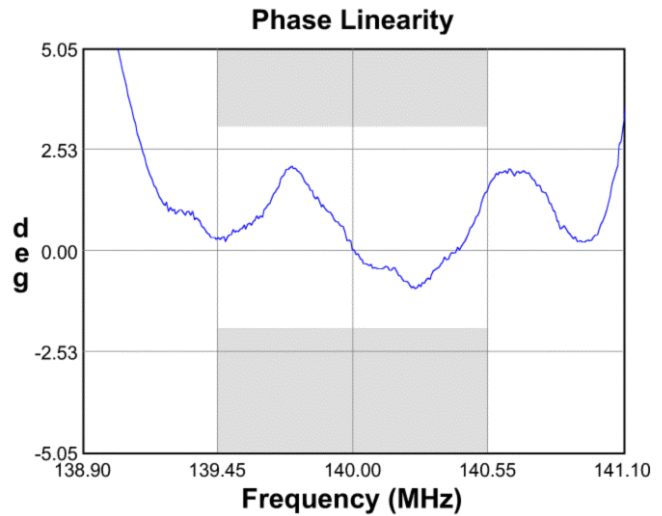
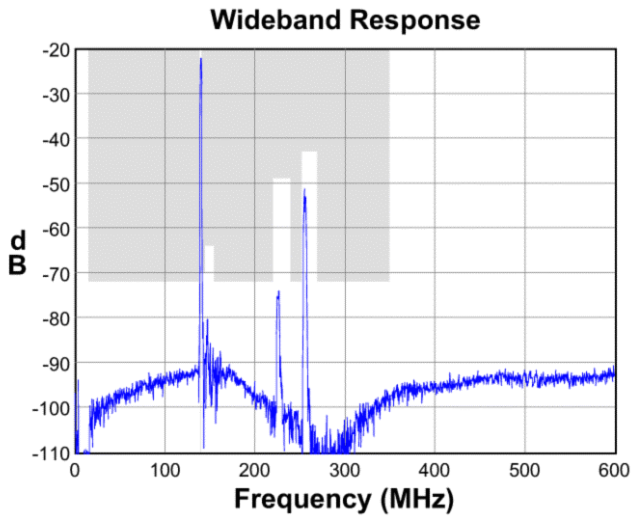
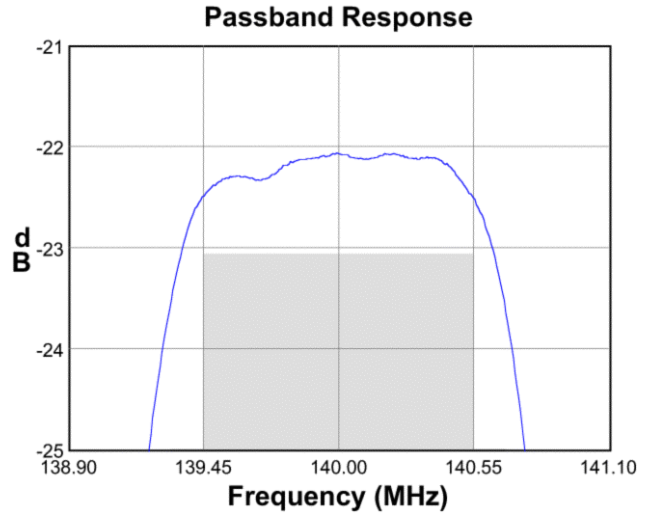
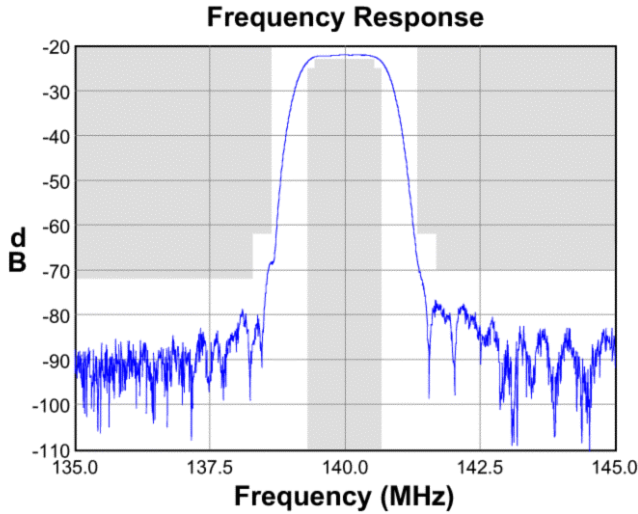

Input Smith Chart

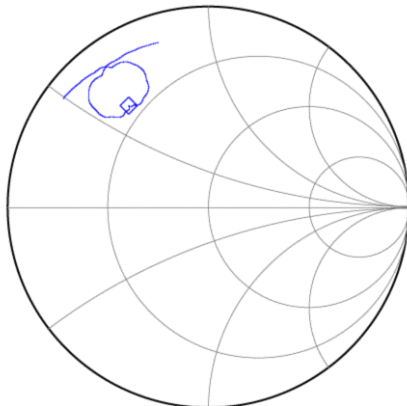

Output Smith Chart

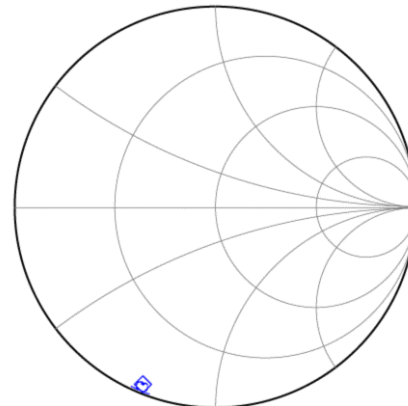

Preliminary Data Sheet

Matching Schematics

Actual matching values may vary due to PCB layout and parasitics

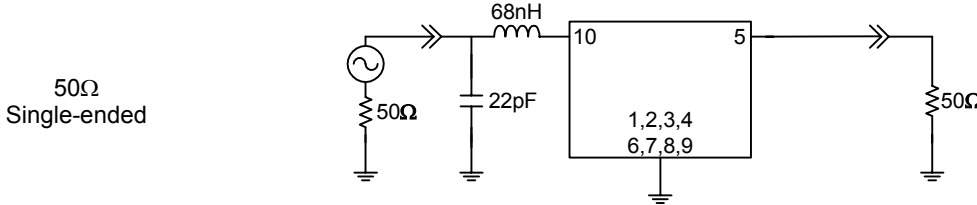

Marking

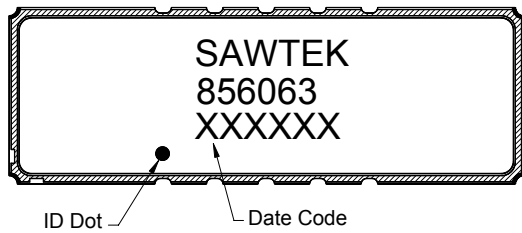

The date code consists of: day of the current year (Julian, 3 digits), last digit of the year (1 digit) and hour (2 digits)

PCB Footprint

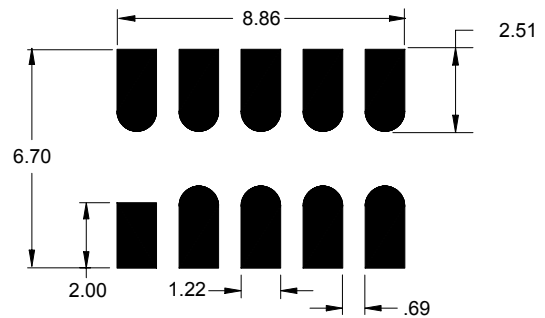

This footprint represents a recommendation only
Dimensions shown are nominal in millimeters

Tape and Reel

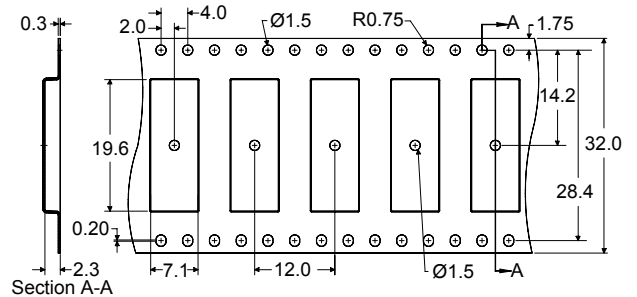
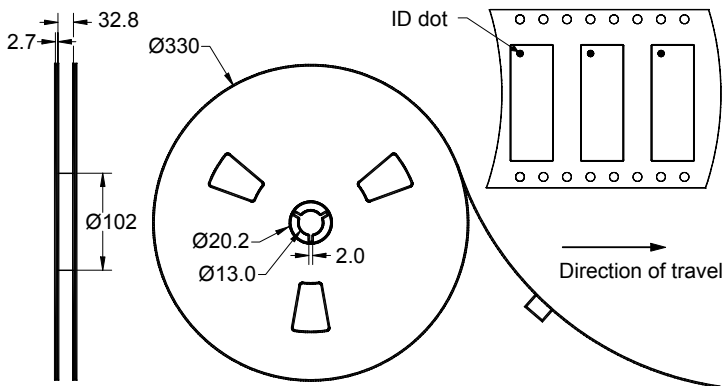

Dimensions shown are nominal in millimeters
Packaging quantity: 2000 units/reel

Preliminary Data Sheet

Maximum Ratings

Parameter	Symbol	Minimum	Maximum	Unit
Operating Temperature Range	T	0	+70	°C
Storage Temperature Range	T _{stg}	-40	+85	°C

Important Notes

Warnings

- Electrostatic Sensitive Device (ESD) 
- Avoid ultrasonic exposure

RoHS Compliance

- This product complies with EU directive 2002/95/EC (RoHS) 

Solderability

- Compatible with JEDEC J-STD-020C **Pb-free** process, **260°C** peak reflow temperature ([see soldering profile](#))

Links to Additional Technical Information

[PCB Layout Tips](#)

[Qualification Flowchart](#)

[Soldering Profile](#)

[S-Parameters](#)

[RoHS Information](#)

[Other Technical Information](#)

Sawtek's liability is limited only to the Surface Acoustic Wave (SAW) component(s) described in this data sheet. Sawtek does not accept any liability for applications, processes, circuits or assemblies, which are implemented using any Sawtek component described in this data sheet.

Contact Information



PO Box 609501
 Orlando, FL 32860-9501
 USA

Phone: +1 (407) 886-8860
 Fax: +1 (407) 886-7061
 Email: custservice@sawtek.com
 Web: www.sawtek.com

Or contact one of our worldwide
 Network of [sales offices](#),
[representatives or distributors](#)