

# Preliminary Data Sheet

## Features

- For AMPS, CDMA and TDMA repeater and booster applications
- Usable bandwidth 25 MHz
- High attenuation
- No impedance matching required for operation at 50 Ω
- Single-ended operation
- Ceramic Surface Mount Package (SMP)
- Hermetic
- RoHS compliant (2002/95/EC), Pb-free 

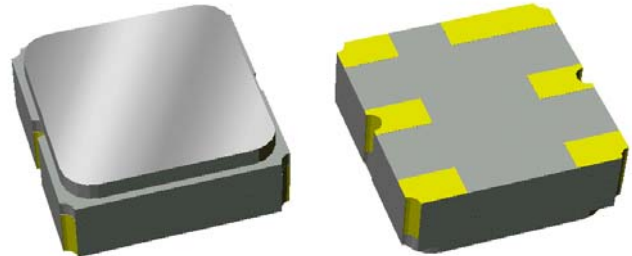

## Package

Surface Mount 3.00 x 3.00 x 1.22 mm

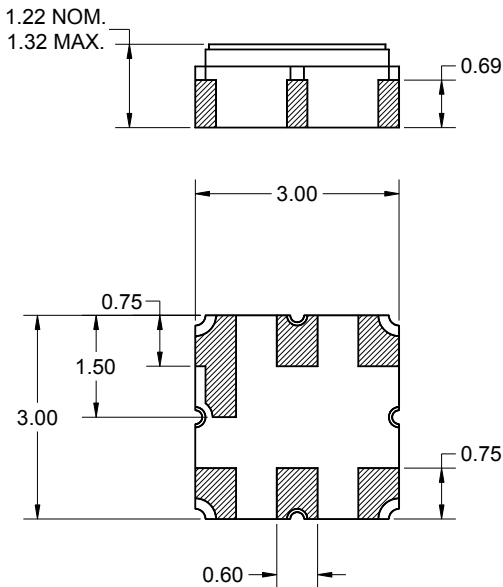

## Pin Configuration

Bottom View

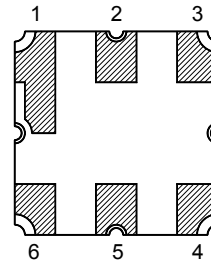

Pin No.	Description
2,5	Input/Output
1,3,4,6	Case ground

Dimensions shown are nominal in millimeters  
 All tolerances are  $\pm 0.15$ mm except overall  
 length and width  $\pm 0.10$ mm

Body:  $Al_2O_3$  ceramic  
 Lid: Kovar, Ni plated  
 Terminations: Au plating 0.5 - 1.0 $\mu$ m,  
 over a 2 - 6 $\mu$ m Ni plating

# Preliminary Data Sheet

## Electrical Specifications <sup>(1)</sup>

Operating Temperature Range: <sup>(2)</sup> -30 to +80 °C

Parameter <sup>(3)</sup>	Minimum	Typical	Maximum	Unit
<b>Center Frequency</b>	-	881.5	-	MHz
<b>Maximum Insertion Loss</b> 869 - 894 MHz	-	2.7	3.5	dB
<b>Amplitude Variation</b> 869 - 894 MHz	-	0.8	1.5	dB p-p
<b>Absolute Attenuation</b> 10 - 779 MHz	45	50	-	dB
779 - 849 MHz	40	45	-	dB
849 - 859 MHz (at +25 °C only)	12	15	-	dB
914 - 970 MHz	25	33	-	dB
970 - 1049 MHz	45	55	-	dB
1049 - 2000 MHz	40	50	-	dB
<b>Input/Output VSWR</b> 869 - 894 MHz	-	1.7:1	2.5:1	-
<b>Source Impedance:</b> <sup>(4)</sup>	-	50	-	Ω
<b>Load Impedance:</b> <sup>(4)</sup>	-	50	-	Ω

### Notes:

1. All specifications are based on the test circuit shown below
2. In production, devices will be tested at room temperature to a guardbanded specification to ensure electrical compliance over temperature
3. Electrical margin has been built into the design to account for the variations due to temperature drift and manufacturing tolerances
4. This is the optimum impedance in order to achieve the performance shown

### Test Circuit:

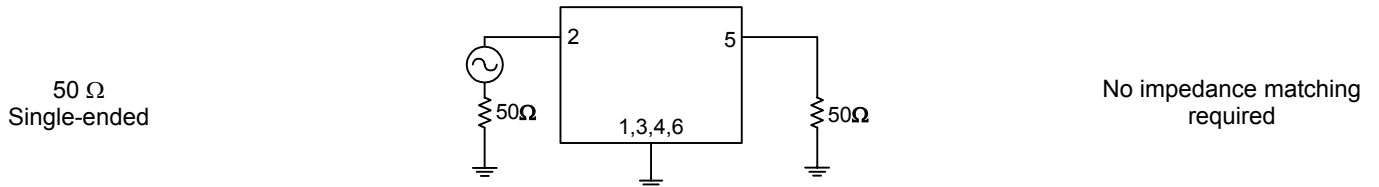

**Preliminary Data Sheet**

**Typical Performance (at +25°C)**

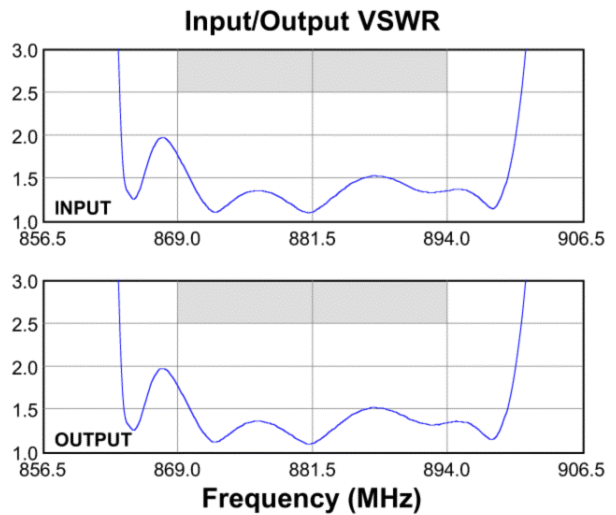
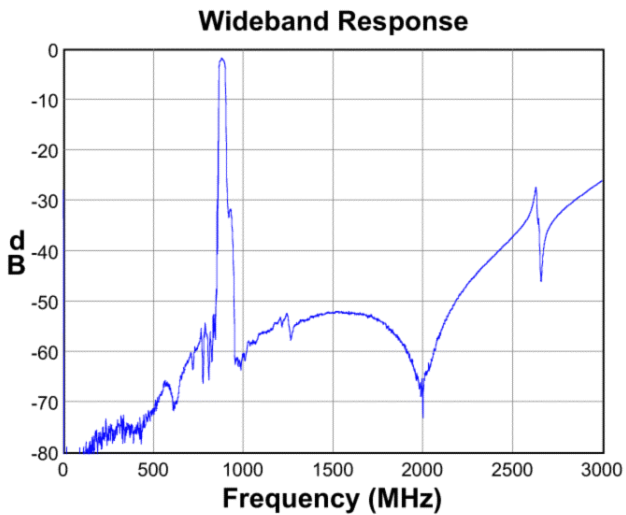
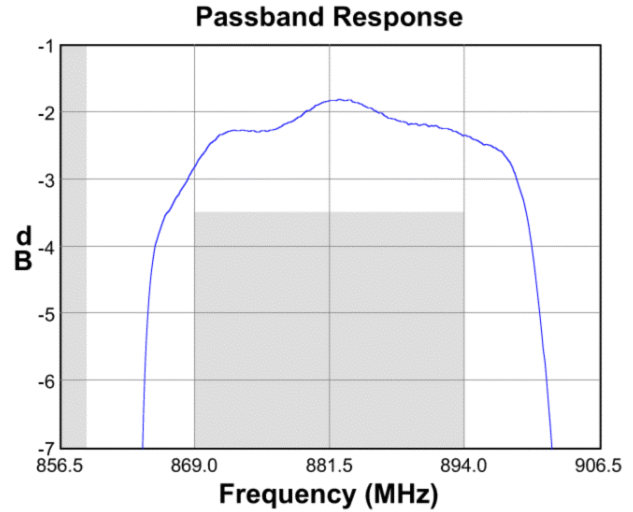
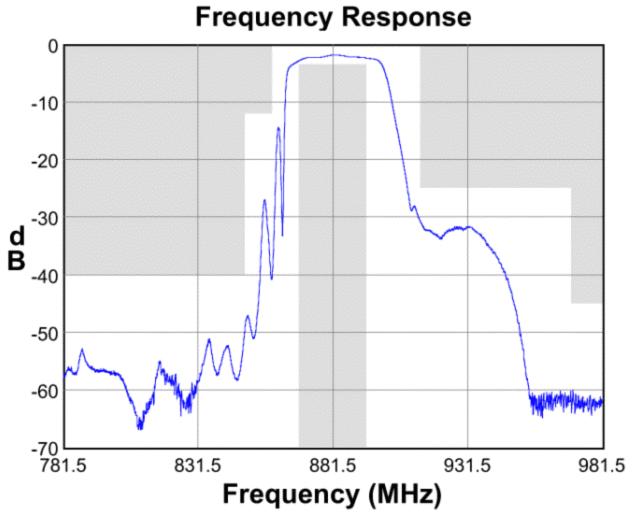

**Input Smith Chart**

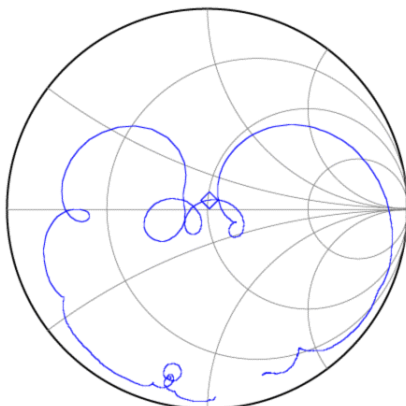

**Output Smith Chart**

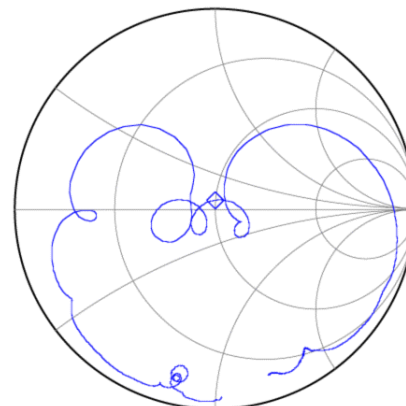

**Preliminary Data Sheet**

**Matching Schematics**

50 Ω  
Single-ended

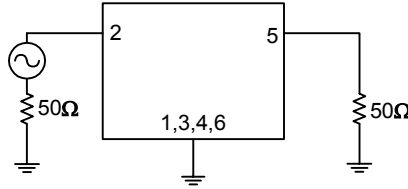

No impedance matching required

**Marking**

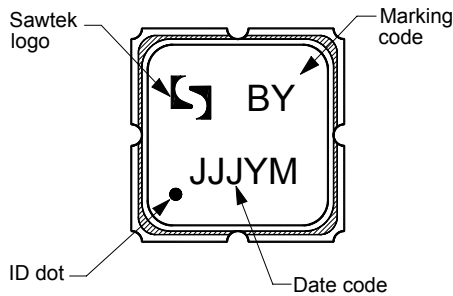

The date code consists of: JJJ = Julian day,  
Y = last digit of year, M = manufacturing site code

**PCB Footprint**

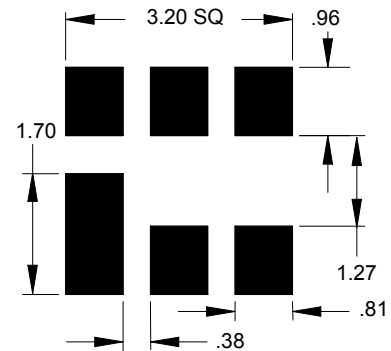

This footprint represents a recommendation only  
Dimensions shown are nominal in millimeters

**Tape and Reel**

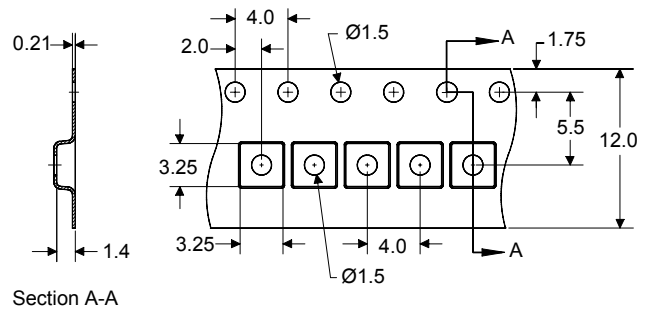
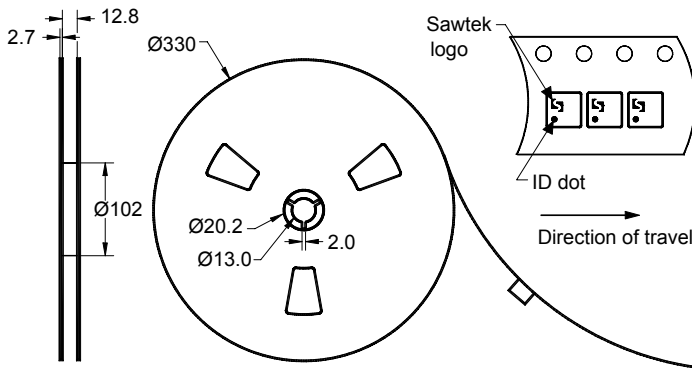

Dimensions shown are nominal in millimeters  
Packaging quantity: 5000 units/reel

# Preliminary Data Sheet

## Maximum Ratings

Parameter	Symbol	Minimum	Maximum	Unit
Operating Temperature Range	T	-30	+80	°C
Storage Temperature Range	T <sub>stg</sub>	-40	+85	°C
Input Power	P <sub>in</sub>	-	+10	dBm

## Important Notes

### Warnings

- Electrostatic Sensitive Device (ESD) 
- Avoid ultrasonic exposure

### RoHS Compliance

- This product complies with EU directive 2002/95/EC (RoHS) 

### Solderability

- Compatible with JEDEC J-STD-020C **Pb-free** process, **260°C** peak reflow temperature ([see soldering profile](#))

## Links to Additional Technical Information

[PCB Layout Tips](#)

[Qualification Flowchart](#)

[Soldering Profile](#)

[S-Parameters](#)

[RoHS information](#)

[Other Technical Information](#)

Sawtek's liability is limited only to the Surface Acoustic Wave (SAW) component(s) described in this data sheet. Sawtek does not accept any liability for applications, processes, circuits or assemblies, which are implemented using any Sawtek component described in this data sheet.

## Contact Information



PO Box 609501  
 Orlando, FL 32860-9501  
 USA

Phone: +1 (407) 886-8860  
 Fax: +1 (407) 886-7061  
 Email: [custservice@sawtek.com](mailto:custservice@sawtek.com)  
 Web: [www.sawtek.com](http://www.sawtek.com)

Or contact one of our worldwide  
 Network of [sales offices](#),  
[representatives or distributors](#)