

Features

- For WCDMA applications
- Usable bandwidth of 8.84 MHz
- Low loss
- High attenuation
- Single-ended input
- Single-ended or balanced output
- Ceramic Surface Mount Package (SMP)
- Small size
- Hermetic
- RoHS compliant (2002/95/EC), Pb-free 

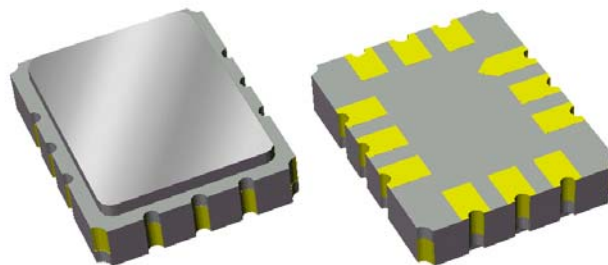

Package

Surface Mount 7.01 x 5.51 x 1.70 mm

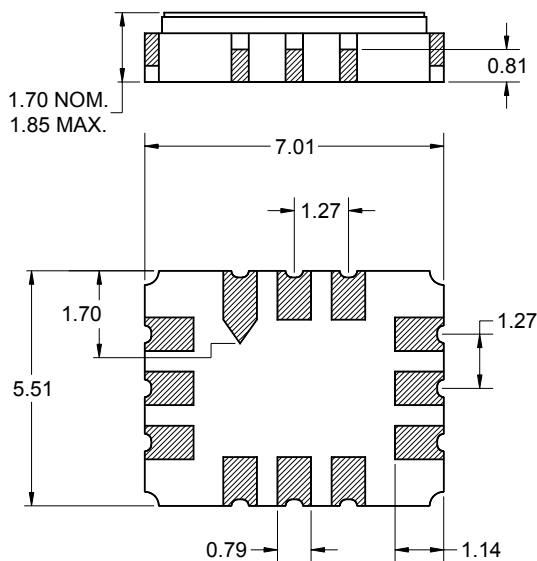

Dimensions shown are nominal in millimeters
All tolerances are ± 0.15 mm except overall length and width ± 0.13 mm

Body: Al_2O_3 ceramic
Lid: Kovar, Ni plated
Terminations: Au plating 0.5 - 1.0 μ m, over a 2 - 6 μ m Ni plating

Pin Configuration

Bottom View

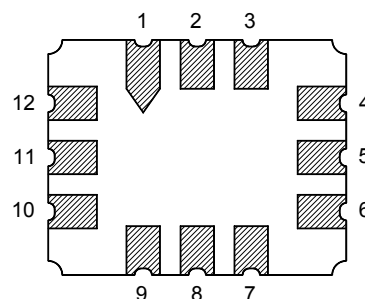

Pin No.	Description
10	Input
4	Output +
6	Output -
3,9,12	To be grounded
1,2,5	Case Ground
7,8,11	Case Ground

Electrical Specifications ⁽¹⁾

Operating Temperature Range: ⁽²⁾ -40 to +85°C

Parameter ⁽³⁾	Minimum	Typical	Maximum	Unit
Center Frequency (Fc)	-	172.8	-	MHz
Maximum Insertion Loss Fc ± 4.42 MHz	-	9.0	12.5	dB
Attenuation ⁽⁴⁾				
Fc ± 8.0 MHz to Fc ± 11.0 MHz	32	43	-	dB
Fc ± 11.0 MHz to Fc ± 25.0 MHz	37	45	-	dB
Fc ± 25.0 MHz to Fc ± 34.0 MHz	45	55	-	dB
Fc ± 34.0 MHz to Fc ± 100.0 MHz	55	60	-	dB
Amplitude Variation Fc ± 4.42 MHz	-	0.5	1.3	dB
Group Delay Variation Fc ± 4.42 MHz	-	50	150	ns
Phase Variation Fc ± 4.42 MHz	-	4	-	deg
Input/Output VSWR Fc ± 4.42 MHz	-	1.5:1	2.0:1	
Source Impedance (single ended) ⁽⁵⁾	-	50	-	Ω
Load Impedance: (balanced) ⁽⁵⁾	-	200	-	Ω

Notes:

1. All specifications are based on Triquint test circuit shown below
2. In production, devices will be tested at room temperature to a guardbanded specification to ensure electrical compliance over temperature
3. Electrical margin has been built into the design to account for the variations due to temperature drift and manufacturing tolerances
4. Relative to the maximum insertion loss
5. This is the optimum impedance in order to achieve the performance shown

Test Circuit:

Actual matching values may vary due to PCB layout and parasitics

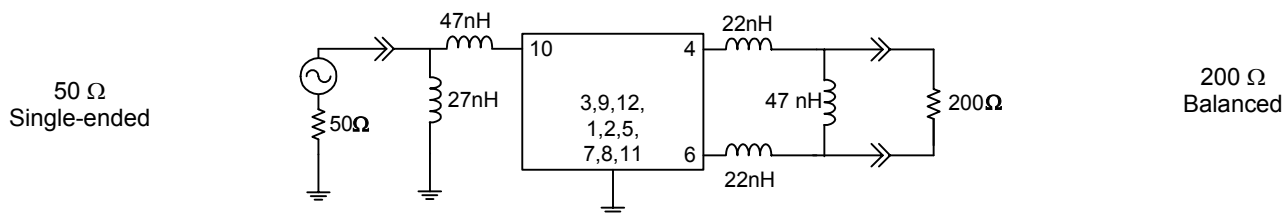

Typical Performance (at +25°C)

Frequency Response

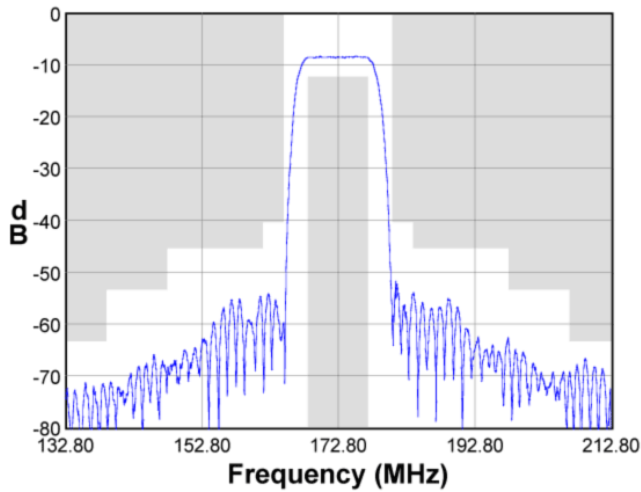

Passband Response

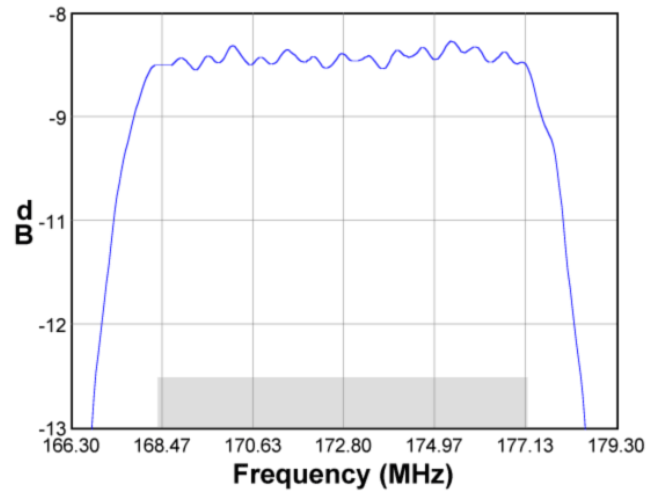

Wideband Response

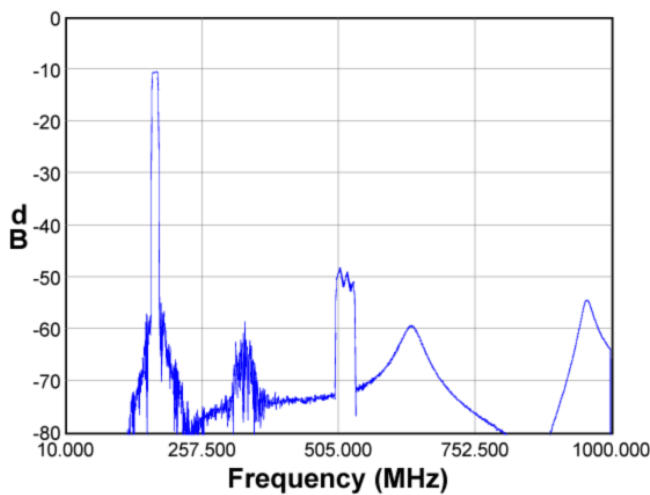

Group Delay Variation

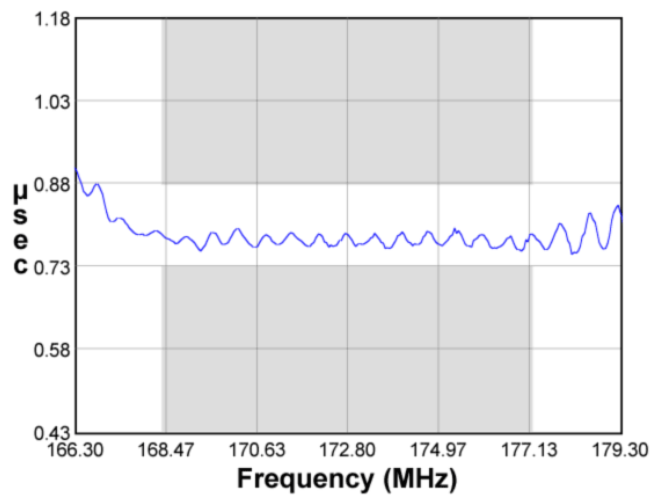

Input Smith Chart

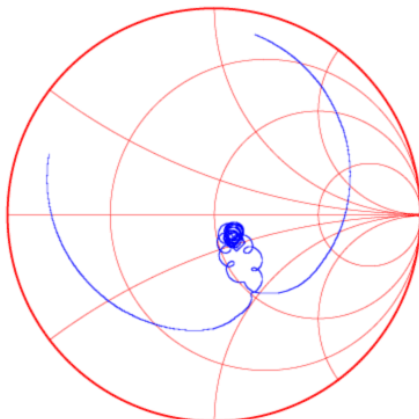

Output Smith Chart

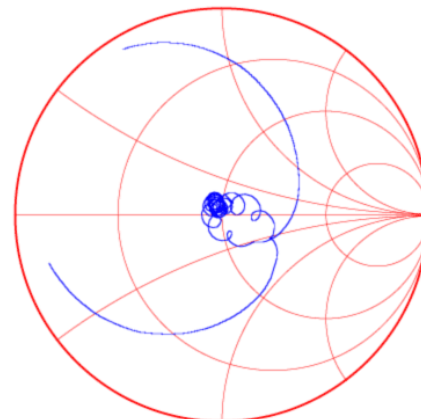

Matching Schematics

Actual matching values may vary due to PCB layout and parasitics

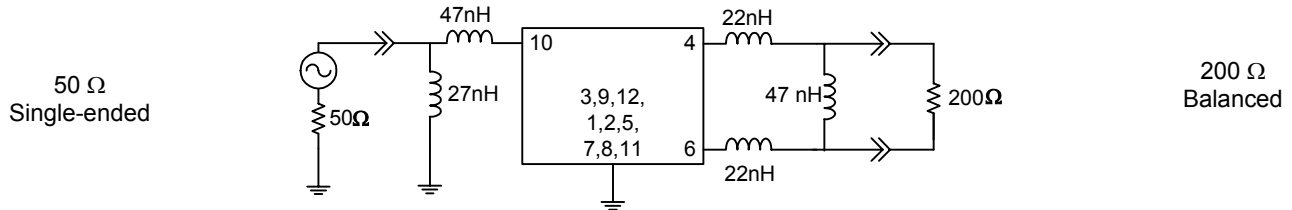

Marking

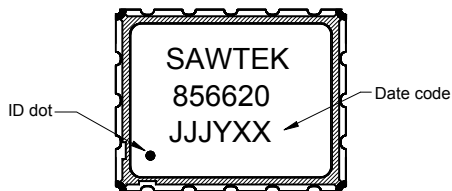

The date code consists of: day of the current year (Julian, 3 digits), last digit of the year (1 digit) and hour (2 digits)

PCB Footprint

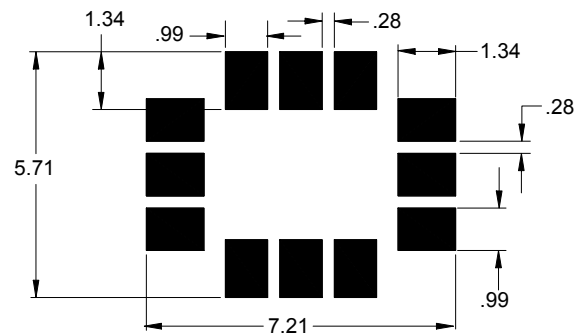

This footprint represents a recommendation only
Dimensions shown are nominal in millimeters

Tape and Reel

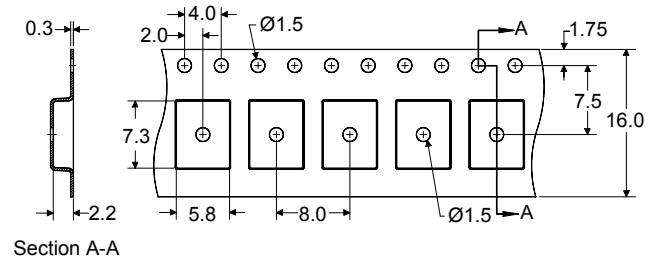
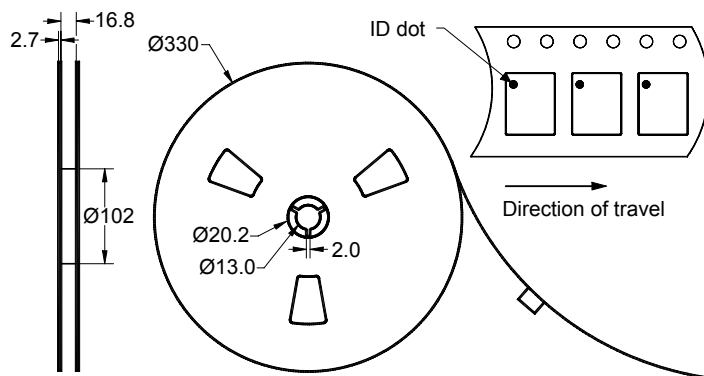

Dimensions shown are nominal in millimeters
Packaging quantity: 3000 units/reel

Data Sheet

Maximum Ratings

Parameter	Symbol	Minimum	Maximum	Unit
Operating Temperature Range	T	-40	+85	°C
Storage Temperature Range	T _{stg}	-40	+85	°C

Warnings

- Electrostatic Sensitive Device (ESD) 
- Avoid ultrasonic exposure

RoHS Compliance

- This product complies with EU directive 2002/95/EC (RoHS) 

Solderability

- Compatible with JEDEC J-STD-020C **Pb-free** process, **260°C** peak reflow temperature ([see soldering profile](#))

Links to Additional Technical Information

[PCB Layout Tips](#)

[Qualification Flowchart](#)

[Soldering Profile](#)

[S-Parameters](#)

[RoHS Information](#)

[Other Technical Information](#)

TriQuint's liability is limited only to the Surface Acoustic Wave (SAW) component(s) described in this data sheet. TriQuint does not accept any liability for applications, processes, circuits or assemblies which are implemented using any TriQuint component described in this data sheet.

Contact Information

TriQuint 
SEMICONDUCTOR

PO Box 609501
Orlando, FL 32860-9501
USA

Phone: +1 (407) 886-8860
Fax: +1 (407) 886-7061
Email: info-product@tqs.com
Web: www.triquint.com

Or contact one of our worldwide
Network of [sales offices](#),
[Representatives or distributors](#)