

Features

- Usable bandwidth 35 MHz
- High attenuation
- No impedance matching required for operation at 50 Ω
- Single-ended operation
- Ceramic Surface Mount Package (SMP)
- Hermetic
- RoHS compliant (2002/95/EC), Pb-free 

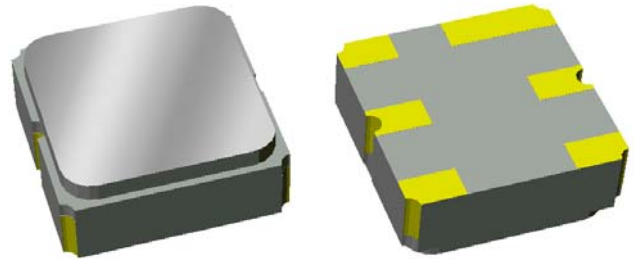

Package

Surface Mount 3.00 x 3.00 x 1.22 mm

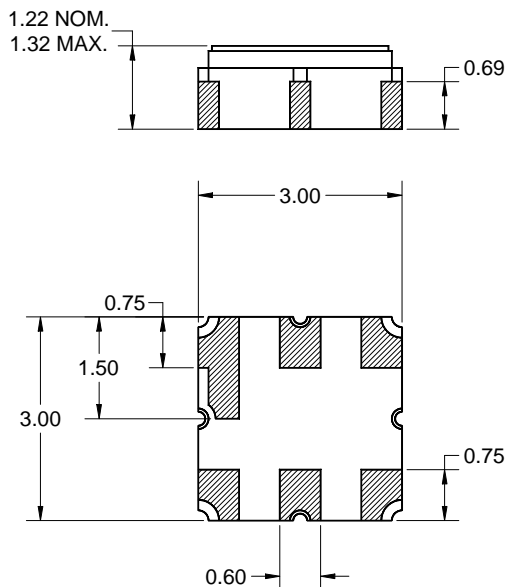

Pin Configuration

Bottom View

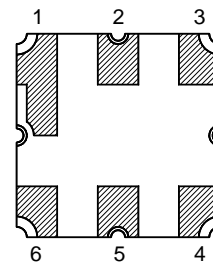

Pin No.	Description
2	Input
5	Output
1,3,4,6	Case ground

Dimensions shown are nominal in millimeters
All tolerances are $\pm 0.15\text{mm}$ except overall
length and width $\pm 0.10\text{mm}$

Body: Al_2O_3 ceramic
Lid: Kovar, Ni plated
Terminations: Au plating 0.5 - 1.0 μm ,
over a 2 - 6 μm Ni plating

Electrical Specifications ⁽¹⁾

Operating Temperature Range: ⁽²⁾ -10 to +80 °C

Parameter ⁽³⁾	Minimum	Typical	Maximum	Unit
Center Frequency	-	897.5	-	MHz
Maximum Insertion Loss 880 - 915 MHz	-	1.8	2.5	dB
Amplitude Ripple 880 - 915 MHz	-	1.0	1.6	dB p-p
Absolute Attenuation				
10 - 860 MHz	19	22	-	dB
860 - 865 MHz	20	26	-	dB
930 - 935 MHz	14	55	-	dB
935 - 960 MHz	25	28	-	dB
960 - 1780 MHz	21	24	-	dB
1780 - 1850 MHz	21	30	-	dB
1850 - 2250 MHz	15	20	-	dB
2250 - 3000 MHz	6	13	-	dB
Input/Output VSWR 880 - 915 MHz	-	1.8	2.2	-
Source Impedance ⁽⁴⁾	-	50	-	Ω
Load Impedance ⁽⁴⁾	-	50	-	Ω

Notes:

1. All specifications are based on the test circuit shown below
2. In production, devices will be tested at room temperature to a guardbanded specification to ensure electrical compliance over temperature
3. Electrical margin has been built into the design to account for the variations due to temperature drift and manufacturing tolerances
4. This is the optimum impedance in order to achieve the performance shown

Test Circuit:

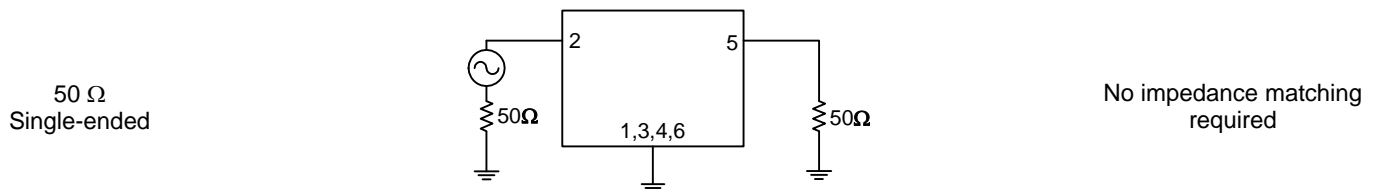

Electrical Specifications ⁽¹⁾

Operating Temperature Range: ⁽²⁾ -30 to +85 °C

Parameter ⁽³⁾	Minimum	Typical	Maximum	Unit
Center Frequency	-	897.5	-	MHz
Maximum Insertion Loss 880 - 915 MHz	-	1.8	2.8	dB
Amplitude Ripple 880 - 915 MHz	-	1.0	1.8	dB p-p
Absolute Attenuation 10 - 860 MHz	19	22	-	dB
860 - 865 MHz	20	26	-	dB
930 - 935 MHz	14	55	-	dB
935 - 960 MHz	25	28	-	dB
960 - 1780 MHz	21	24	-	dB
1780 - 1850 MHz	21	30	-	dB
1850 - 2250 MHz	15	20	-	dB
2250 - 3000 MHz	6	13	-	dB
Input/Output VSWR 880 - 915 MHz	-	1.8	2.2	-
Source Impedance ⁽⁴⁾	-	50	-	Ω
Load Impedance ⁽⁴⁾	-	50	-	Ω

Notes:

1. All specifications are based on the test circuit shown below
2. In production, devices will be tested at room temperature to a guardbanded specification to ensure electrical compliance over temperature
3. Electrical margin has been built into the design to account for the variations due to temperature drift and manufacturing tolerances
4. This is the optimum impedance in order to achieve the performance shown

Test Circuit:

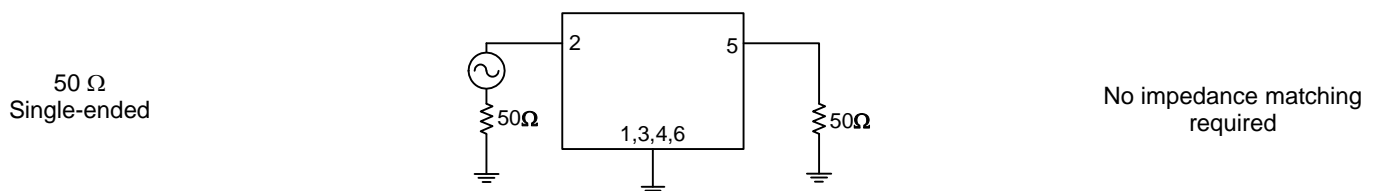

Typical Performance (at +25°C)

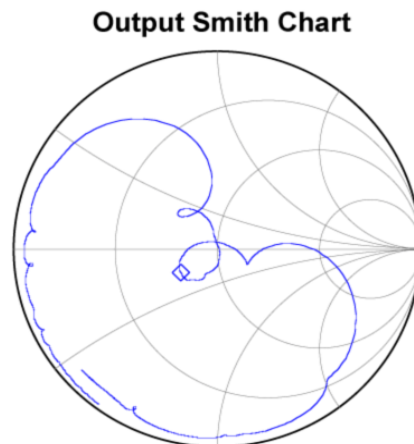
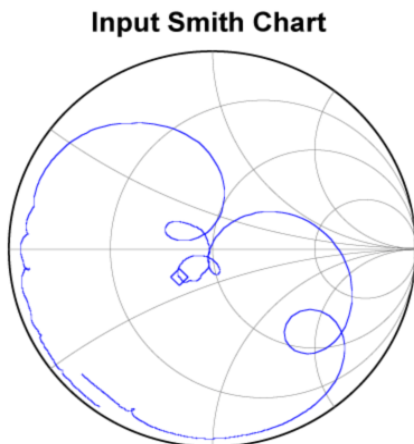
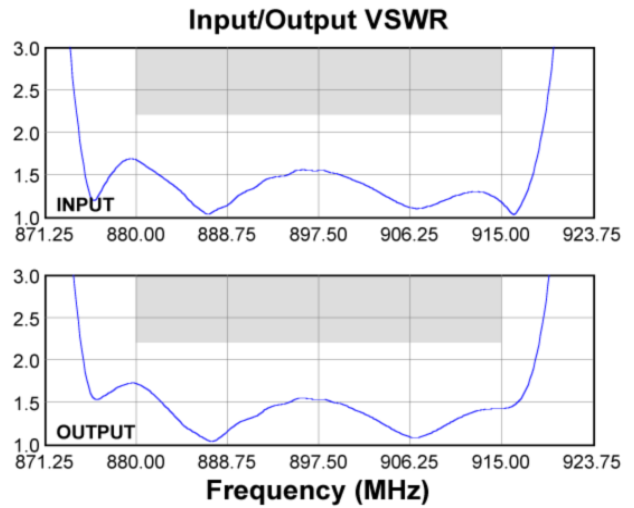
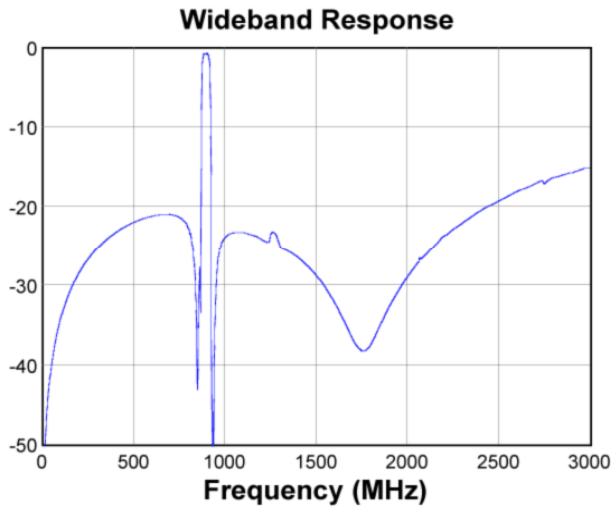
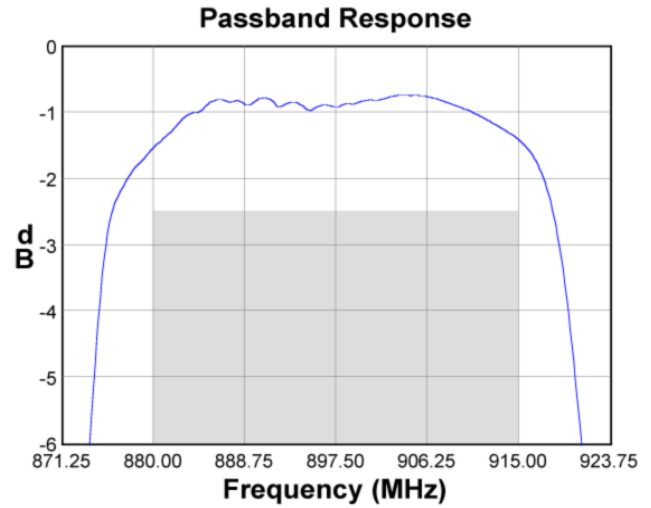
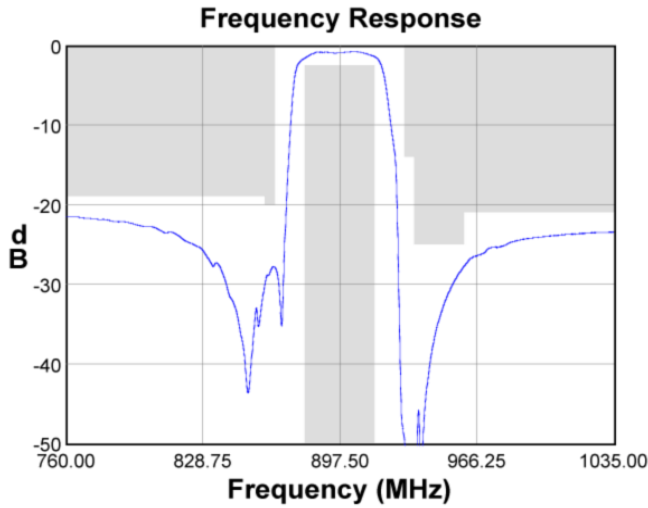

Matching Schematics

50 Ω
Single-ended

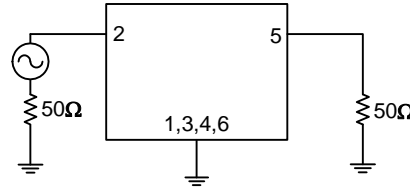

No impedance matching required

Marking

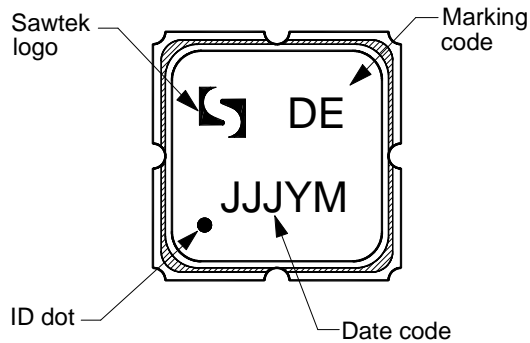

The date code consists of: JJJ = Julian day,
Y = last digit of year, M = manufacturing site code

PCB Footprint

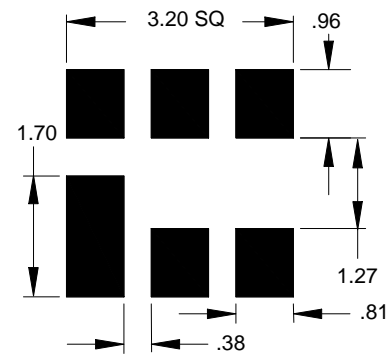

This footprint represents a recommendation only
Dimensions shown are nominal in millimeters

Tape and Reel

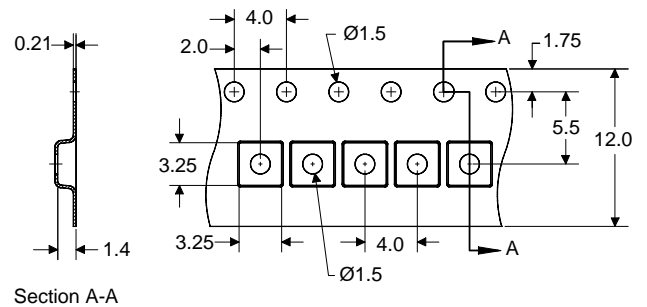
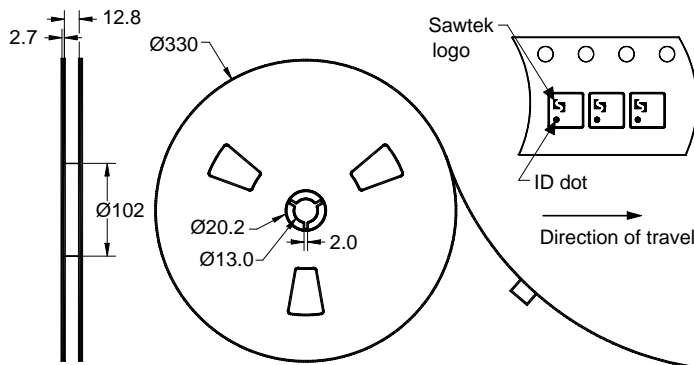

Dimensions shown are nominal in millimeters
Packaging quantity: 5000 units/reel

Maximum Ratings

Parameter	Symbol	Minimum	Maximum	Unit
Operating Temperature Range	T	-30	+85	°C
Storage Temperature Range	T _{stg}	-40	+85	°C
Input Power	P _{in}	-	+17	dBm

Important Notes

Warnings

- Electrostatic Sensitive Device (ESD) 
- Avoid ultrasonic exposure

RoHS Compliance

- This product complies with EU directive 2002/95/EC (RoHS) 

Solderability

- Compatible with JEDEC J-STD-020C **Pb-free** process, **260°C** peak reflow temperature ([see soldering profile](#))

Links to Additional Technical Information

[PCB Layout Tips](#)

[Qualification Flowchart](#)

[Soldering Profile](#)

[S-Parameters](#)

[RoHS Information](#)

[Other Technical Information](#)

TriQuint's liability is limited only to the Surface Acoustic Wave (SAW) component(s) described in this data sheet. TriQuint does not accept any liability for applications, processes, circuits or assemblies, which are implemented using any TriQuint component described in this data sheet.

Contact Information

TriQuint 
SEMICONDUCTOR

PO Box 609501
Orlando, FL 32860-9501
USA

Phone: +1 (407) 886-8860
Fax: +1 (407) 886-7061
Email: info-product@tqs.com
Web: www.triquint.com

Or contact one of our worldwide
Network of [sales offices](#),
[Representatives or distributors](#)