

Features

- For BTS Power Amplifier applications
- Usable bandwidth of 100 MHz
- Absolute delay of 450ns
- Low group delay variation
- Ceramic Surface Mount Package (SMP)
- Hermetic
- RoHS compliant (2002/95/EC), Pb-free 

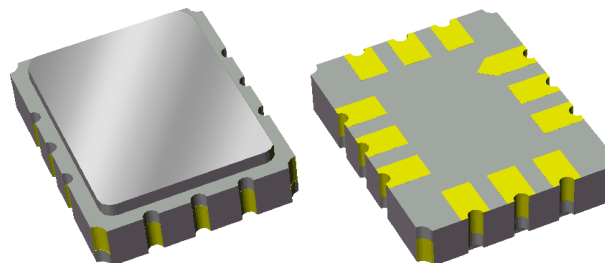

Package

Surface Mount 7.01 x 5.51 x 1.63 mm
SMP-28B

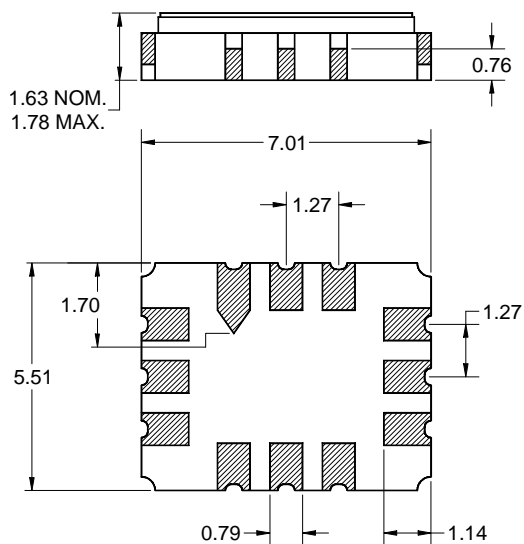

Dimensions shown are nominal in millimeters
All tolerances are ± 0.15 mm except overall
length and width ± 0.13 mm

Body: Al_2O_3 ceramic
Lid: Kovar, Ni plated
Terminations: Au plating 0.5 - 1.0 μ m,
over a 2 - 6 μ m Ni plating

Pin Configuration

Bottom View

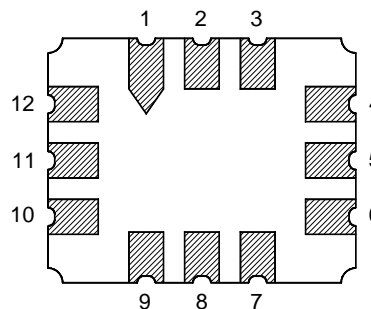

Single-ended Configuration

Pin No.	Description
10	Input
4	Output
1,2,5,7,8,11	Case Ground
3,6,9,12	Ground

Electrical Specifications ⁽¹⁾

Operating Temperature Range: ⁽²⁾ -35 to +85 °C

Parameter ⁽³⁾	Minimum	Typical ⁽⁴⁾	Maximum	Unit
Center Frequency	-	1960	-	MHz
Minimum Insertion Loss				
+25 °C	-	22	26	dB
-35 to +85 °C	-	23	27	dB
Lower 1.2 dB Bandedge ⁽⁵⁾	-	1884	1930	MHz
Upper 1.2 dB Bandedge ⁽⁵⁾	1990	2013	-	MHz
Amplitude Variation				
1950 – 1970 MHz	-	0.4	0.8	dB p-p
1930 – 1990 MHz	-	0.5	1.2	dB p-p
Phase Linearity				
1950 – 1970 MHz	-	3	7.0	degree
1930 – 1990 MHz	-	4	8.0	degree
Absolute Group Delay	445	450	455	ns
Group Delay Variation				
1930 – 1990 MHz	-	24	40	ns p-p
Input VSWR				
1950 – 1970 MHz	-	3.4	5.0:1	-
Output VSWR				
1950 – 1970 MHz	-	2.1	5.0:1	-
Source Impedance (single-ended) ⁽⁶⁾	-	50	-	Ω
Load Impedance (single-ended) ⁽⁶⁾	-	50	-	Ω

Notes:

1. All specifications are based on the TriQuint test circuit shown below
2. In production, devices will be tested at room temperature to a guardbanded specification to ensure electrical compliance over temperature
3. Electrical margin has been built into the design to account for the variations due to temperature drift and manufacturing tolerances
4. Typical values are based on average measurements at room temperature
5. Relative to minimum insertion loss
6. This is the optimum impedance in order to achieve the performance shown

Test Circuit:

Actual matching values may vary due to PCB layout and parasitics

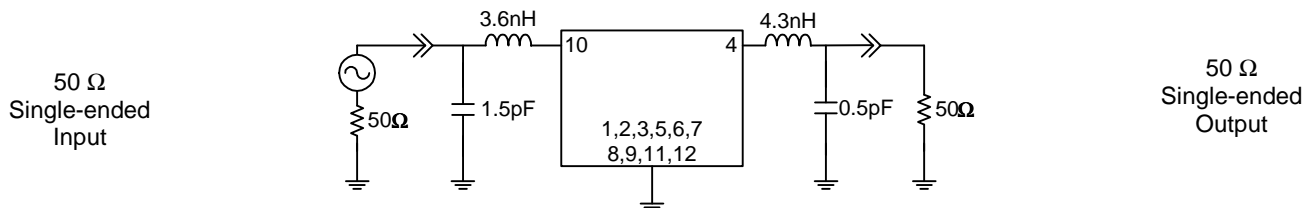

Typical Performance (at room temperature)

Frequency Response

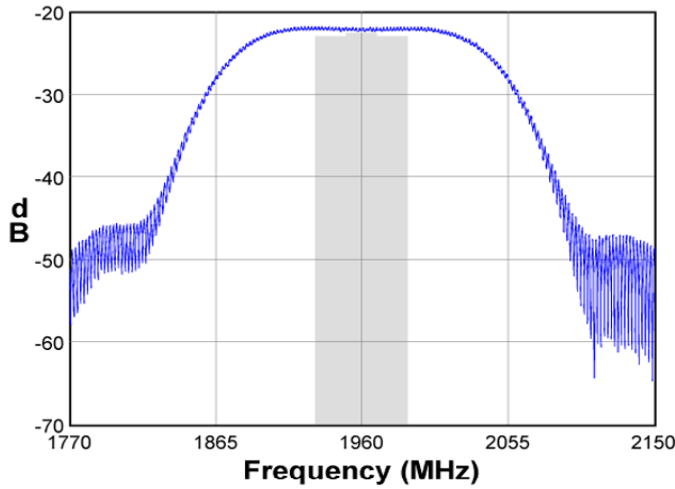

Passband Response

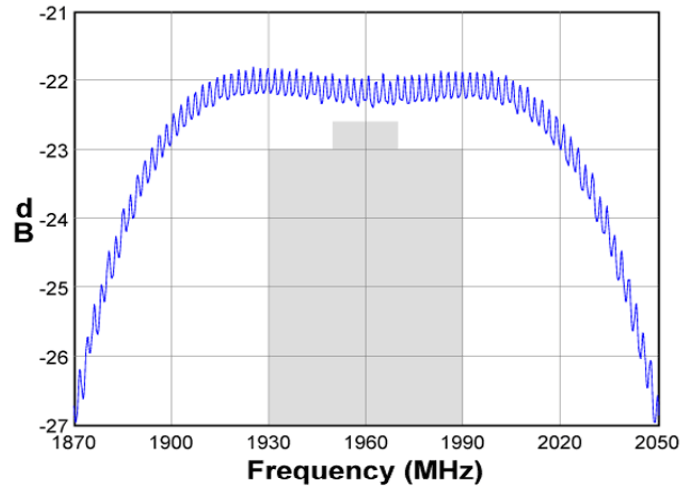

Wideband Response

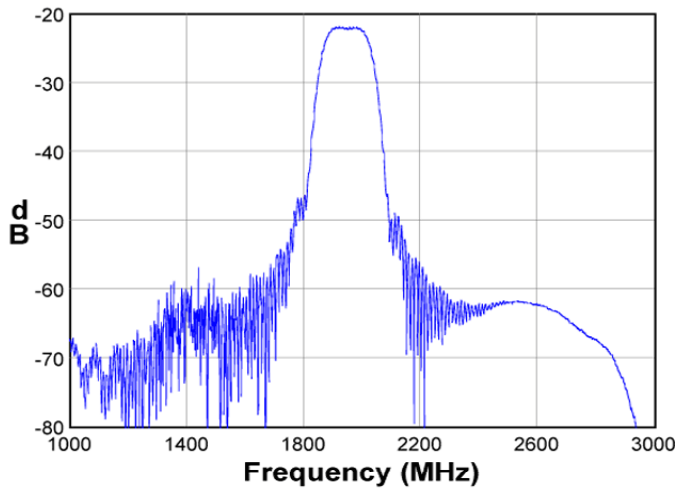

Phase \ Group Delay

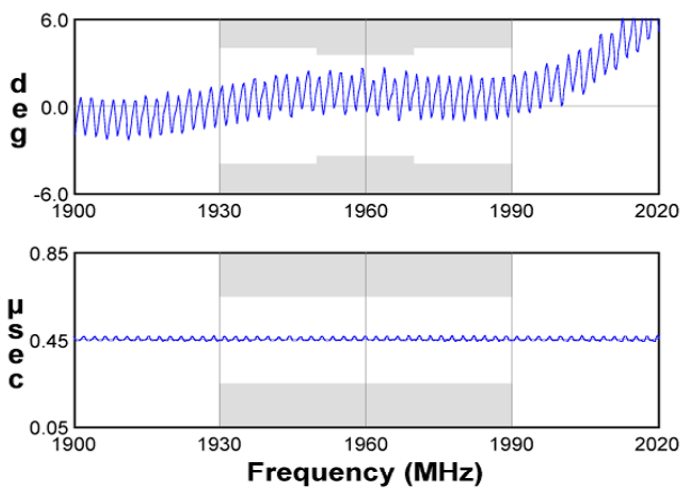

Input Smith Chart

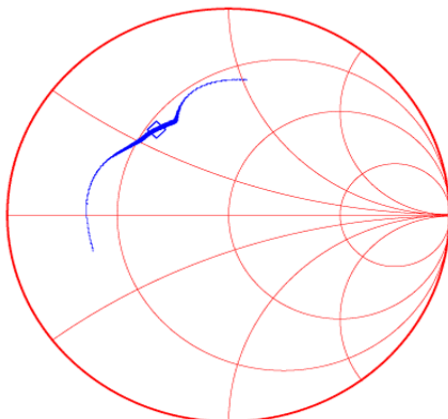

Output Smith Chart

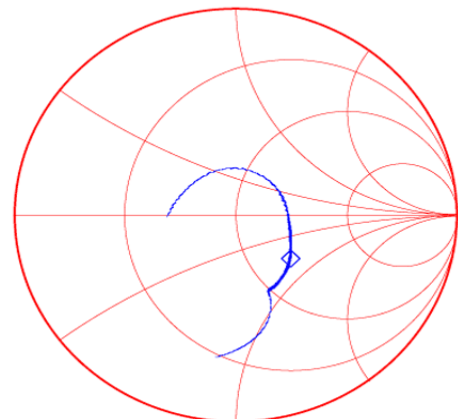

Matching Schematics

Actual matching values may vary due to PCB layout and parasitics

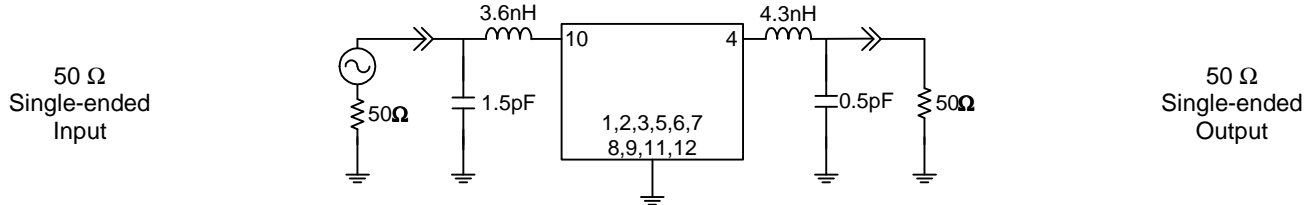

Marking

PCB Footprint

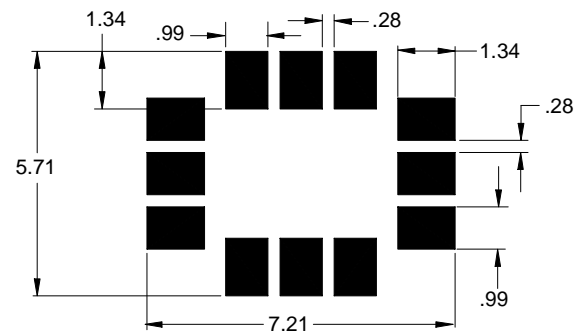
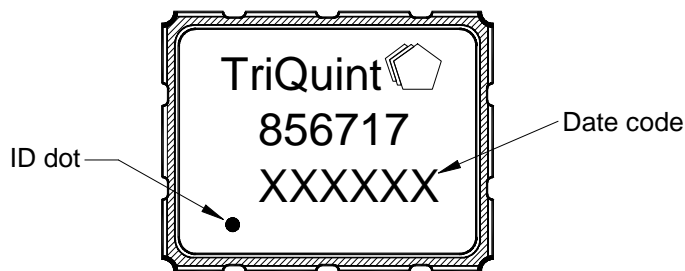

The date code consists of: day of the current year (Julian, 3 digits), last digit of the year (1 digit) and hour (2 digits)

This footprint represents a recommendation only
Dimensions shown are nominal in millimeters

Tape and Reel

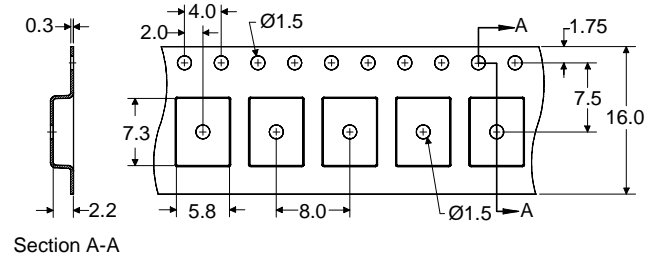
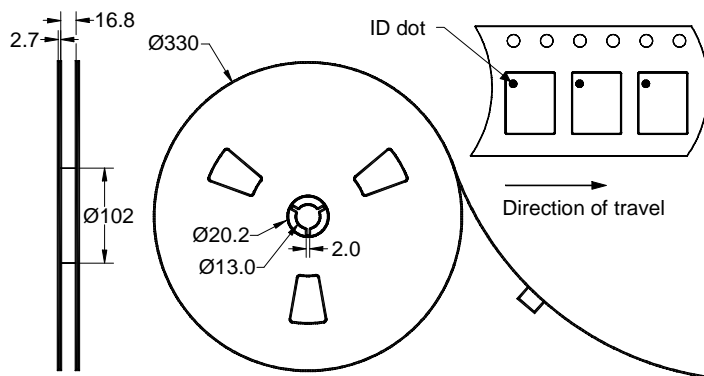

Dimensions shown are nominal in millimeters
Packaging quantity: 3000 units/reel

Maximum Ratings

Parameter	Symbol	Minimum	Maximum	Unit
Operating Temperature Range	T	-35	+85	°C
Storage Temperature Range	T _{stg}	-40	+85	°C

Important Notes

Warnings

- Electrostatic Sensitive Device (ESD) 
- Avoid ultrasonic exposure

RoHS Compliance

- This product complies with EU directive 2002/95/EC (RoHS) 

Solderability

- Compatible with JESD22-B102, Pb-free process, 260C peak reflow temperature ([see soldering profile](#))

Links to Additional Technical Information

[PCB Layout Tips](#)

[Qualification Flowchart](#)

[Soldering Profile](#)

[S-Parameters](#)

[RoHS Information](#)

[Other Technical Information](#)

TriQuint's liability is limited only to the Surface Acoustic Wave (SAW) component(s) described in this data sheet. TriQuint does not accept any liability for applications, processes, circuits or assemblies, which are implemented using any TriQuint component described in this data sheet.

Contact Information

TriQuint 
SEMICONDUCTOR

PO Box 609501
Orlando, FL 32860-9501
USA

Phone: +1 (407) 886-8860
Fax: +1 (407) 886-7061
Email: info-product@tqs.com
Web: www.triquint.com

Or contact one of our worldwide
Network of [sales offices](#),
[Representatives or distributors](#)