

Features

- For WCDMA Applications
- Usable Bandwidth of 19.2 MHz
- Low Loss
- High Attenuation
- Balanced Operation
- Ceramic Surface Mount Package (SMP)
- Hermetic
- RoHS compliant (2002/95/EC), Pb-free 

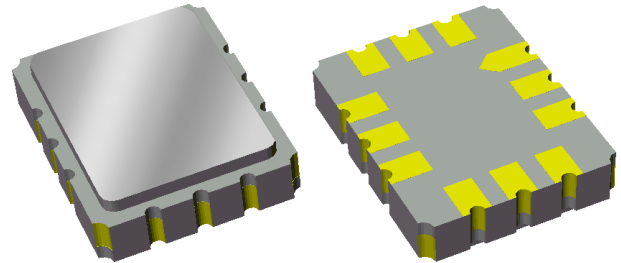

Package

Surface Mount 7.01 x 5.51 x 1.63 mm
SMP-28B

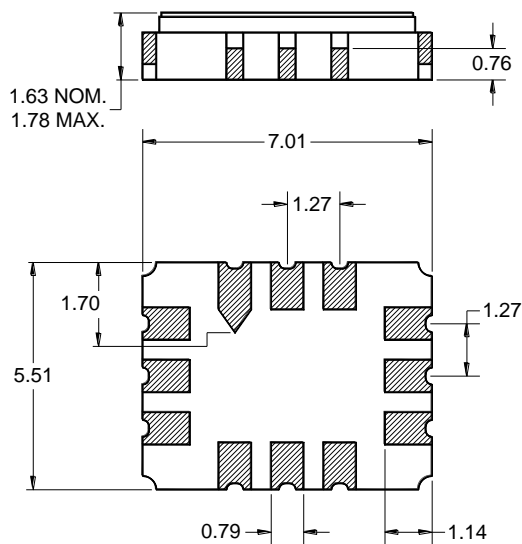

Dimensions shown are nominal in millimeters
All tolerances are ± 0.15 mm except overall
length and width ± 0.13 mm

Body: Al_2O_3 ceramic
Lid: Kovar, Ni plated
Terminations: Au plating 0.5 - 1.0 μ m,
over a 2 - 6 μ m Ni plating

Pin Configuration

Bottom View

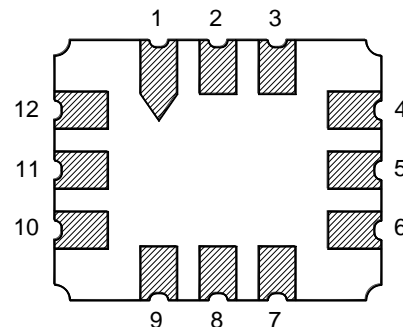

Pin No.	Description
10	Input +
12	Input -
4	Output +
6	Output -
1,2,3,5	Case Ground
7,8,9,11	Case Ground

Electrical Specifications ⁽¹⁾

Operating Temperature Range: ⁽²⁾ -33 to +85 °C

Parameter ⁽³⁾	Minimum	Typical ⁽⁴⁾	Maximum	Unit
Center Frequency	-	358.4	-	MHz
Insertion Loss at Center Frequency	-	10.1	12.5	dB
Lower 5 dB Bandedge ⁽⁵⁾	343.4	344.8	-	MHz
Upper 5 dB Bandedge ⁽⁵⁾	-	371.8	373.4	MHz
Amplitude Variation 348.8 – 368 MHz	-	0.3	1.0	dB p-p
Absolute Group Delay	-	470	600	ns
Group Delay Variation 348.8 – 368 MHz	-	25	60	ns p-p
Absolute Attenuation ⁽⁵⁾				
10.00 – 286.40 MHz	55	70	-	dB
286.40 – 307.40 MHz	55	62	-	dB
307.40 – 327.70 MHz	40	52	-	dB
327.70 – 335.40 MHz	30	51	-	dB
335.40 – 341.15 MHz	25	38	-	dB
341.15 – 341.65 MHz	20	31	-	dB
341.65 – 342.15 MHz	15	25	-	dB
342.15 – 342.90 MHz	10	17	-	dB
373.90 – 374.65 MHz	10	17	-	dB
374.65 – 375.15 MHz	15	25	-	dB
375.15 – 375.40 MHz	20	32	-	dB
375.40 – 381.40 MHz	25	37	-	dB
381.40 – 389.10 MHz	30	49	-	dB
389.10 – 409.40 MHz	40	51	-	dB
409.40 – 430.40 MHz	55	64	-	dB
430.40 – 640.00 MHz	55	66	-	dB
640.00 – 720.00 MHz	50	55	-	dB
720.00 – 1000 MHz	55	70	-	dB
Time Side-lobe Response Attenuation (1.0 – 500 μs)	40	48	-	dB
Source Impedance Balanced ⁽⁶⁾	-	200	-	Ω
Load Impedance Balanced ⁽⁶⁾	-	200	-	Ω

Notes:

1. All specifications are based on the TriQuint test circuit shown on page 4
2. In production, devices will be tested at room temperature to a guardbanded specification to ensure electrical compliance over temperature
3. Electrical margin has been built into the design to account for the variations due to temperature drift and manufacturing tolerances
4. Typical values are based on average measurements at room temperature
5. Relative to insertion loss at center frequency
6. This is the optimum impedance in order to achieve the performance shown

Typical Performance (at room temperature)

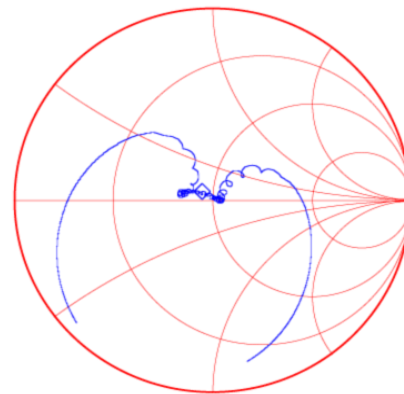
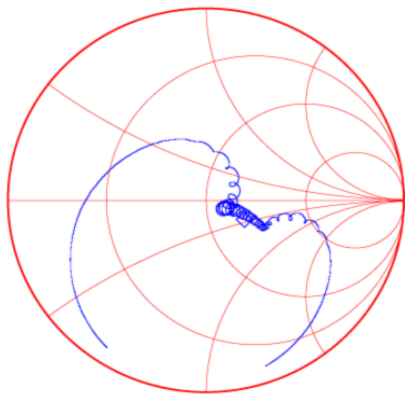
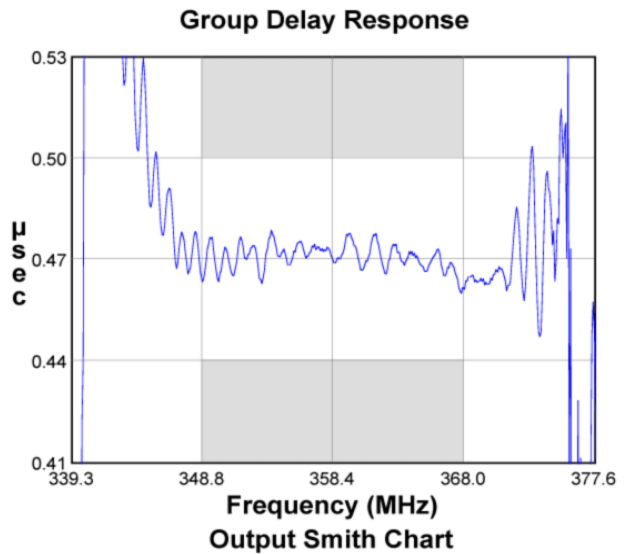
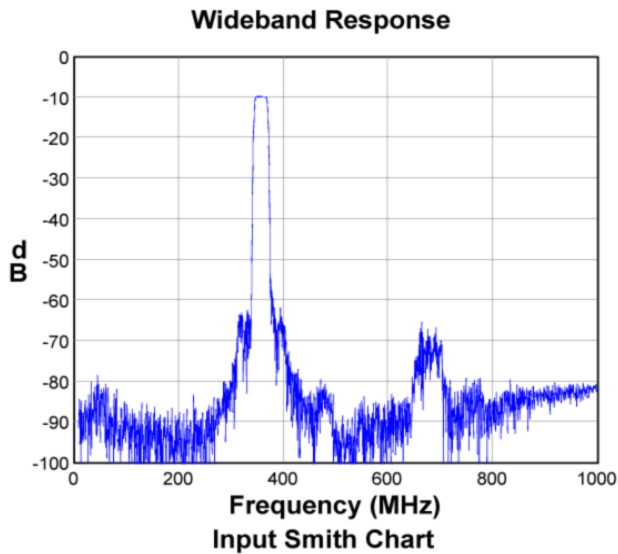
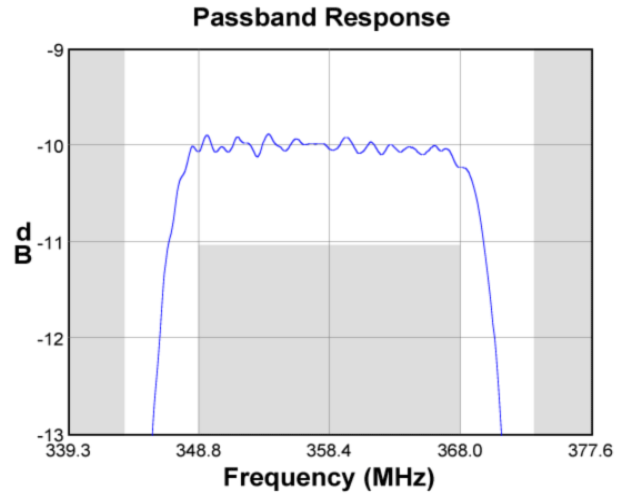
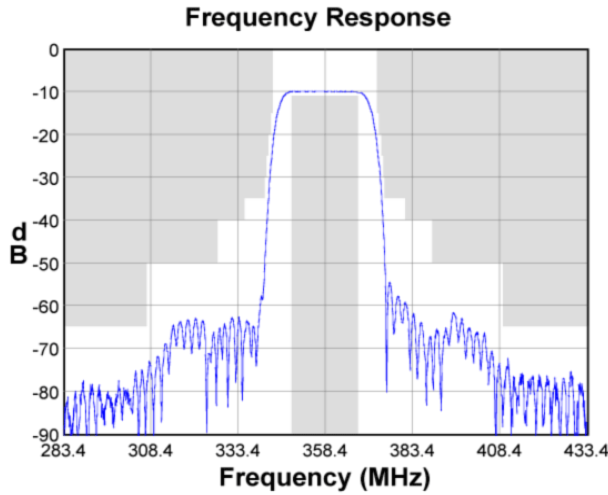

Matching Schematics

Actual matching values may vary due to PCB layout and parasitics

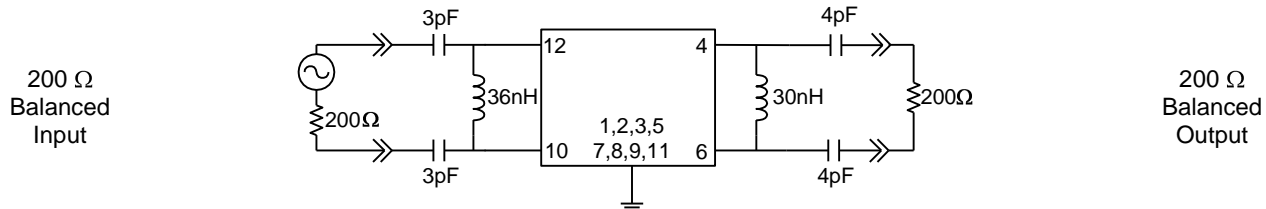

Marking

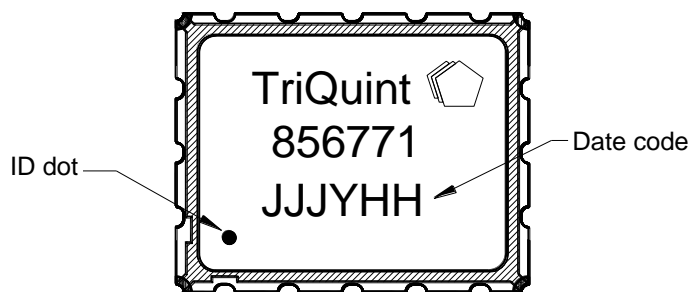

PCB Footprint

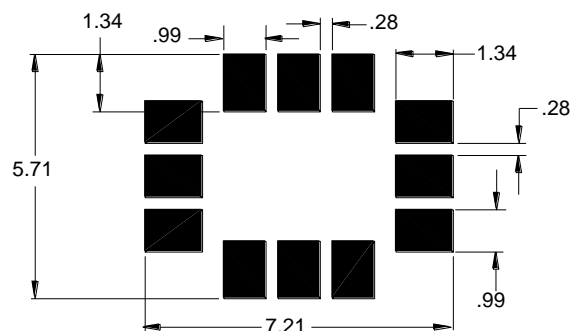

The date code consists of: day of the current year (Julian, 3 digits), Y=last digit of the year (1 digit) and H=military hour (2 digits)

This footprint represents a recommendation only
Dimensions shown are nominal in millimeters

Tape and Reel

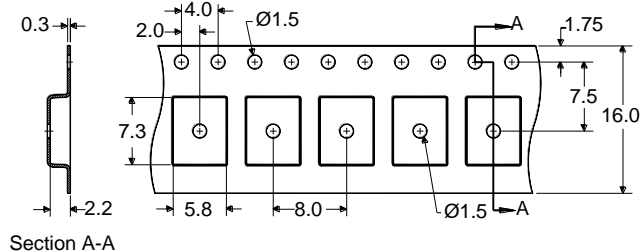
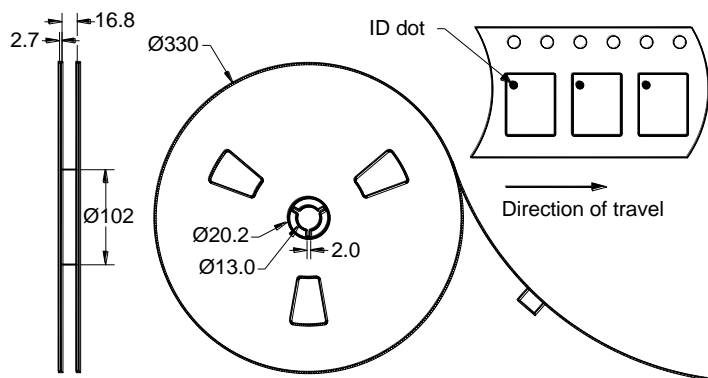

Dimensions shown are nominal in millimeters
Packaging quantity: 3000 units/reel

Maximum Ratings

Parameter	Symbol	Minimum	Maximum	Unit
Operating Temperature Range	T	-33	+85	°C
Storage Temperature Range	T _{stg}	-40	+85	°C
Input Power (at +50°C for 24 hours max)	P _{in}	-	+19	dBm

Important Notes

Warnings

- Electrostatic Sensitive Device (ESD) 
- Avoid ultrasonic exposure

RoHS Compliance

- This product complies with EU directive 2002/95/EC (RoHS) 

Solderability

- Compatible with JESD22-B102, Pb-free process, 260C peak reflow temperature ([see soldering profile](#))

Links to Additional Technical Information

[PCB Layout Tips](#)

[Qualification Flowchart](#)

[Soldering Profile](#)

[S-Parameters](#)

[RoHS Information](#)

[Other Technical Information](#)

TriQuint's liability is limited only to the Surface Acoustic Wave (SAW) component(s) described in this data sheet. TriQuint does not accept any liability for applications, processes, circuits or assemblies, which are implemented using any TriQuint component described in this data sheet.

Contact Information

TriQuint 
SEMICONDUCTOR

PO Box 609501
Orlando, FL 32860-9501
USA

Phone: +1 (407) 886-8860
Fax: +1 (407) 886-7061
Email: info-product@tqs.com
Web: www.triquint.com

Or contact one of our worldwide
Network of [sales offices](#),
[Representatives or distributors](#)