

7 Watt Ka-Band HPA

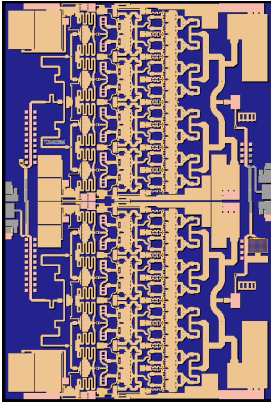

Measured Performance

Bias conditions: $V_d = 6\text{ V}$, $I_{dq} = 3200\text{ mA}$, $V_g = -0.7\text{ V}$
Typical

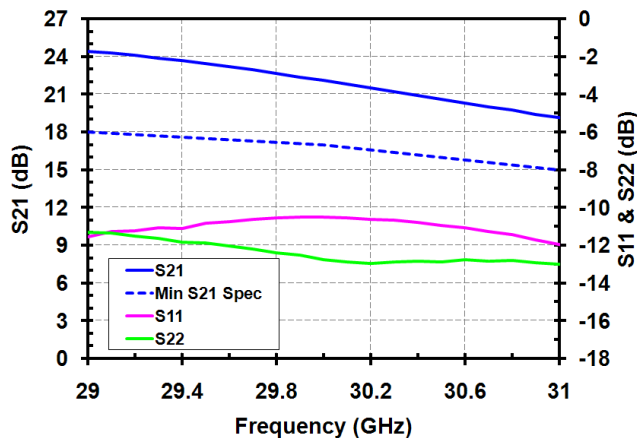
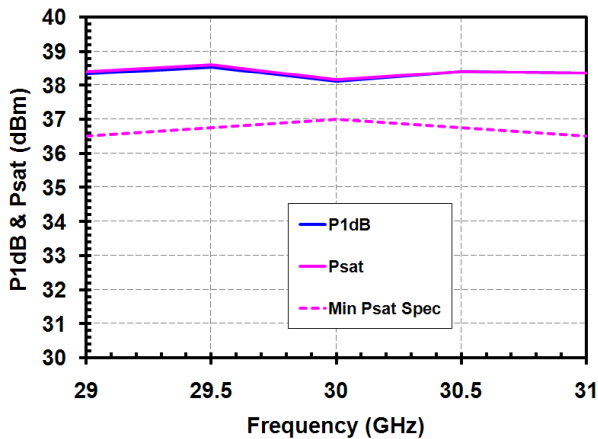

Key Features

- Frequency Range: 29 - 31 GHz
- 38.5 dBm Nominal Psat, 38 dBm Nominal P1dB
- Gain: 21 dB
- Return Losses: -10 dB
- Bias: $V_d = 6\text{ V}$, $I_{dq} = 3.2\text{ A}$, $V_g = -0.7\text{ V}$
Typical, I_d under RF drive = 6 A
- Technology: 3MI 0.15 μm Power pHEMT
- Chip Dimensions: 3.86 x 5.71 x 0.05 mm

Primary Application

- Ka-Band VSAT

Product Description

The TriQuint TGA4916 is a compact 7 Watt High Power Amplifier for Ka-band applications. The part is designed using TriQuint's proven standard 0.15 μm gate Power pHEMT production process. The TGA4916 provides a nominal 38.5 dBm of output power at an input power level of 19 dBm with a small signal gain of 21 dB.

The part is ideally suited for low cost emerging markets such as base station transmitters for satellite ground terminals and point to point radio.

Datasheet subject to change without notice.

Table I
Absolute Maximum Ratings 1/

Symbol	Parameter	Value	Notes
Vd-Vg	Drain to Gate Voltage	11 V	
Vd	Drain Voltage	6.5 V	2/
Vg	Gate Voltage Range	-5 to 0 V	
Id	Drain Current	6760 mA	2/
Ig	Gate Current Range	-31 to 403 mA	
Pin	Input Continuous Wave Power	29 dBm	2/
Tchannel	Channel Temperature	200 °C	

- 1/ These ratings represent the maximum operable values for this device. Stresses beyond those listed under “Absolute Maximum Ratings” may cause permanent damage to the device and/or affect device lifetime. These are stress ratings only, and functional operation of the device at these conditions is not implied.
- 2/ Combinations of supply voltage, supply current, input power, and output power shall not exceed the maximum power dissipation listed in Table IV.

Table II
Recommended Operating Conditions

Symbol	Parameter 1/	Value
Vd	Drain Voltage	6 V
Idq	Drain Current	3200 mA
Id_Drive	Drain Current under RF Drive	5700 mA
Vg	Gate Voltage	-0.7 V

- 1/ See assembly diagram for bias instructions.

**Table III
RF Characterization Table**

Bias: Vd = 6 V, Idq = 3200 mA, Vg = -0.7 V, typical

SYMBOL	PARAMETER	TEST CONDITIONS	MINIMUM	NOMINAL	UNITS
Gain	Small Signal Gain	f = 29 GHz	18	21	dB
		f = 30 GHz	17	21	
		f = 31 GHz	15	19	
IRL	Input Return Loss	f = 29 - 31 GHz	-	-10	dB
ORL	Output Return Loss	f = 29 - 31 GHz	-	-12	dB
Psat	Saturated Output Power	f = 29 GHz	36.5	38.5	dBm
		f = 30 GHz	37.0	38.5	
		f = 31 GHz	36.5	38.5	
P1dB	Output Power @ 1dB Compression	f = 29 - 31 GHz	-	38	dBm
	Gain Temp Coefficient	f = 29 - 31 GHz	-	-0.05	dB / °C

Table IV
Power Dissipation and Thermal Properties

Parameter	Test Conditions	Value	Notes
Maximum Power Dissipation	Tbaseplate = 70 °C	Pd = 41.45 W Tchannel = 150 °C Tm = 1E+6 Hrs	1/ 2/
Thermal Resistance, θ_{jc}	Vd = 6 V Id = 3200 mA Pd = 19.2 W Tbaseplate = 70 °C	θ_{jc} = 1.93 (°C/W) Tchannel = 108 °C Tm = 1.8E+8 Hrs	
Thermal Resistance, θ_{jc} Under RF Drive	Vd = 6 V Id = 6200 mA Pout = 38 dBm Pd = 30.97 W Tbaseplate = 70 °C	θ_{jc} = 1.93 (°C/W) Tchannel = 130 °C Tm = 2E+7 Hrs	
Mounting Temperature	30 Seconds	320 °C	
Storage Temperature		-65 to 150 °C	

- 1/ For a median life of 1E+6 hours, Power Dissipation is limited to

$$Pd(max) = (150\text{ °C} - Tbase\text{ °C})/\theta_{jc}.$$
- 2/ Channel operating temperature will directly affect the device median time to failure (MTTF). For maximum life, it is recommended that channel temperatures be maintained at the lowest possible levels.

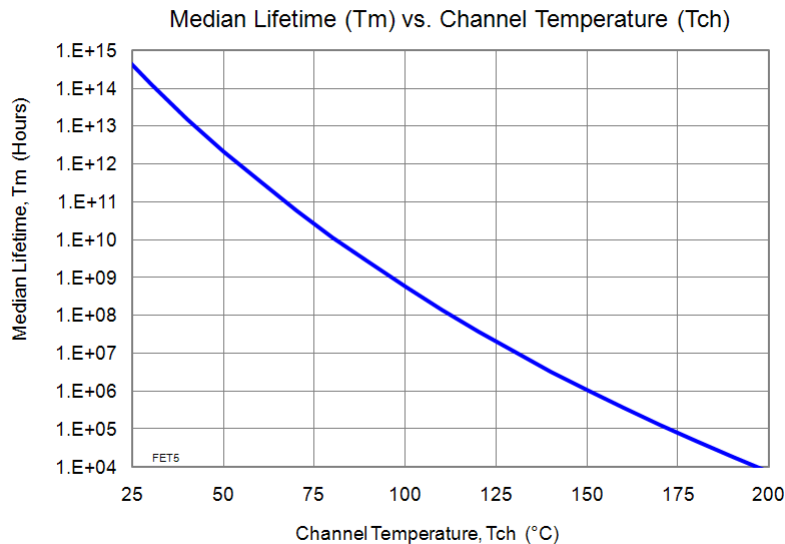

Measured Data

Bias conditions: $V_d = 6\text{ V}$, $I_{dq} = 3200\text{ mA}$, $V_g = -0.7\text{ V}$ Typical

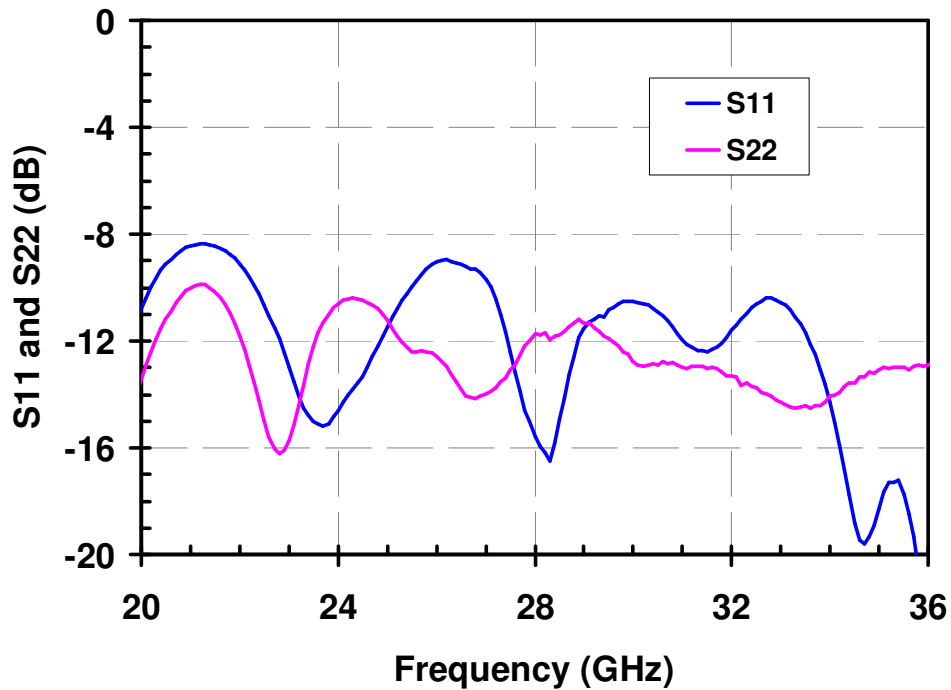
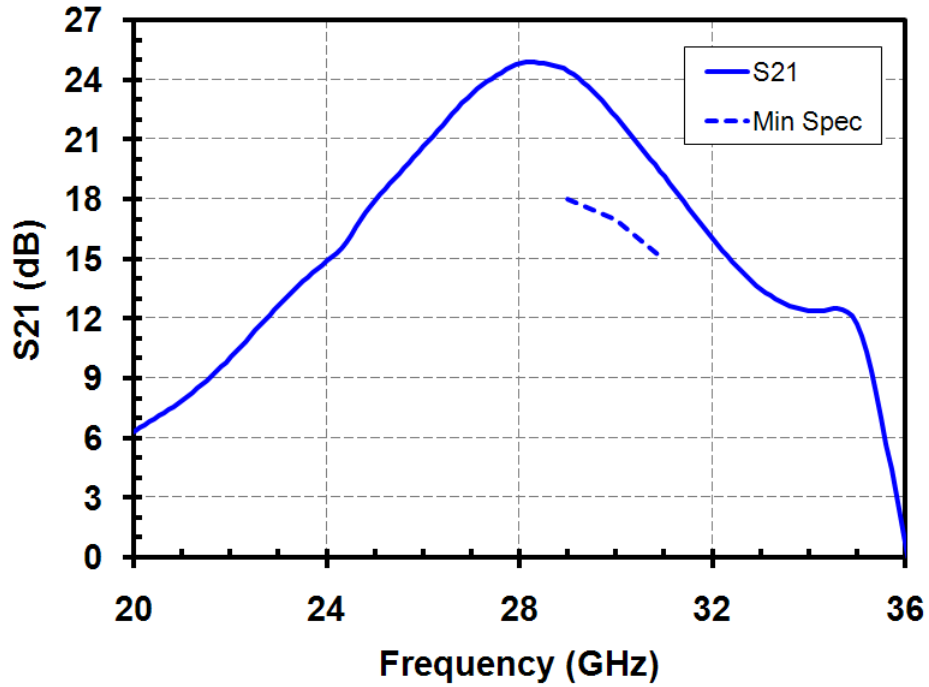

Measured Data

Bias conditions: $V_d = 6\text{ V}$, $I_{dq} = 3200\text{ mA}$, $V_g = -0.7\text{ V}$ Typical

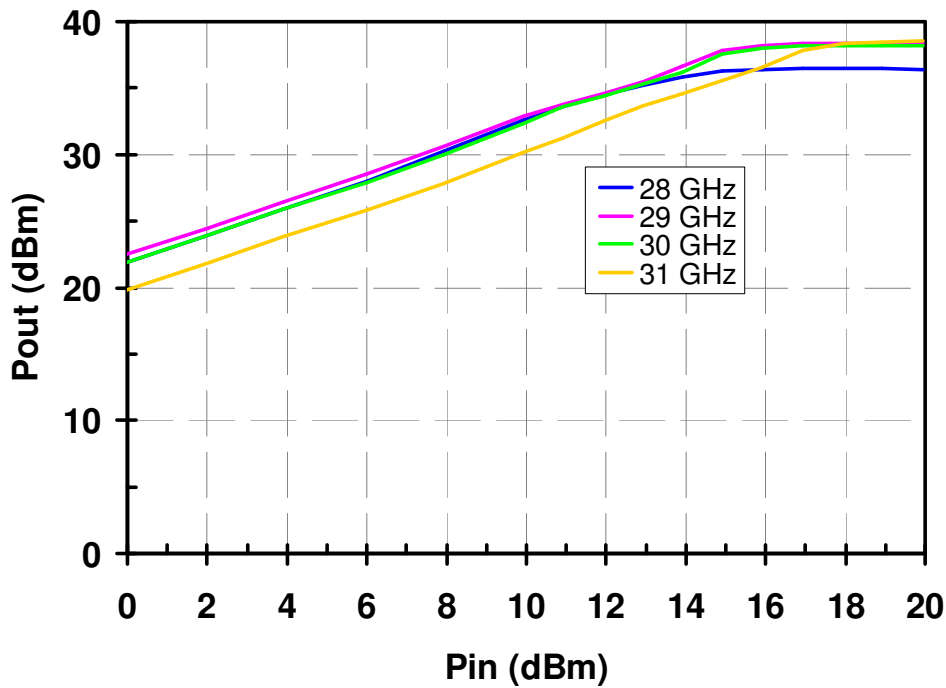
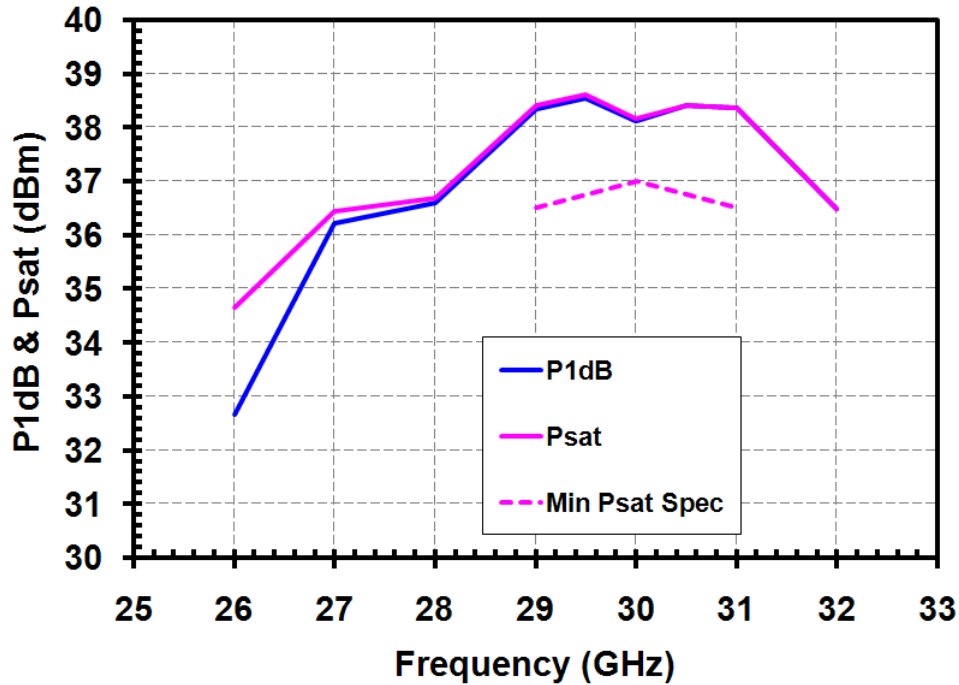

Measured Data

Bias conditions: $V_d = 6\text{ V}$, $I_{dQ} = 3200\text{ mA}$, $V_g = -0.7\text{ V}$ Typical

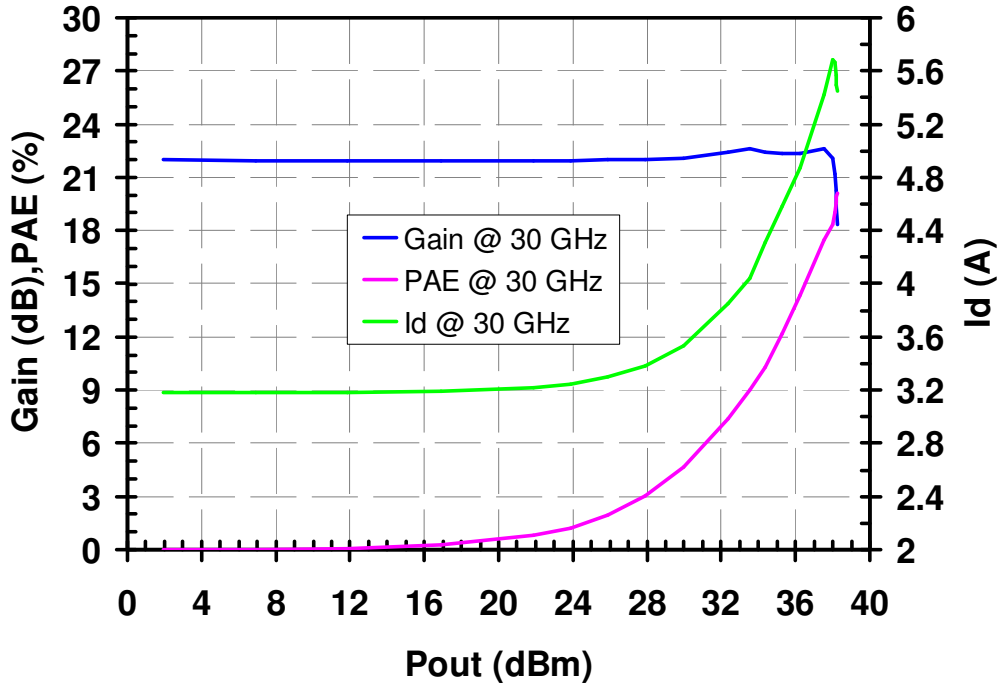

Measured Data

Bias conditions: $V_d = 6\text{ V}$, $I_{dq} = 3200\text{ mA}$, $V_g = -0.7\text{ V}$ Typical

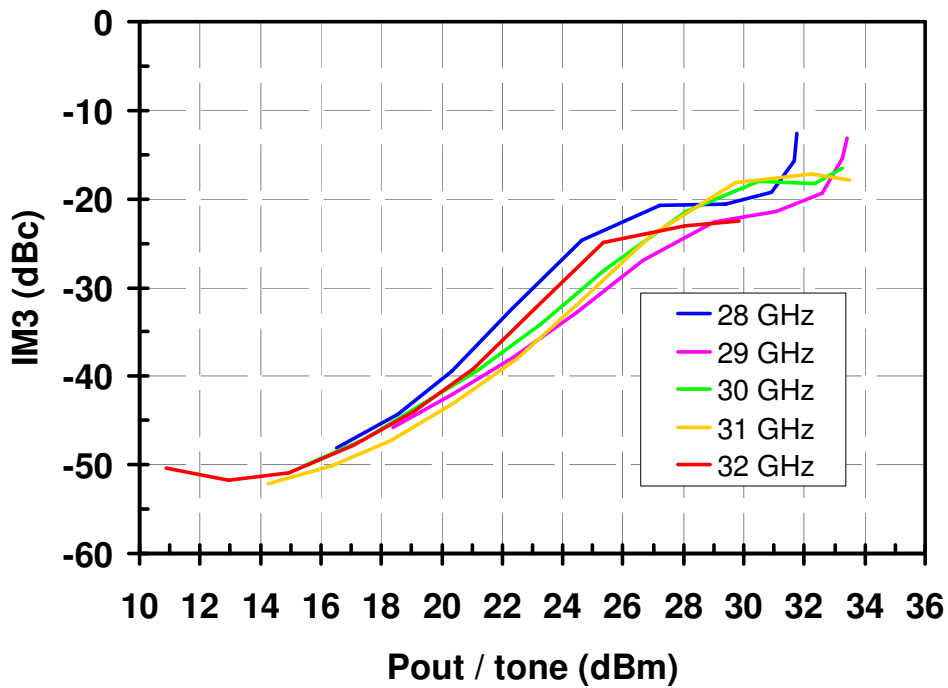
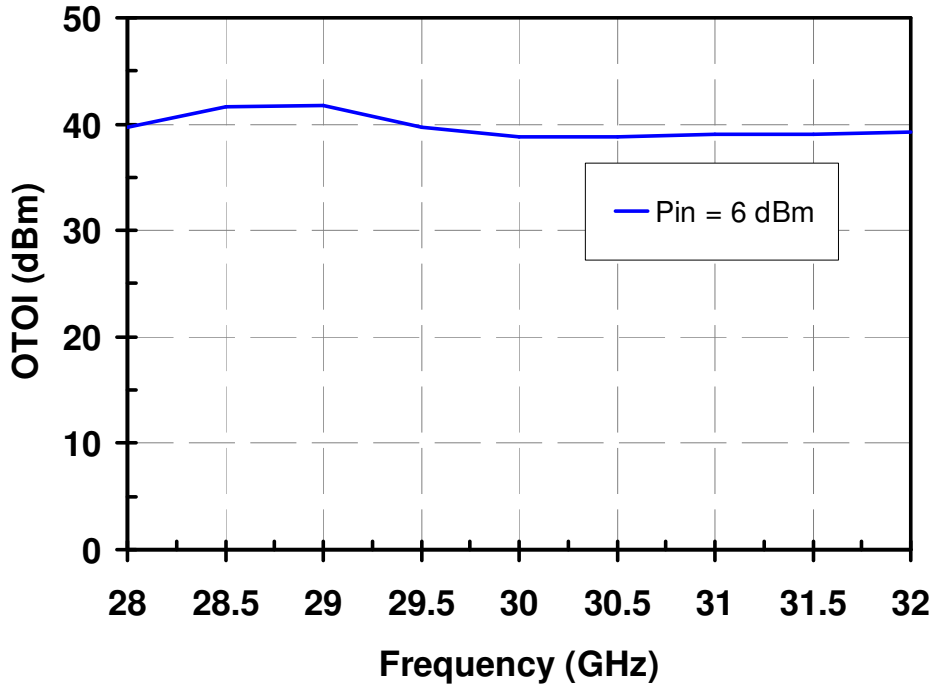

Electrical Schematic

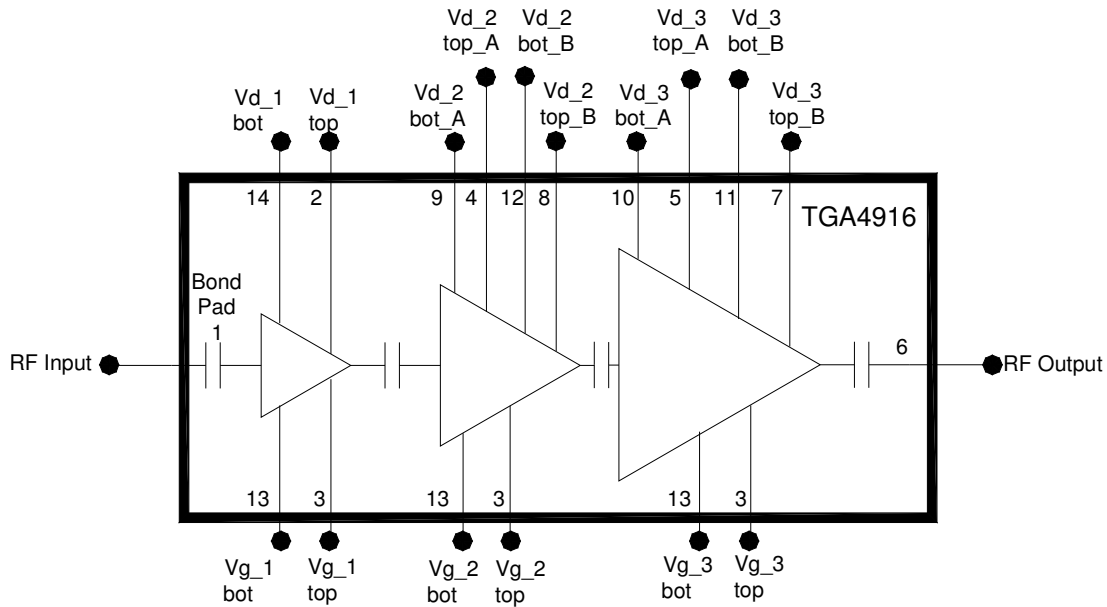

Bias Procedures

Bias-up Procedure

Vg set to -1.5 V

Vd_top set to +6 V

Vd_bottom set to +6 V

Adjust Vg more positive until Idq is 3200 mA.
This will be ~ Vg = -0.72 V

Apply RF signal to input

Bias-down Procedure

Turn off RF supply

Reduce Vg to -1.5V. Ensure Idq ~ 0 mA

Turn Vd_top to 0 V

Turn Vd_bottom to 0 V

Turn Vg to 0 V

Mechanical Drawing

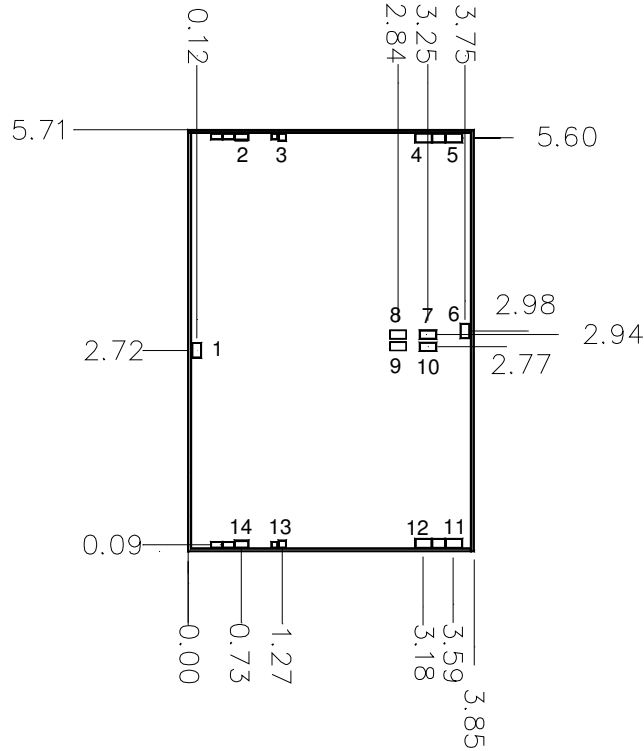

Units: millimeters

Thickness: 0.05

Die x,y size tolerance: +/- 0.050

Chip edge to bond pad dimensions are shown to center of pad

Ground is backside of die

Bond Pad #1	RF Input	0.125 x 0.20	Bond Pad #8	Vd_2_top_B	0.225 x 0.115
Bond Pad #2	Vd_1_top	0.187 x 0.10	Bond Pad #9	Vd_2_bot_A	0.225 x 0.115
Bond Pad #3	Vg_1,2,3_top	0.10 x 0.10	Bond Pad #10	Vd_3_bot_A	0.225 x 0.115
Bond Pad #4	Vd_2_top_A	0.225 x 0.125	Bond Pad #11	Vd_3_bot_B	0.225 x 0.125
Bond Pad #5	Vd_3_top_A	0.225 x 0.125	Bond Pad #12	Vd_2_bot_B	0.225 x 0.125
Bond Pad #6	RF Output	0.125 x 0.20	Bond Pad #13	Vg_1,2,3_bot	0.10 x 0.10
Bond Pad #7	Vd_3_top_B	0.225 x 0.115	Bond Pad #14	Vd_1_bot	0.187 x 0.10

GaAs MMIC devices are susceptible to damage from Electrostatic Discharge. Proper precautions should be observed during handling, assembly and test.

Recommended Assembly Diagram

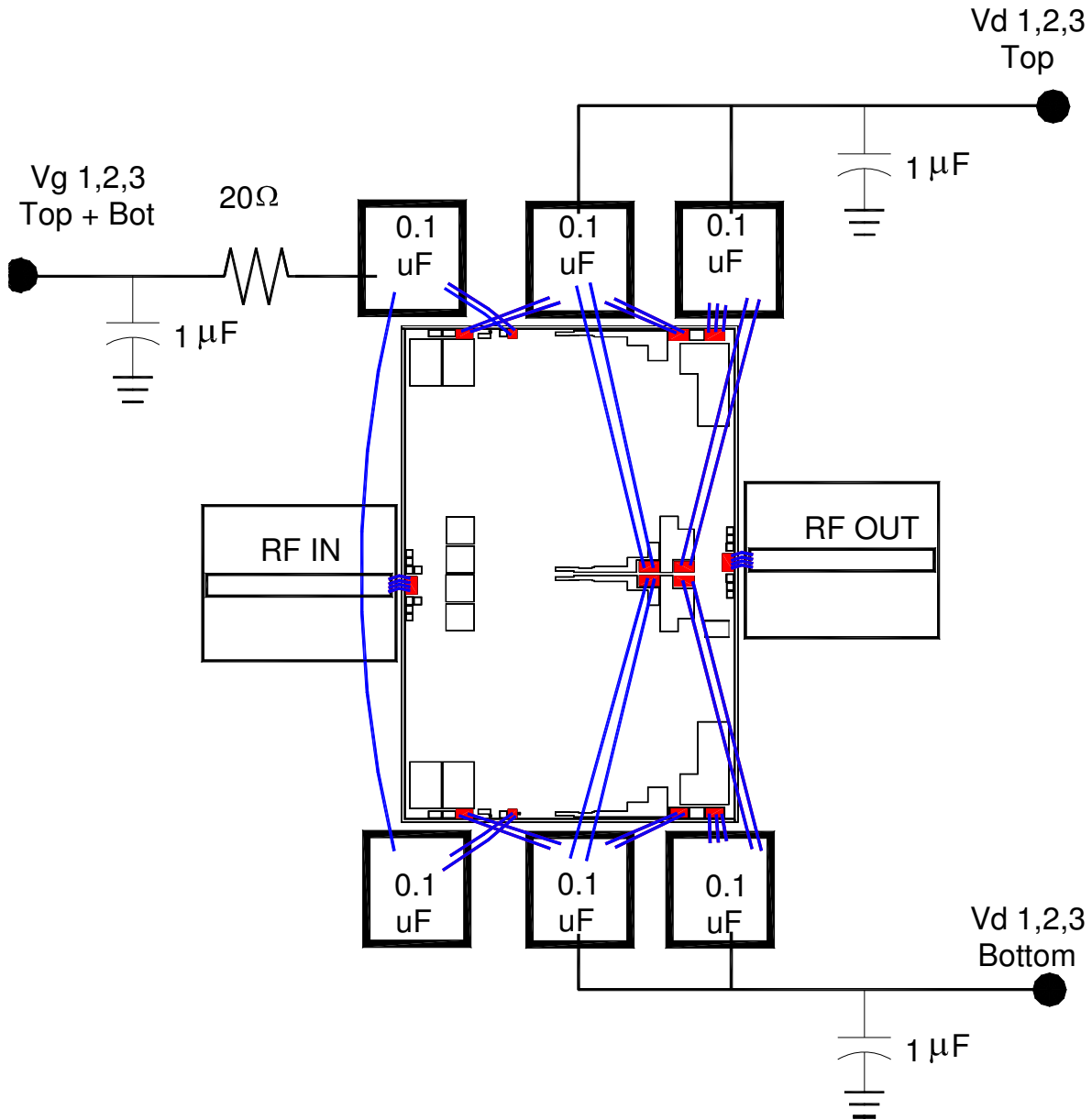

- 1/ Bond only to hatched bond pads, designated in blue. Bonding to other areas may damage MMIC.
- 2/ For optimal performance, RF Input and RF Output should be bonded with 4 wires, using wedge bonding, or a gold ribbon. Alternatively, 3 ball bonds can be used.
- 3/ All DC connections from 0.1 uF decoupling caps to chip should have 2 bonds.

GaAs MMIC devices are susceptible to damage from Electrostatic Discharge. Proper precautions should be observed during handling, assembly and test.

Assembly Notes

Component placement and adhesive attachment assembly notes:

- Vacuum pencils and/or vacuum collets are the preferred method of pick up.
- Air bridges must be avoided during placement.
- The force impact is critical during auto placement.
- Organic attachment (i.e. epoxy) can be used in low-power applications.
- Curing should be done in a convection oven; proper exhaust is a safety concern.

Reflow process assembly notes:

- Use AuSn (80/20) solder and limit exposure to temperatures above 300°C to 3-4 minutes, maximum.
- An alloy station or conveyor furnace with reducing atmosphere should be used.
- Do not use any kind of flux.
- Coefficient of thermal expansion matching is critical for long-term reliability.
- Devices must be stored in a dry nitrogen atmosphere.

Interconnect process assembly notes:

- Ball bonding is the preferred interconnect technique, except where noted on the assembly diagram.
- Force, time, and ultrasonics are critical bonding parameters.
- Aluminum wire should not be used.
- Devices with small pad sizes should be bonded with 0.0007-inch wire.

Ordering Information

Part	Package Style
TGA4916	GaAs MMIC Die

GaAs MMIC devices are susceptible to damage from Electrostatic Discharge. Proper precautions should be observed during handling, assembly and test.