

ADG728/ADG729

FEATURES

- 2-Wire Serial Interface
- 2.7 V to 5.5 V Single Supply
- 2.5 Ω On Resistance
- 0.75 Ω On-Resistance Flatness
- 100 pA Leakage Currents
- Single 8-to-1 Matrix Switch ADG728
- Dual 4-to-1 Matrix Switch ADG729
- Power-On Reset
- Small 16-Lead TSSOP Package

APPLICATIONS

- Data Acquisition Systems
- Communication Systems
- Relay Replacement
- Audio and Video Switching
- Automatic Test Equipment

FUNCTIONAL BLOCK DIAGRAMS

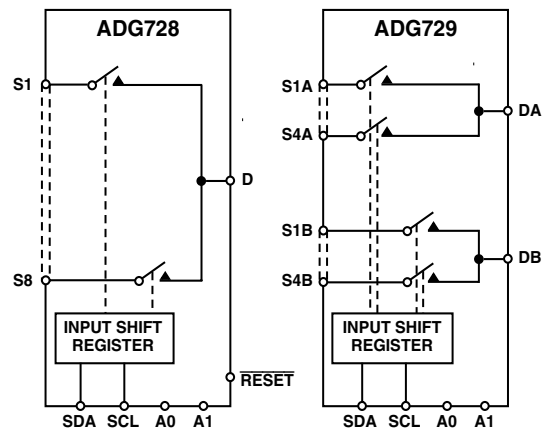

GENERAL DESCRIPTION

The ADG728 and ADG729 are CMOS analog matrix switches with a serially controlled 2-wire interface. The ADG728 is an 8-channel matrix switch, while the ADG729 is a dual 4-channel matrix switch. On resistance is closely matched between switches and very flat over the full signal range. These parts can operate equally well as either multiplexers, demultiplexers or switch arrays and the input signal range extends to the supplies.

The ADG728 and ADG729 utilize a 2-wire serial interface that is compatible with the I²C™ interface standard. Both have two external address pins (A0 and A1). This allows the 2 LSBs of the 7-bit slave address to be set by the user. Four of each of the devices can be connected to the one bus. The ADG728 also has a $\overline{\text{RESET}}$ pin that should be tied high if not in use.

Each channel is controlled by one bit of an 8-bit word. This means that these devices may be used in a number of different configurations; all, any, or none of the channels may be on at any one time.

On power-up of the device, all switches will be in the OFF condition and the internal shift register will contain all zeros.

All channels exhibit break-before-make switching action preventing momentary shorting when switching channels.

The ADG728 and ADG729 are available in 16-lead TSSOP packages.

PRODUCT HIGHLIGHTS

1. 2-Wire Serial Interface.
2. Single Supply Operation. The ADG728 and ADG729 are fully specified and guaranteed with 3 V and 5 V supply rails.
3. Low On Resistance 2.5 Ω typical.
4. Any configuration of switches may be on at any one time.
5. Guaranteed Break-Before-Make Switching Action.
6. Small 16-Lead TSSOP Package.

I²C is a trademark of Philips Corporation.

REV. A

Information furnished by Analog Devices is believed to be accurate and reliable. However, no responsibility is assumed by Analog Devices for its use, nor for any infringements of patents or other rights of third parties which may result from its use. No license is granted by implication or otherwise under any patent or patent rights of Analog Devices.

ADG728/ADG729—SPECIFICATIONS¹ ($V_{DD} = 5\text{ V} \pm 10\%$, $GND = 0\text{ V}$, unless otherwise noted.)

Parameter	B Version		Unit	Test Conditions/Comments
	25°C	-40°C to +85°C		
ANALOG SWITCH				
Analog Signal Range		0 V to V_{DD}	V	
On Resistance (R_{ON})	2.5 4.5	5	Ω typ Ω max	$V_S = 0\text{ V}$ to V_{DD} , $I_S = 10\text{ mA}$; Test Circuit 1
On-Resistance Match Between Channels (ΔR_{ON})		0.4 0.8	Ω typ Ω max	$V_S = 0\text{ V}$ to V_{DD} , $I_S = 10\text{ mA}$
On-Resistance Flatness ($R_{FLAT(ON)}$)	0.75	1.2	Ω typ Ω max	$V_S = 0\text{ V}$ to V_{DD} , $I_S = 10\text{ mA}$
LEAKAGE CURRENTS				
Source OFF Leakage I_S (OFF)	± 0.01 ± 0.1	± 0.3	nA typ nA max	$V_{DD} = 5.5\text{ V}$ $V_D = 4.5\text{ V}/1\text{ V}$, $V_S = 1\text{ V}/4.5\text{ V}$, Test Circuit 2
Drain OFF Leakage I_D (OFF)	± 0.01 ± 0.1	± 1	nA typ nA max	$V_D = 4.5\text{ V}/1\text{ V}$, $V_D = 1\text{ V}/4.5\text{ V}$, Test Circuit 3
Channel ON Leakage I_D , I_S (ON)	± 0.01 ± 0.1	± 1	nA typ nA max	$V_D = V_S = 4.5\text{ V}/1\text{ V}$, Test Circuit 4
LOGIC INPUTS (A0, A1)²				
Input High Voltage, V_{INH}		2.4	V min	
Input Low Voltage, V_{INL}		0.8	V max	
Input Current I_{INL} or I_{INH}	0.005	± 0.1	μA typ μA max	
C_{IN} , Input Capacitance	6		pF typ	
LOGIC INPUTS (SCL, SDA)²				
Input High Voltage, V_{INH}		0.7 V_{DD} $V_{DD} + 0.3$	V min V max	
Input Low Voltage, V_{INL}		-0.3 0.3 V_{DD}	V min V max	
I_{IN} , Input Leakage Current	0.005	± 1.0	μA typ μA max	$V_{IN} = 0\text{ V}$ to V_{DD}
V_{HYST} , Input Hysteresis C_{IN} , Input Capacitance	0.05 V_{DD} 6		V min pF typ	
LOGIC OUTPUT (SDA)²				
V_{OL} , Output Low Voltage		0.4 0.6	V max V max	$I_{SINK} = 3\text{ mA}$ $I_{SINK} = 6\text{ mA}$
DYNAMIC CHARACTERISTICS²				
t_{ON}	95	140	ns typ ns max	$R_L = 300\ \Omega$, $C_L = 35\text{ pF}$, Test Circuit 5; $V_{S1} = 3\text{ V}$
t_{OFF}	85	130	ns typ ns max	$V_{S1} = 3\text{ V}$, $R_L = 300\ \Omega$, $C_L = 35\text{ pF}$; Test Circuit 5
Break-Before-Make Time Delay, t_D	8	1	ns typ ns min	$R_L = 300\ \Omega$, $C_L = 35\text{ pF}$; $V_{S1} = V_{S2} = 3\text{ V}$, Test Circuit 5
Charge Injection	± 3		pC typ	$V_S = 2.5\text{ V}$, $R_S = 0\ \Omega$, $C_L = 1\text{ nF}$; Test Circuit 6
Off Isolation	-55 -75		dB typ dB typ	$R_L = 50\ \Omega$, $C_L = 5\text{ pF}$, $f = 10\text{ MHz}$; $R_L = 50\ \Omega$, $C_L = 5\text{ pF}$, $f = 1\text{ MHz}$; Test Circuit 8
Channel-to-Channel Crosstalk	-55 -75		dB typ dB typ	$R_L = 50\ \Omega$, $C_L = 5\text{ pF}$, $f = 10\text{ MHz}$; $R_L = 50\ \Omega$, $C_L = 5\text{ pF}$, $f = 1\text{ MHz}$; Test Circuit 7
-3 dB Bandwidth				
ADG728	65		MHz typ	$R_L = 50\ \Omega$, $C_L = 5\text{ pF}$, Test Circuit 8
ADG729	100		MHz typ	
C_S (OFF)	13		pF typ	
C_D (OFF)				
ADG728	85		pF typ	
ADG729	42		pF typ	
C_D , C_S (ON)				
ADG728	96		pF typ	
ADG729	48		pF typ	
POWER REQUIREMENTS				
I_{DD}	10	20	μA typ μA max	$V_{DD} = 5.5\text{ V}$ Digital Inputs = 0 V or 5.5 V

NOTES

¹Temperature range is as follows: B Version: -40°C to +85°C.

²Guaranteed by design, not subject to production test.

Specifications subject to change without notice.

SPECIFICATIONS¹ ($V_{DD} = 3\text{ V} \pm 10\%$, $GND = 0\text{ V}$, unless otherwise noted.)

Parameter	B Version		Unit	Test Conditions/Comments
	25°C	-40°C to +85°C		
ANALOG SWITCH				
Analog Signal Range		0 V to V_{DD}	V	
On Resistance (R_{ON})	6		Ω typ	$V_S = 0\text{ V to }V_{DD}$, $I_S = 10\text{ mA}$;
	11	12	Ω max	Test Circuit 1
On-Resistance Match Between Channels (ΔR_{ON})		0.4	Ω typ	$V_S = 0\text{ V to }V_{DD}$, $I_S = 10\text{ mA}$
On-Resistance Flatness ($R_{FLAT(ON)}$)		1.2	Ω max	
		3.5	Ω typ	$V_S = 0\text{ V to }V_{DD}$, $I_S = 10\text{ mA}$
LEAKAGE CURRENTS				
Source OFF Leakage I_S (OFF)	± 0.01		nA typ	$V_{DD} = 3.3\text{ V}$
	± 0.1	± 0.3	nA max	$V_S = 3\text{ V}/1\text{ V}$, $V_D = 1\text{ V}/3\text{ V}$, Test Circuit 2
Drain OFF Leakage I_D (OFF)	± 0.01		nA typ	$V_D = 3\text{ V}/1\text{ V}$, $V_S = 1\text{ V}/3\text{ V}$, Test Circuit 3
	± 0.1	± 1	nA max	
Channel ON Leakage I_D , I_S (ON)	± 0.01		nA typ	$V_D = V_S = 3\text{ V}/1\text{ V}$, Test Circuit 4
	± 0.1	± 1	nA max	
LOGIC INPUTS (A0, A1)²				
Input High Voltage, V_{INH}		2.0	V min	
Input Low Voltage, V_{INL}		0.4	V max	
Input Current				
I_{INL} or I_{INH}	0.005		μA typ	
		± 0.1	μA max	
C_{IN} , Input Capacitance	3		pF typ	
LOGIC INPUTS (SCL, SDA)²				
Input High Voltage, V_{INH}		0.7 V_{DD}	V min	
		$V_{DD} + 0.3$	V max	
Input Low Voltage, V_{INL}		-0.3	V min	
		0.3 V_{DD}	V max	
I_{IN} , Input Leakage Current	0.005		μA typ	$V_{IN} = 0\text{ V to }V_{DD}$
		± 1.0	μA max	
V_{HYST} , Input Hysteresis	0.05 V_{DD}		V min	
C_{IN} , Input Capacitance	3		pF typ	
LOGIC OUTPUT (SDA)²				
V_{OL} , Output Low Voltage		0.4	V max	$I_{SINK} = 3\text{ mA}$
		0.6	V max	$I_{SINK} = 6\text{ mA}$
DYNAMIC CHARACTERISTICS²				
t_{ON}	130		ns typ	$R_L = 300\ \Omega$, $C_L = 35\text{ pF}$, Test Circuit 5;
		200	ns max	$V_{S1} = 2\text{ V}$
t_{OFF}	115		ns typ	$R_L = 300\ \Omega$, $C_L = 35\text{ pF}$;
		180	ns max	$V_S = 2\text{ V}$, Test Circuit 5
Break-Before-Make Time Delay, t_D	8		ns typ	$R_L = 300\ \Omega$, $C_L = 35\text{ pF}$;
		1	ns min	$V_{S1} = V_{S8} = 2\text{ V}$, Test Circuit 5
Charge Injection	± 3		pC typ	$V_S = 1.5\text{ V}$, $R_S = 0\ \Omega$, $C_L = 1\text{ nF}$;
				Test Circuit 6
Off Isolation	-55		dB typ	$R_L = 50\ \Omega$, $C_L = 5\text{ pF}$, $f = 10\text{ MHz}$;
	-75		dB typ	$R_L = 50\ \Omega$, $C_L = 5\text{ pF}$, $f = 1\text{ MHz}$;
				Test Circuit 8
Crosstalk	-55		dB typ	$R_L = 50\ \Omega$, $C_L = 5\text{ pF}$, $f = 10\text{ MHz}$;
	-75		dB typ	$R_L = 50\ \Omega$, $C_L = 5\text{ pF}$, $f = 1\text{ MHz}$;
				Test Circuit 7
-3 dB Bandwidth				
ADG728	65		MHz typ	$R_L = 50\ \Omega$, $C_L = 5\text{ pF}$, Test Circuit 8
ADG729	100		MHz typ	
C_S (OFF)	13		pF typ	
C_D (OFF)				
ADG728	85		pF typ	
ADG729	42		pF typ	
C_D , C_S (ON)				
ADG728	96		pF typ	
ADG729	48		pF typ	
POWER REQUIREMENTS				
I_{DD}	10		μA typ	$V_{DD} = 3.3\text{ V}$
		20	μA max	Digital Inputs = 0 V or 3.3 V

NOTES

¹Temperature ranges are as follows: B Versions: -40°C to +85°C.²Guaranteed by design, not subject to production test.

Specifications subject to change without notice.

ADG728/ADG729

TIMING CHARACTERISTICS¹ ($V_{DD} = 2.7\text{ V to }5.5\text{ V}$. All specifications $-40^{\circ}\text{C to }+85^{\circ}\text{C}$, unless otherwise noted.)

Parameter	Limit at T_{MIN} , T_{MAX}	Unit	Conditions/Comments
f_{SCL}	400	kHz max	SCL Clock Frequency
t_1	2.5	ms min	SCL Cycle Time
t_2	0.6	ms min	t_{HIGH} , SCL High Time
t_3	1.3	ms min	t_{LOW} , SCL Low Time
t_4	0.6	ms min	$t_{HD, STA}$, Start/Repeated Start Condition Hold Time
t_5	100	ns min	$t_{SU, DAT}$, Data Setup Time
t_6^2	0.9	ms max	$t_{HD, DAT}$, Data Hold Time
	0	ms min	
t_7	0.6	ms min	$t_{SU, STA}$, Setup Time for Repeated Start
t_8	0.6	ms min	$t_{SU, STO}$, Stop Condition Setup Time
t_9	1.3	ms min	t_{BUF} , Bus Free Time Between a STOP Condition and a Start Condition
t_{10}	300	ns max	t_R , Rise Time of Both SCL and SDA when Receiving
	$20 + 0.1C_b^3$	ns min	
t_{11}	250	ns max	
	300	ns max	t_F , Fall Time of SDA when Receiving
	$0.1C_b^3$	ns min	
C_b	400	pF max	Capacitive Load for Each Bus Line
t_{SP}^4	50	ns max	Pulsewidth of Spike Suppressed

NOTES

¹See Figure 1.

²A master device must provide a hold time of at least 300 ns for the SDA signal (referred to the V_{IH} min of the SCL signal) in order to bridge the undefined region of the falling edge of SCL.

³ C_b is the total capacitance of one bus line in pF. t_R and t_F measured between $0.3 V_{DD}$ and $0.7 V_{DD}$.

⁴Input filtering on both the SCL and SDA inputs suppress noise spikes which are less than 50 ns.

Specifications subject to change without notice.

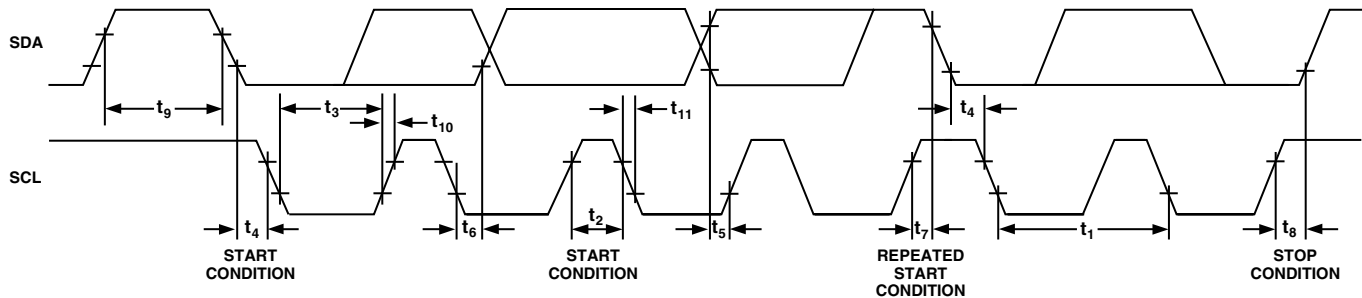
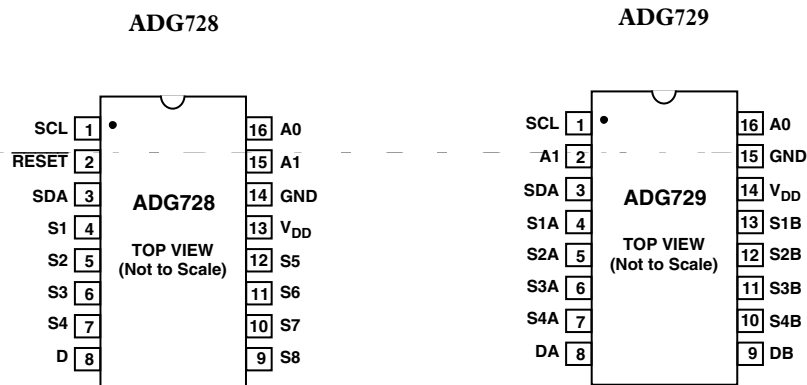

Figure 1. 2-Wire Serial Interface Timing Diagram

PIN FUNCTION DESCRIPTIONS

ADG728	ADG729	Mnemonic	Function
1	1	SCL	Serial Clock Line. This is used in conjunction with the SDA line to clock data into the 8-bit input shift register. Clock rates of up to 400 kbit/s can be accommodated with this 2-wire serial interface.
2		$\overline{\text{RESET}}$	Active low control input that clears the input register and turns all switches to the OFF condition.
3	3	SDA	Serial Data Line. This is used in conjunction with the SCL line to clock data into the 8-bit input shift register during the write cycle and used to read back 1 byte of data during the read cycle. It is a bidirectional open-drain data line which should be pulled to the supply with an external pull-up resistor.
4, 5, 6, 7	4, 5, 6, 7	Sxx	Source. May be an input or output.
8	8, 9	Dx	Drain. May be an input or output.
9, 10, 11, 12	10, 11, 12, 13	Sxx	Source. May be an input or output.
13	14	V _{DD}	Power Supply Input. These parts can be operated from a supply of 2.7 V to 5.5 V.
14	15	GND	Ground Reference.
15	2	A1	Address Input. Sets the second least significant bit of the 7-bit slave address.
16	16	A0	Address Input. Sets the least significant bit of the 7-bit slave address.

PIN CONFIGURATIONS



ORDERING GUIDE

Model	Temperature Range	Package Description	Package Option
ADG728BRU	-40°C to +85°C	Thin Shrink Small Outline Package (TSSOP)	RU-16
ADG729BRU	-40°C to +85°C	Thin Shrink Small Outline Package (TSSOP)	RU-16

ADG728/ADG729

ABSOLUTE MAXIMUM RATINGS¹

(T_A = 25°C unless otherwise noted.)

V _{DD} to GND	-0.3 V to +7 V
Analog, Digital Inputs ²	-0.3 V to V _{DD} + 0.3 V or 30 mA, Whichever Occurs First
Peak Current, S or D	100 mA (Pulsed at 1 ms, 10% Duty Cycle max)
Continuous Current, Each S	30 mA
Continuous Current D, ADG729	80 mA
Continuous Current D, ADG728	120 mA
Operating Temperature Range		
Industrial (B Version)	-40°C to +85°C
Storage Temperature Range	-65°C to +150°C
Junction Temperature	150°C

TSSOP Package

θ _{JA} Thermal Impedance	150.4°C/W
θ _{JC} Thermal Impedance	27.6°C/W
Lead Temperature, Soldering (10 seconds)	300°C
IR Reflow, Peak Temperature	220°C

NOTES

¹Stresses above those listed under Absolute Maximum Ratings may cause permanent damage to the device. This is a stress rating only; functional operation of the device at these or any other conditions above those listed in the operational sections of this specification is not implied. Exposure to absolute maximum rating conditions for extended periods may affect device reliability. Only one absolute maximum rating may be applied at any one time.

²Overvoltages at IN, S or D will be clamped by internal diodes. Current should be limited to the maximum ratings given.

CAUTION

ESD (electrostatic discharge) sensitive device. Electrostatic charges as high as 4000 V readily accumulate on the human body and test equipment and can discharge without detection. Although the ADG728/ADG729 features proprietary ESD protection circuitry, permanent damage may occur on devices subjected to high-energy electrostatic discharges. Therefore, proper ESD precautions are recommended to avoid performance degradation or loss of functionality.



TERMINOLOGY

V _{DD}	Most Positive Power Supply Potential.	C _D , C _S (ON)	“ON” Switch Capacitance. Measured with reference to ground.
I _{DD}	Positive Supply Current.	C _{IN}	Digital Input Capacitance.
GND	Ground (0 V) Reference.	t _{ON}	Delay time between the 50% and 90% points of the STOP condition and the switch “ON” condition.
S	Source Terminal. May be an input or output.	t _{OFF}	Delay time between the 50% and 90% points of the STOP condition and the switch “OFF” condition.
D	Drain Terminal. May be an input or output.	t _D	“OFF” time measured between the 80% points of both switches when switching from one switch to another.
V _D (V _S)	Analog Voltage on Terminals D, S.	Charge Injection	A measure of the glitch impulse transferred from the digital input to the analog output during switching.
R _{ON}	Ohmic Resistance between D and S.	Off Isolation	A measure of unwanted signal coupling through an “OFF” switch.
ΔR _{ON}	On Resistance Match Between any Two Channels, i.e., R _{ONmax} – R _{ONmin} .	Crosstalk	A measure of unwanted signal which is coupled through from one channel to another as a result of parasitic capacitance.
R _{FLAT(ON)}	Flatness is defined as the difference between the maximum and minimum value of on resistance as measured over the specified analog signal range.	Bandwidth	The frequency at which the output is attenuated by 3 dBs.
I _S (OFF)	Source Leakage Current with the Switch “OFF.”	On Response	The frequency response of the “ON” switch.
I _D (OFF)	Drain Leakage Current with the Switch “OFF.”	Insertion Loss	The loss due to the ON resistance of the switch.
I _D , I _S (ON)	Channel Leakage Current with the Switch “ON.”		
V _{INL}	Maximum Input Voltage for Logic “0.”		
V _{INH}	Minimum Input Voltage for Logic “1.”		
I _{INL} (I _{INH})	Input Current of the Digital Input.		
C _S (OFF)	“OFF” Switch Source Capacitance. Measured with reference to ground.		
C _D (OFF)	“OFF” Switch Drain Capacitance. Measured with reference to ground.		

Typical Performance Characteristics—ADG728/ADG729

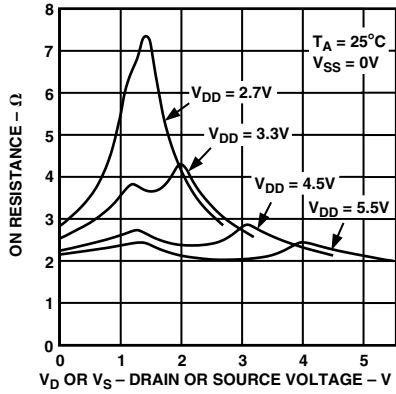

Figure 2. On Resistance as a Function of V_D (V_S) for Single Supply

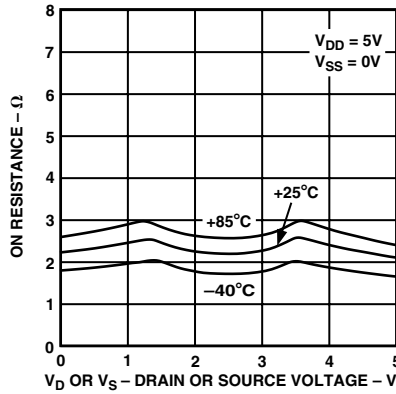

Figure 3. On Resistance as a Function of V_D (V_S) for Different Temperatures, Single Supply

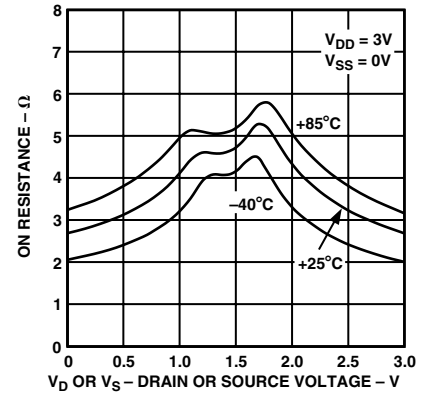

Figure 4. On Resistance as a Function of V_D (V_S) for Different Temperatures, Single Supply

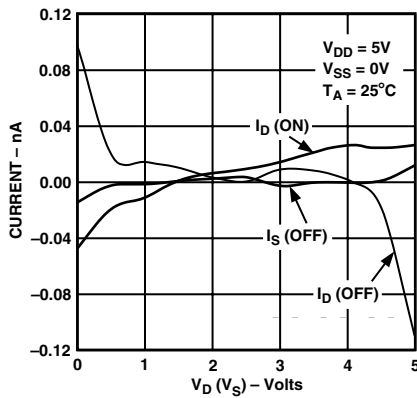

Figure 5. Leakage Currents as a Function of V_D (V_S)

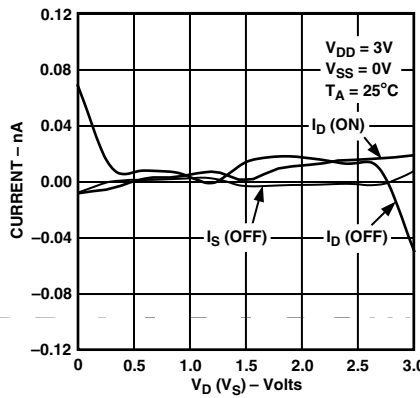

Figure 6. Leakage Currents as a Function of V_D (V_S)

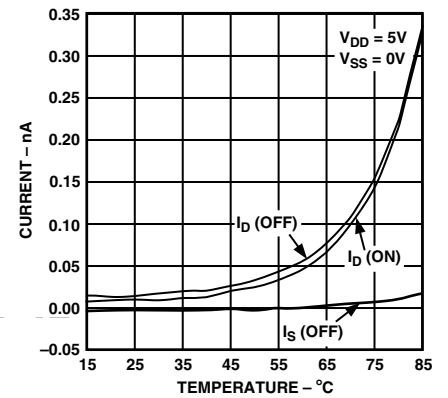

Figure 7. Leakage Currents as a Function of Temperature

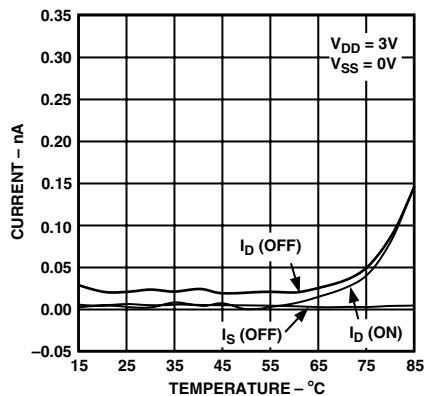

Figure 8. Leakage Currents as a Function of Temperature

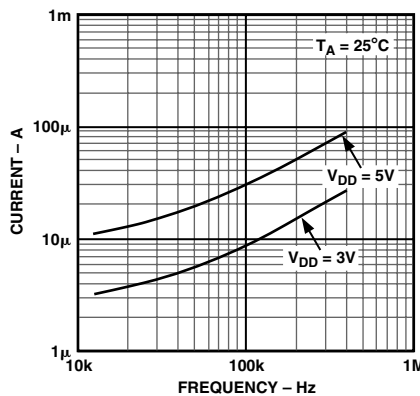

Figure 9. Input Current vs. Switching Frequency

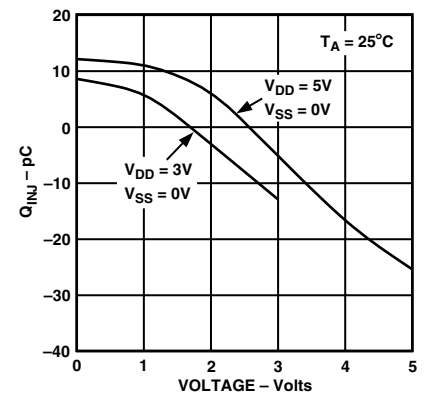

Figure 10. Charge Injection vs. Source Voltage

ADG728/ADG729

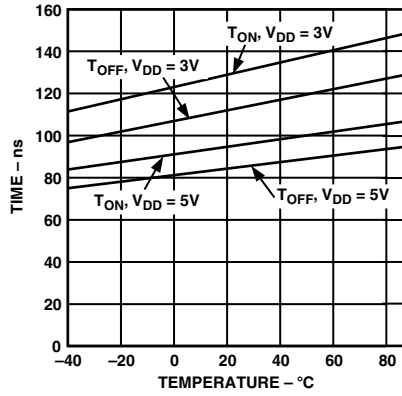

Figure 11. T_{ON}/T_{OFF} Times vs. Temperature

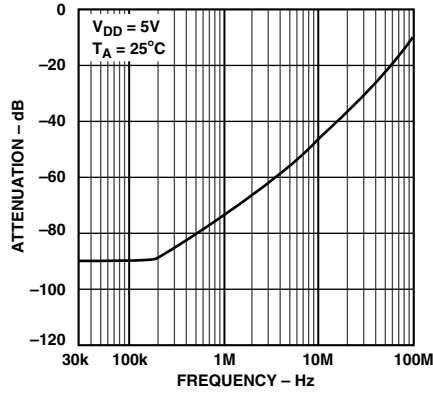

Figure 12. Off Isolation vs. Frequency

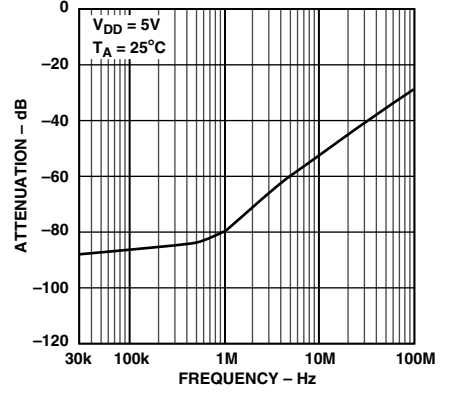

Figure 13. Crosstalk vs. Frequency

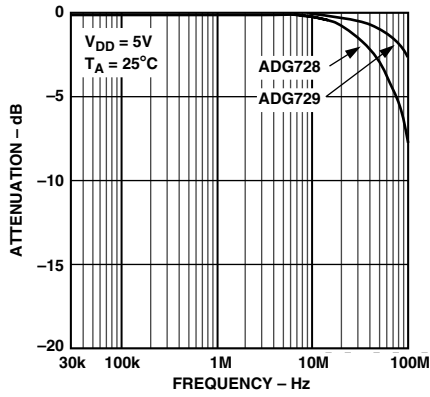

Figure 14. On Response vs. Frequency

GENERAL DESCRIPTION

The ADG728 and ADG729 are serially controlled, 8-channel and dual 4-channel matrix switches respectively. While providing the normal multiplexing and demultiplexing functions, these devices also provide the user with more flexibility as to where their signal may be routed. Each bit of the serial word corresponds to one switch of the device. A Logic 1 in the particular bit position turns on the switch, while a Logic 0 turns the switch off. Because each switch is independently controlled by an individual bit, this provides the option of having any, all, or none of the switches ON. This feature may be particularly useful in the demultiplexing application where the user may wish to direct one signal from the drain to a number of outputs (sources). Care must be taken, however, in the multiplexing situation where a number of inputs may be shorted together (separated only by the small on resistance of the switch).

When changing the switch conditions, a new 8-bit word is written to the input shift register. Some of the bits may be the same as the previous write cycle, as the user may not wish to change the state of some switches. In order to minimize glitches on the output of these switches, the part cleverly compares the state of switches from the previous write cycle. If the switch is already in the ON condition, and is required to stay ON, there will be minimal glitches on the output of the switch.

POWER-ON RESET

On power-up of the device, all switches will be in the OFF condition and the internal shift register is filled with zeros and will remain so until a valid write takes place.

SERIAL INTERFACE

2-Wire Serial Bus

The ADG728/ADG729 are controlled via an I²C compatible serial bus. These parts are connected to this bus as a slave device (no clock is generated by the multiplexer).

The ADG728/ADG729 have different 7-bit slave addresses. The five MSBs of the ADG728 are 10011, while the MSBs of the ADG729 are 10001 and the two LSBs are determined by the state of the A0 and A1 pins.

The 2-wire serial bus protocol operates as follows:

1. The master initiates data transfer by establishing a START condition which is when a high-to-low transition on the SDA line occurs while SCL is high. The following byte is the address byte, which consists of the 7-bit slave address followed by a R/W bit (this bit determines whether data will be read from or written to the slave device).

The slave whose address corresponds to the transmitted address responds by pulling the SDA line low during the ninth clock pulse (this is termed the Acknowledge bit). At this stage, all other devices on the bus remain idle while the selected device waits for data to be written to or read from its serial register. If the R/W bit is high, the master will read from the slave device. However, if the R/W bit is low, the master will write to the slave device.

2. Data is transmitted over the serial bus in sequences of nine clock pulses (eight data bits followed by an acknowledge bit). The transitions on the SDA line must occur during the low period of SCL and remain stable during the high period of SCL.
3. When all data bits have been read or written, a STOP condition is established by the master. A STOP condition is defined as a low-to-high transition on the SDA line while SCL is high. In Write mode, the master will pull the SDA line high during the 10th clock pulse to establish a STOP condition. In Read mode, the master will issue a No Acknowledge for the ninth clock pulse (i.e., the SDA line remains high). The master will then bring the SDA line low before the tenth clock pulse and then high during the tenth clock pulse to establish a STOP condition.

See Figures 18 to 21 below for a graphical explanation of the serial interface.

A repeated write function gives the user flexibility to update the matrix switch a number of times after addressing the part only once. During the write cycle, each data byte will update the configuration of the switches. For example, after the matrix switch has acknowledged its address byte, and receives one data byte, the switches will update after the data byte, if another data byte is written to the matrix switch while it is still the addressed slave device, this data byte will also cause a switch configuration update. Repeat read of the matrix switch is also allowed.

INPUT SHIFT REGISTER

The input shift register is eight bits wide. Figure 15 illustrates the contents of the input shift register. Data is loaded into the device as an 8-bit word under the control of a serial clock input, SCL. The timing diagram for this operation is shown in Figure 1. The 8-bit word consists of eight data bits each controlling one switch. MSB (Bit 7) is loaded first.

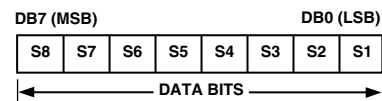

Figure 15. ADG728/ADG729 Input Shift Register Contents

ADG728/ADG729

WRITE OPERATION

When writing to the ADG728/ADG729, the user must begin with an address byte and R/\bar{W} bit, after which the switch will acknowledge that it is prepared to receive data by pulling SDA low. This address byte is followed by the 8-bit word. The write operations for each matrix switch are shown in the figures below.

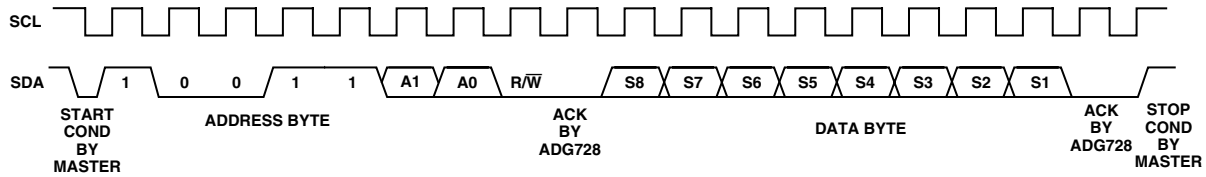

Figure 16. ADG728 Write Sequence

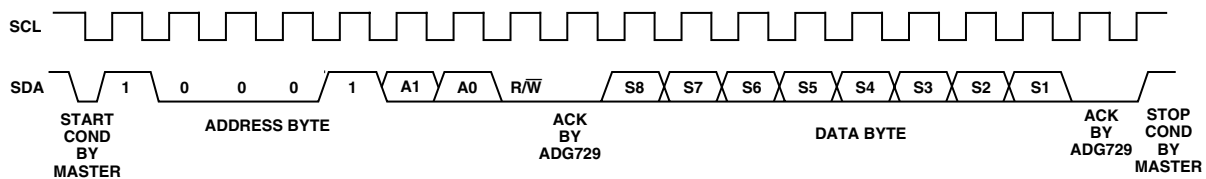

Figure 17. ADG729 Write Sequence

READ OPERATION

When reading data back from the ADG728/ADG729, the user must begin with an address byte and R/\bar{W} bit, after which the matrix switch will acknowledge that it is prepared to transmit data by pulling SDA low. The readback operation is a single byte that consists of the eight data bits in the input register. The read operations for each part are shown in Figures 18 and 19.

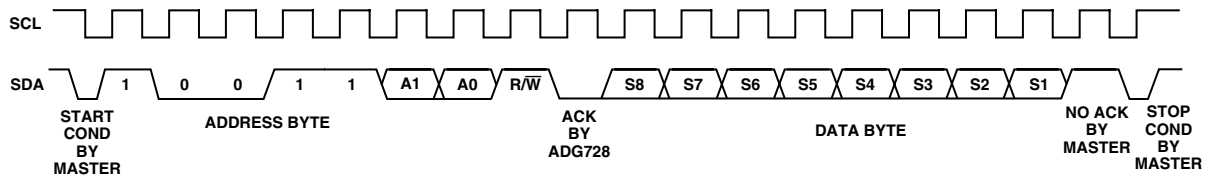

Figure 18. ADG728 Readback Sequence

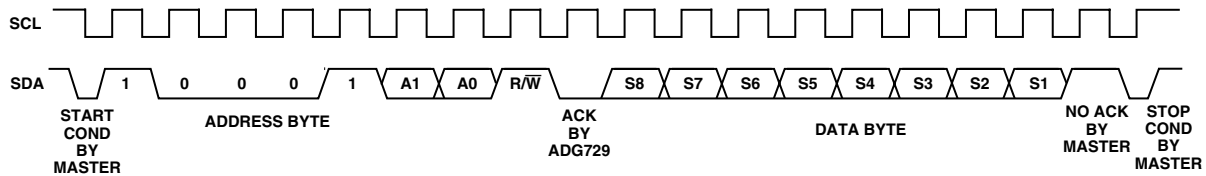

Figure 19. ADG729 Readback Sequence

MULTIPLE DEVICES ON ONE BUS

Figure 20 shows four ADG728s devices on the same serial bus. Each has a different slave address since the state of their A0 and A1 pins is different. This allows each Matrix Switch to be written to or read from independently. Because the ADG729 has a different address to the ADG728, it would be possible for four of each of these devices to be connected to the same bus.

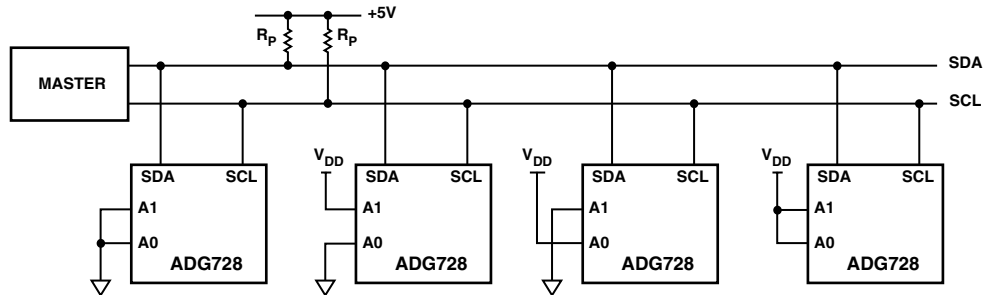
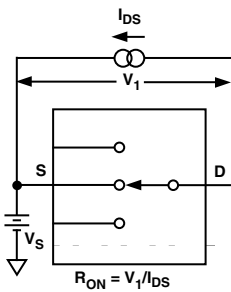
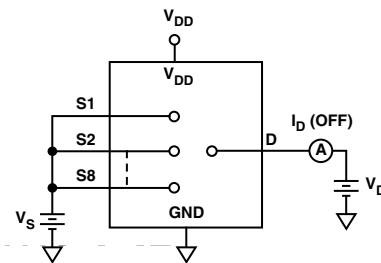

Figure 20. Multiple ADG728s on the Same Bus

TEST CIRCUITS



Test Circuit 1. On Resistance



Test Circuit 3. I_S (OFF)

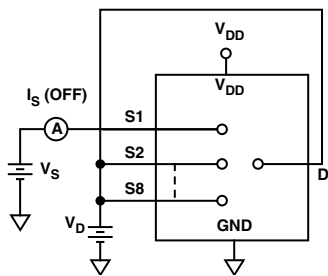

Test Circuit 2. I_D (OFF)

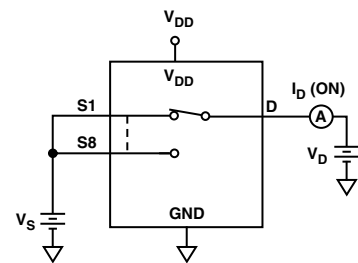

Test Circuit 4. I_D (ON)

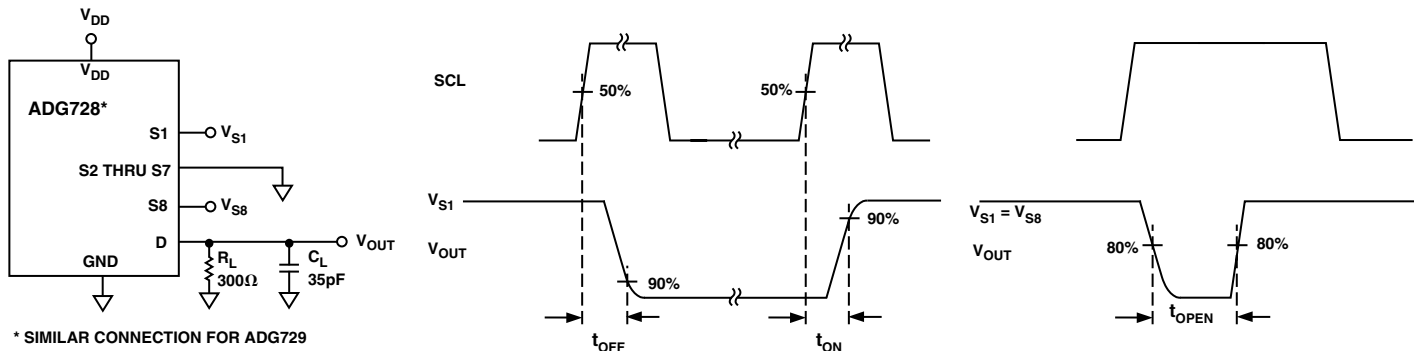

* SIMILAR CONNECTION FOR ADG729

Test Circuit 5. Switching Times and Break-Before-Make Times

ADG728/ADG729

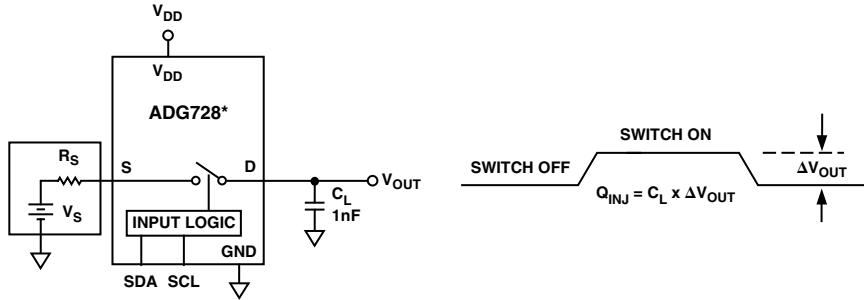

* SIMILAR CONNECTION FOR ADG729

Test Circuit 6. Charge Injection

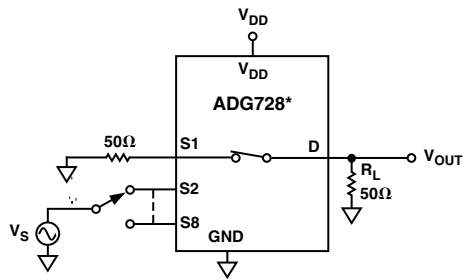

* SIMILAR CONNECTION FOR ADG729

CHANNEL-TO-CHANNEL CROSSTALK = $20\text{LOG}_{10}(V_{\text{OUT}}/V_S)$

Test Circuit 7. Channel-to-Channel Crosstalk

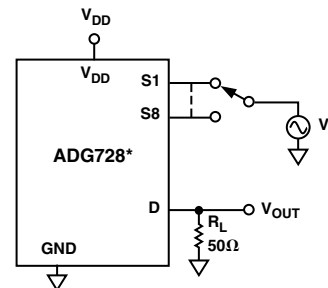

*SIMILAR CONNECTION FOR ADG729

S1 IS SWITCHED OFF FOR OFF ISOLATION MEASUREMENTS AND ON FOR BANDWIDTH MEASUREMENTS

OFF ISOLATION = $20\text{LOG}_{10}(V_{\text{OUT}}/V_S)$

INSERTION LOSS = $20\text{LOG}_{10}\left(\frac{V_{\text{OUT WITH SWITCH}}}{V_{\text{OUT WITHOUT SWITCH}}}\right)$

Test Circuit 8. Off Isolation and Bandwidth

OUTLINE DIMENSIONS

Dimensions shown in inches and (mm).

16-Lead TSSOP (RU-16)

