

## ADuM3470/ADuM3471/ADuM3472/ADuM3473/ADuM3474

### FEATURES

- Isolated PWM controller
- Integrated transformer driver
- Regulated adjustable output: 3.3 V to 24 V
- 2 W output power
- 70% efficiency at guaranteed load of 400 mA at 5.0 V output
- Quad dc-to-25 Mbps (NRZ) signal isolation channels
- 20-lead SSOP package
- High temperature operation: 105°C
- High common-mode transient immunity: >25 kV/ $\mu$ s
- 200 kHz to 1 MHz adjustable oscillator frequency
- Soft start function at power-up
- Pulse-by-pulse overcurrent protection
- Thermal shutdown
- 2500 V rms isolation

### APPLICATIONS

- RS-232/RS-422/RS-485 transceivers
- Industrial field bus isolation
- Power supply startup bias and gate drives
- Isolated sensor interfaces
- Process controls

### GENERAL DESCRIPTION

The ADuM3470/ADuM3471/ADuM3472/ADuM3473/ADuM3474 devices<sup>1</sup> are quad-channel, digital isolators with an integrated PWM controller and transformer driver for an isolated dc-to-dc converter. Based on the Analog Devices, Inc., *iCoupler*<sup>®</sup> technology, the dc-to-dc converter provides up to 2 W of regulated, isolated power at 3.3 V to 24 V from a 5.0 V input supply or from a 3.3 V supply. This eliminates the need for a separate, isolated dc-to-dc converter in 2 W isolated designs. The *iCoupler* chip-scale transformer technology is used to isolate the logic signals, and the integrated transformer driver with isolated secondary side control provides higher efficiency for the isolated dc-to-dc converter. The result is a small form factor, total isolation solution.

The ADuM347x isolators provide four independent isolation channels in a variety of channel configurations and data rates. (The x in ADuM347x throughout this data sheet stands for the ADuM3470/ADuM3471/ADuM3472/ADuM3473/ADuM3474.)

### FUNCTIONAL BLOCK DIAGRAMS

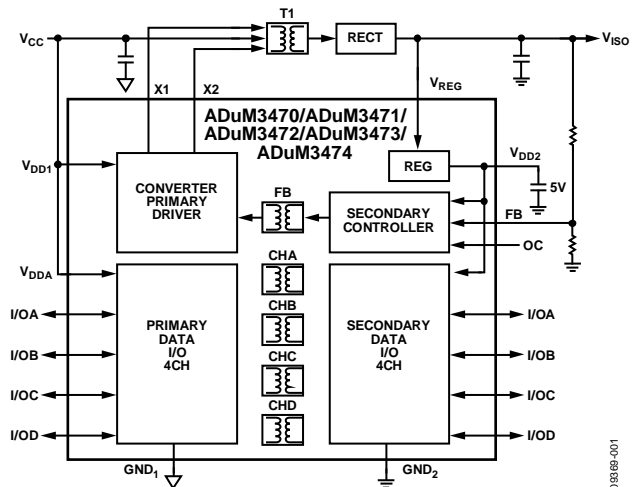

Figure 1. Functional Block Diagram

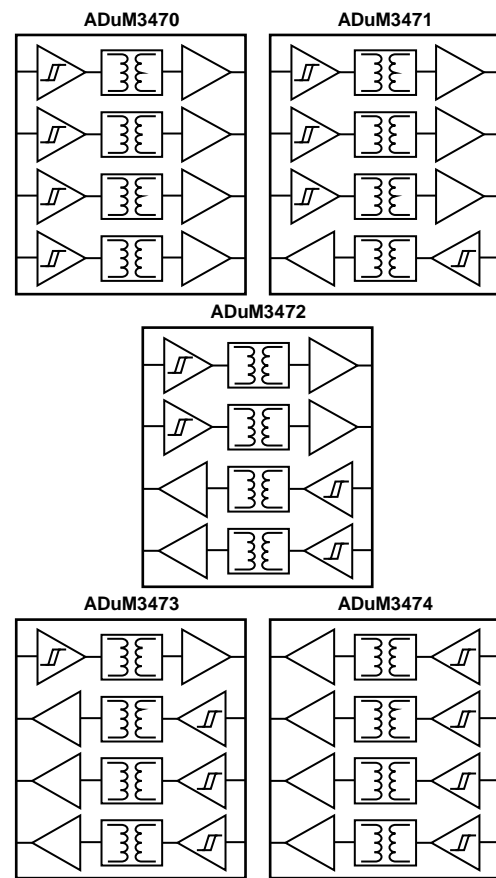

Figure 2. Block Diagrams of I/O Channels

<sup>1</sup> Protected by U.S. Patents 5,952,849; 6,873,065; and 7075 329 B2. Other patents pending.

#### Rev. 0

Information furnished by Analog Devices is believed to be accurate and reliable. However, no responsibility is assumed by Analog Devices for its use, nor for any infringements of patents or other rights of third parties that may result from its use. Specifications subject to change without notice. No license is granted by implication or otherwise under any patent or patent rights of Analog Devices. Trademarks and registered trademarks are the property of their respective owners.

**TABLE OF CONTENTS**

Features .....	1	Terminology .....	24
Applications.....	1	Applications Information .....	25
General Description .....	1	Theory of Operation .....	25
Functional Block Diagrams.....	1	Application Schematics .....	25
Revision History .....	2	Transformer Design .....	26
Specifications.....	3	Transformer Turns Ratio.....	26
Electrical Characteristics—5 V Primary Input Supply/5 V		Transformer ET Constant .....	26
Secondary Isolated Supply .....	3	Transformer Primary Inductance and Resistance .....	26
Electrical Characteristics—3.3 V Primary Input Supply/3.3 V		Transformer Isolation Voltage .....	27
Secondary Isolated Supply .....	5	Switching Frequency.....	27
Electrical Characteristics—5 V Primary Input Supply/3.3 V		Transient Response .....	27
Secondary Isolated Supply .....	7	Component Selection .....	27
Electrical Characteristics—5 V Primary Input Supply/15 V		Printed Circuit Board (PCB) Layout .....	28
Secondary Isolated Supply .....	9	Thermal Analysis .....	28
Package Characteristics .....	11	Propagation Delay-Related Parameters.....	28
Regulatory Approvals.....	11	DC Correctness and Magnetic Field Immunity.....	29
Insulation and Safety-Related Specifications.....	11	Power Consumption .....	30
DIN V VDE V 0884-10 (VDE V 0884-10) Insulation		Power Considerations.....	30
Characteristics .....	12	Insulation Lifetime .....	31
Recommended Operating Conditions .....	12	Outline Dimensions .....	32
Absolute Maximum Ratings.....	13	Ordering Guide .....	32
ESD Caution.....	13		
Pin Configurations and Function Descriptions .....	14		
Typical Performance Characteristics .....	19		

**REVISION HISTORY**

**10/10—Revision 0: Initial Version**

## SPECIFICATIONS

### ELECTRICAL CHARACTERISTICS—5 V PRIMARY INPUT SUPPLY/5 V SECONDARY ISOLATED SUPPLY

4.5 V ≤ (V<sub>DD1</sub> = V<sub>DDA</sub>) ≤ 5.5 V; V<sub>DD2</sub> = V<sub>REG</sub> = V<sub>ISO</sub> = 5.0 V; f<sub>SW</sub> = 500 kHz; all voltages are relative to their respective grounds; see the application schematic in Figure 38. All minimum/maximum specifications apply over the entire recommended operating range, unless otherwise noted. All typical specifications are at T<sub>A</sub> = 25°C, V<sub>DD1</sub> = V<sub>DDA</sub> = 5.0 V, V<sub>DD2</sub> = V<sub>REG</sub> = V<sub>ISO</sub> = 5.0 V.

**Table 1.**

Parameter	Symbol	Min	Typ	Max	Unit	Test Conditions/Comments
<b>DC-TO-DC CONVERTER POWER SUPPLY</b>						
Isolated Output Voltage	V <sub>ISO</sub>	4.5	5.0	5.5	V	I <sub>ISO</sub> = 0 mA, V <sub>ISO</sub> = V <sub>FB</sub> × (R1 + R2)/R2
Feedback Voltage Setpoint	V <sub>FB</sub>	1.15	1.25	1.35	V	I <sub>ISO</sub> = 0 mA
Line Regulation	V <sub>ISO (LINE)</sub>		1	10	mV/V	I <sub>ISO</sub> = 50 mA, V <sub>CC</sub> = 4.5 V to 5.5 V
Load Regulation	V <sub>ISO (LOAD)</sub>		1	2	%	I <sub>ISO</sub> = 50 mA to 200 mA
Output Ripple	V <sub>ISO (RIP)</sub>		50		mV p-p	20 MHz bandwidth, C <sub>OUT</sub> = 0.1 μF  47 μF, I <sub>ISO</sub> = 100 mA
Output Noise	V <sub>ISO (N)</sub>		100		mV p-p	20 MHz bandwidth, C <sub>OUT</sub> = 0.1 μF  47 μF, I <sub>ISO</sub> = 100 mA
Switching Frequency	f <sub>SW</sub>		1000		kHz	R <sub>OC</sub> = 50 kΩ
			200		kHz	R <sub>OC</sub> = 270 kΩ
		192	318	515	kHz	V <sub>OC</sub> = V <sub>DD2</sub> (open loop)
Switch On-Resistance	R <sub>ON</sub>		0.5		Ω	
<b>Undervoltage Lockout, V<sub>CC</sub>, V<sub>DD2</sub> Supplies</b>						
Positive Going Threshold	V <sub>UV+</sub>		2.8		V	
Negative Going Threshold	V <sub>UV-</sub>		2.6		V	
Hysteresis	V <sub>UVH</sub>		0.2		V	
<b>iCoupler DATA CHANNELS</b>						
<b>DC to 2 Mbps Data Rate<sup>1</sup></b>						
Maximum Output Supply Current <sup>2</sup>	I <sub>ISO (MAX)</sub>	400			mA	f ≤ 1 MHz, V <sub>ISO</sub> = 5.0 V
Efficiency at Maximum Output Supply Current <sup>3</sup>			70		%	I <sub>ISO</sub> = I <sub>ISO (MAX)</sub> , f ≤ 1 MHz
I <sub>CC</sub> Supply Current, No V <sub>ISO</sub> Load	I <sub>CC (Q)</sub>					I <sub>ISO</sub> = 0 mA, f ≤ 1 MHz
ADuM3470			14	30	mA	
ADuM3471			15	30	mA	
ADuM3472			16	30	mA	
ADuM3473			17	30	mA	
ADuM3474			18	30	mA	
<b>25 Mbps Data Rate (CRWZ Grade Only)</b>						
I <sub>CC</sub> Supply Current, No V <sub>ISO</sub> Load	I <sub>CC (D)</sub>					
ADuM3470			44		mA	I <sub>ISO</sub> = 0 mA, C <sub>L</sub> = 15 pF, f = 12.5 MHz
ADuM3471			46		mA	I <sub>ISO</sub> = 0 mA, C <sub>L</sub> = 15 pF, f = 12.5 MHz
ADuM3472			48		mA	I <sub>ISO</sub> = 0 mA, C <sub>L</sub> = 15 pF, f = 12.5 MHz
ADuM3473			50		mA	I <sub>ISO</sub> = 0 mA, C <sub>L</sub> = 15 pF, f = 12.5 MHz
ADuM3474			52		mA	I <sub>ISO</sub> = 0 mA, C <sub>L</sub> = 15 pF, f = 12.5 MHz
Available V <sub>ISO</sub> Supply Current <sup>4</sup>	I <sub>ISO (LOAD)</sub>					f <sub>SW</sub> = 500 kHz
ADuM3470			390		mA	C <sub>L</sub> = 15 pF, f = 12.5 MHz
ADuM3471			388		mA	C <sub>L</sub> = 15 pF, f = 12.5 MHz
ADuM3472			386		mA	C <sub>L</sub> = 15 pF, f = 12.5 MHz
ADuM3473			384		mA	C <sub>L</sub> = 15 pF, f = 12.5 MHz
ADuM3474			382		mA	C <sub>L</sub> = 15 pF, f = 12.5 MHz
I <sub>CC</sub> Supply Current, Full V <sub>ISO</sub> Load	I <sub>CC (MAX)</sub>		550		mA	C <sub>L</sub> = 0 pF, f = 0 MHz, V <sub>DD</sub> = 5 V, I <sub>ISO</sub> = 400 mA
I/O Input Currents	I <sub>IA</sub> , I <sub>IB</sub> , I <sub>IC</sub> , I <sub>ID</sub>	-20	+0.01	+20	μA	
Logic High Input Threshold	V <sub>IH</sub>	2.0			V	
Logic Low Input Threshold	V <sub>IL</sub>			0.8	V	

# ADuM3470/ADuM3471/ADuM3472/ADuM3473/ADuM3474

Parameter	Symbol	Min	Typ	Max	Unit	Test Conditions/Comments
Logic High Output Voltages	$V_{OAH}, V_{OBH}, V_{OCH}, V_{ODH}$	$V_{CC} - 0.3, V_{ISO} - 0.3$	5.0		V	$I_{Ox} = -20 \mu A, V_{Ix} = V_{IxH}$
Logic Low Output Voltages	$V_{OAL}, V_{OBL}, V_{OCL}, V_{ODL}$	$V_{CC} - 0.5, V_{ISO} - 0.3$	4.8		V	$I_{Ox} = -4 \text{ mA}, V_{Ix} = V_{IxH}$
			0.0	0.1	V	$I_{Ox} = 20 \mu A, V_{Ix} = V_{IxL}$
			0.0	0.4	V	$I_{Ox} = 4 \text{ mA}, V_{Ix} = V_{IxL}$
<b>AC SPECIFICATIONS</b>						
<b>ADuM347xARWZ</b>						
Minimum Pulse Width	PW			1000	ns	$C_L = 15 \text{ pF}$ , CMOS signal levels
Maximum Data Rate		1			Mbps	$C_L = 15 \text{ pF}$ , CMOS signal levels
Propagation Delay	$t_{PHL}, t_{PLH}$		55	100	ns	$C_L = 15 \text{ pF}$ , CMOS signal levels
Pulse Width Distortion, $ t_{PLH} - t_{PHL} $	PWD			40	ns	$C_L = 15 \text{ pF}$ , CMOS signal levels
Propagation Delay Skew	$t_{PSK}$			50	ns	$C_L = 15 \text{ pF}$ , CMOS signal levels
Channel-to-Channel Matching	$t_{PSKCD}/t_{PSKOD}$			50	ns	$C_L = 15 \text{ pF}$ , CMOS signal levels
<b>ADuM347xCRWZ</b>						
Minimum Pulse Width	PW			40	ns	$C_L = 15 \text{ pF}$ , CMOS signal levels
Maximum Data Rate		25			Mbps	$C_L = 15 \text{ pF}$ , CMOS signal levels
Propagation Delay	$t_{PHL}, t_{PLH}$	30	45	60	ns	$C_L = 15 \text{ pF}$ , CMOS signal levels
Pulse Width Distortion, $ t_{PLH} - t_{PHL} $	PWD			6	ns	$C_L = 15 \text{ pF}$ , CMOS signal levels
Change vs. Temperature			5		ps/ $^{\circ}\text{C}$	$C_L = 15 \text{ pF}$ , CMOS signal levels
Propagation Delay Skew	$t_{PSK}$			15	ns	$C_L = 15 \text{ pF}$ , CMOS signal levels
Channel-to-Channel Matching, Codirectional Channels	$t_{PSKCD}$			6	ns	$C_L = 15 \text{ pF}$ , CMOS signal levels
Channel-to-Channel Matching, Opposing Directional Channels	$t_{PSKOD}$			15	ns	$C_L = 15 \text{ pF}$ , CMOS signal levels
Output Rise/Fall Time (10% to 90%)	$t_R/t_F$		2.5		ns	$C_L = 15 \text{ pF}$ , CMOS signal levels
Common-Mode Transient Immunity at Logic High Output	$ CM_H $	25	35		kV/ $\mu\text{s}$	$V_{Ix} = V_{DD}$ or $V_{ISO}$ , $V_{CM} = 1000 \text{ V}$ , transient magnitude = 800 V
Common-Mode Transient Immunity at Logic Low Output	$ CM_L $	25	35		kV/ $\mu\text{s}$	$V_{Ix} = 0 \text{ V}$ , $V = 1000 \text{ V}$ , transient magnitude = 800 V
Refresh Rate	$f_r$		1.0		Mbps	

<sup>1</sup> The contributions of supply current values for all four channels are combined at identical data rates.

<sup>2</sup> The  $V_{ISO}$  supply current is available for external use when all data rates are below 2 Mbps. At data rates above 2 Mbps, the data I/O channels draw additional current proportional to the data rate. Additional supply current associated with an individual channel operating at a given data rate can be calculated as described in the Power Consumption section. The dynamic I/O channel load must be treated as an external load and included in the  $V_{ISO}$  power budget.

<sup>3</sup> The power demands of the quiescent operation of the data channels was not separated from the power supply section. Efficiency includes the quiescent power consumed by the I/O channels as part of the internal power consumption.

<sup>4</sup> This current is available for driving external loads at the  $V_{ISO}$  output. All channels are simultaneously driven at a maximum data rate of 25 Mbps with full capacitive load representing the maximum dynamic load conditions. Refer to the Power Consumption section for calculation of available current at less than the maximum data rate.

# ADuM3470/ADuM3471/ADuM3472/ADuM3473/ADuM3474

## ELECTRICAL CHARACTERISTICS—3.3 V PRIMARY INPUT SUPPLY/3.3 V SECONDARY ISOLATED SUPPLY

3.0 V ≤ (V<sub>DD1</sub> = V<sub>DDA</sub>) ≤ 3.6 V; V<sub>DD2</sub> = V<sub>REG</sub> = V<sub>ISO</sub> = 3.3 V; f<sub>SW</sub> = 500 kHz; all voltages are relative to their respective grounds; see the application schematic in Figure 38. All minimum/maximum specifications apply over the entire recommended operating range, unless otherwise noted. All typical specifications are at T<sub>A</sub> = 25°C, V<sub>DD1</sub> = V<sub>DDA</sub> = 3.3 V, V<sub>DD2</sub> = V<sub>REG</sub> = V<sub>ISO</sub> = 3.3 V.

**Table 2.**

Parameter	Symbol	Min	Typ	Max	Unit	Test Conditions/Comments
<b>DC-TO-DC CONVERTER POWER SUPPLY</b>						
Isolated Output Voltage	V <sub>ISO</sub>	3.0	3.3	3.6	V	I <sub>ISO</sub> = 0 mA, V <sub>ISO</sub> = V <sub>FB</sub> × (R1 + R2)/R2
Feedback Voltage Setpoint	V <sub>FB</sub>	1.15	1.25	1.35	V	I <sub>ISO</sub> = 0 mA
Line Regulation	V <sub>ISO (LINE)</sub>		1	10	mV/V	I <sub>ISO</sub> = 50 mA, V <sub>CC</sub> = 3.0 V to 3.6 V
Load Regulation	V <sub>ISO (LOAD)</sub>		1	2	%	I <sub>ISO</sub> = 20 mA to 100 mA
Output Ripple	V <sub>ISO (RIP)</sub>		50		mV p-p	20 MHz bandwidth, C <sub>OUT</sub> = 0.1 μF  47 μF, I <sub>ISO</sub> = 100 mA
Output Noise	V <sub>ISO (N)</sub>		100		mV p-p	20 MHz bandwidth, C <sub>OUT</sub> = 0.1 μF  47 μF, I <sub>ISO</sub> = 100 mA
Switching Frequency	f <sub>SW</sub>		1000		kHz	R <sub>OC</sub> = 50 kΩ
			200		kHz	R <sub>OC</sub> = 270 kΩ
		192	318	515	kHz	V <sub>OC</sub> = V <sub>DD2</sub> (open loop)
Switch On-Resistance	R <sub>ON</sub>		0.6		Ω	
Undervoltage Lockout, V <sub>CC</sub> , V <sub>DD2</sub> Supplies						
Positive Going Threshold	V <sub>UV+</sub>		2.8		V	
Negative Going Threshold	V <sub>UV-</sub>		2.6		V	
Hysteresis	V <sub>UVH</sub>		0.2		V	
<b>iCoupler DATA CHANNELS</b>						
<b>DC to 2 Mbps Data Rate<sup>1</sup></b>						
Maximum Output Supply Current <sup>2</sup>	I <sub>ISO (MAX)</sub>	250			mA	f ≤ 1 MHz, V <sub>ISO</sub> = 3.3 V
Efficiency at Maximum Output Supply Current <sup>3</sup>			70		%	I <sub>ISO</sub> = I <sub>ISO (MAX)</sub> , f ≤ 1 MHz
I <sub>CC</sub> Supply Current, No V <sub>ISO</sub> Load	I <sub>CC (Q)</sub>					I <sub>ISO</sub> = 0 mA, f ≤ 1 MHz
ADuM3470			9	20	mA	
ADuM3471			10	20	mA	
ADuM3472			11	20	mA	
ADuM3473			11	20	mA	
ADuM3474			12	20	mA	
<b>25 Mbps Data Rate (CRWZ Grade Only)</b>						
I <sub>CC</sub> Supply Current, No V <sub>ISO</sub> Load	I <sub>CC (D)</sub>					
ADuM3470			28		mA	I <sub>ISO</sub> = 0 mA, C <sub>L</sub> = 15 pF, f = 12.5 MHz
ADuM3471			29		mA	I <sub>ISO</sub> = 0 mA, C <sub>L</sub> = 15 pF, f = 12.5 MHz
ADuM3472			31		mA	I <sub>ISO</sub> = 0 mA, C <sub>L</sub> = 15 pF, f = 12.5 MHz
ADuM3473			32		mA	I <sub>ISO</sub> = 0 mA, C <sub>L</sub> = 15 pF, f = 12.5 MHz
ADuM3474			34		mA	I <sub>ISO</sub> = 0 mA, C <sub>L</sub> = 15 pF, f = 12.5 MHz
Available V <sub>ISO</sub> Supply Current <sup>4</sup>	I <sub>ISO (LOAD)</sub>					
ADuM3470			244		mA	C <sub>L</sub> = 15 pF, f = 12.5 MHz
ADuM3471			243		mA	C <sub>L</sub> = 15 pF, f = 12.5 MHz
ADuM3472			241		mA	C <sub>L</sub> = 15 pF, f = 12.5 MHz
ADuM3473			240		mA	C <sub>L</sub> = 15 pF, f = 12.5 MHz
ADuM3474			238		mA	C <sub>L</sub> = 15 pF, f = 12.5 MHz
I <sub>CC</sub> Supply Current, Full V <sub>ISO</sub> Load	I <sub>CC (MAX)</sub>		350		mA	C <sub>L</sub> = 0 pF, f = 0 MHz, V <sub>DD</sub> = 3.3 V, I <sub>ISO</sub> = 250 mA
I/O Input Currents	I <sub>IA</sub> , I <sub>IB</sub> , I <sub>IC</sub> , I <sub>ID</sub>	-10	+0.01	+10	μA	
Logic High Input Threshold	V <sub>IH</sub>	1.6			V	
Logic Low Input Threshold	V <sub>IL</sub>			0.4	V	

# ADuM3470/ADuM3471/ADuM3472/ADuM3473/ADuM3474

Parameter	Symbol	Min	Typ	Max	Unit	Test Conditions/Comments
Logic High Output Voltages	$V_{OAH}, V_{OBH}, V_{OCH}, V_{ODH}$	$V_{CC} - 0.2, V_{ISO} - 0.2$	5.0		V	$I_{ox} = -20 \mu A, V_{ix} = V_{ixH}$
Logic Low Output Voltages	$V_{OAL}, V_{OBL}, V_{OCL}, V_{ODL}$	$V_{CC} - 0.5, V_{ISO} - 0.5$	4.8		V	$I_{ox} = -4 \text{ mA}, V_{ix} = V_{ixH}$
			0.0	0.1	V	$I_{ox} = 20 \mu A, V_{ix} = V_{ixL}$
			0.0	0.4	V	$I_{ox} = 4 \text{ mA}, V_{ix} = V_{ixL}$
<b>AC SPECIFICATIONS</b>						
<b>ADuM347xARWZ</b>						
Minimum Pulse Width	PW			1000	ns	$C_L = 15 \text{ pF}$ , CMOS signal levels
Maximum Data Rate		1			Mbps	$C_L = 15 \text{ pF}$ , CMOS signal levels
Propagation Delay	$t_{PHL}, t_{PLH}$		60	100	ns	$C_L = 15 \text{ pF}$ , CMOS signal levels
Pulse Width Distortion, $ t_{PLH} - t_{PHL} $	PWD			40	ns	$C_L = 15 \text{ pF}$ , CMOS signal levels
Propagation Delay Skew	$t_{PSK}$			50	ns	$C_L = 15 \text{ pF}$ , CMOS signal levels
Channel-to-Channel Matching	$t_{PSKCD}/t_{PSKOD}$			50	ns	$C_L = 15 \text{ pF}$ , CMOS signal levels
<b>ADuM347xCRWZ</b>						
Minimum Pulse Width	PW			40	ns	$C_L = 15 \text{ pF}$ , CMOS signal levels
Maximum Data Rate		25			Mbps	$C_L = 15 \text{ pF}$ , CMOS signal levels
Propagation Delay	$t_{PHL}, t_{PLH}$	30	60	75	ns	$C_L = 15 \text{ pF}$ , CMOS signal levels
Pulse Width Distortion, $ t_{PLH} - t_{PHL} $	PWD			8	ns	$C_L = 15 \text{ pF}$ , CMOS signal levels
Change vs. Temperature			5		ps/°C	$C_L = 15 \text{ pF}$ , CMOS signal levels
Propagation Delay Skew	$t_{PSK}$			45	ns	$C_L = 15 \text{ pF}$ , CMOS signal levels
Channel-to-Channel Matching, Codirectional Channels	$t_{PSKCD}$			8	ns	$C_L = 15 \text{ pF}$ , CMOS signal levels
Channel-to-Channel Matching, Opposing Directional Channels	$t_{PSKOD}$			15	ns	$C_L = 15 \text{ pF}$ , CMOS signal levels
Output Rise/Fall Time (10% to 90%)	$t_R/t_F$		2.5		ns	$C_L = 15 \text{ pF}$ , CMOS signal levels
Common-Mode Transient Immunity at Logic High Output	$ CM_H $	25	35		kV/ $\mu$ s	$V_{ix} = V_{DD}$ or $V_{ISO}$ , $V_{CM} = 1000 \text{ V}$ , transient magnitude = 800 V
Common-Mode Transient Immunity at Logic Low Output	$ CM_L $	25	35		kV/ $\mu$ s	$V_{ix} = 0 \text{ V}$ , $V = 1000 \text{ V}$ , transient magnitude = 800 V
Refresh Rate	$f_r$		1.0		Mbps	

<sup>1</sup> The contributions of supply current values for all four channels are combined at identical data rates.

<sup>2</sup> The  $V_{ISO}$  supply current is available for external use when all data rates are below 2 Mbps. At data rates above 2 Mbps, the data I/O channels draw additional current proportional to the data rate. Additional supply current associated with an individual channel operating at a given data rate can be calculated as described in the Power Consumption section. The dynamic I/O channel load must be treated as an external load and included in the  $V_{ISO}$  power budget.

<sup>3</sup> The power demands of the quiescent operation of the data channels was not separated from the power supply section. Efficiency includes the quiescent power consumed by the I/O channels as part of the internal power consumption.

<sup>4</sup> This current is available for driving external loads at the  $V_{ISO}$  output. All channels are simultaneously driven at a maximum data rate of 25 Mbps with full capacitive load representing the maximum dynamic load conditions. Refer to the Power Consumption section for calculation of available current at less than the maximum data rate.

# ADuM3470/ADuM3471/ADuM3472/ADuM3473/ADuM3474

## ELECTRICAL CHARACTERISTICS—5 V PRIMARY INPUT SUPPLY/3.3 V SECONDARY ISOLATED SUPPLY

4.5 V ≤ (V<sub>DD1</sub> = V<sub>DDA</sub>) ≤ 5.5 V; V<sub>DD2</sub> = V<sub>REG</sub> = V<sub>ISO</sub> = 3.3 V; f<sub>SW</sub> = 500 kHz; all voltages are relative to their respective grounds; see the application schematic in Figure 38. All minimum/maximum specifications apply over the entire recommended operating range, unless otherwise noted. All typical specifications are at T<sub>A</sub> = 25°C, V<sub>DD1</sub> = V<sub>DDA</sub> = 5.0 V, V<sub>DD2</sub> = V<sub>REG</sub> = V<sub>ISO</sub> = 3.3 V.

**Table 3.**

Parameter	Symbol	Min	Typ	Max	Unit	Test Conditions/Comments	
<b>DC-TO-DC CONVERTER POWER SUPPLY</b>							
Isolated Output Voltage	V <sub>ISO</sub>	3.0	3.3	3.6	V	I <sub>ISO</sub> = 0 mA, V <sub>ISO</sub> = V <sub>FB</sub> × (R1 + R2)/R2	
Feedback Voltage Setpoint	V <sub>FB</sub>	1.15	1.25	1.35	V	I <sub>ISO</sub> = 0 mA	
Line Regulation	V <sub>ISO (LINE)</sub>		1	10	mV/V	I <sub>ISO</sub> = 50 mA, V <sub>CC</sub> = 4.5 V to 5.5 V	
Load Regulation	V <sub>ISO (LOAD)</sub>		1	2	%	I <sub>ISO</sub> = 50 mA to 200 mA	
Output Ripple	V <sub>ISO (RIP)</sub>		50		mV p-p	20 MHz bandwidth, C <sub>OUT</sub> = 0.1 μF  47 μF, I <sub>ISO</sub> = 100 mA	
Output Noise	V <sub>ISO (N)</sub>		100		mV p-p	20 MHz bandwidth, C <sub>OUT</sub> = 0.1 μF  47 μF, I <sub>ISO</sub> = 100 mA	
Switching Frequency	f <sub>SW</sub>	209	1000			kHz	R <sub>OC</sub> = 50 kΩ
			200			kHz	R <sub>OC</sub> = 270 kΩ
			318	515		kHz	V <sub>OC</sub> = V <sub>DD2</sub> (open loop)
Switch On-Resistance	R <sub>ON</sub>		0.5		Ω		
<b>Undervoltage Lockout, V<sub>CC</sub>, V<sub>DD2</sub> Supplies</b>							
Positive Going Threshold	V <sub>UV+</sub>		2.8		V		
Negative Going Threshold	V <sub>UV-</sub>		2.6		V		
Hysteresis	V <sub>UVH</sub>		0.2		V		
<b>iCoupler DATA CHANNELS</b>							
<b>DC to 2 Mbps Data Rate<sup>1</sup></b>							
Maximum Output Supply Current <sup>2</sup>	I <sub>ISO (MAX)</sub>	400			mA	f ≤ 1 MHz, V <sub>ISO</sub> = 3.3 V	
Efficiency at Maximum Output Supply Current <sup>3</sup>			70		%	I <sub>ISO</sub> = I <sub>ISO (MAX)</sub> , f ≤ 1 MHz	
<b>I<sub>CC</sub> Supply Current, No V<sub>ISO</sub> Load</b>							
ADuM3470	I <sub>CC (Q)</sub>		9	30	mA	I <sub>ISO</sub> = 0 mA, f ≤ 1 MHz	
ADuM3471			9	30	mA		
ADuM3472			10	30	mA		
ADuM3473			10	30	mA		
ADuM3474			10	30	mA		
<b>25 Mbps Data Rate (CRWZ Grade Only)</b>							
<b>I<sub>CC</sub> Supply Current, No V<sub>ISO</sub> Load</b>							
ADuM3470	I <sub>CC (D)</sub>		33		mA	I <sub>ISO</sub> = 0 mA, C <sub>L</sub> = 15 pF, f = 12.5 MHz	
ADuM3471			33		mA	I <sub>ISO</sub> = 0 mA, C <sub>L</sub> = 15 pF, f = 12.5 MHz	
ADuM3472			33		mA	I <sub>ISO</sub> = 0 mA, C <sub>L</sub> = 15 pF, f = 12.5 MHz	
ADuM3473			33		mA	I <sub>ISO</sub> = 0 mA, C <sub>L</sub> = 15 pF, f = 12.5 MHz	
ADuM3474			33		mA	I <sub>ISO</sub> = 0 mA, C <sub>L</sub> = 15 pF, f = 12.5 MHz	
<b>Available V<sub>ISO</sub> Supply Current<sup>4</sup></b>							
ADuM3470	I <sub>ISO (LOAD)</sub>		393		mA	C <sub>L</sub> = 15 pF, f = 12.5 MHz	
ADuM3471			392		mA	C <sub>L</sub> = 15 pF, f = 12.5 MHz	
ADuM3472			390		mA	C <sub>L</sub> = 15 pF, f = 12.5 MHz	
ADuM3473			389		mA	C <sub>L</sub> = 15 pF, f = 12.5 MHz	
ADuM3474			388		mA	C <sub>L</sub> = 15 pF, f = 12.5 MHz	
<b>I<sub>CC</sub> Supply Current, Full V<sub>ISO</sub> Load</b>							
	I <sub>CC (MAX)</sub>		375		mA	C <sub>L</sub> = 0 pF, f = 0 MHz, V <sub>DD</sub> = 5 V, I <sub>ISO</sub> = 400 mA	
<b>I/O Input Currents</b>							
Logic High Input Threshold	I <sub>IA</sub> , I <sub>IB</sub> , I <sub>IC</sub> , I <sub>ID</sub>	-20	+0.01	+20	μA		
Logic Low Input Threshold	V <sub>IH</sub>	2.0			V		
	V <sub>IL</sub>			0.8	V		

# ADuM3470/ADuM3471/ADuM3472/ADuM3473/ADuM3474

Parameter	Symbol	Min	Typ	Max	Unit	Test Conditions/Comments
Logic High Output Voltages	$V_{OAH}, V_{OBH}, V_{OCH}, V_{ODH}$	$V_{CC} - 0.3, V_{ISO} - 0.3$	5.0		V	$I_{Ox} = -20 \mu A, V_{Ix} = V_{IxH}$
Logic Low Output Voltages	$V_{OAL}, V_{OBL}, V_{OCL}, V_{ODL}$	$V_{CC} - 0.5, V_{ISO} - 0.3$	4.8		V	$I_{Ox} = -4 \text{ mA}, V_{Ix} = V_{IxH}$
			0.0	0.1	V	$I_{Ox} = 20 \mu A, V_{Ix} = V_{IxL}$
			0.0	0.4	V	$I_{Ox} = 4 \text{ mA}, V_{Ix} = V_{IxL}$
<b>AC SPECIFICATIONS</b>						
<b>ADuM347xARWZ</b>						
Minimum Pulse Width	PW			1000	ns	$C_L = 15 \text{ pF}$ , CMOS signal levels
Maximum Data Rate		1			Mbps	$C_L = 15 \text{ pF}$ , CMOS signal levels
Propagation Delay	$t_{PHL}, t_{PLH}$		55	100	ns	$C_L = 15 \text{ pF}$ , CMOS signal levels
Pulse Width Distortion, $ t_{PLH} - t_{PHL} $	PWD			40	ns	$C_L = 15 \text{ pF}$ , CMOS signal levels
Propagation Delay Skew	$t_{PSK}$			50	ns	$C_L = 15 \text{ pF}$ , CMOS signal levels
Channel-to-Channel Matching	$t_{PSKCD}/t_{PSKOD}$			50	ns	$C_L = 15 \text{ pF}$ , CMOS signal levels
<b>ADuM347xCRWZ</b>						
Minimum Pulse Width	PW			40	ns	$C_L = 15 \text{ pF}$ , CMOS signal levels
Maximum Data Rate		25			Mbps	$C_L = 15 \text{ pF}$ , CMOS signal levels
Propagation Delay	$t_{PHL}, t_{PLH}$	30	50	70	ns	$C_L = 15 \text{ pF}$ , CMOS signal levels
Pulse Width Distortion, $ t_{PLH} - t_{PHL} $	PWD			8	ns	$C_L = 15 \text{ pF}$ , CMOS signal levels
Change vs. Temperature			5		ps/°C	$C_L = 15 \text{ pF}$ , CMOS signal levels
Propagation Delay Skew	$t_{PSK}$			15	ns	$C_L = 15 \text{ pF}$ , CMOS signal levels
Channel-to-Channel Matching, Codirectional Channels	$t_{PSKCD}$			8	ns	$C_L = 15 \text{ pF}$ , CMOS signal levels
Channel-to-Channel Matching, Opposing Directional Channels	$t_{PSKOD}$			15	ns	$C_L = 15 \text{ pF}$ , CMOS signal levels
Output Rise/Fall Time (10% to 90%)	$t_R/t_F$		2.5		ns	$C_L = 15 \text{ pF}$ , CMOS signal levels
Common-Mode Transient Immunity at Logic High Output	$ CM_H $	25	35		kV/ $\mu s$	$V_{Ix} = V_{DD}$ or $V_{ISO}$ , $V_{CM} = 1000 \text{ V}$ , transient magnitude = 800 V
Common-Mode Transient Immunity at Logic Low Output	$ CM_L $	25	35		kV/ $\mu s$	$V_{Ix} = 0 \text{ V}$ , $V = 1000 \text{ V}$ , transient magnitude = 800 V
Refresh Rate	$f_r$		1.0		Mbps	

<sup>1</sup> The contributions of supply current values for all four channels are combined at identical data rates.

<sup>2</sup> The  $V_{ISO}$  supply current is available for external use when all data rates are below 2 Mbps. At data rates above 2 Mbps, the data I/O channels draw additional current proportional to the data rate. Additional supply current associated with an individual channel operating at a given data rate can be calculated as described in the Power Consumption section. The dynamic I/O channel load must be treated as an external load and included in the  $V_{ISO}$  power budget.

<sup>3</sup> The power demands of the quiescent operation of the data channels was not separated from the power supply section. Efficiency includes the quiescent power consumed by the I/O channels as part of the internal power consumption.

<sup>4</sup> This current is available for driving external loads at the  $V_{ISO}$  output. All channels are simultaneously driven at a maximum data rate of 25 Mbps with full capacitive load representing the maximum dynamic load conditions. Refer to the Power Consumption section for calculation of available current at less than the maximum data rate.



# ADuM3470/ADuM3471/ADuM3472/ADuM3473/ADuM3474

## ELECTRICAL CHARACTERISTICS—5 V PRIMARY INPUT SUPPLY/15 V SECONDARY ISOLATED SUPPLY

4.5 V ≤ (V<sub>DD1</sub> = V<sub>DDA</sub>) ≤ 5.5 V; V<sub>REG</sub> = V<sub>ISO</sub> = 15 V; V<sub>DD2</sub> = 5.0 V; f<sub>SW</sub> = 500 kHz; all voltages are relative to their respective grounds; see the application schematic in Figure 39. All minimum/maximum specifications apply over the entire recommended operating range, unless otherwise noted. All typical specifications are at T<sub>A</sub> = 25°C, V<sub>DD1</sub> = V<sub>DDA</sub> = 5.0 V, V<sub>REG</sub> = V<sub>ISO</sub> = 15 V, V<sub>DD2</sub> = 5.0 V.

**Table 4.**

Parameter	Symbol	Min	Typ	Max	Unit	Test Conditions/Comments
<b>DC-TO-DC CONVERTER POWER SUPPLY</b>						
Isolated Output Voltage	V <sub>ISO</sub>	13.8	15	16.2	V	I <sub>ISO</sub> = 0 mA, V <sub>ISO</sub> = V <sub>FB</sub> × (R1 + R2)/R2
Feedback Voltage Setpoint	V <sub>FB</sub>	1.15	1.25	1.35	V	I <sub>ISO</sub> = 0 mA
<b>V<sub>DD2</sub> Linear Regulator</b>						
Regulator Voltage	V <sub>DD2</sub>	4.6	5.0	5.4	V	V <sub>REG</sub> = 7 V to 15 V, I <sub>DD2</sub> = 0 mA to 50 mA
Dropout Voltage	V <sub>DD2DO</sub>		0.5	1.5	V	I <sub>DD2</sub> = 50 mA
Line Regulation	V <sub>ISO(LINE)</sub>		1	10	mV/V	I <sub>ISO</sub> = 50 mA, V <sub>CC</sub> = 4.5 V to 5.5 V
Load Regulation	V <sub>ISO(LOAD)</sub>		1	3	%	I <sub>ISO</sub> = 20 mA to 100 mA
Output Ripple	V <sub>ISO(RIP)</sub>		200		mV p-p	20 MHz bandwidth, C <sub>OUT</sub> = 0.1 μF  47 μF, I <sub>ISO</sub> = 100 mA
Output Noise	V <sub>ISO(N)</sub>		500		mV p-p	20 MHz bandwidth, C <sub>OUT</sub> = 0.1 μF  47 μF, I <sub>ISO</sub> = 100 mA
Switching Frequency	f <sub>SW</sub>		1000		kHz	R <sub>OC</sub> = 50 kΩ
			200		kHz	R <sub>OC</sub> = 270 kΩ
		192	318	515	kHz	V <sub>OC</sub> = V <sub>DD2</sub> (open loop)
Switch On-Resistance	R <sub>ON</sub>		0.5		Ω	
<b>Undervoltage Lockout, V<sub>CC</sub>, V<sub>DD2</sub> Supplies</b>						
Positive Going Threshold	V <sub>UV+</sub>		2.8		V	
Negative Going Threshold	V <sub>UV-</sub>		2.6		V	
Hysteresis	V <sub>UVH</sub>		0.2		V	
<b>iCoupler DATA CHANNELS</b>						
<b>DC to 2 Mbps Data Rate<sup>1</sup></b>						
Maximum Output Supply Current <sup>2</sup>	I <sub>ISO(MAX)</sub>	100			mA	f ≤ 1 MHz, V <sub>ISO</sub> = 5.0 V
Efficiency at Maximum Output Supply Current <sup>3</sup>			70		%	I <sub>ISO</sub> = I <sub>ISO(MAX)</sub> , f ≤ 1 MHz
I <sub>CC</sub> Supply Current, No V <sub>ISO</sub> Load	I <sub>CC(Q)</sub>					I <sub>ISO</sub> = 0 mA, f ≤ 1 MHz
ADuM3470			25	45	mA	
ADuM3471			27	45	mA	
ADuM3472			29	45	mA	
ADuM3473			31	45	mA	
ADuM3474			33	45	mA	
<b>25 Mbps Data Rate (CRWZ Grade Only)</b>						
I <sub>CC</sub> Supply Current, No V <sub>ISO</sub> Load	I <sub>CC(D)</sub>					
ADuM3470			73		mA	I <sub>ISO</sub> = 0 mA, C <sub>L</sub> = 15 pF, f = 12.5 MHz
ADuM3471			83		mA	I <sub>ISO</sub> = 0 mA, C <sub>L</sub> = 15 pF, f = 12.5 MHz
ADuM3472			93		mA	I <sub>ISO</sub> = 0 mA, C <sub>L</sub> = 15 pF, f = 12.5 MHz
ADuM3473			102		mA	I <sub>ISO</sub> = 0 mA, C <sub>L</sub> = 15 pF, f = 12.5 MHz
ADuM3474			112		mA	I <sub>ISO</sub> = 0 mA, C <sub>L</sub> = 15 pF, f = 12.5 MHz
Available V <sub>ISO</sub> Supply Current <sup>4</sup>	I <sub>ISO(LOAD)</sub>					
ADuM3470			91		mA	C <sub>L</sub> = 15 pF, f = 12.5 MHz
ADuM3471			89		mA	C <sub>L</sub> = 15 pF, f = 12.5 MHz
ADuM3472			86		mA	C <sub>L</sub> = 15 pF, f = 12.5 MHz
ADuM3473			83		mA	C <sub>L</sub> = 15 pF, f = 12.5 MHz
ADuM3474			80		mA	C <sub>L</sub> = 15 pF, f = 12.5 MHz
I <sub>CC</sub> Supply Current, Full V <sub>ISO</sub> Load	I <sub>CC(MAX)</sub>		425		mA	C <sub>L</sub> = 0 pF, f = 0 MHz, V <sub>DD</sub> = 5 V, I <sub>ISO</sub> = 100 mA
<b>I/O Input Currents</b>						
Logic High Input Threshold	V <sub>IH</sub>	2.0	+0.01	+20	V	
Logic Low Input Threshold	V <sub>IL</sub>			0.8	V	

# ADuM3470/ADuM3471/ADuM3472/ADuM3473/ADuM3474

Parameter	Symbol	Min	Typ	Max	Unit	Test Conditions/Comments
Logic High Output Voltages	$V_{OAH}, V_{OBH}, V_{OCH}, V_{ODH}$	$V_{CC} - 0.3, V_{ISO} - 0.3$	5.0		V	$I_{Ox} = -20 \mu A, V_{ix} = V_{ixH}$
Logic Low Output Voltages	$V_{OAL}, V_{OBL}, V_{OCL}, V_{ODL}$	$V_{CC} - 0.5, V_{ISO} - 0.3$	4.8		V	$I_{Ox} = -4 \text{ mA}, V_{ix} = V_{ixH}$
			0.0	0.1	V	$I_{Ox} = 20 \mu A, V_{ix} = V_{ixL}$
			0.0	0.4	V	$I_{Ox} = 4 \text{ mA}, V_{ix} = V_{ixL}$
<b>AC SPECIFICATIONS</b>						
<b>ADuM347xARWZ</b>						
Minimum Pulse Width	PW			1000	ns	$C_L = 15 \text{ pF}$ , CMOS signal levels
Maximum Data Rate		1			Mbps	$C_L = 15 \text{ pF}$ , CMOS signal levels
Propagation Delay	$t_{PHL}, t_{PLH}$		55	100	ns	$C_L = 15 \text{ pF}$ , CMOS signal levels
Pulse Width Distortion, $ t_{PLH} - t_{PHL} $	PWD			40	ns	$C_L = 15 \text{ pF}$ , CMOS signal levels
Propagation Delay Skew	$t_{PSK}$			50	ns	$C_L = 15 \text{ pF}$ , CMOS signal levels
Channel-to-Channel Matching	$t_{PSKCD}/t_{PSKOD}$			50	ns	$C_L = 15 \text{ pF}$ , CMOS signal levels
<b>ADuM347xCRWZ</b>						
Minimum Pulse Width	PW			40	ns	$C_L = 15 \text{ pF}$ , CMOS signal levels
Maximum Data Rate		25			Mbps	$C_L = 15 \text{ pF}$ , CMOS signal levels
Propagation Delay	$t_{PHL}, t_{PLH}$	30	45	60	ns	$C_L = 15 \text{ pF}$ , CMOS signal levels
Pulse Width Distortion, $ t_{PLH} - t_{PHL} $	PWD			6	ns	$C_L = 15 \text{ pF}$ , CMOS signal levels
Change vs. Temperature			5		ps/°C	$C_L = 15 \text{ pF}$ , CMOS signal levels
Propagation Delay Skew	$t_{PSK}$			15	ns	$C_L = 15 \text{ pF}$ , CMOS signal levels
Channel-to-Channel Matching, Codirectional Channels	$t_{PSKCD}$			6	ns	$C_L = 15 \text{ pF}$ , CMOS signal levels
Channel-to-Channel Matching, Opposing Directional Channels	$t_{PSKOD}$			15	ns	$C_L = 15 \text{ pF}$ , CMOS signal levels
Output Rise/Fall Time (10% to 90%)	$t_R/t_F$		2.5		ns	$C_L = 15 \text{ pF}$ , CMOS signal levels
Common-Mode Transient Immunity at Logic High Output	$ CM_H $	25	35		kV/ $\mu$ s	$V_{ix} = V_{DD}$ or $V_{ISO}$ , $V_{CM} = 1000 \text{ V}$ , transient magnitude = 800 V
Common-Mode Transient Immunity at Logic Low Output	$ CM_L $	25	35		kV/ $\mu$ s	$V_{ix} = 0 \text{ V}$ , $V = 1000 \text{ V}$ , transient magnitude = 800 V
Refresh Rate	$f_r$		1.0		Mbps	

<sup>1</sup> The contributions of supply current values for all four channels are combined at identical data rates.

<sup>2</sup> The  $V_{ISO}$  supply current is available for external use when all data rates are below 2 Mbps. At data rates above 2 Mbps, the data I/O channels draw additional current proportional to the data rate. Additional supply current associated with an individual channel operating at a given data rate can be calculated as described in the Power Consumption section. The dynamic I/O channel load must be treated as an external load and included in the  $V_{ISO}$  power budget.

<sup>3</sup> The power demands of the quiescent operation of the data channels was not separated from the power supply section. Efficiency includes the quiescent power consumed by the I/O channels as part of the internal power consumption.

<sup>4</sup> This current is available for driving external loads at the  $V_{ISO}$  output. All channels are simultaneously driven at a maximum data rate of 25 Mbps with full capacitive load representing the maximum dynamic load conditions. Refer to the Power Consumption section for calculation of available current at less than the maximum data rate.

# ADuM3470/ADuM3471/ADuM3472/ADuM3473/ADuM3474

## PACKAGE CHARACTERISTICS

Table 5.

Parameter	Symbol	Min	Typ	Max	Unit	Test Conditions/Comments
Resistance (Input to Output) <sup>1</sup>	R <sub>I-O</sub>		10 <sup>12</sup>		Ω	
Capacitance (Input to Output) <sup>1</sup>	C <sub>I-O</sub>		2.2		pF	f = 1 MHz
Input Capacitance <sup>2</sup>	C <sub>i</sub>		4.0		pF	
IC Junction to Ambient Thermal Resistance	θ <sub>JA</sub>		50.5		°C/W	Thermocouple located at center of package underside, test conducted on 4-layer board with thin traces <sup>3</sup>
Thermal Shutdown						
Thermal Shutdown Threshold	TS <sub>SD</sub>		150		°C	T <sub>J</sub> rising
Thermal Shutdown Hysteresis	TS <sub>SD-HYS</sub>		20		°C	

<sup>1</sup> The device is considered a 2-terminal device: Pin 1 to Pin 8 is shorted together; and Pin 9 to Pin 16 is shorted together.

<sup>2</sup> Input capacitance is from any input data pin to ground.

<sup>3</sup> See the Thermal Analysis section for thermal model definitions.

## REGULATORY APPROVALS (PENDING)

Table 6.

UL	CSA	VDE
Recognized under the UL 1577 component recognition program <sup>1</sup>	Approved under CSA Component Acceptance Notice #5A	Certified according to DIN V VDE V 0884-10 (VDE V 0884-10):2006-12 <sup>2</sup>
Single protection, 2500 V rms isolation voltage	Basic insulation per CSA 60950-1-03 and IEC 60950-1, 600 V rms (848 V peak) maximum working voltage	Reinforced insulation, 560 V peak
File E214100	File 205078	File 2471900-4880-0001

<sup>1</sup> In accordance with UL 1577, each ADuM3470/ADuM3471/ADuM3472/ADuM3473/ADuM3474 is proof tested by applying an insulation test voltage of ≥3000 V rms for 1 sec (current leakage detection limit = 10 μA).

<sup>2</sup> In accordance with DIN V VDE V 0884-10, each of the ADuM347x is proof tested by applying an insulation test voltage of ≥1050 V peak for 1 sec (partial discharge detection limit = 5 pC). The asterisk (\*) marking branded on the component designates DIN V VDE V 0884-10 approval.

## INSULATION AND SAFETY-RELATED SPECIFICATIONS

Table 7.

Parameter	Symbol	Value	Unit	Test Conditions/Comments
Rated Dielectric Insulation Voltage		2500	V rms	1-minute duration
Minimum External Air Gap (Clearance)	L(I01)	>5.1	mm	Measured from input terminals to output terminals, shortest distance through air
Minimum External Tracking (Creepage)	L(I02)	>5.1	mm	Measured from input terminals to output terminals, shortest distance path along body
Minimum Internal Gap (Internal Clearance)		0.017 min	mm	Distance through insulation
Tracking Resistance (Comparative Tracking Index)	CTI	>400	V	DIN IEC 112/VDE 0303 Part 1
Isolation Group		II		Material Group (DIN VDE 0110, 1/89, Table 1)

# ADuM3470/ADuM3471/ADuM3472/ADuM3473/ADuM3474

## DIN V VDE V 0884-10 (VDE V 0884-10) INSULATION CHARACTERISTICS

These isolators are suitable for reinforced electrical isolation only within the safety limit data. Maintenance of the safety data is ensured by protective circuits. The asterisk (\*) marking on packages denotes DIN V VDE V 0884-10 approval.

Table 8.

Description	Test Conditions/Comments	Symbol	Characteristic	Unit
Installation Classification per DIN VDE 0110 For Rated Mains Voltage ≤ 150 V rms For Rated Mains Voltage ≤ 300 V rms For Rated Mains Voltage ≤ 400 V rms			I to IV I to III I to II	
Climatic Classification			40/105/21	
Pollution Degree per DIN VDE 0110, Table 1			2	
Maximum Working Insulation Voltage		$V_{IORM}$	560	V peak
Input-to-Output Test Voltage, Method B1	$V_{IORM} \times 1.875 = V_{PR}$ , 100% production test, $t_m = 1$ sec, partial discharge < 5 pC	$V_{PR}$	1050	V peak
Input-to-Output Test Voltage, Method A		$V_{PR}$		
After Environmental Tests Subgroup 1	$V_{IORM} \times 1.6 = V_{PR}$ , $t_m = 60$ sec, partial discharge < 5 pC		896	V peak
After Input and/or Safety Test Subgroup 2 and Subgroup 3	$V_{IORM} \times 1.2 = V_{PR}$ , $t_m = 60$ sec, partial discharge < 5 pC		672	V peak
Highest Allowable Overvoltage	Transient overvoltage, $t_{TR} = 10$ sec	$V_{TR}$	4000	V peak
Safety Limiting Values	Maximum value allowed in the event of a failure (see Figure 3)			
Case Temperature		$T_S$	150	°C
Side 1 Current		$I_{S1}$	1.25	A
Insulation Resistance at $T_S$	$V_{IO} = 500$ V	$R_S$	>10 <sup>9</sup>	Ω

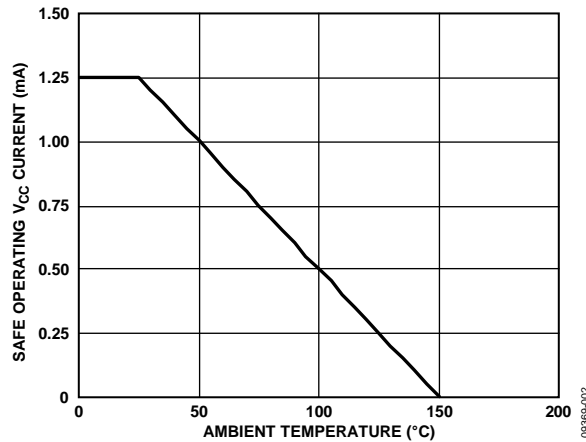

Figure 3. Thermal Derating Curve, Dependence of Safety Limiting Values on Case Temperature, per DIN EN 60747-5-2

## RECOMMENDED OPERATING CONDITIONS

Table 9.

Parameter	Symbol	Min	Max	Unit
Operating Temperature	$T_A$	-40	+105	°C
Supply Voltages <sup>1</sup>				
$V_{CC}$ at $V_{ISO} = 3.3$ V	$V_{CC}$	3.0	3.6	V
$V_{CC}$ at $V_{ISO} = 5.0$ V	$V_{CC}$	3.0	3.6	V
$V_{CC}$ at $V_{ISO} = 5.0$ V	$V_{CC}$	4.5	5.5	V
Minimum Load	$I_{ISO (MIN)}$	10		mA

<sup>1</sup> All voltages are relative to their respective grounds.

## ABSOLUTE MAXIMUM RATINGS

Ambient temperature = 25°C, unless otherwise noted.

**Table 10.**

Parameter	Rating
Storage Temperature Range (T <sub>ST</sub> )	–55°C to +150°C
Ambient Operating Temperature Range (T <sub>A</sub> )	–40°C to +105°C
Supply Voltages	
V <sub>DD1</sub> , V <sub>DDA</sub> , V <sub>DD2</sub> <sup>1</sup>	–0.5 V to +7.0 V
V <sub>REG</sub> , X1, X2 <sup>1</sup>	–0.5 V to +20.0 V
Input Voltage (V <sub>IA</sub> , V <sub>IB</sub> , V <sub>IC</sub> , V <sub>ID</sub> ) <sup>1, 2</sup>	–0.5 V to V <sub>DD1</sub> + 0.5 V
Output Voltage (V <sub>OA</sub> , V <sub>OB</sub> , V <sub>OC</sub> , V <sub>OD</sub> ) <sup>1, 2</sup>	–0.5 V to V <sub>DDO</sub> + 0.5 V
Average Output Current per Pin <sup>3</sup>	–10 mA to +10 mA
Common-Mode Transients <sup>4</sup>	–100 kV/μs to +100 kV/μs

<sup>1</sup> All voltages are relative to their respective ground.

<sup>2</sup> V<sub>DD1</sub> and V<sub>DDO</sub> refer to the supply voltages on the input and output sides of a given channel, respectively. See the Printed Circuit Board (PCB) Layout section.

<sup>3</sup> See Figure 3 for maximum rated current values for various temperatures.

<sup>4</sup> Refers to common-mode transients across the insulation barrier. Common-mode transients exceeding the absolute maximum ratings may cause latch-up or permanent damage.

Stresses above those listed under Absolute Maximum Ratings may cause permanent damage to the device. This is a stress rating only; functional operation of the device at these or any other conditions above those indicated in the operational section of this specification is not implied. Exposure to absolute maximum rating conditions for extended periods may affect device reliability.

**Table 11. Maximum Continuous Working Voltage Supporting 50-Year Minimum Lifetime<sup>1</sup>**

Parameter	Max	Unit	Applicable Certification
AC Voltage, Bipolar Waveform	565	V peak	All certifications
AC Voltage, Unipolar Waveform			
Basic Insulation	848	V peak	Working voltage per IEC 60950-1
DC Voltage			
Basic Insulation	848	V peak	Working voltage per IEC 60950-1

<sup>1</sup> Refers to the continuous voltage magnitude imposed across the isolation barrier. See the Insulation Lifetime section for more information.

### ESD CAUTION



**ESD (electrostatic discharge) sensitive device.** Charged devices and circuit boards can discharge without detection. Although this product features patented or proprietary protection circuitry, damage may occur on devices subjected to high energy ESD. Therefore, proper ESD precautions should be taken to avoid performance degradation or loss of functionality.

# ADuM3470/ADuM3471/ADuM3472/ADuM3473/ADuM3474

## PIN CONFIGURATIONS AND FUNCTION DESCRIPTIONS

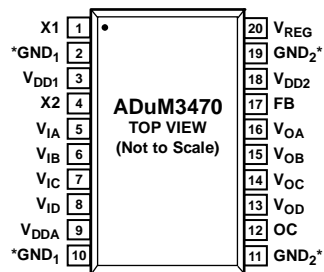

\*PIN 2 AND PIN 10 ARE INTERNALLY CONNECTED, AND CONNECTING BOTH TO GND<sub>1</sub> IS RECOMMENDED. PIN 11 AND PIN 19 ARE INTERNALLY CONNECTED, AND CONNECTING BOTH TO GND<sub>2</sub> IS RECOMMENDED.

09365-004

Figure 4. ADuM3470 Pin Configuration

Table 12. ADuM3470 Pin Function Descriptions

Pin No.	Mnemonic	Description
1	X1	Transformer Driver Output 1.
2, 10	GND <sub>1</sub>	Ground 1. Ground reference for isolator primary.
3	V <sub>DD1</sub>	Transformer Driver Supply Voltage 3.0 V to 5.5 V. Connect to V <sub>D<sub>DDA</sub></sub> pin. Connect a 10 μF bypass capacitor from V <sub>DD1</sub> to GND <sub>1</sub> .
4	X2	Transformer Driver Output 2.
5	V <sub>IA</sub>	Logic Input A.
6	V <sub>IB</sub>	Logic Input B.
7	V <sub>IC</sub>	Logic Input C.
8	V <sub>ID</sub>	Logic Input D.
9	V <sub>DDA</sub>	Primary Supply Voltage 3.0 V to 5.5 V. Connect to V <sub>DD1</sub> pin. Connect a 0.1 μF bypass capacitor from V <sub>DDA</sub> to GND <sub>1</sub> .
11, 19	GND <sub>2</sub>	Ground Reference for Isolator Side 2.
12	OC	Oscillator Control Pin. When OC = logic high = V <sub>DD2</sub> , the secondary controller runs open-loop. To regulate the output voltage, connect a resistor between the OC pin and GND <sub>2</sub> , and the secondary controller runs at a frequency of 200 kHz to 1 MHz, as programmed by the resistor value.
13	V <sub>OD</sub>	Logic Output D.
14	V <sub>OC</sub>	Logic Output C.
15	V <sub>OB</sub>	Logic Output B.
16	V <sub>OA</sub>	Logic Output A.
17	FB	Feedback Input from the Secondary Output Voltage V <sub>ISO</sub> . Use a resistor divider from V <sub>ISO</sub> to the FB pin to make the V <sub>FB</sub> voltage equal to the 1.25 V internal reference level using the $V_{FB} = V_{ISO} \times (R1 + R2)/R2$ formula. The resistor divider is required even in open-loop mode to provide soft start.
18	V <sub>DD2</sub>	The Internal Supply Voltage Pin for the Secondary Side Controller and Side 2 Data Channels. When a sufficient external voltage is supplied to V <sub>REG</sub> , the internal regulator regulates the V <sub>DD2</sub> pin to 5.0 V. Otherwise, V <sub>DD2</sub> should be in the 3.0 V to 5.5 V range. Connect a 0.1 μF bypass capacitor from V <sub>DD2</sub> to GND <sub>2</sub> .
20	V <sub>REG</sub>	The Input of the Internal Regulator to Power the Secondary Side Controller and Side 2 Data Channels. V <sub>REG</sub> should be in the 5.5 V to 15 V range to regulate the V <sub>DD2</sub> output to 5.0 V.

# ADuM3470/ADuM3471/ADuM3472/ADuM3473/ADuM3474

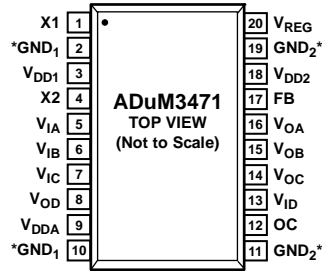

\*PIN 2 AND PIN 10 ARE INTERNALLY CONNECTED, AND CONNECTING BOTH TO GND<sub>1</sub> IS RECOMMENDED. PIN 11 AND PIN 19 ARE INTERNALLY CONNECTED, AND CONNECTING BOTH TO GND<sub>2</sub> IS RECOMMENDED.

09286-005

Figure 5. ADuM3471 Pin Configuration

Table 13. ADuM3471 Pin Function Descriptions

Pin No.	Mnemonic	Description
1	X1	Transformer Driver Output 1.
2, 10	GND <sub>1</sub>	Ground 1. Ground reference for isolator primary.
3	V <sub>DD1</sub>	Transformer Driver Supply Voltage 3.0 V to 5.5 V. Connect to V <sub>DDA</sub> pin. Connect a 10 μF bypass capacitor from V <sub>DD1</sub> to GND <sub>1</sub> .
4	X2	Transformer Driver Output 2.
5	V <sub>IA</sub>	Logic Input A.
6	V <sub>IB</sub>	Logic Input B.
7	V <sub>IC</sub>	Logic Input C.
8	V <sub>OD</sub>	Logic Output D.
9	V <sub>DDA</sub>	Primary Supply Voltage 3.0 V to 5.5 V. Connect to V <sub>DD1</sub> pin. Connect a 0.1 μF bypass capacitor from V <sub>DDA</sub> to GND <sub>1</sub> .
11, 19	GND <sub>2</sub>	Ground Reference for Isolator Side 2.
12	OC	Oscillator Control Pin. When OC = logic high = V <sub>DD2</sub> , the secondary controller runs open-loop. To regulate the output voltage, connect a resistor between the OC pin and GND <sub>2</sub> , and the secondary controller runs at a frequency of 200 kHz to 1 MHz, as programmed by the resistor value.
13	V <sub>ID</sub>	Logic Input D.
14	V <sub>OC</sub>	Logic Output C.
15	V <sub>OB</sub>	Logic Output B.
16	V <sub>OA</sub>	Logic Output A.
17	FB	Feedback Input from the Secondary Output Voltage V <sub>ISO</sub> . Use a resistor divider from V <sub>ISO</sub> to the FB pin to make the V <sub>FB</sub> voltage equal to the 1.25 V internal reference level using the $V_{ISO} = V_{FB} \times (R1 + R2)/R2$ formula. The resistor divider is required even in open-loop mode to provide soft start.
18	V <sub>DD2</sub>	The Internal Supply Voltage Pin for the Secondary Side Controller and Side 2 Data Channels. When a sufficient external voltage is supplied to V <sub>REG</sub> , the internal regulator regulates the V <sub>DD2</sub> pin to 5.0 V. Otherwise, V <sub>DD2</sub> should be in the 3.0 V to 5.5 V range. Connect a 0.1 μF bypass capacitor from V <sub>DD2</sub> to GND <sub>2</sub> .
20	V <sub>REG</sub>	The Input of the Internal Regulator to Power the Secondary Side Controller and Side 2 Data Channels. V <sub>REG</sub> should be in the 5.5 V to 15 V range to regulate the V <sub>DD2</sub> output to 5.0 V.

# ADuM3470/ADuM3471/ADuM3472/ADuM3473/ADuM3474

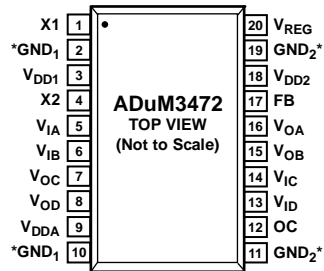

\*PIN 2 AND PIN 10 ARE INTERNALLY CONNECTED, AND CONNECTING BOTH TO GND<sub>1</sub> IS RECOMMENDED. PIN 11 AND PIN 19 ARE INTERNALLY CONNECTED, AND CONNECTING BOTH TO GND<sub>2</sub> IS RECOMMENDED.

09389-006

Figure 6. ADuM3472 Pin Configuration

Table 14. ADuM3472 Pin Function Descriptions

Pin No.	Mnemonic	Description
1	X1	Transformer Driver Output 1.
2, 10	GND <sub>1</sub>	Ground 1. Ground reference for isolator primary.
3	V <sub>DD1</sub>	Transformer Driver Supply Voltage 3.0 V to 5.5 V. Connect to V <sub>DDA</sub> pin. Connect a 10 μF bypass capacitor from V <sub>DD1</sub> to GND <sub>1</sub> .
4	X2	Transformer Driver Output 2.
5	V <sub>IA</sub>	Logic Input A.
6	V <sub>IB</sub>	Logic Input B.
7	V <sub>OC</sub>	Logic Output C.
8	V <sub>OD</sub>	Logic Output D.
9	V <sub>DDA</sub>	Primary Supply Voltage 3.0 V to 5.5 V. Connect to V <sub>DD1</sub> pin. Connect a 0.1 μF bypass capacitor from V <sub>DDA</sub> to GND <sub>1</sub> .
11, 19	GND <sub>2</sub>	Ground Reference for Isolator Side 2.
12	OC	Oscillator Control pin. When OC = logic high = V <sub>DD2</sub> , the secondary controller runs open-loop. To regulate the output voltage, connect a resistor between the OC pin and GND <sub>2</sub> , and the secondary controller runs at a frequency of 200 kHz to 1 MHz, as programmed by the resistor value.
13	V <sub>ID</sub>	Logic Input D.
14	V <sub>IC</sub>	Logic Input C.
15	V <sub>OB</sub>	Logic Output B.
16	V <sub>OA</sub>	Logic Output A.
17	FB	Feedback Input from the Secondary Output Voltage V <sub>ISO</sub> . Use a resistor divider from V <sub>ISO</sub> to the FB pin to make the V <sub>FB</sub> voltage equal to the 1.25 V internal reference level using the $V_{ISO} = V_{FB} \times (R1 + R2)/R2$ formula. The resistor divider is required even in open-loop mode to provide soft start.
18	V <sub>DD2</sub>	The Internal Supply Voltage Pin for the Secondary Side Controller and Side 2 Data Channels. When a sufficient external voltage is supplied to V <sub>REG</sub> , the internal regulator regulates the V <sub>DD2</sub> pin to 5.0 V. Otherwise, V <sub>DD2</sub> should be in the 3.0 V to 5.5 V range. Connect a 0.1 μF bypass capacitor from V <sub>DD2</sub> to GND <sub>2</sub> .
20	V <sub>REG</sub>	The Input of an Internal Regulator to Power the Secondary Side Controller and Side 2 Data Channels. V <sub>REG</sub> should be in the 5.5 V to 15 V range to regulate the V <sub>DD2</sub> output to 5.0 V.



# ADuM3470/ADuM3471/ADuM3472/ADuM3473/ADuM3474

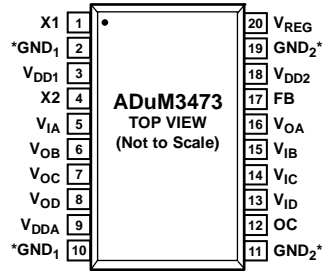

\*PIN 2 AND PIN 10 ARE INTERNALLY CONNECTED, AND CONNECTING BOTH TO GND<sub>1</sub> IS RECOMMENDED. PIN 11 AND PIN 19 ARE INTERNALLY CONNECTED, AND CONNECTING BOTH TO GND<sub>2</sub> IS RECOMMENDED.

09586-007

Figure 7. ADuM3473 Pin Configuration

Table 15. ADuM3473 Pin Function Descriptions

Pin No.	Mnemonic	Description
1	X1	Transformer Driver Output 1.
2, 10	GND <sub>1</sub>	Ground 1. Ground reference for isolator primary.
3	V <sub>DD1</sub>	Transformer Driver Supply Voltage 3.0 V to 5.5 V. Connect to V <sub>DDA</sub> pin. Connect a 10 μF bypass capacitor from V <sub>DD1</sub> to GND <sub>1</sub> .
4	X2	Transformer Driver Output 2.
5	V <sub>IA</sub>	Logic Input A.
6	V <sub>OB</sub>	Logic Output B.
7	V <sub>OC</sub>	Logic Output C.
8	V <sub>OD</sub>	Logic Output D.
9	V <sub>DDA</sub>	Primary Supply Voltage 3.0 V to 5.5 V. Connect to V <sub>DD1</sub> pin. Connect a 0.1 μF bypass capacitor from V <sub>DDA</sub> to GND <sub>1</sub> .
11, 19	GND <sub>2</sub>	Ground Reference for Isolator Side 2.
12	OC	Oscillator Control Pin. When OC = logic high = V <sub>DD2</sub> , the secondary controller runs open-loop. To regulate the output voltage, connect a resistor between the OC pin and GND <sub>2</sub> , and the secondary controller runs at a frequency of 200 kHz to 1 MHz, as programmed by the resistor value.
13	V <sub>ID</sub>	Logic Input D.
14	V <sub>IC</sub>	Logic Input C.
15	V <sub>IB</sub>	Logic Input B.
16	V <sub>OA</sub>	Logic Output A.
17	FB	Feedback Input from the Secondary Output Voltage V <sub>ISO</sub> . Use a resistor divider from V <sub>ISO</sub> to the FB pin to make the V <sub>FB</sub> voltage equal to the 1.25 V internal reference level using the $V_{ISO} = V_{FB} \times (R1 + R2)/R2$ formula. The resistor divider is required even in open-loop mode to provide soft start.
18	V <sub>DD2</sub>	The Internal Supply Voltage Pin for the Secondary Side Controller and Side 2 Data Channels. When a sufficient external voltage is supplied to V <sub>REG</sub> , the internal regulator regulates the V <sub>DD2</sub> pin to 5.0 V. Otherwise, V <sub>DD2</sub> should be in the 3.0 V to 5.5 V range. Connect a 0.1 μF bypass capacitor from V <sub>DD2</sub> to GND <sub>2</sub> .
20	V <sub>REG</sub>	The Input of an Internal Regulator to Power the Secondary Side Controller and Side 2 Data Channels. V <sub>REG</sub> should be in the 5.5 V to 15 V range to regulate the V <sub>DD2</sub> output to 5.0 V.

# ADuM3470/ADuM3471/ADuM3472/ADuM3473/ADuM3474

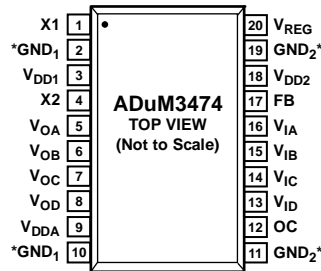

\*PIN 2 AND PIN 10 ARE INTERNALLY CONNECTED, AND CONNECTING BOTH TO GND<sub>1</sub> IS RECOMMENDED. PIN 11 AND PIN 19 ARE INTERNALLY CONNECTED, AND CONNECTING BOTH TO GND<sub>2</sub> IS RECOMMENDED.

09386-008

Figure 8. ADuM3474 Pin Configuration

Table 16. ADuM3474 Pin Function Descriptions

Pin No.	Mnemonic	Description
1	X1	Transformer Driver Output 1.
2, 10	GND <sub>1</sub>	Ground 1. Ground reference for isolator primary.
3	V <sub>DD1</sub>	Transformer Driver Supply Voltage 3.0 V to 5.5 V. Connect to V <sub>DDA</sub> pin. Connect a 10 μF bypass capacitor from V <sub>DD1</sub> to GND <sub>1</sub> .
4	X2	Transformer Driver Output 2.
5	V <sub>OA</sub>	Logic Output A.
6	V <sub>OB</sub>	Logic Output B.
7	V <sub>OC</sub>	Logic Output C.
8	V <sub>OD</sub>	Logic Output D.
9	V <sub>DDA</sub>	Primary Supply Voltage 3.0 V to 5.5 V. Connect to V <sub>DD1</sub> pin. Connect a 0.1 μF bypass capacitor from V <sub>DDA</sub> to GND <sub>1</sub> .
11, 19	GND <sub>2</sub>	Ground Reference for Isolator Side 2.
12	OC	Oscillator Control Pin. When OC = logic high = V <sub>DD2</sub> , the secondary controller runs open-loop. To regulate the output voltage, connect a resistor between the OC pin and GND <sub>2</sub> , and the secondary controller runs at a frequency of 200 kHz to 1 MHz, as programmed by the resistor value.
13	V <sub>ID</sub>	Logic Input D.
14	V <sub>IC</sub>	Logic Input C.
15	V <sub>IB</sub>	Logic Input B.
16	V <sub>IA</sub>	Logic Input A.
17	FB	Feedback Input from the Secondary Output Voltage V <sub>ISO</sub> . Use a resistor divider from V <sub>ISO</sub> to the FB pin to make the V <sub>FB</sub> voltage equal to the 1.25 V internal reference level using the $V_{ISO} = V_{FB} \times (R1 + R2)/R2$ formula. The resistor divider is required even in open-loop mode to provide soft start.
18	V <sub>DD2</sub>	The Internal Supply Voltage Pin for the Secondary Side Controller and Side 2 Data Channels. When a sufficient external voltage is supplied to V <sub>REG</sub> , the internal regulator regulates the V <sub>DD2</sub> pin to 5.0 V. Otherwise, V <sub>DD2</sub> should be in the 3.0 V to 5.5 V range. Connect a 0.1 μF bypass capacitor from V <sub>DD2</sub> to GND <sub>2</sub> .
20	V <sub>REG</sub>	The input of an internal regulator used to power the secondary side controller and Side 2 data channels. V <sub>REG</sub> should be in the 5.5 V to 15 V range to regulate the V <sub>DD2</sub> output to 5.0 V.

Table 17. Truth Table (Positive Logic)

V <sub>ix</sub> Input <sup>1</sup>	V <sub>CC</sub> State	V <sub>DD2</sub> State	V <sub>ox</sub> Output <sup>1</sup>	Notes
High	Powered	Powered	High	Normal operation, data is high
Low	Powered	Powered	Low	Normal operation, data is low

<sup>1</sup> V<sub>ix</sub> and V<sub>ox</sub> refer to the input and output signals of a given channel (A, B, C, or D).

## TYPICAL PERFORMANCE CHARACTERISTICS

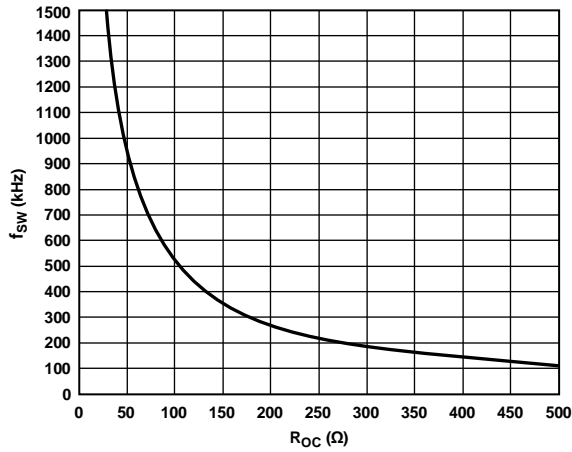

Figure 9. Switching Frequency ( $f_{sw}$ ) vs.  $R_{OC}$  Resistance

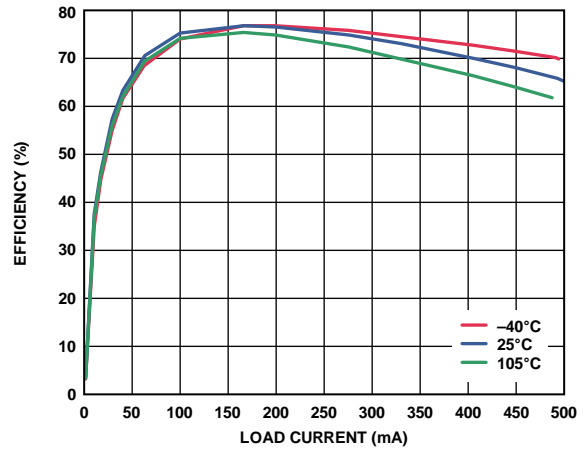

Figure 12. 5 V In to 5 V Out Efficiency over Temperature with Coilcraft Transformer at 500 kHz  $f_{sw}$

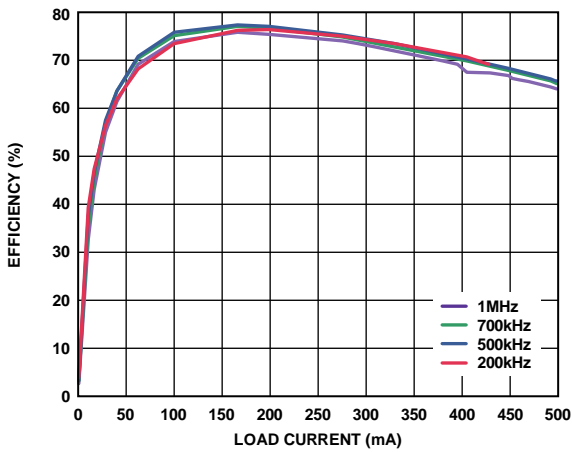

Figure 10. Typical Efficiency at 5 V In to 5 V Out at Various Switching Frequencies with Coilcraft Transformer

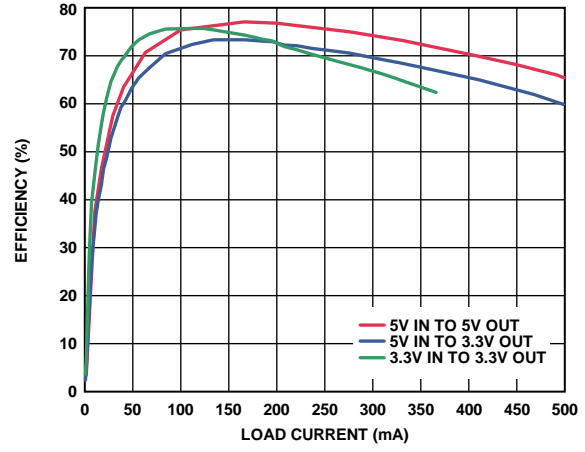

Figure 13. Single-Supply Efficiency with Coilcraft Transformer at 500 kHz  $f_{sw}$

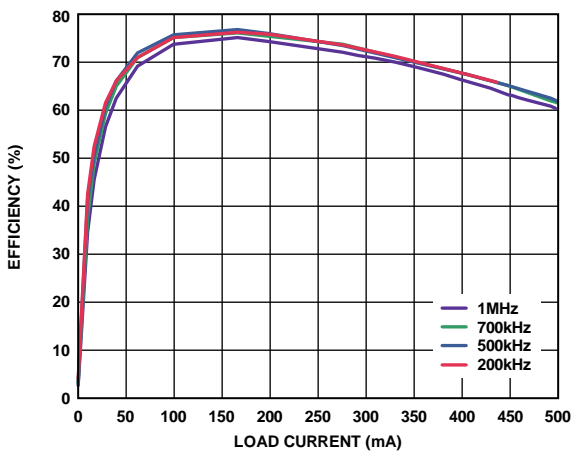

Figure 11. Typical Efficiency at 5 V In to 5 V Out at Various Switching Frequencies with Halo Transformer

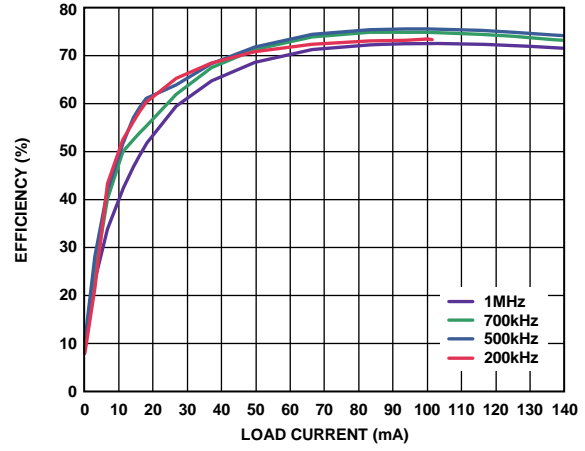

Figure 14. 5 V In to 15 V Out Efficiency at Various Switching Frequencies with Coilcraft Transformer

# ADuM3470/ADuM3471/ADuM3472/ADuM3473/ADuM3474

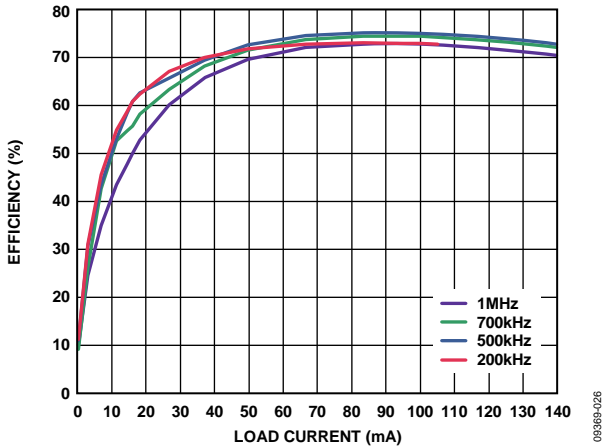

Figure 15. 5 V In to 15 V Out Efficiency at Various Switching Frequencies with Halo Transformer

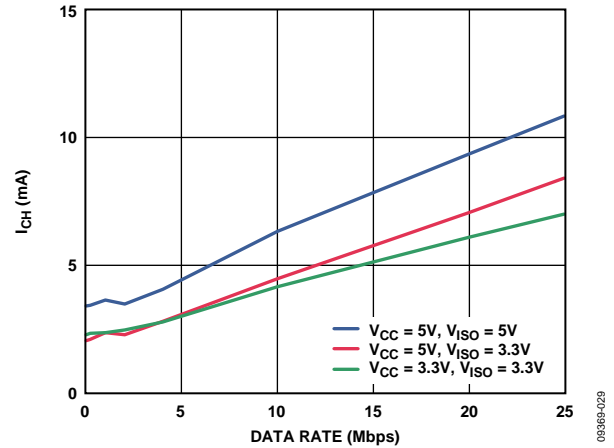

Figure 18. Typical Single-Supply  $I_{CH}$  Supply Current per Forward Data Channel (15 pF Output Load)

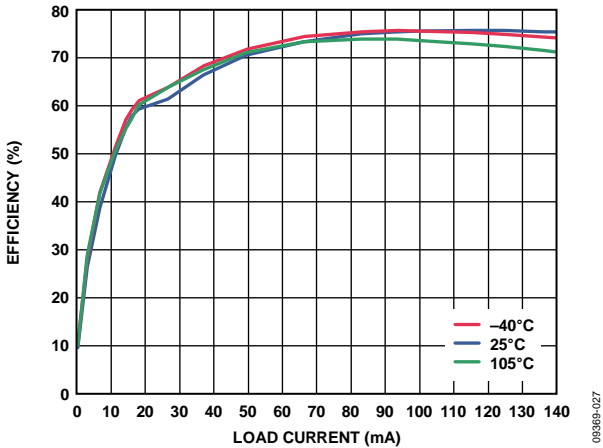

Figure 16. 5 V In to 15 V Out Efficiency over Temperature with Coilcraft Transformer at 500 kHz  $f_{SW}$

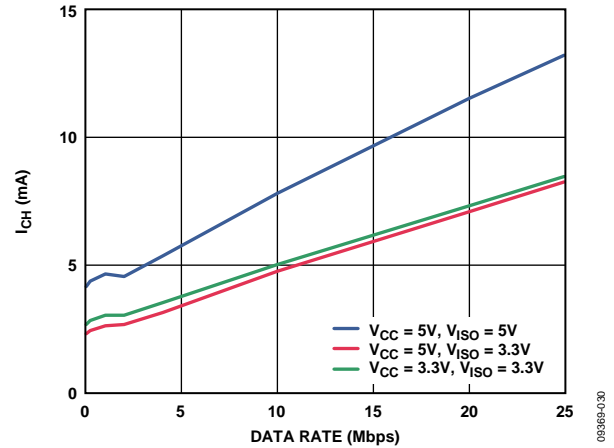

Figure 19. Typical Single-Supply  $I_{CH}$  Supply Current per Reverse Data Channel (15 pF Output Load)

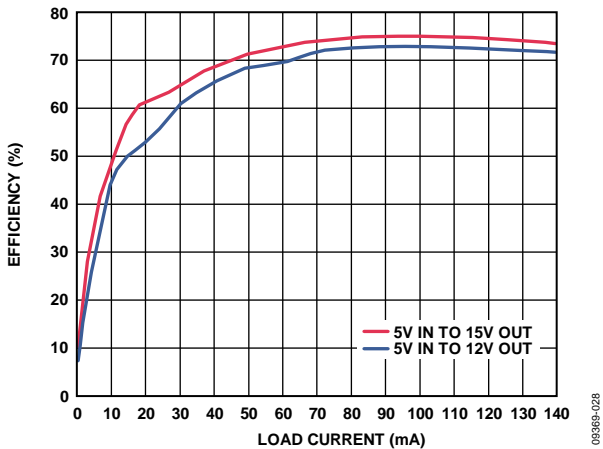

Figure 17. Double-Supply Efficiency with Coilcraft Transformer at 500 kHz  $f_{SW}$

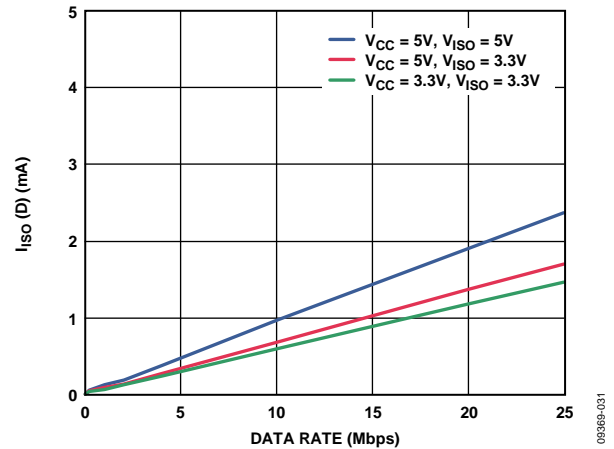

Figure 20. Typical Single-Supply  $I_{ISO(D)}$  Dynamic Supply Current per Output Channel (15 pF Output Load)

# ADuM3470/ADuM3471/ADuM3472/ADuM3473/ADuM3474

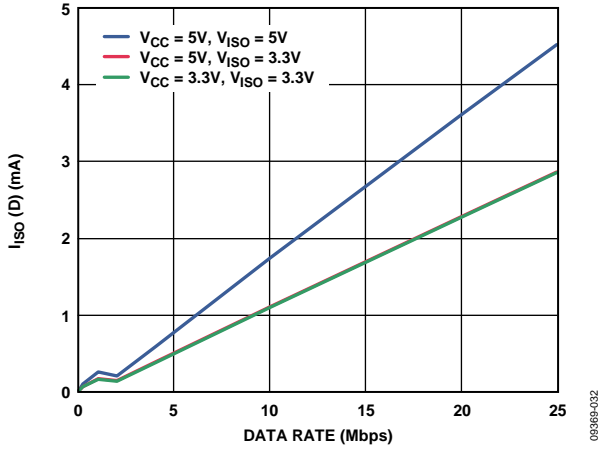

Figure 21. Typical Single Supply  $I_{ISO(D)}$  Dynamic Supply Current per Input Channel

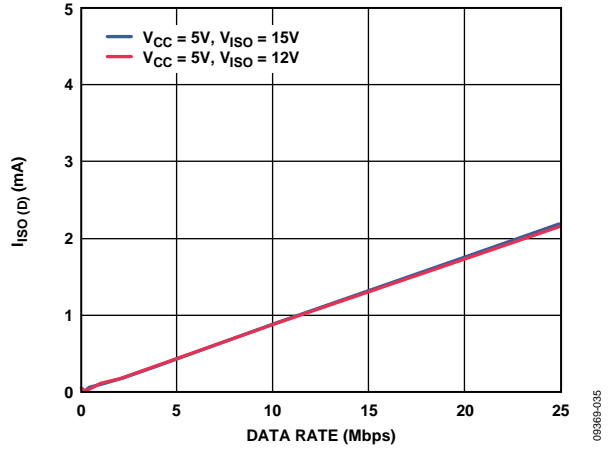

Figure 24. Typical Double Supply  $I_{ISO(D)}$  Dynamic Supply Current per Output Channel (15 pF Output Load)

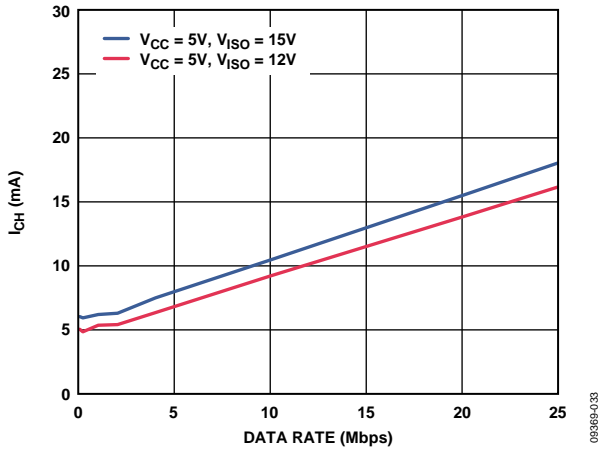

Figure 22. Typical Double Supply  $I_{CH}$  Supply Current per Forward Data Channel (15 pF Output Load)

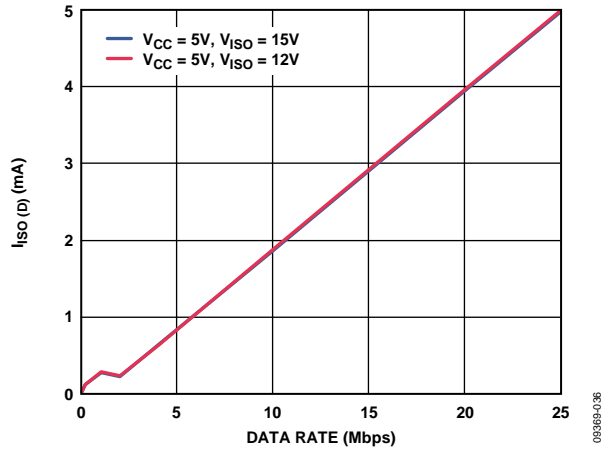

Figure 25. Typical Double Supply  $I_{ISO(D)}$  Dynamic Supply Current per Input Channel

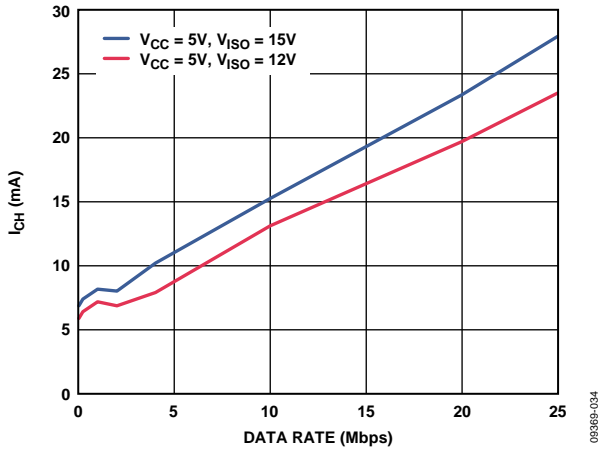

Figure 23. Typical Double Supply  $I_{CH}$  Supply Current per Reverse Data Channel (15 pF Output Load)

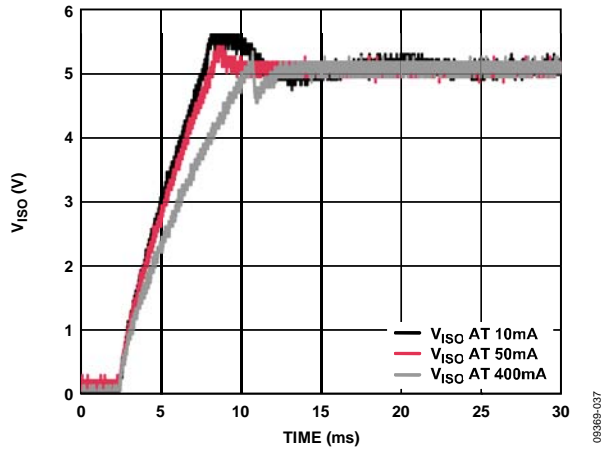

Figure 26. Typical  $V_{ISO}$  Startup 5V In to 5V Out with 10 mA, 50 mA, and 400 mA Output Load

# ADuM3470/ADuM3471/ADuM3472/ADuM3473/ADuM3474

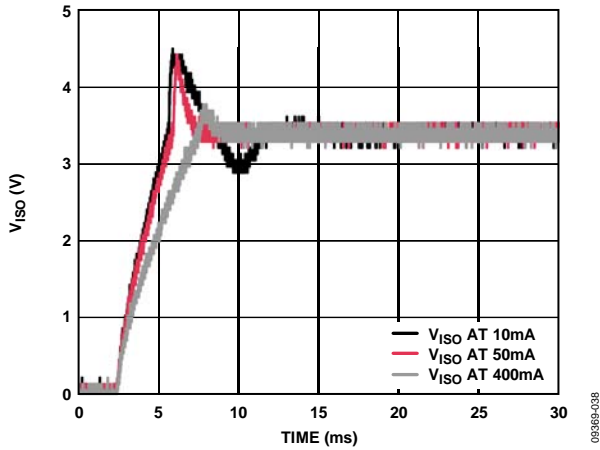

Figure 27. Typical  $V_{ISO}$  Startup 5 V In to 3.3 V Out with 10 mA, 50 mA, and 400 mA Output Load

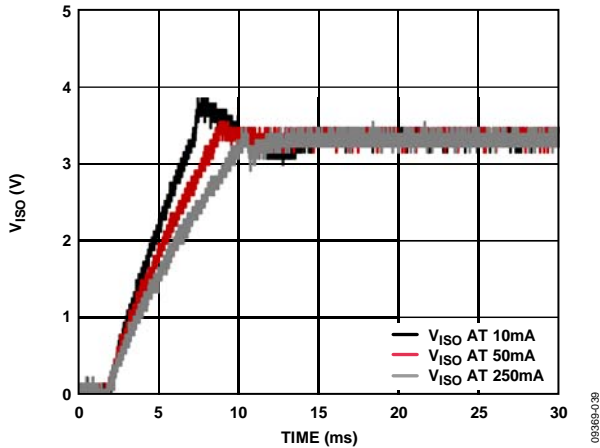

Figure 28. Typical  $V_{ISO}$  Startup 3.3 V In to 3.3 V Out with 10 mA, 50 mA, and 250 mA Output Load

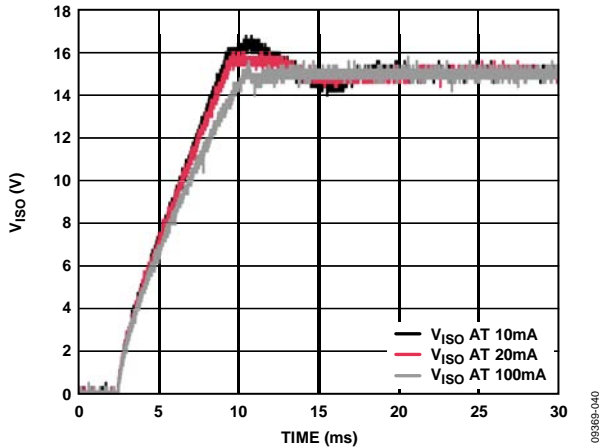

Figure 29. Typical  $V_{ISO}$  Startup 5 V In to 15 V Out with 10 mA, 20 mA, and 100 mA Output Load

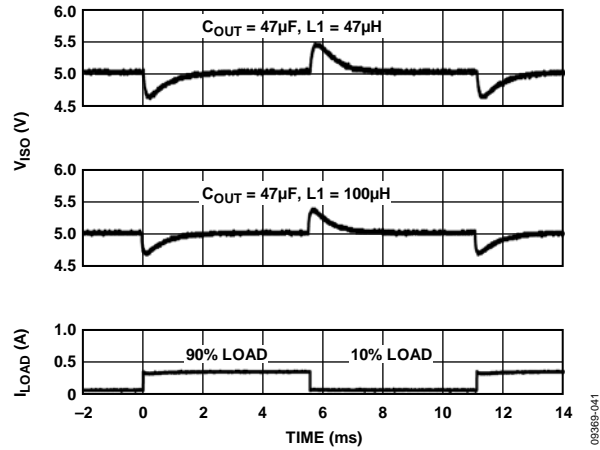

Figure 30. Typical  $V_{ISO}$  Load Transient Response 5 V In to 5 V Out at 10% to 90% of 400 mA Load at 500 kHz  $f_{SW}$

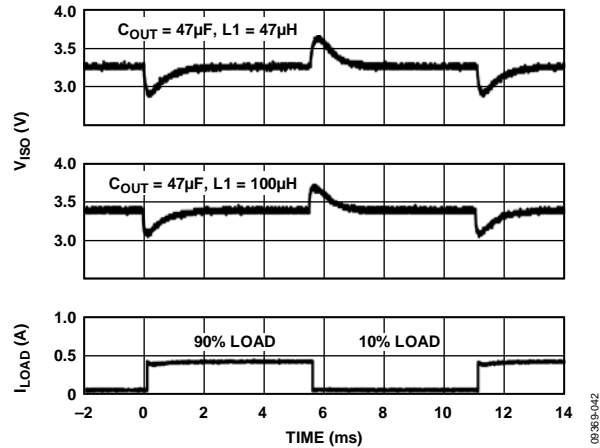

Figure 31. Typical  $V_{ISO}$  Load Transient Load Response 5 V In to 3.3 V Out at 10% to 90% Load of 400 mA Load at 500 kHz  $f_{SW}$

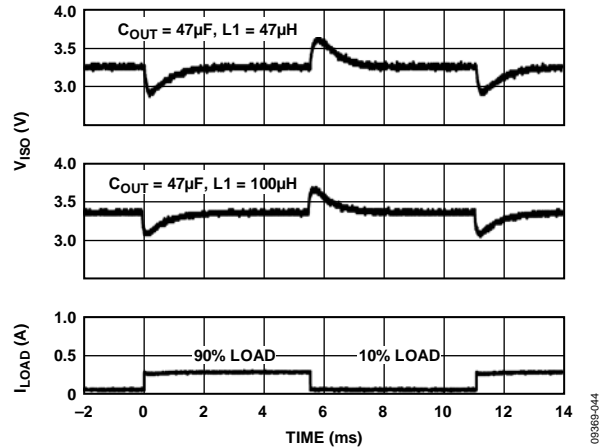

Figure 32. Typical  $V_{ISO}$  Load Transient Response 3.3 V In to 3.3 V Out at 10% to 90% of 250 mA Load at 500 kHz  $f_{SW}$

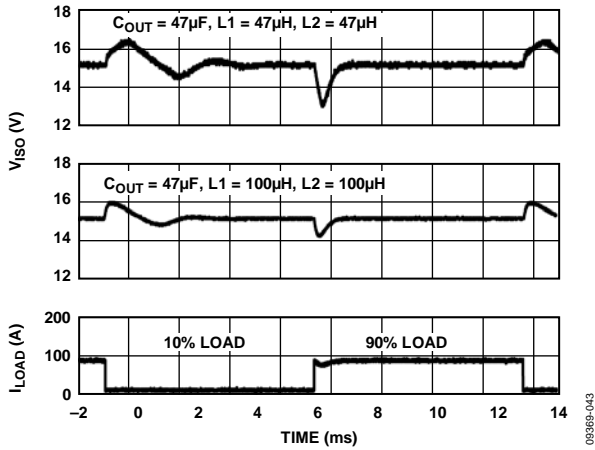

Figure 33. Typical  $V_{ISO}$  Load Transient Response 5 V In to 15 V Out at 10% to 90% of 100 mA Load at 500 kHz  $f_{sw}$

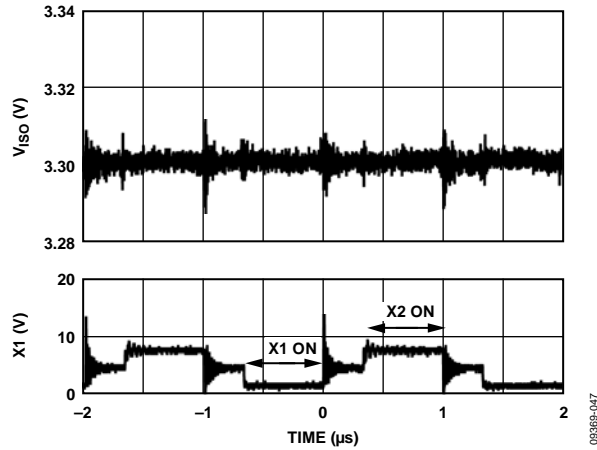

Figure 36. Typical  $V_{ISO}$  Output Ripple 3.3 V In to 3.3 V Out at 250 mA Load at 500 kHz  $f_{sw}$

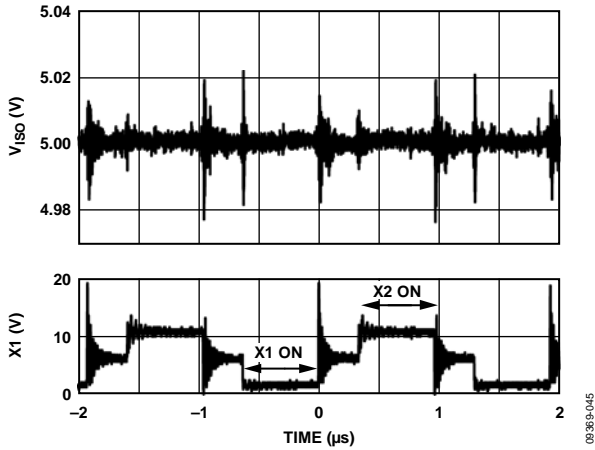

Figure 34. Typical  $V_{ISO}$  Output Ripple 5 V In to 5 V Out at 400 mA Load at 500 kHz  $f_{sw}$

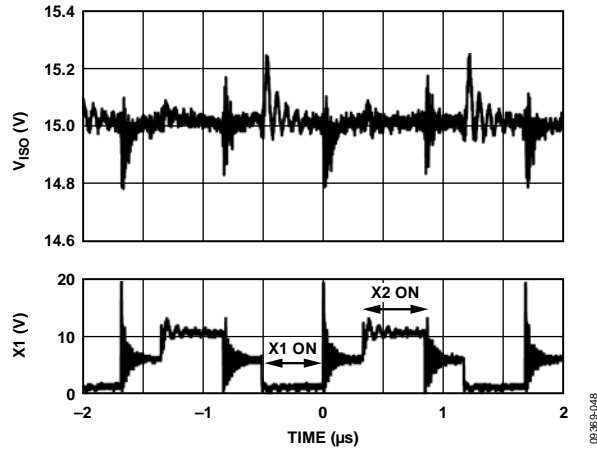

Figure 37. Typical  $V_{ISO}$  Output Ripple 5 V In to 15 V Out at 100 mA Load at 500 kHz  $f_{sw}$

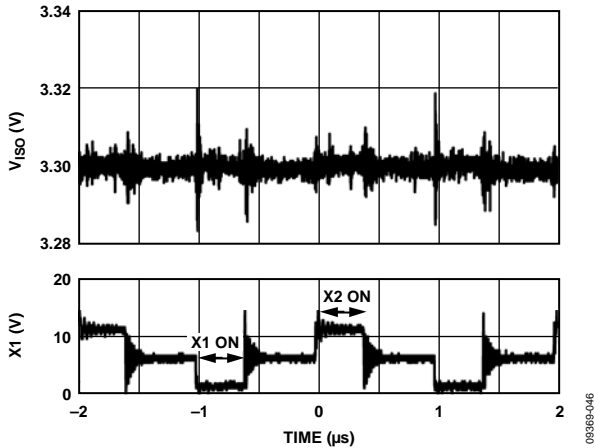

Figure 35. Typical  $V_{ISO}$  Output Ripple 5 V In to 3.3 V Out at 400 mA Load at 500 kHz  $f_{sw}$

## TERMINOLOGY

### $I_{CC(Q)}$

$I_{CC(Q)}$  is the minimum operating current drawn at the  $V_{CC}$  power input when there is no external load at  $V_{ISO}$  and the I/O pins are operating below 2 Mbps, requiring no additional dynamic supply current.

### $I_{CC(D)}$

$I_{CC(D)}$  is the typical input supply current with all channels simultaneously driven at a maximum data rate of 25 Mbps with the full capacitive load representing the maximum dynamic load conditions. Treat resistive loads on the outputs separately from the dynamic load.

### $I_{CC(MAX)}$

$I_{CC(MAX)}$  is the input current under full dynamic and  $V_{ISO}$  load conditions.

### $t_{PHL}$ Propagation Delay

$t_{PHL}$  propagation delay is measured from the 50% level of the falling edge of the  $V_{IX}$  signal to the 50% level of the falling edge of the  $V_{OX}$  signal.

### $t_{PLH}$ Propagation Delay

$t_{PLH}$  propagation delay is measured from the 50% level of the rising edge of the  $V_{IX}$  signal to the 50% level of the rising edge of the  $V_{OX}$  signal.

### Propagation Delay Skew ( $t_{PSK}$ )

$t_{PSK}$  is the magnitude of the worst-case difference in  $t_{PHL}$  and/or  $t_{PLH}$  that is measured between units at the same operating temperature, supply voltages, and output load within the recommended operating conditions.

### Channel-to-Channel Matching

Channel-to-channel matching is the absolute value of the difference in propagation delays between the two channels when operated with identical loads.

### Minimum Pulse Width

The minimum pulse width is the shortest pulse width at which the specified pulse width distortion is guaranteed.

### Maximum Data Rate

The maximum data rate is the fastest data rate at which the specified pulse width distortion is guaranteed.



## APPLICATIONS INFORMATION

### THEORY OF OPERATION

The dc-to-dc converter section of the ADuM347x uses a secondary side controller architecture with isolated pulse-width modulation (PWM) feedback.  $V_{CC}$  power is supplied to an oscillating circuit that switches current to the primary of an external power transformer using internal push-pull switches at the X1 and X2 pins. Power transferred to the secondary side of the transformer is full-wave rectified with external Schottky diodes (D1 and D2), filtered with the L1 inductor and  $C_{OUT}$  capacitor, and regulated to the isolated power supply voltage from 3.3 V to 15 V. The secondary ( $V_{ISO}$ ) side controller regulates the output by using a feedback voltage  $V_{FB}$  from a resistor divider on the output and creating a PWM control signal that is sent to the primary ( $V_{CC}$ ) side by a dedicated iCoupler data channel labeled  $V_{FB}$ . The primary side PWM converter varies the duty cycle of the X1 and X2 switches to modulate the oscillator circuit and control the power being sent to the secondary side. This feedback allows for significantly higher power and efficiency.

The ADuM347x implement undervoltage lockout (UVLO) with hysteresis on the  $V_{CC}$  power input. This feature ensures that the converter does not go into oscillation due to noisy input power or slow power-on ramp rates.

A minimum load current of 10 mA is recommended to ensure optimum load regulation. Smaller loads can generate excess noise on the output due to short or erratic PWM pulses. Excess noise generated this way can cause regulation problems, in some circumstances.

### APPLICATION SCHEMATICS

The ADuM347x has three main application schematics, as shown in Figure 38 to Figure 40. Figure 38 has a center-tapped secondary and two Schottky diodes providing full wave rectification for a single output, typically for power supplies of 3.3 V, 5 V, 12 V, and 15 V. For single supplies when  $V_{ISO} = 3.3$  V or  $V_{ISO} = 5$  V, see the note in Figure 38 about connecting together  $V_{REG}$ ,  $V_{DD2}$ , and  $V_{ISO}$ . Figure 39 is a voltage doubling circuit that can be used for a single supply whose output exceeds 15 V, which is the largest supply that can be connected to the regulator input  $V_{REG}$  (Pin 20) of the part. With Figure 39, the output voltage can be as high as 24 V and the  $V_{REG}$  pin only about 12 V. Figure 40, which also uses a voltage doubling secondary circuit, is shown as an example of a coarsely regulated, positive power supply and an unregulated, negative power supply, for outputs of approximately  $\pm 5$  V,  $\pm 12$  V, and  $\pm 15$  V. For any circuit in Figure 38, Figure 39, or Figure 40, the isolated output voltage ( $V_{ISO}$ ) can be set using the voltage dividers, R1 and R2 (values 1 k $\Omega$  to 100 k $\Omega$ ), in the application schematics using the following equation:

$$V_{ISO} = V_{FB} \times \frac{R1 + R2}{R2}$$

where  $V_{FB}$  is the internal feedback voltage, which is approximately 1.25 V.

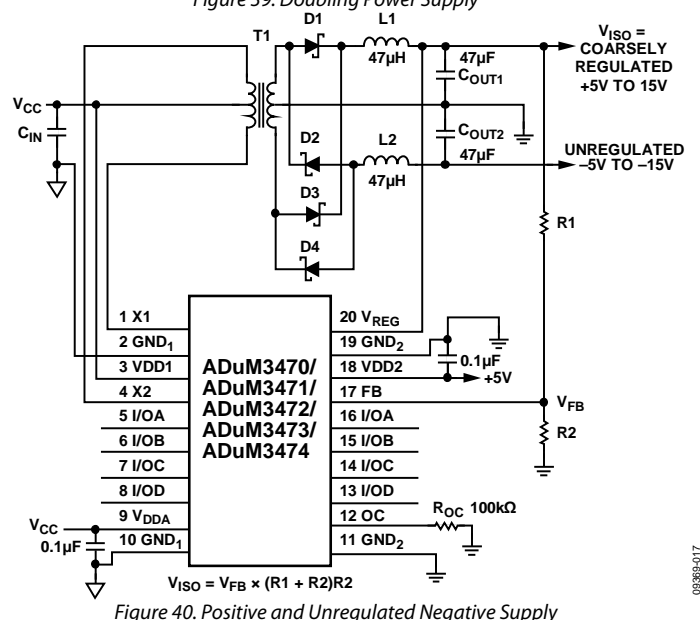
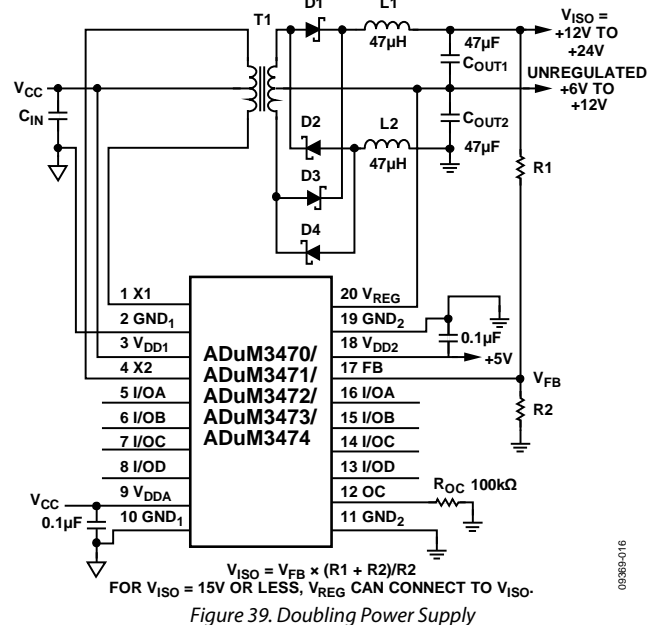
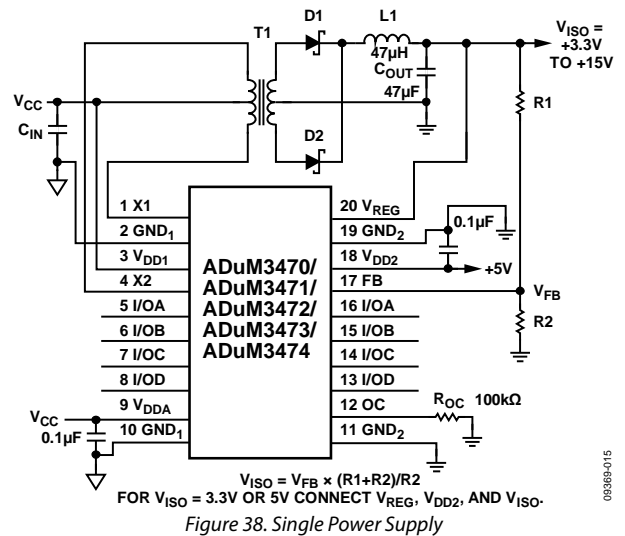

## TRANSFORMER DESIGN

Transformers have been designed for use in the circuits shown in Figure 38, Figure 39, and Figure 40 and are listed in Table 18. The design of a transformer for the ADuM347x can differ from some isolated dc-to-dc converter designs that do not regulate the output voltage. The output voltage is regulated by a PWM controller in the ADuM347x that varies the duty cycle of the primary side switches in response to a secondary side feedback voltage,  $V_{FB}$ , received through an isolated digital channel. The internal controller has a limit of 40% maximum duty cycle.

## TRANSFORMER TURNS RATIO

To determine the transformer turns ratio, and taking into account the losses for the primary switches and the losses for the secondary diodes and inductors, the external transformer turns ratio for the ADuM347x can be calculated by

$$\frac{N_S}{N_P} = \frac{V_{ISO} + V_D}{V_{CC(MIN)} \times D \times 2}$$

where:

$N_S/N_P$  is the primary to secondary turns ratio.

$V_{ISO}$  is the isolated output supply voltage.

$V_D$  is the Schottky diode voltage drop (0.5 V maximum).

$V_{CC(MIN)}$  is the minimum input supply voltage.

$D$  is the duty cycle = 0.30 for a 30% typical duty cycle, 40% is maximum, and a multiplier factor of 2 is used for the push-pull switching cycle.

For Figure 38, the 5 V to 5 V reference design in Table 18, with  $V_{CC(MIN)} = 4.5$  V, the turns ratio is  $N_S/N_P = 2$ .

For a similar 3.3 V to 3.3 V single power supply and with  $V_{CC(MIN)} = 3.0$  V, the turns ratio is also  $N_S/N_P = 2$ . Therefore, the same transformer turns ratio  $N_S/N_P = 2$  can be used for the three single power applications (5 V to 5 V, 5 V to 3.3 V, and 3.3 V to 3.3 V).

For Figure 39, the circuit uses double windings and diode pairs to create a doubler circuit; therefore, half the output voltage,  $V_{ISO}/2$ , is used in the equation.

$$\frac{N_S}{N_P} = \frac{\frac{V_{ISO}}{2} + V_D}{V_{CC(MIN)} \times D \times 2}$$

$N_S/N_P$  is the primary to secondary turns ratio.

$V_{ISO}/2$  is used in the equation because the circuit uses two pairs of diodes creating a doubler circuit.

$V_D$  is the Schottky diode voltage drop (0.5 V maximum).

$V_{CC(MIN)}$  is the minimum input supply voltage.

$D$  is duty cycle which equals 0.30 for a 30% typical duty cycle, 40% is maximum, and a multiplier factor of 2 is used for the push-pull switching cycle.

For Figure 39, the 5 V to 15 V reference design in Table 18, with  $V_{CC(MIN)} = 4.5$  V, the turns ratio is  $N_S/N_P = 3$ .

For Figure 40, the circuit also uses double windings and diode pairs to create a doubler circuit; however, because a positive and negative output voltage is created,  $V_{ISO}$  is used in the equation.

$$\frac{N_S}{N_P} = \frac{V_{ISO} + V_D}{V_{CC(MIN)} \times D \times 2}$$

where:

$N$  is the primary to secondary turns ratio.

$V_{ISO}$  is the isolated output supply voltage and is used in the equation because the circuit uses two pairs of diodes creating a doubler circuit with a positive and negative output.

$V_D$  is the Schottky diode voltage drop (0.5 V maximum).

$V_{CC(MIN)}$  is the minimum input supply voltage, and a multiplier factor of 2 is used for the push-pull switching cycle. A higher duty cycle of  $D = 0.35$  for a 35% typical duty cycle (40% is maximum) was used in the Figure 40 circuit to reduce the maximum voltages seen by the diodes for a  $\pm 15$  V supply.

For Figure 40, the +5 V to  $\pm 15$  V reference design in Table 18, with  $V_{CC(MIN)} = 4.5$  V, the turns ratio is  $N_S/N_P = 5$ .

## TRANSFORMER ET CONSTANT

The next transformer design factor to consider is the ET constant. This constant determines the minimum  $V \times \mu s$  constant of the transformer over the operating temperature. ET values of  $14 V \times \mu s$  and  $18 V \times \mu s$  were selected for the ADuM347x designs listed in Table 18 using the following equation:

$$ET(Min) = \frac{V_{CC(MAX)}}{f_{SW(MIN)} \times 2}$$

where:

$V_{CC(MAX)}$  is the maximum input supply voltage.

$f_{SW(MIN)}$  is the minimum primary switching frequency = 300 kHz in startup, and a multiplier factor of 2 is used for the push-pull switching cycle.

## TRANSFORMER PRIMARY INDUCTANCE AND RESISTANCE

Another important characteristic of the transformer for designs with the ADuM347x is the primary inductance. Transformers for the ADuM347x are recommended to have between 60  $\mu H$  to 100  $\mu H$  of inductance per primary winding. Values of primary inductance in this range are needed for smooth operation of the ADuM347x pulse-by-pulse current-limit circuit, which can help protect against build up of saturation currents in the transformer. If the inductance is specified for the total of both primary windings, for example, as 400  $\mu H$ , the inductance of one winding is  $\frac{1}{4}$  of two equal windings, or 100  $\mu H$ .

Another important characteristic of the transformer for designs with the ADuM347x is primary resistance. Primary resistance as low as is practical (less than 1  $\Omega$ ) helps reduce losses and improves efficiency. The dc primary resistance can be measured and specified, and is shown for the transformers in Table 18.

**Table 18. Transformer Reference Designs**

Part No.	Manufacturer	Turns Ratio, PRI:SEC	ET Constant (V × μs Min)	Total Primary Inductance (μH)	Total Primary Resistance (Ω)	Isolation Voltage (rms)	Isolation Type	Reference
JA4631-BL	Coilcraft	1CT:2CT	18	255	0.2	2500	Basic	Figure 38
JA4650-BL	Coilcraft	1CT:3CT	18	255	0.2	2500	Basic	Figure 39
KA4976-AL	Coilcraft	1CT:5CT	18	255	0.2	2500	Basic	Figure 40
TGSAD-260V6LF	Halo Electronics	1CT:2CT	14	389	0.8	2500	Supplemental	Figure 38
TGSAD-290V6LF	Halo Electronics	1CT:3CT	14	389	0.8	2500	Supplemental	Figure 39
TGSAD-292V6LF	Halo Electronics	1CT:5CT	14	389	0.8	2500	Supplemental	Figure 40
TGAD-260NARL	Halo Electronics	1CT:2CT	14	389	0.8	1500	Functional	Figure 38
TGAD-290NARL	Halo Electronics	1CT:3CT	14	389	0.8	1500	Functional	Figure 39
TGAD-292NARL	Halo Electronics	1CT:5CT	14	389	0.8	1500	Functional	Figure 40

## TRANSFORMER ISOLATION VOLTAGE

Isolation voltage and isolation type should be determined for the requirements of the application and then specified. The transformers in Table 18 have been specified for 2500 V rms for supplemental or basic isolation and for 1500 V rms functional isolation. Other isolation levels and isolation voltages can be specified and requested from the manufacturers in Table 18 or from other manufacturers.

## SWITCHING FREQUENCY

The ADuM347x switching frequency can be adjusted from 200 kHz to 1 MHz by changing the value of the R<sub>OC</sub> resistor shown in Figure 38, Figure 39, and Figure 40. The value of the R<sub>OC</sub> resistor needed for the desired switching frequency can be determined from the switching frequency vs. R<sub>OC</sub> resistance curve shown in Figure 9. The output filter inductor value and output capacitor value for the ADuM347x application schematics have been designed to be stable over the switching frequency range from 500 kHz to 1 MHz, when loaded from 10% to 90% of the maximum load.

The ADuM347x also has an open-loop mode where the output voltage is not regulated and is dependent on the transformer turns ratio, N<sub>S</sub>/N<sub>P</sub>, and the conditions of the output including output load current and the losses in the dc-to-dc converter circuit. This open-loop mode is selected when the OC pin is connected high to the V<sub>DD2</sub> pin. In open-loop mode, the switching frequency is 318 kHz.

## TRANSIENT RESPONSE

The load transient response of the output voltage of the ADuM347x for 10% to 90% of the full load is shown in Figure 30 to Figure 33 for the application schematics in Figure 38 and Figure 39. The response shown is slow but stable and can have more output change than desired for some applications. The output voltage change with load transient has been reduced, and the output has been shown to remain stable by adding more inductance to the output circuits, as shown in the second V<sub>ISO</sub> output waveform in Figure 30 to Figure 33.

## COMPONENT SELECTION

The ADuM347x digital isolators with 2 W dc-to-dc converters require no external interface circuitry for the logic interfaces. Power supply bypassing is required at the input and output supply pins. Note that a low ESR ceramic bypass capacitor of 0.1 μF is required on Side 1 between Pin 9 and Pin 10, and on Side 2 between Pin 18 and Pin 19, as close to the chip pads as possible.

The power supply section of the ADuM347x uses a high oscillator frequency to efficiently pass power through the external power transformer. In addition, normal operation of the data section of the iCoupler introduces switching transients on the power supply pins. Bypass capacitors are required for several operating frequencies. Noise suppression requires a low inductance, high frequency capacitor; ripple suppression and proper regulation require a large value capacitor. To suppress noise and reduce ripple, large-valued ceramic capacitors of X5R or X7R dielectric type are recommended. The recommended capacitor value is 10 μF for V<sub>DD1</sub> and 47 μF for V<sub>ISO</sub>. These capacitors have a low ESR and are available in moderate 1206 or 1210 sizes for voltages up to 10 V. For output voltages larger than 10 V, two 22 μF ceramic capacitors can be used in parallel. See Table 19 for recommended components.

# ADuM3470/ADuM3471/ADuM3472/ADuM3473/ADuM3474

Inductors must be selected based on the value and supply current needed. Most applications with switching frequencies between 500 kHz and 1 MHz and load transients between 10% and 90% of full load are stable with the 47  $\mu\text{H}$  inductor value listed in Table 19. Values as large as 200  $\mu\text{H}$  can be used for power supply applications with a switching frequency as low as 200 kHz to help stabilize the output voltage or for improved load transient response (see Figure 30 to Figure 33). Inductors in a small 1212 or 1210 size are listed in Table 19 with a 47  $\mu\text{H}$  value and a 0.41 A current rating to handle the majority of applications below a 400 mA load, and with a 100  $\mu\text{H}$  value and a 0.34 A current rating to handle a load to 300 mA.

Schottky diodes are recommended for their low forward voltage to reduce losses and their high reverse voltage of up to 40 V to withstand the peak voltages available in the doubling circuit shown in Figure 39 and Figure 40.

**Table 19. Recommended Components**

Part Number	Manufacturer	Value
GRM32ER71A476KE15L	Murata	47 $\mu\text{F}$ , 10 V, X7R, 1210
GRM32ER71C226KEA8L	Murata	22 $\mu\text{F}$ , 16 V, X7R, 1210
GRM31CR71A106KA01L	Murata	10 $\mu\text{F}$ , 10 V, X7R, 1206
MBR0540T1-D	ON Semiconductor	0.5 A, 40 V, Schottky, SOD-123
LQH3NPN470MM0	Murata	47 $\mu\text{H}$ , 0.41 A, 1212
ME3220-104KL	Coilcraft	100 $\mu\text{H}$ , 0.34 A, 1210

## PRINTED CIRCUIT BOARD (PCB) LAYOUT

Note that the total lead length between the ends of the low ESR capacitor and the  $V_{\text{DDx}}$  and  $\text{GND}_x$  pins must not exceed 2 mm. Installing the bypass capacitor with traces more than 2 mm in length can result in data corruption. See Figure 41 for the recommended PCB layout.

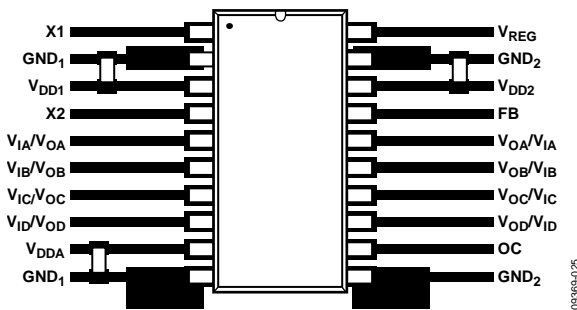

Figure 41. Recommended PCB Layout

In applications involving high common-mode transients, take care to ensure that board coupling across the isolation barrier is minimized. Furthermore, design the board layout such that any coupling that does occur equally affects all pins on a given component side. Failure to ensure this can cause voltage differentials between pins, exceeding the absolute maximum ratings specified in Table 10, thereby leading to latch-up and/or permanent damage.

The ADuM347x are power devices that dissipate about 1 W of power when fully loaded and running at maximum speed. Because it is not possible to apply a heat sink to an isolation device, the devices primarily depend on heat dissipation into the PCB through the  $\text{GND}_x$  pins. If the devices are used at high ambient temperatures, care must be taken to provide a thermal path from the  $\text{GND}_x$  pins to the PCB ground plane. The board layout shows enlarged pads for the  $\text{GND}_x$  pins (Pin 2 and Pin 10) on Side 1 and (Pin 11 and Pin 19) on Side 2. Large diameter vias should be implemented from the pad to the ground planes and power planes to increase thermal conductivity and to reduce inductance. Multiple vias in the thermal pads can significantly reduce temperatures inside the chip. The dimensions of the expanded pads are left to the discretion of the designer and the available board space.

## THERMAL ANALYSIS

The ADuM347x parts consist of two internal die attached to a split lead frame with two die attach paddles. For the purposes of thermal analysis, the die are treated as a thermal unit, with the highest junction temperature reflected in the  $\theta_{\text{JA}}$  from Table 5. The value of  $\theta_{\text{JA}}$  is based on measurements taken with the parts mounted on a JEDEC standard, 4-layer board with fine width traces and still air. Under normal operating conditions, the ADuM347x devices operate at full load across the full temperature range without derating the output current. However, following the recommendations in the Printed Circuit Board (PCB) Layout section decreases thermal resistance to the PCB, allowing increased thermal margins in high ambient temperatures. The ADuM347x has an thermal shutdown circuit that shuts down the dc-to-dc converter and the outputs of the ADuM347x when a die temperature of about 160°C is reached. When the die cools below about 140°C, the ADuM347x dc-to-dc converter and outputs turn on again.

## PROPAGATION DELAY-RELATED PARAMETERS

Propagation delay is a parameter that describes the time it takes a logic signal to propagate through a component (see Figure 42). The propagation delay to a logic low output may differ from the propagation delay to a logic high output.

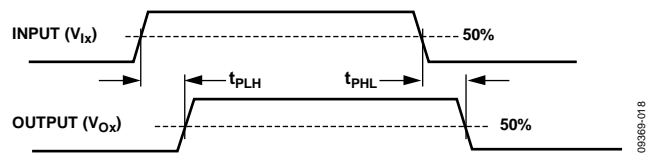

Figure 42. Propagation Delay Parameters

Pulse width distortion is the maximum difference between these two propagation delay values and is an indication of how accurately the input signal timing is preserved.

Channel-to-channel matching refers to the maximum amount the propagation delay differs between channels within a single ADuM347x component.

Propagation delay skew refers to the maximum amount the propagation delay differs between multiple ADuM347x components operating under the same conditions.

## DC CORRECTNESS AND MAGNETIC FIELD IMMUNITY

Positive and negative logic transitions at the isolator input cause narrow (~1 ns) pulses to be sent to the decoder via the transformer. The decoder is bistable and is, therefore, either set or reset by the pulses, indicating input logic transitions. In the absence of logic transitions at the input for more than 1 μs, periodic sets of refresh pulses indicative of the correct input state are sent to ensure dc correctness at the output. If the decoder receives no internal pulses of more than approximately 5 μs, the input side is assumed to be unpowered or nonfunctional, in which case the isolator output is forced to a default state (see Table 17) by the watchdog timer circuit. This situation should occur in the ADuM347x devices only during power-up and power-down operations.

The limitation on the ADuM347x magnetic field immunity is set by the condition in which induced voltage in the transformer receiving coil is sufficiently large to either falsely set or reset the decoder. The following analysis defines the conditions under which this can occur.

The 3.3 V operating condition of the ADuM347x is examined because it represents the most susceptible mode of operation.

The pulses at the transformer output have an amplitude of >1.0 V. The decoder has a sensing threshold of about 0.5 V, thus establishing a 0.5 V margin in which induced voltages can be tolerated. The voltage induced across the receiving coil is given by

$$V = (-d\beta/dt)\sum\pi r_n^2; n = 1, 2, \dots, N$$

where:

$\beta$  is magnetic flux density (gauss).

$N$  is the number of turns in the receiving coil.

$r_n$  is the radius of the  $n^{\text{th}}$  turn in the receiving coil (cm).

Given the geometry of the receiving coil in the ADuM347x and an imposed requirement that the induced voltage be, at most, 50% of the 0.5 V margin at the decoder, a maximum allowable magnetic field is calculated as shown in Figure 43.

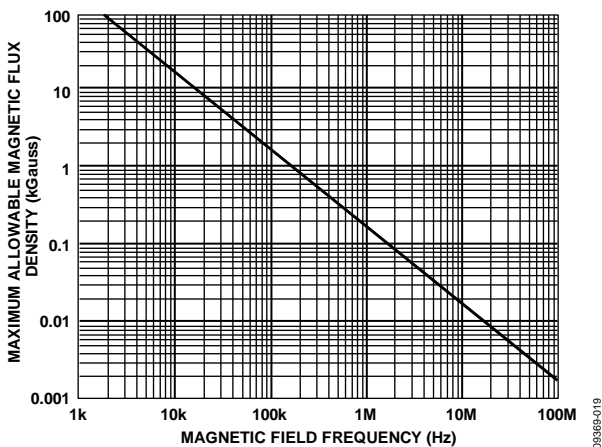

Figure 43. Maximum Allowable External Magnetic Flux Density

For example, at a magnetic field frequency of 1 MHz, the maximum allowable magnetic field of 0.2 kGauss induces a voltage of 0.25 V at the receiving coil. This is about 50% of the sensing threshold and does not cause a faulty output transition. Similarly, if such an event occurs during a transmitted pulse (and is of the worst-case polarity), it reduces the received pulse from >1.0 V to 0.75 V, which is still well above the 0.5 V sensing threshold of the decoder.

The preceding magnetic flux density values correspond to specific current magnitudes at given distances from the ADuM347x transformers. Figure 44 expresses these allowable current magnitudes as a function of frequency for selected distances. As shown in Figure 44, the ADuM347x are extremely immune and can be affected only by extremely large currents operated at high frequency very close to the component. For the 1 MHz example, a 0.5 kA current needs to be placed 5 mm away from the ADuM347x to affect component operation.

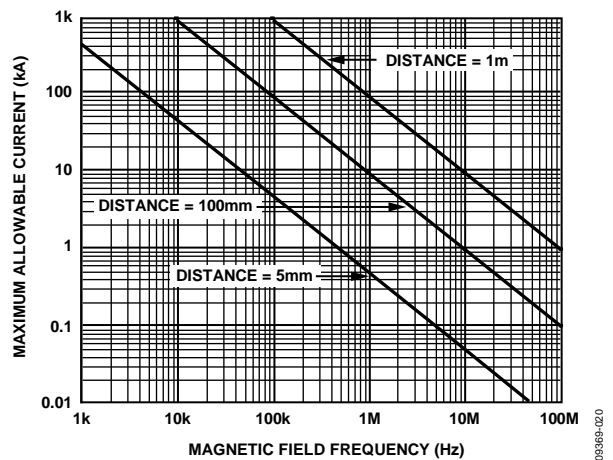

Figure 44. Maximum Allowable Current for Various Current-to-ADuM347x Spacings

In combinations of strong magnetic field and high frequency, any loops formed by PCB traces can induce error voltages sufficiently large to trigger the thresholds of succeeding circuitry. Care should be taken in the layout of such traces to avoid this possibility.



## POWER CONSUMPTION

The  $V_{CC}$  power supply input provides power to the *iCoupler* data channels, as well as to the power converter. For this reason, the quiescent currents drawn by the data converter and the primary and secondary I/O channels cannot be determined separately. All of these quiescent power demands have been combined into the  $I_{CC(Q)}$  current, as shown in Figure 45. The total  $I_{CC}$  supply current is equal to the sum of the quiescent operating current; the dynamic current,  $I_{CC(D)}$ , demanded by the I/O channels; and any external  $I_{ISO}$  load.

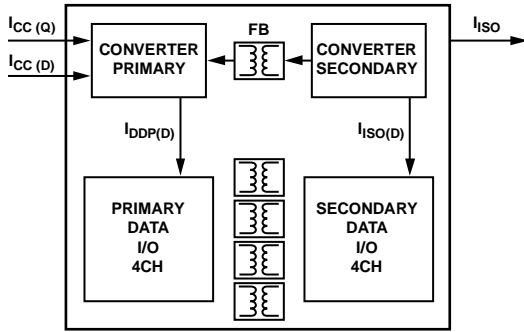

Figure 45. Power Consumption Within the ADuM347x

Dynamic I/O current is consumed only when operating a channel at speeds higher than the refresh rate of  $f_r$ . The dynamic current of each channel is determined by its data rate. Figure 18 and Figure 22 show the current for a channel in the forward direction, meaning that the input is on the  $V_{CC}$  side of the part. Figure 19 and Figure 23 show the current for a channel in the reverse direction, meaning that the input is on the  $V_{ISO}$  side of the part. Figure 18, Figure 19, Figure 22, and Figure 23 assume a typical 15 pF output load.

The following relationship allows the total  $I_{DD1}$  current to be

$$I_{CC} = (I_{ISO} \times V_{ISO}) / (E \times V_{CC}) + \sum I_{CHn}; n = 1 \text{ to } 4 \quad (1)$$

where:

$I_{CC}$  is the total supply input current.

$I_{ISO}$  is the current drawn by the secondary side external load.

$E$  is the power supply efficiency at the given output load from Figure 13 or Figure 17 at the  $V_{ISO}$  and  $V_{CC}$  condition of interest.

$I_{CHn}$  is the current drawn by a single channel determined from Figure 18, Figure 19, Figure 22, or Figure 23, depending on channel direction.

The maximum external load can be calculated by subtracting the dynamic output load from the maximum allowable load.

$$I_{ISO(Load)} = I_{ISO(MAX)} - \sum I_{ISO(D)n}; n = 1 \text{ to } 4 \quad (2)$$

where:

$I_{ISO(Load)}$  is the current available to supply an external secondary side load.

$I_{ISO(MAX)}$  is the maximum external secondary side load current available at  $V_{ISO}$ .

$I_{ISO(D)n}$  is the dynamic load current drawn from  $V_{ISO}$  by an output or input channel, as shown for a single supply in Figure 20 or Figure 21 or for a double supply in Figure 24 or Figure 25.

The preceding analysis assumes a 15 pF capacitive load on each data output. If the capacitive load is larger than 15 pF, the additional current must be included in the analysis of  $I_{DD1}$  and  $I_{ISO(Load)}$ .

## POWER CONSIDERATIONS

### Soft Start Mode and Current-Limit Protection

When the ADuM347x first receives power from  $V_{CC}$ , it is in soft start mode, and the output voltage  $V_{ISO}$  is increased gradually while it is below the startup threshold. In soft start mode, the width of the PWM signal is increased gradually by the primary converter to limit the peak current during  $V_{ISO}$  power-up. When the output voltage is larger than the startup threshold, the PWM signal can be transferred from the secondary controller to the primary converter, and the dc-to-dc converter switches from soft start mode to the normal PWM control mode. If a short circuit occurs, the push-pull converter shuts down for about 2 ms and then enters soft start mode. If, at the end of soft start, a short circuit still exists, the process is repeated, which is called hiccup mode. If the short circuit is cleared, the ADuM347x enters normal operation.

The ADuM347x also has a pulse-by-pulse current limit, which is active in startup and normal operation, and protects the primary switches, X1 and X2, from exceeding approximately 1.2 A peak and also protects the transformer windings.

### Data Channel Power Cycle

The ADuM347x data input channels on the primary side and the data input channels on the secondary side are protected from premature operation by UVLO circuitry. Below the minimum operating voltage, the power converter holds its oscillator inactive, and all input channel drivers and refresh circuits are idle. Outputs are held in a low state. This is to prevent transmission of undefined states during power-up and power-down operations.

During application of power to  $V_{CC}$ , the primary side circuitry is held idle until the UVLO preset voltage is reached. At that time, the data channels are initialized to their default low output state until they receive data pulses from the secondary side.

The primary side input channels sample the input and send a pulse to the inactive secondary output. The secondary side converter begins to accept power from the primary, and the  $V_{ISO}$  voltage starts to rise. When the secondary side UVLO is reached, the secondary side outputs are initialized to their default low state until data, either a transition or a dc refresh pulse, is received from the corresponding primary side input. It can take up to 1  $\mu$ s after the secondary side is initialized for the state of the output to correlate with the primary side input.

Secondary side inputs sample their state and transmit it to the primary side. Outputs are valid one propagation delay after the secondary side becomes active.

Because the rate of charge of the secondary side is dependent on the soft start cycle, loading conditions, input voltage, and output voltage level selected, care should be taken in the design to allow the converter to stabilize before valid data is required.

When power is removed from  $V_{CC}$ , the primary side converter and coupler shut down when the UVLO level is reached. The secondary side stops receiving power and starts to discharge. The outputs on the secondary side hold the last state that they received from the primary until either the UVLO level is reached, and the outputs are placed in their default low state, or the outputs detect a lack of activity from the inputs, and the outputs are set to their default value before the secondary power reaches UVLO.

## INSULATION LIFETIME

All insulation structures eventually break down when subjected to voltage stress over a sufficiently long period. The rate of insulation degradation is dependent on the characteristics of the voltage waveform applied across the insulation. Analog Devices conducts an extensive set of evaluations to determine the lifetime of the insulation structure within the ADuM347x. Accelerated life testing is performed using voltage levels higher than the rated continuous working voltage. Acceleration factors for several operating conditions are determined, allowing calculation of the time to failure at the working voltage of interest. The values shown in Table 11 summarize the peak voltages for 50 years of service life in several operating conditions. In many cases, the working voltage approved by agency testing is higher than the 50-year service life voltage. Operation at working voltages higher than the service life voltage listed leads to premature insulation failure.

The insulation lifetime of the ADuM347x depends on the voltage waveform type imposed across the isolation barrier. The iCoupler insulation structure degrades at different rates, depending on whether the waveform is bipolar ac, dc, or unipolar ac. Figure 46, Figure 47, and Figure 48 illustrate these different isolation voltage waveforms.

Bipolar ac voltage is the most stringent environment. A 50-year operating lifetime under the bipolar ac condition determines the Analog Devices recommended maximum working voltage.

In the case of unipolar ac or dc voltage, the stress on the insulation is significantly lower. This allows operation at higher working voltages while still achieving a 50-year service life. The working voltages listed in Table 11 can be applied while maintaining the 50-year minimum lifetime, provided that the voltage conforms to either the unipolar ac or dc voltage cases. Treat any cross-insulation voltage waveform that does not conform to Figure 47 or Figure 48 as a bipolar ac waveform, and limit its peak voltage to the 50-year lifetime voltage value listed in Table 11.

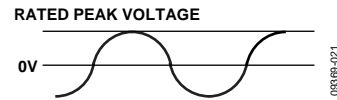

Figure 46. Bipolar AC Waveform

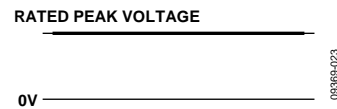
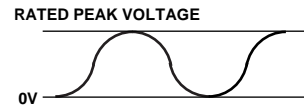

Figure 47. DC Waveform



**NOTES:**  
 1. THE VOLTAGE IS SHOWN SINUSOIDAL FOR ILLUSTRATION PURPOSES ONLY. IT IS MEANT TO REPRESENT ANY VOLTAGE WAVEFORM VARYING BETWEEN 0 AND SOME LIMITING VALUE. THE LIMITING VALUE CAN BE POSITIVE OR NEGATIVE, BUT THE VOLTAGE CANNOT CROSS 0V.

Figure 48. Unipolar AC Waveform

# ADuM3470/ADuM3471/ADuM3472/ADuM3473/ADuM3474

## OUTLINE DIMENSIONS

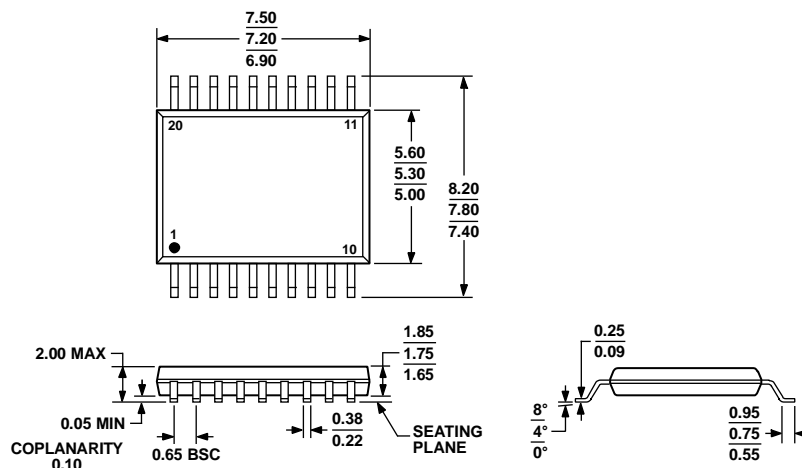

COMPLIANT TO JEDEC STANDARDS MO-150-AE

Figure 49. 20-Lead Shrink Small Outline Package [SSOP] (RS-20)

Dimensions shown in millimeters

060106-A

## ORDERING GUIDE

Model <sup>1, 2</sup>	Number of Inputs, V <sub>CC</sub> Side	Number of Inputs, V <sub>ISO</sub> Side	Maximum Data Rate (Mbps)	Maximum Propagation Delay, 5 V (ns)	Maximum Pulse Width Distortion (ns)	Temperature Range (°C)	Package Description	Package Option
ADuM3470ARSZ	4	0	1	100	40	-40 to +105	20-Lead SSOP	RS-20
ADuM3470CRSZ	4	0	25	60	6	-40 to +105	20-Lead SSOP	RS-20
ADuM3471ARSZ	3	1	1	100	40	-40 to +105	20-Lead SSOP	RS-20
ADuM3471CRSZ	3	1	25	60	6	-40 to +105	20-Lead SSOP	RS-20
ADuM3472ARSZ	2	2	1	100	40	-40 to +105	20-Lead SSOP	RS-20
ADuM3472CRSZ	2	2	25	60	6	-40 to +105	20-Lead SSOP	RS-20
ADuM3473ARSZ	1	3	1	100	40	-40 to +105	20-Lead SSOP	RS-20
ADuM3473CRSZ	1	3	25	60	6	-40 to +105	20-Lead SSOP	RS-20
ADuM3474ARSZ	0	4	1	100	40	-40 to +105	20-Lead SSOP	RS-20
ADuM3474CRSZ	0	4	25	60	6	-40 to +105	20-Lead SSOP	RS-20

<sup>1</sup> Tape and reel are available. The addition of an RL7 suffix designates a 7" (500 units) tape and reel option.

<sup>2</sup> Z = RoHS Compliant Part.