

FEATURES

- Broadband upconverter/downconverter**
- Power conversion gain of 1.8 dB**
- Broadband RF, LO, and IF ports**
- SSB noise figure (NF) of 9.75 dB**
- Input IP₃: 28.5 dBm**
- Input P_{1dB}: 13.3 dBm**
- Typical LO drive: 0 dBm**
- Single-supply operation: 5 V at 130 mA**
- Adjustable bias for low power operation**
- Exposed paddle, 4 mm × 4 mm, 24-lead LFCSP package**

APPLICATIONS

- Cellular base station receivers**
- Radio link downconverters**
- Broadband block conversion**
- Instrumentation**

GENERAL DESCRIPTION

The **ADL5801** uses a high linearity, doubly balanced, active mixer core with integrated LO buffer amplifier to provide high dynamic range frequency conversion from 10 MHz to 6 GHz. The mixer benefits from a proprietary linearization architecture that provides enhanced input IP₃ performance when subject to high input levels. A bias adjust feature allows the input linearity, SSB noise figure, and dc current to be optimized using a single control pin. An optional input power detector is provided for adaptive bias control. The high input linearity allows the device to be used in demanding cellular applications where in-band blocking signals may otherwise result in degradation in dynamic performance. The adaptive bias feature allows the part to provide high input IP₃ performance when presented with large blocking signals. When blockers are removed, the **ADL5801** can automatically bias down to provide low noise figure and low power consumption.

FUNCTIONAL BLOCK DIAGRAM

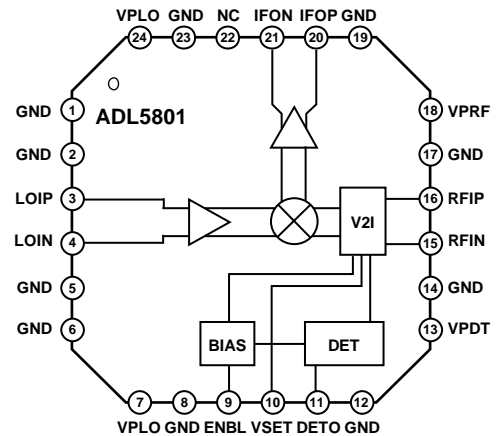

Figure 1.

The balanced active mixer arrangement provides superb LO-to-RF and LO-to-IF leakage, typically better than -40 dBm. The IF outputs are designed to provide a typical voltage conversion gain of 7.8 dB when loaded into a 200 Ω load. The broad frequency range of the open-collector IF outputs allows the **ADL5801** to be applied as an upconverter for various transmit applications.

The **ADL5801** is fabricated using a SiGe high performance IC process. The device is available in a compact 4 mm × 4 mm, 24-lead LFCSP package and operates over a -40°C to +85°C temperature range. An evaluation board is also available.

ADL5801* Product Page Quick Links

Last Content Update: 10/05/2016

[Comparable Parts](#)

View a parametric search of comparable parts

[Evaluation Kits](#)

- ADL5801 Evaluation Board

[Documentation](#)

Data Sheet

- ADL5801: High IP3, 10 MHz to 6 GHz, Active Mixer Data Sheet

[Tools and Simulations](#)

- ADIsimPLL™
- ADIsimRF

[Reference Designs](#)

- CN0239
- CN0360

[Reference Materials](#)

Press

- Analog Devices' 4-GHz PLL Synthesizer Offers Leading Phase Noise Performance
- New Analog Devices' PLL Synthesizers Deliver Utmost Flexibility and Phase Noise Performance
- New PLLs Deliver Widest Frequency Range Coverage and Lowest VCO Phase Noise in a Single Device

Product Selection Guide

- RF Source Booklet

Technical Articles

- MS-2739: High Dynamic IF Receiver Simplifies Design of Next Generation μ W Point-to-Point Modems

[Design Resources](#)

- ADL5801 Material Declaration
- PCN-PDN Information
- Quality And Reliability
- Symbols and Footprints

[Discussions](#)

View all ADL5801 EngineerZone Discussions

[Sample and Buy](#)

Visit the product page to see pricing options

[Technical Support](#)

Submit a technical question or find your regional support number

www.BDTIC.com/en/adi

TABLE OF CONTENTS

Features	1	Circuit Description.....	27
Applications.....	1	LO Amplifier and Splitter.....	27
Functional Block Diagram	1	RF Voltage-to-Current (V-to-I) Converter.....	27
General Description	1	Mixer Core	27
Revision History	2	Mixer Output Load	27
Specifications.....	3	RF Detector	28
Absolute Maximum Ratings.....	6	Bias Circuit.....	28
ESD Caution.....	6	Applications Information	31
Pin Configuration and Function Descriptions.....	7	Basic Connections.....	31
Typical Performance Characteristics	8	RF and LO Ports.....	31
Downconverter Mode with a Broadband Balun	8	IF Port.....	32
Downconverter Mode with a Mini-Circuits® TC1-1-43M+ Input Balun.....	12	Downconverting to Low Frequencies.....	33
Downconverter Mode with a Johanson 3.5 GHz Input Balun.....	14	Broadband Operation.....	34
Downconverter Mode with a Johanson 5.7 GHz Input Balun.....	16	Single-Ended Drive of RF and LO Inputs.....	36
Upconverter Mode with a 900 MHz Output Match	18	Evaluation Board.....	38
Upconverter Mode with a 2.1 GHz Output Match.....	20	Outline Dimensions	40
Spur Performance.....	23	Ordering Guide	40

REVISION HISTORY

4/14—Rev. D to Rev. E

Changes to Figure 1	1
Changes to Table 1	4
Changes to Figure 87 and Deleted Table 4; Renumbered Sequentially	27
Changes to RF Detector Section and Bias Circuit Section; Added Table 4 and Table 5; Renumbered Sequentially, and Added Figure 92, Figure 93, Figure 94, and Figure 95; Renumbered Sequentially.....	29

3/14—Rev. C to Rev. D

Changes to Pin 9, Table 3.....	7
--------------------------------	---

8/13—Rev. B to Rev. C

Changes to Table 8.....	38
-------------------------	----

7/13—Rev. A to Rev. B

Added Disable Voltage and Enable Voltage; Table 1.....	3
Changes to Table 5 and Figure 96.....	31

Added Downconverting to Low Frequencies Section and Figure 97; Renumbered Sequentially.....	32
Added Broadband Operation Section and Figure 98 to Figure 101	33
Added Single-Ended Drive of RF and LO Inputs Section and Figure 102 to Figure 105.....	35
Updated Outline Dimensions	39

7/11—Rev. 0 to Rev. A

Changes to Specifications Section.....	3
Changes to Typical Performance Characteristics Section	8
Changes to Spur Performance Section	23
Changes to RF Voltage-to-Current (V-to-I) Converter Section.....	27
Changes to RF Detector Section.....	28
Changes to RF and LO Ports Section.....	30

2/10—Revision 0: Initial Version

SPECIFICATIONS

$V_S = 5\text{ V}$, $T_A = 25^\circ\text{C}$, $f_{RF} = 900\text{ MHz}$, $f_{LO} = (f_{RF} - 153\text{ MHz})$, LO power = 0 dBm, $Z_0^1 = 50\ \Omega$, VSET = 3.6 V, unless otherwise noted.

Table 1.

Parameter	Test Conditions	Min	Typ	Max	Unit
RF INPUT INTERFACE					
Return Loss	Tunable to >20 dB over a limited bandwidth		12		dB
Input Impedance			50		Ω
RF Frequency Range		10		6000	MHz
OUTPUT INTERFACE					
Output Impedance	Differential impedance, $f = 200\text{ MHz}$		230		Ω
IF Frequency Range	Can be matched externally to 3000 MHz	LF		600	MHz
DC Bias Voltage ²	Externally generated	4.75	V_S	5.25	V
LO INTERFACE					
LO Power		-10	0	+10	dBm
Return Loss			15		dB
Input Impedance			50		Ω
LO Frequency Range		10		6000	MHz
POWER INTERFACE					
Supply Voltage		4.75	5	5.25	V
Quiescent Current	Resistor programmable		130	200	mA
Disable Current	ENBL pin high to disable the device		50		mA
Disable Voltage	ENBL pin high to disable the device	2.5		5	V
Enable Voltage	ENBL pin low to enable the device	0		1.8	V
Enable Time	Time from ENBL pin low to enable		182		ns
Disable Time	Time from ENBL pin high to disable		28		ns
DYNAMIC PERFORMANCE at $f_{RF} = 900\text{ MHz}/1900\text{ MHz}$ ³					
Power Conversion Gain ⁴	$f_{RF} = 900\text{ MHz}$		1.8		dB
	$f_{RF} = 1900\text{ MHz}$		1.8		dB
Voltage Conversion Gain ⁵	$f_{RF} = 900\text{ MHz}$		7.8		dB
	$f_{RF} = 1900\text{ MHz}$		7.8		dB
SSB Noise Figure	$f_{CENT} = 900\text{ MHz}$, VSET = 2.0 V		9.75		dB
	$f_{CENT} = 1900\text{ MHz}$, VSET = 2.0 V		11.5		dB
SSB Noise Figure Under Blocking ⁶	$f_{CENT} = 900\text{ MHz}$		19.5		dB
	$f_{CENT} = 1900\text{ MHz}$		20		dB
Input Third-Order Intercept ⁷	$f_{CENT} = 900\text{ MHz}$		28.5		dBm
	$f_{CENT} = 1900\text{ MHz}$		26.4		dBm
Input Second-Order Intercept ⁸	$f_{CENT} = 900\text{ MHz}$		63		dBm
	$f_{CENT} = 1900\text{ MHz}$		49.7		dBm
Input 1 dB Compression Point	$f_{RF} = 900\text{ MHz}$		13.3		dBm
	$f_{RF} = 1900\text{ MHz}$		12.7		dBm
LO-to-IF Output Leakage	Unfiltered IF output		-27		dBm
LO-to-RF Input Leakage			-30		dBm
RF-to-IF Output Isolation			-35		dBc
IF/2 Spurious ⁹	0 dBm input power, $f_{RF} = 900\text{ MHz}$		-67.5		dBc
	0 dBm input power, $f_{RF} = 1900\text{ MHz}$		-53		dBc
IF/3 Spurious ⁹	0 dBm input power, $f_{RF} = 900\text{ MHz}$		-65.5		dBc
	0 dBm input power, $f_{RF} = 1900\text{ MHz}$		-72.6		dBc

Parameter	Test Conditions	Min	Typ	Max	Unit
DYNAMIC PERFORMANCE at $f_{RF} = 2500$ MHz ¹⁰					
Power Conversion Gain ¹¹			-6.1		dB
Voltage Conversion Gain ⁵			-0.1		dB
SSB Noise Figure	$f_{CENT} = 2500$ MHz, $V_{SET} = 2.0$ V		10.6		dB
Input Third-Order Intercept ¹²	$f_{CENT} = 2500$ MHz		25.5		dBm
Input Second-Order Intercept ¹³	$f_{CENT} = 2500$ MHz		45.3		dBm
Input 1 dB Compression Point	$f_{CENT} = 2500$ MHz		13.8		dBm
LO-to-IF Output Leakage	Unfiltered IF output		-31.5		dBm
LO-to-RF Input Leakage			-31.2		dBm
RF-to-IF Output Isolation			-42.5		dBc
IF/2 Spurious ⁹	0 dBm input power, $f_{RF} = 2600$ MHz		-50.6		dBc
IF/3 Spurious ⁹	0 dBm input power, $f_{RF} = 2600$ MHz		-59.8		dBc
DYNAMIC PERFORMANCE at $f_{RF} = 3500$ MHz ¹⁴					
Power Conversion Gain ¹⁵			-6.44		dB
Voltage Conversion Gain ⁵			-0.44		dB
SSB Noise Figure	$f_{CENT} = 3500$ MHz, $V_{SET} = 3.6$ V		15.8		dB
Input Third-Order Intercept ⁷	$f_{CENT} = 3500$ MHz, $V_{SET} = 3.6$ V		26.5		dBm
Input Second-Order Intercept ⁸	$f_{CENT} = 3500$ MHz, $V_{SET} = 3.6$ V		42.3		dBm
Input 1 dB Compression Point			12.5		dBm
LO-to-IF Output Leakage	Unfiltered IF output		-30.2		dBm
LO-to-RF Input Leakage			-29.4		dBm
RF-to-IF Output Isolation			-29.7		dBc
IF/2 Spurious ⁹	0 dBm input power, $f_{RF} = 3800$ MHz		-47.1		dBc
IF/3 Spurious ⁹	0 dBm input power, $f_{RF} = 3800$ MHz		-57.8		dBc
DYNAMIC PERFORMANCE at $f_{RF} = 5500$ MHz ¹⁶					
Power Conversion Gain ¹⁷			-5.2		dB
Voltage Conversion Gain ⁵			0.8		dB
SSB Noise Figure	$f_{CENT} = 5500$ MHz, $V_{SET} = 3.6$ V		16.2		dB
Input Third-Order Intercept ⁷	$f_{CENT} = 5500$ MHz, $V_{SET} = 3.6$ V		22.7		dBm
Input Second-Order Intercept ⁸	$f_{CENT} = 5500$ MHz, $V_{SET} = 3.6$ V		35.4		dBm
Input 1 dB Compression Point			11.3		dBm
LO-to-IF Output Leakage	Unfiltered IF output		-42.6		dBm
LO-to-RF Input Leakage			-28.9		dBm
RF-to-IF Output Isolation			-46.7		dBc
IF/2 Spurious ⁹	0 dBm input power, $f_{RF} = 5800$ MHz		-44		dBc
IF/3 Spurious ⁹	0 dBm input power, $f_{RF} = 5800$ MHz		-47		dBc
DYNAMIC PERFORMANCE at $f_{IF} = 900$ MHz ¹⁸					
Power Conversion Gain ¹⁹			-6		dB
Voltage Conversion Gain ⁵			0		dB
SSB Noise Figure	$f_{IF} = 900$ MHz, $f_{RF} = 250$ MHz, $V_{SET} = 2.0$ V		10.6		dB
Output Third-Order Intercept ²⁰	$f_{CENT} = 153$ MHz, $V_{SET} = 3.6$ V		30.6		dBm
Output Second-Order Intercept ²¹	$f_{CENT} = 153$ MHz, $V_{SET} = 3.6$ V		68.7		dBm
Output 1 dB Compression Point			11.1		dBm
LO-to-IF Output Leakage	Unfiltered IF output		-33.8		dBm
LO-to-RF Input Leakage			-33.4		dBm
IF/2 Spurious ⁹	0 dBm input power, $f_{RF} = 140$ MHz, $f_{IF} = 806$ MHz		-62.6		dBc
IF/3 Spurious ⁹	0 dBm input power, $f_{RF} = 140$ MHz, $f_{IF} = 806$ MHz		-68.9		dBc

Parameter	Test Conditions	Min	Typ	Max	Unit
DYNAMIC PERFORMANCE at $f_{IF} = 2140 \text{ MHz}^{22}$					
Power Conversion Gain ²³			-7.25		dB
Voltage Conversion Gain ⁵			-1.25		dB
SSB Noise Figure	$f_{IF} = 2140 \text{ MHz}, f_{RF} = 190 \text{ MHz}, V_{SET} = 2.0 \text{ V}$		13.6		dB
Output Third-Order Intercept ²⁴	$f_{CENT} = 170 \text{ MHz}, V_{SET} = 3.6 \text{ V}$		24		dBm
Output Second-Order Intercept ²⁵	$f_{CENT} = 170 \text{ MHz}, V_{SET} = 3.6 \text{ V}$		70		dBm
Output 1 dB Compression Point			9.9		dBm
LO-to-IF Output Leakage	Unfiltered IF output		-23.8		dBm
LO-to-RF Input Leakage			-33.2		dBm
IF/2 Spurious ⁹	0 dBm input power, $f_{RF} = 140 \text{ MHz}, f_{IF} = 2210 \text{ MHz}$		-51.5		dBc

¹ Z_0 is the characteristic impedance assumed for all measurements and the PCB.

² Supply voltage must be applied from an external circuit through choke inductors

³ $V_S = 5 \text{ V}, T_A = 25^\circ\text{C}, f_{RF} = 900 \text{ MHz}/1900 \text{ MHz}, f_{LO} = (f_{RF} - 153 \text{ MHz}), \text{LO power} = 0 \text{ dBm}, Z_0^1 = 50 \Omega, V_{SET} = 3.8 \text{ V}$, unless otherwise noted.

⁴ Excluding 4:1 IF port transformer (TC4-1W+), RF and LO port transformers (TC1-1-13M+), and PCB loss.

⁵ $Z_{SOURCE} = 50 \Omega$, differential; $Z_{LOAD} = 200 \Omega$ differential; Z_{SOURCE} is the impedance of the source instrument; Z_{LOAD} is the load impedance at the output.

⁶ $f_{RF} = f_{CENT}, f_{BLOCKER} = (f_{CENT} - 5) \text{ MHz}, f_{LO} = (f_{CENT} - 153) \text{ MHz}$, blocker level = 0 dBm.

⁷ $f_{RF1} = (f_{CENT} - 1) \text{ MHz}, f_{RF2} = (f_{CENT}) \text{ MHz}, f_{LO} = (f_{CENT} - 153) \text{ MHz}$, each RF tone at -10 dBm.

⁸ $f_{RF1} = (f_{CENT}) \text{ MHz}, f_{RF2} = (f_{CENT} + 100) \text{ MHz}, f_{LO} = (f_{CENT} - 153) \text{ MHz}$, each RF tone at -10 dBm.

⁹ For details, see the Spur Performance section.

¹⁰ $V_S = 5 \text{ V}, T_A = 25^\circ\text{C}, f_{RF} = 2500 \text{ MHz}, f_{LO} = (f_{RF} - 211 \text{ MHz}), \text{LO power} = 0 \text{ dBm}, Z_0^1 = 50 \Omega, V_{SET} = 3.8 \text{ V}$, unless otherwise noted.

¹¹ Including 4:1 IF port transformer (TC4-1W+), RF and LO port transformers (TC1-1-43M+ and TC1-1-13M+ respectively), and PCB loss.

¹² $f_{RF1} = (f_{CENT} - 1) \text{ MHz}, f_{RF2} = (f_{CENT}) \text{ MHz}, f_{LO} = (f_{CENT} - 211) \text{ MHz}$, each RF tone at -10 dBm.

¹³ $f_{RF1} = (f_{CENT}) \text{ MHz}, f_{RF2} = (f_{CENT} + 100) \text{ MHz}, f_{LO} = (f_{CENT} - 211) \text{ MHz}$, each RF tone at -10 dBm

¹⁴ $V_S = 5 \text{ V}, T_A = 25^\circ\text{C}, f_{RF} = 3500 \text{ MHz}, f_{LO} = (f_{RF} - 153 \text{ MHz}), \text{LO power} = 0 \text{ dBm}, Z_0^1 = 50 \Omega, V_{SET} = 3.6 \text{ V}$, unless otherwise noted.

¹⁵ Including 4:1 IF port transformer (TC4-1W+), RF and LO port transformers (3600BL14M050), and PCB loss.

¹⁶ $V_S = 5 \text{ V}, T_A = 25^\circ\text{C}, f_{RF} = 5500 \text{ MHz}, f_{LO} = (f_{RF} - 153 \text{ MHz}), \text{LO power} = 0 \text{ dBm}, Z_0^1 = 50 \Omega, V_{SET} = 3.6 \text{ V}$, unless otherwise noted.

¹⁷ Including 4:1 IF port transformer (TC4-1W+), RF and LO port transformers (5400BL14B050), and PCB loss.

¹⁸ $V_S = 5 \text{ V}, T_A = 25^\circ\text{C}, f_{RF} = 153 \text{ MHz}, f_{LO} = (f_{RF} + 900 \text{ MHz}), \text{LO power} = 0 \text{ dBm}, Z_0^1 = 50 \Omega, V_{SET} = 3.6 \text{ V}$, unless otherwise noted.

¹⁹ Including 4:1 IF port transformer (TC4-14+), RF and LO transformers (TC1-1-13M+), and PCB loss.

²⁰ $f_{RF1} = (f_{CENT} - 1) \text{ MHz}, f_{RF2} = (f_{CENT}) \text{ MHz}, f_{LO} = (f_{CENT} + 900 \text{ MHz})$, each RF tone at -10 dBm.

²¹ $f_{RF1} = (f_{CENT}) \text{ MHz}, f_{RF2} = (f_{CENT} + 100) \text{ MHz}, f_{LO} = (f_{CENT} + 900) \text{ MHz}$, each RF tone at -10 dBm.

²² $V_S = 5 \text{ V}, T_A = 25^\circ\text{C}, f_{RF} = 153 \text{ MHz}, f_{LO} = (f_{RF} + 2140 \text{ MHz}), \text{LO power} = 0 \text{ dBm}, Z_0^1 = 50 \Omega, V_{SET} = 4 \text{ V}$, unless otherwise noted.

²³ Including 4:1 IF port transformer (1850BL15B200), RF and LO port transformers (TC1-1-13M+), and PCB loss.

²⁴ $f_{RF1} = (f_{CENT} - 1) \text{ MHz}, f_{RF2} = (f_{CENT}) \text{ MHz}, f_{LO} = (f_{CENT} + 2140 \text{ MHz})$, each RF tone at -10 dBm.

²⁵ $f_{RF1} = (f_{CENT}) \text{ MHz}, f_{RF2} = (f_{CENT} + 100) \text{ MHz}, f_{LO} = (f_{CENT} + 2140) \text{ MHz}$, each RF tone at -10 dBm.

ABSOLUTE MAXIMUM RATINGS

Table 2.

Parameter	Rating
Supply Voltage, VPOS	5.5 V
VSET, ENBL	5.5 V
IFOP, IFON	5.5 V
RFIN Power	20 dBm
Internal Power Dissipation	1.2 W
θ_{JA} (Exposed Paddle Soldered Down) ¹	26.5°C/W
θ_{JC} (at Exposed Paddle)	8.7°C/W
Maximum Junction Temperature	150°C
Operating Temperature Range	−40°C to +85°C
Storage Temperature Range	−65°C to +150°C

¹ As measured on the evaluation board. For details, see the Evaluation Board section.

Stresses above those listed under Absolute Maximum Ratings may cause permanent damage to the device. This is a stress rating only; functional operation of the device at these or any other conditions above those indicated in the operational section of this specification is not implied. Exposure to absolute maximum rating conditions for extended periods may affect device reliability.

ESD CAUTION



ESD (electrostatic discharge) sensitive device. Charged devices and circuit boards can discharge without detection. Although this product features patented or proprietary protection circuitry, damage may occur on devices subjected to high energy ESD. Therefore, proper ESD precautions should be taken to avoid performance degradation or loss of functionality.

www.BDTIC.com/cn/adi

PIN CONFIGURATION AND FUNCTION DESCRIPTIONS

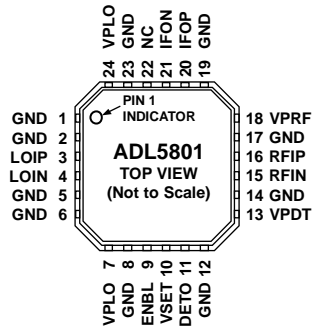

- NOTES**
1. THERE IS AN EXPOSED PADDLE THAT MUST BE SOLDERED TO GROUND.
 2. NC = NO CONNECT.

08079-002

Figure 2. Pin Configuration

Table 3. Pin Function Descriptions

Pin No.	Mnemonic	Description
1, 2, 5, 6, 8, 12, 14, 17, 19, 23	GND	Device Common (DC Ground).
3, 4	LOIP, LOIN	Differential LO Input Terminal. Internally matched to 50 Ω. Must be ac-coupled.
7, 24	VPLO	Positive Supply Voltage for LO System.
9	ENBL	Detector and Mixer Bias Enable. Pull the pin high to disable the internal detector and mixer bias circuit. The device can be operated in this mode by setting the bias level using an external supply or connecting a resistor from the VSET pin to the positive supply. See the Circuit Description section for more details. Pull the pin low to enable the internal detector and mixer bias circuit.
10	VSET	Input IP3 Bias Adjustment. The voltage presented to the VSET pin sets the internal bias of the mixer core and allows for adaptive control of the input IP3 and NF characteristics of the mixer core.
11	DETO	Detector Output. The DETO pin should be loaded with a capacitor to ground. The developed voltage is proportional to the rms input level. When the DETO output voltage is connected to the VSET input pin, the part auto biases and increases input IP3 performance when presented with large signal input levels.
13	VPDT	Positive Supply Voltage for Detector.
15, 16	RFIN, RFIP	Differential RF Input Terminal. Internally matched to 50 Ω differential input impedance. Must be ac-coupled.
18	VPRF	Positive Supply Voltage for RF Input System.
20, 21	IFOP, IFON	Differential IF Output Terminal. Bias must be applied through pull-up choke inductors or the center tap of the IF transformer.
22	NC	Not Connected.
	EPAD	The exposed paddle must be soldered to ground.

TYPICAL PERFORMANCE CHARACTERISTICS

DOWNCONVERTER MODE WITH A BROADBAND BALUN

$V_S = 5\text{ V}$, $T_A = 25^\circ\text{C}$, $V_{SET} = 3.8\text{ V}$, $IF = 153\text{ MHz}$, as measured using a typical circuit schematic with low-side local oscillator (LO), unless otherwise noted. Insertion loss of input and output baluns (TC1-1-13M+, TC4-1W+) is extracted from the gain measurement.

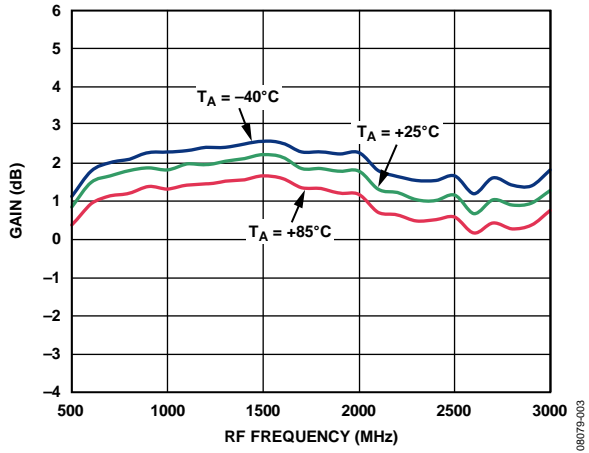

Figure 3. Power Conversion Gain vs. RF Frequency

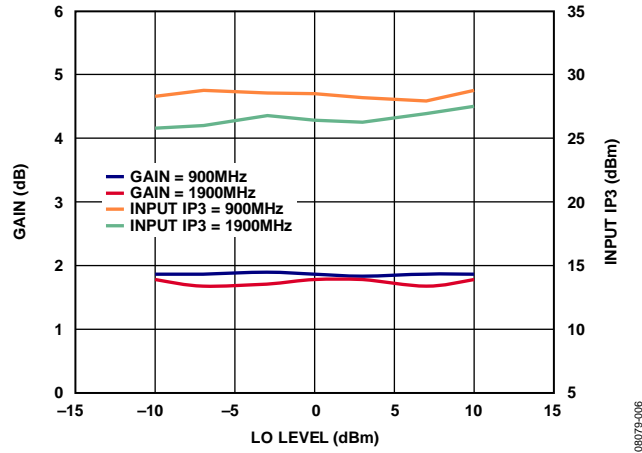

Figure 6. Power Conversion Gain and Input IP3 vs. LO Power

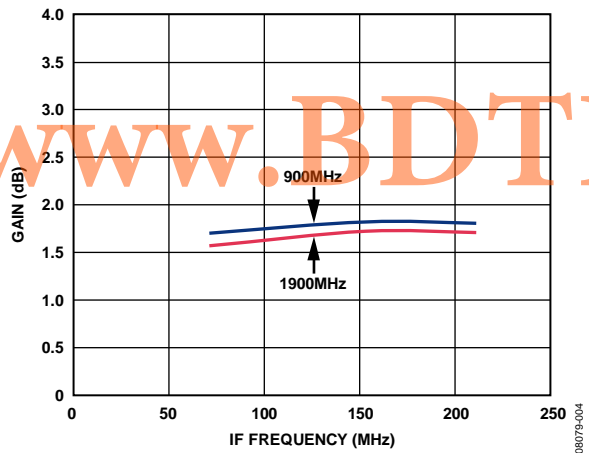

Figure 4. Power Conversion Gain vs. IF Frequency

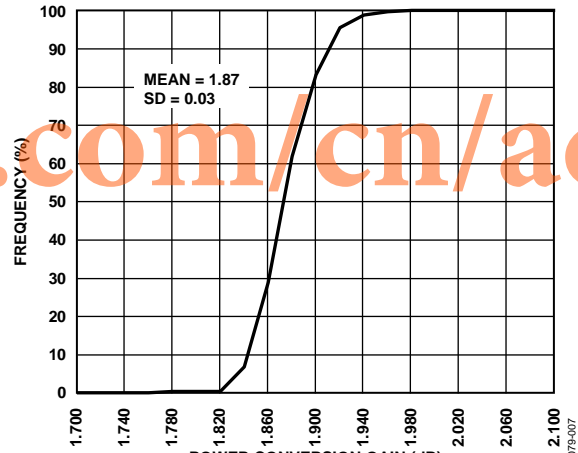

Figure 7. Power Conversion Gain Distribution

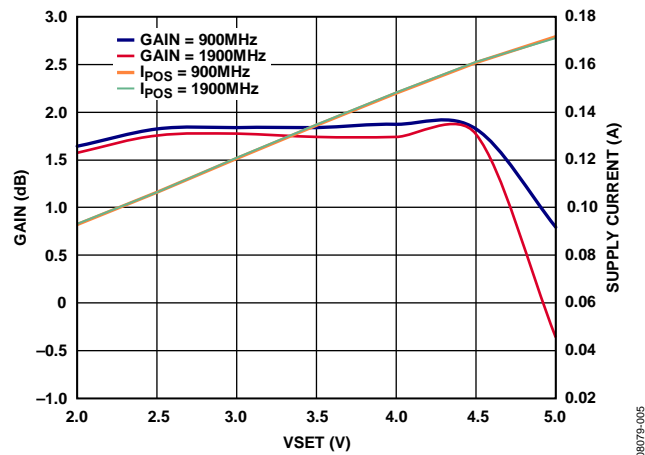

Figure 5. Power Conversion Gain and Supply Current vs. VSET

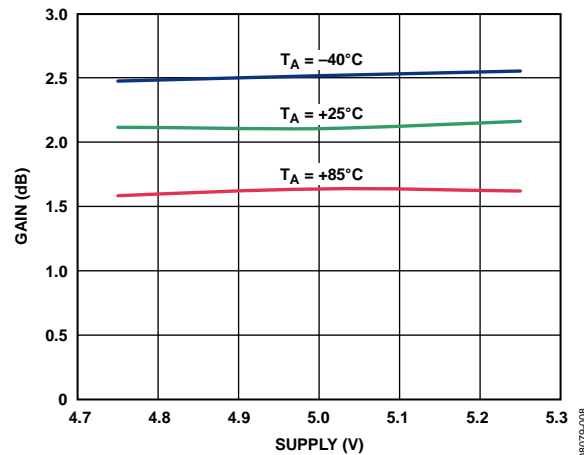

Figure 8. Power Conversion Gain vs. Supply Voltage

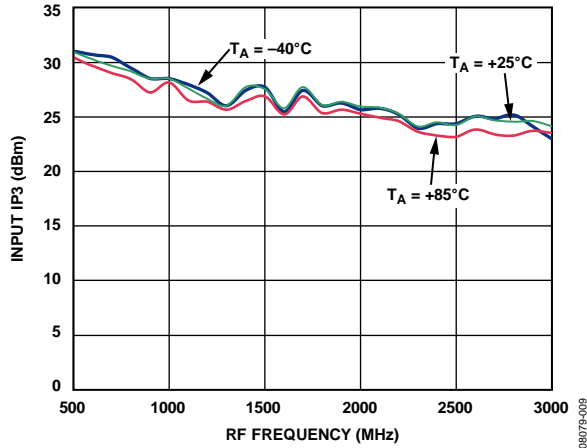

Figure 9. Input IP3 vs. RF Frequency

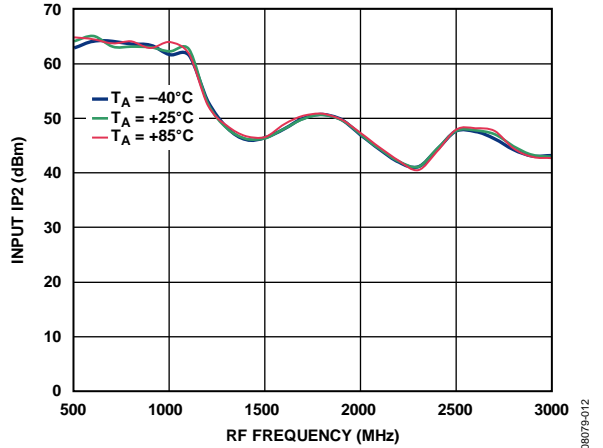

Figure 12. Input IP2 vs. RF Frequency

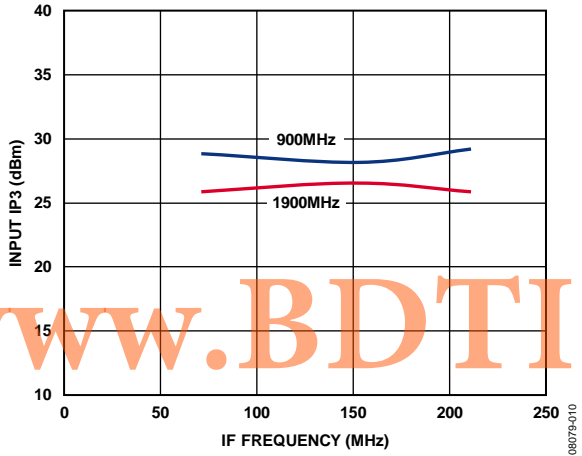

Figure 10. Input IP3 vs. IF Frequency

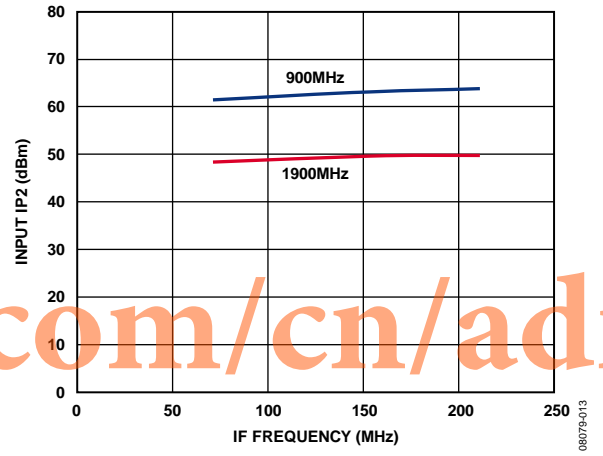

Figure 13. Input IP2 vs. IF Frequency

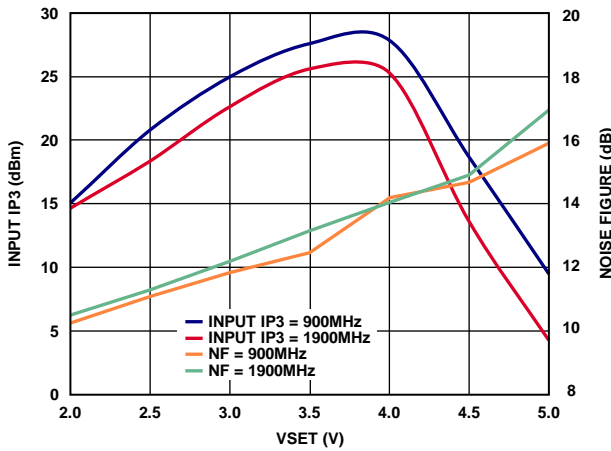

Figure 11. Input IP3 and Noise Figure vs. VSET

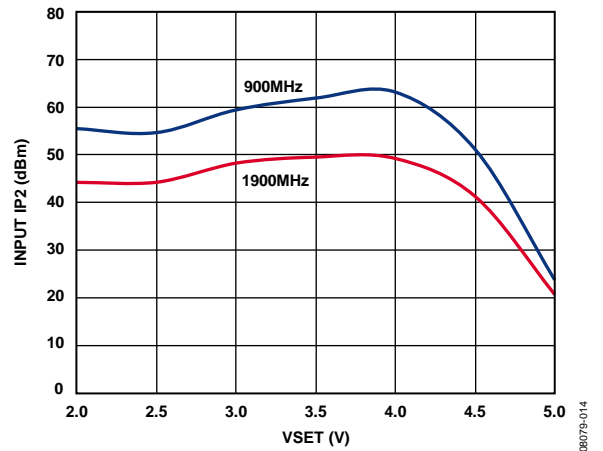

Figure 14. Input IP2 vs. VSET

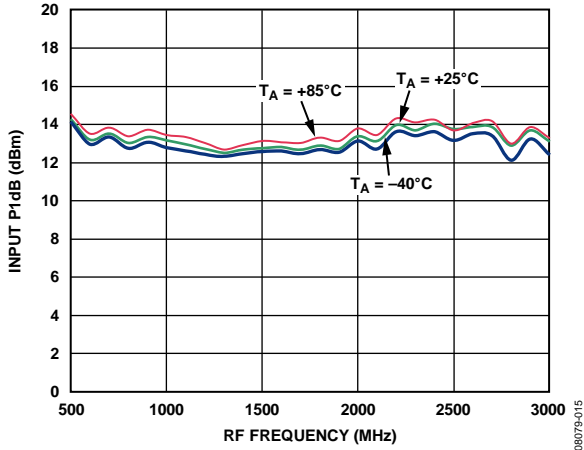

Figure 15. Input P1dB vs. RF Frequency

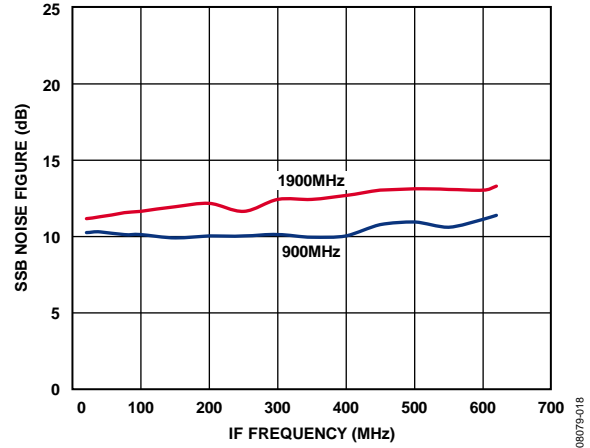

Figure 18. SSB Noise Figure vs. IF Frequency (VSET = 2.0 V)

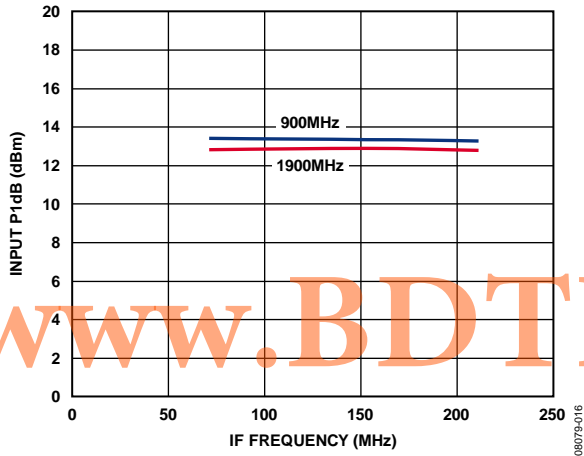

Figure 16. Input P1dB vs. IF Frequency

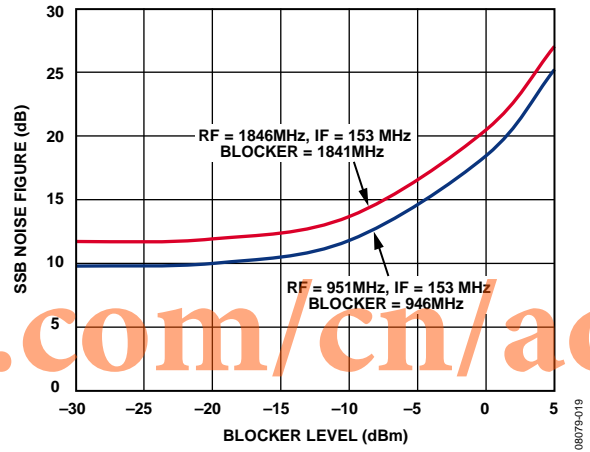

Figure 19. SSB Noise Figure vs. Blocker Level (VSET = 2.0 V)

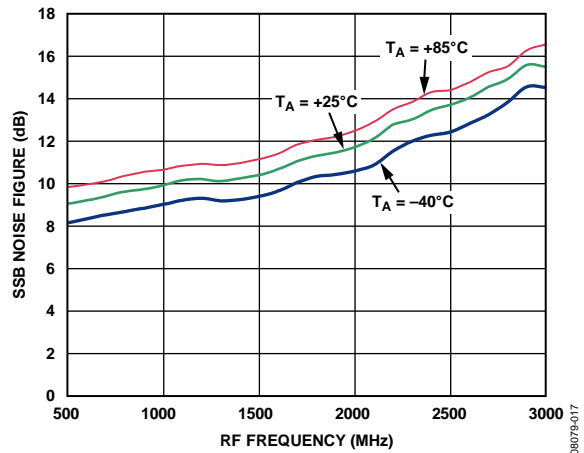

Figure 17. SSB Noise Figure vs. RF Frequency (VSET = 2.0 V)

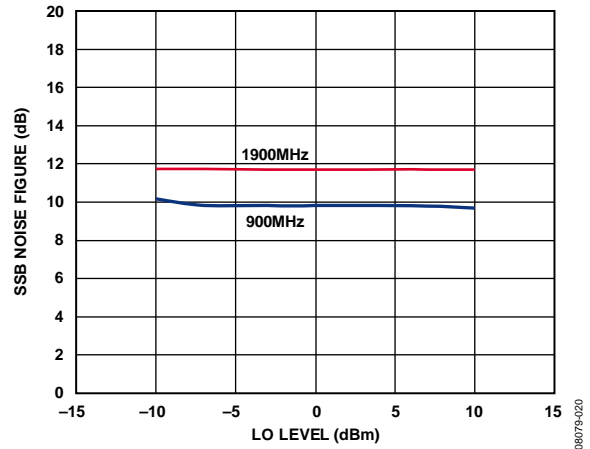

Figure 20. SSB Noise Figure vs. LO Power (VSET = 2.0 V)

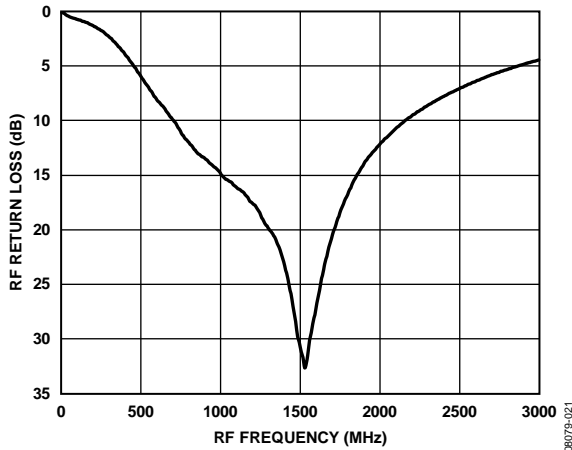

Figure 21. RF Return Loss vs. RF Frequency

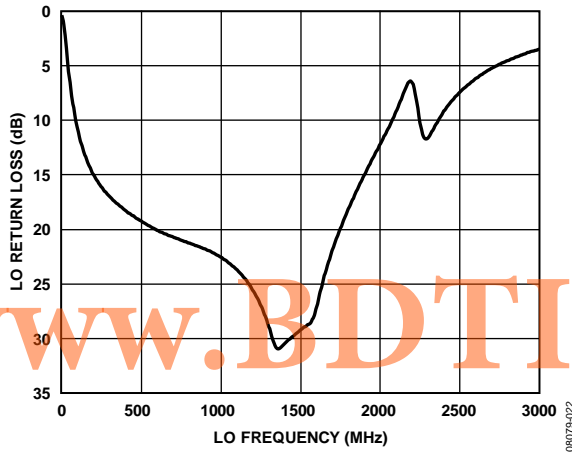

Figure 22. LO Return Loss vs. LO Frequency

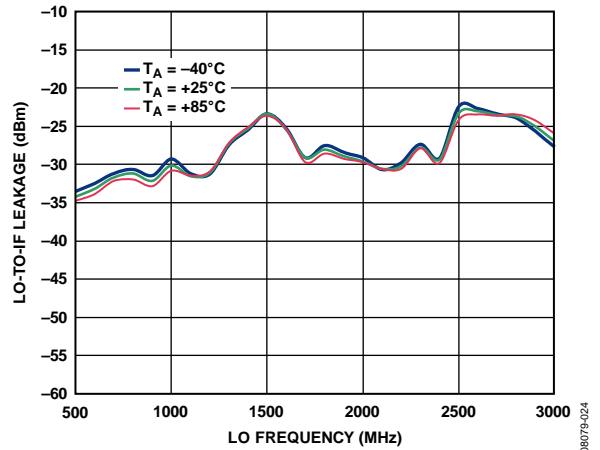

Figure 24. LO-to-IF Leakage vs. LO Frequency

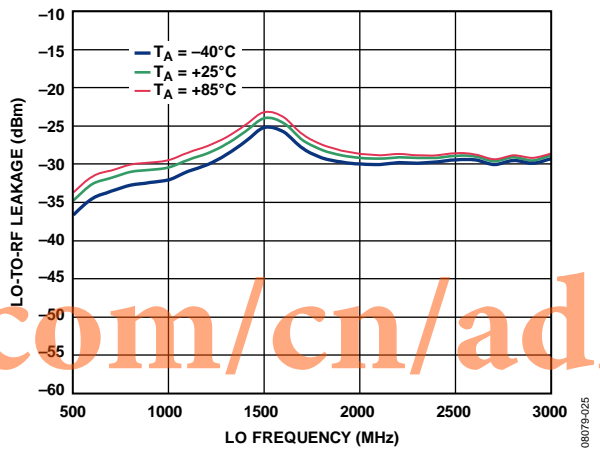

Figure 25. LO-to-RF Leakage vs. LO Frequency

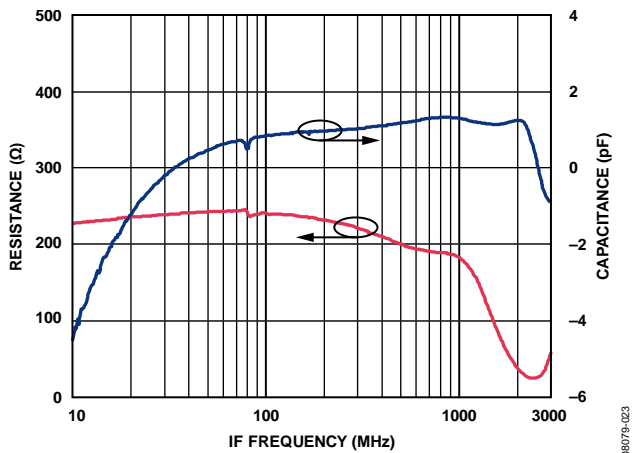

Figure 23. IF Differential Output Impedance (R Parallel C Equivalent)

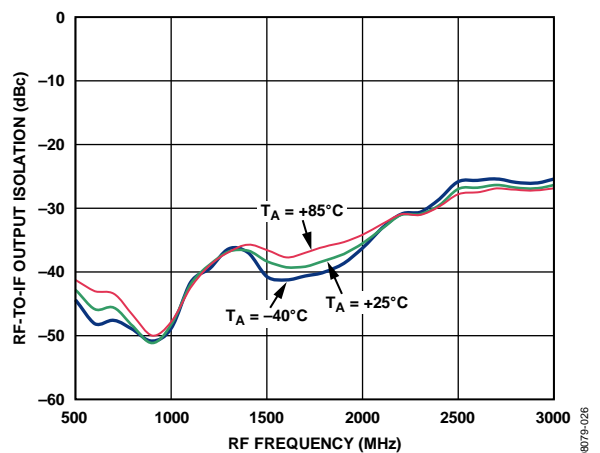

Figure 26. RF-to-IF Leakage vs. RF Frequency

DOWNCONVERTER MODE WITH A MINI-CIRCUITS® TC1-1-43M+ INPUT BALUN

$V_S = 5\text{ V}$, $T_A = 25^\circ\text{C}$, $V_{SET} = 3.8\text{ V}$, $I_F = 211\text{ MHz}$, as measured using a typical circuit schematic with low-side local oscillator (LO), unless otherwise noted. Insertion loss of input and output baluns (TC1-1-43M+, TC4-1W+) is included in the gain measurement.

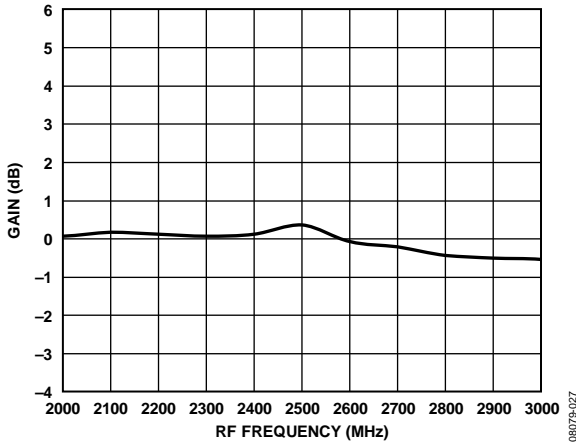

Figure 27. Power Conversion Gain vs. RF Frequency

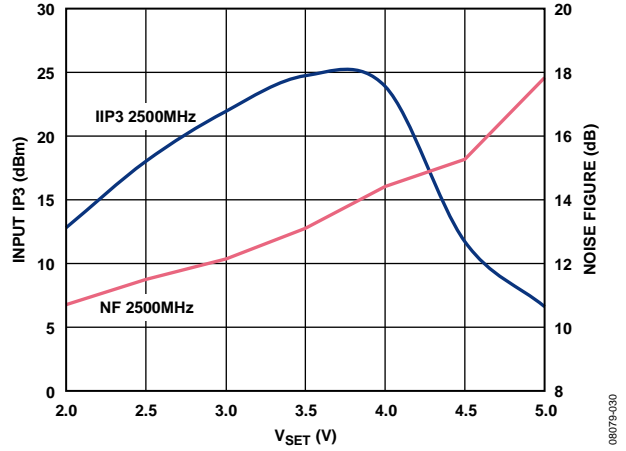

Figure 30. Input IP3 and Noise Figure vs. V_{SET}

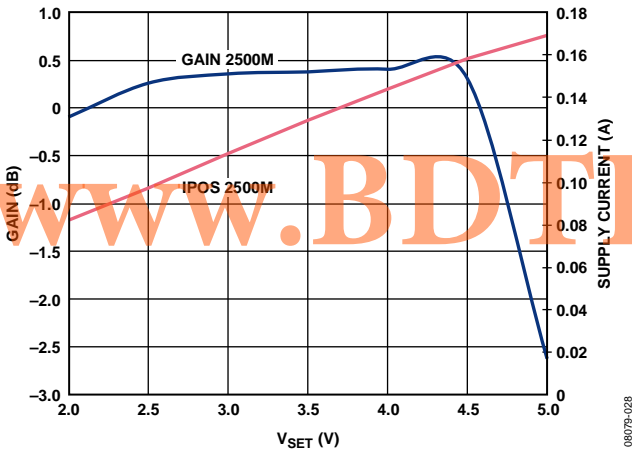

Figure 28. Power Conversion Gain and IPOS vs. V_{SET}

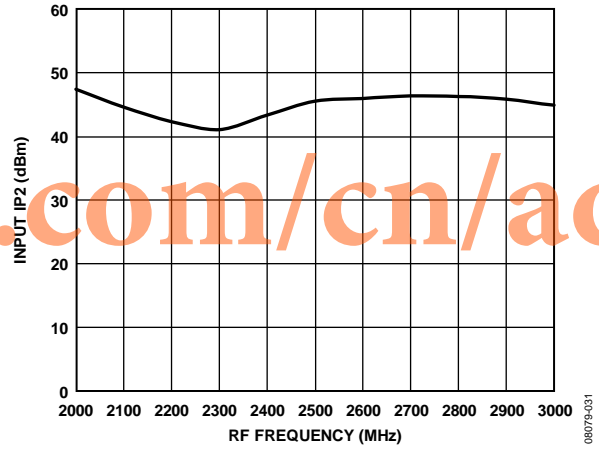

Figure 31. Input IP2 vs. RF Frequency

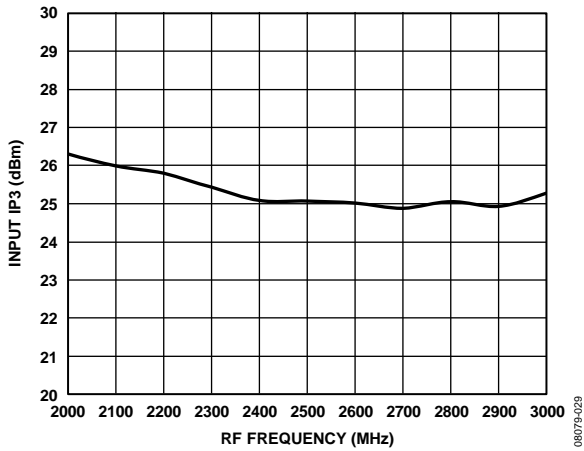

Figure 29. Input IP3 vs. RF Frequency

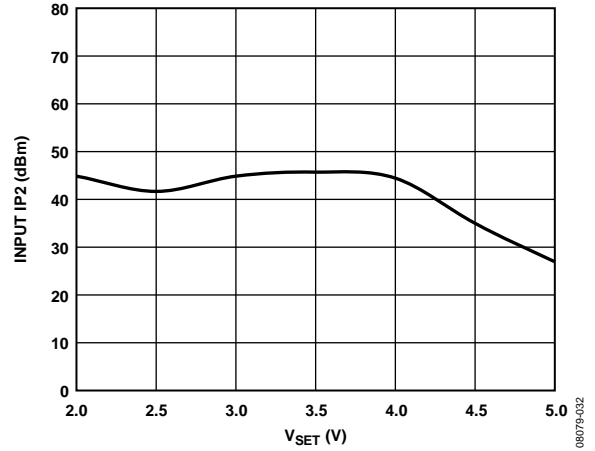

Figure 32. Input IP2 vs. V_{SET}

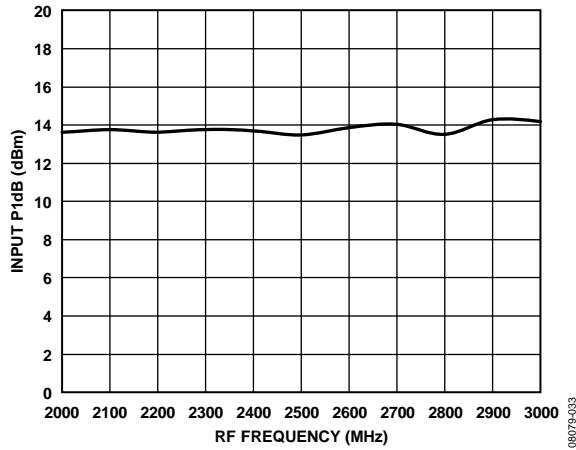

Figure 33. Input P1dB vs. RF Frequency

08079-033

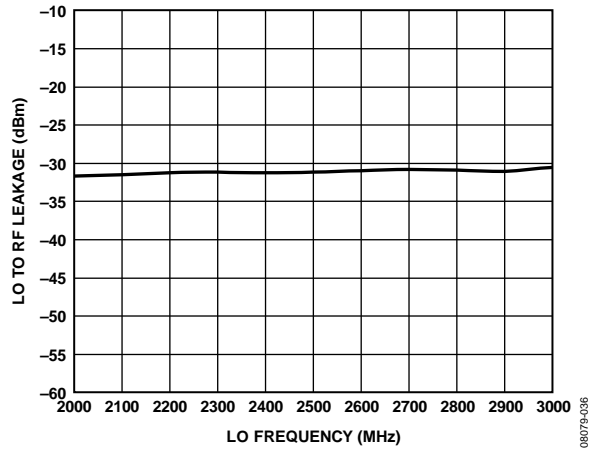

Figure 36. LO to RF Leakage vs. LO Frequency

08079-036

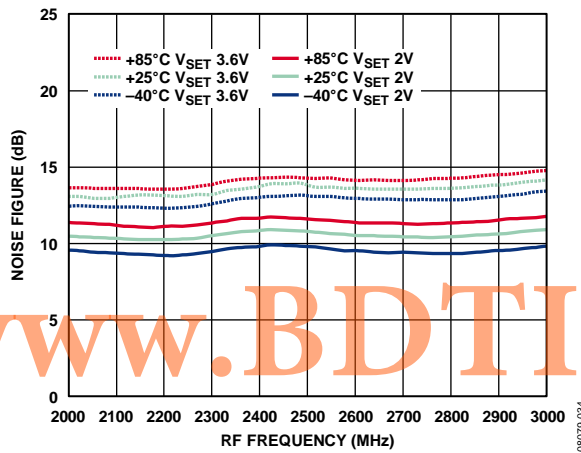

Figure 34. Noise Figure vs. RF Frequency

08079-034

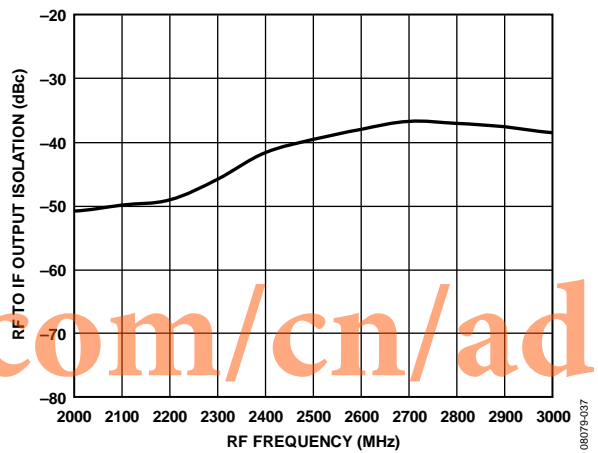

Figure 37. RF to IF Output Isolation vs. RF Frequency

08079-037

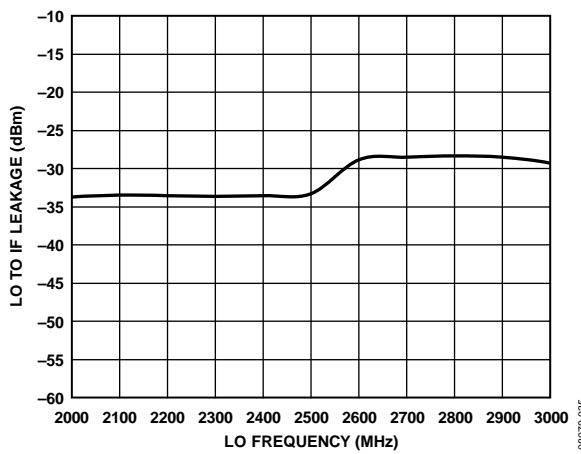

Figure 35. LO to IF Leakage vs. LO Frequency

08079-035

DOWNCONVERTER MODE WITH A JOHANSON 3.5 GHZ INPUT BALUN

$V_S = 5\text{ V}$, $T_A = 25^\circ\text{C}$, $V_{SET} = 3.6\text{ V}$, $IF = 153\text{ MHz}$, as measured using a typical circuit schematic with low-side local oscillator (LO), unless otherwise noted. Insertion loss of input and output baluns (3600BL14M050, TC4-1W+) is included in the gain measurement.

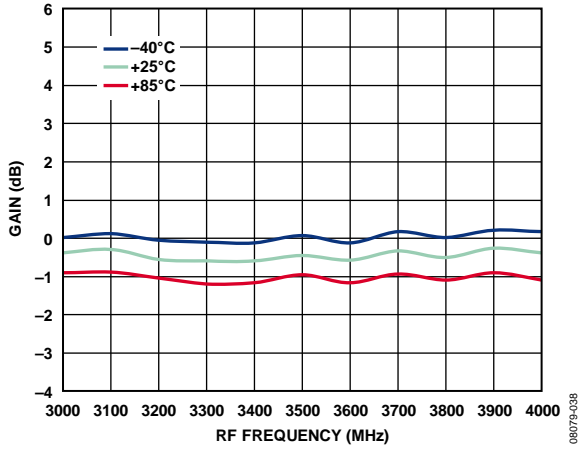

Figure 38. Power Conversion Gain vs. RF Frequency

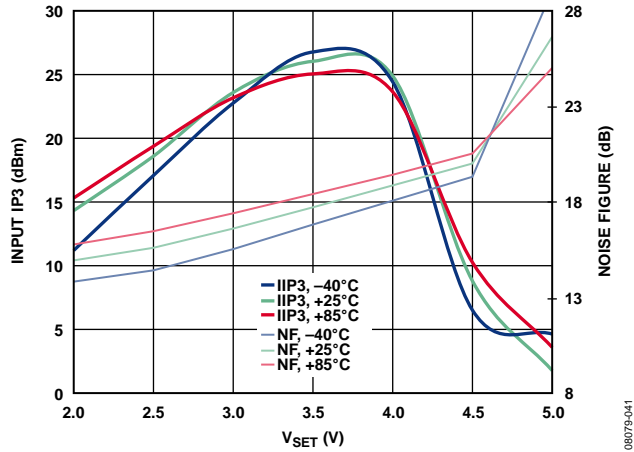

Figure 41. Input IP3 and Noise Figure vs. V_{SET}

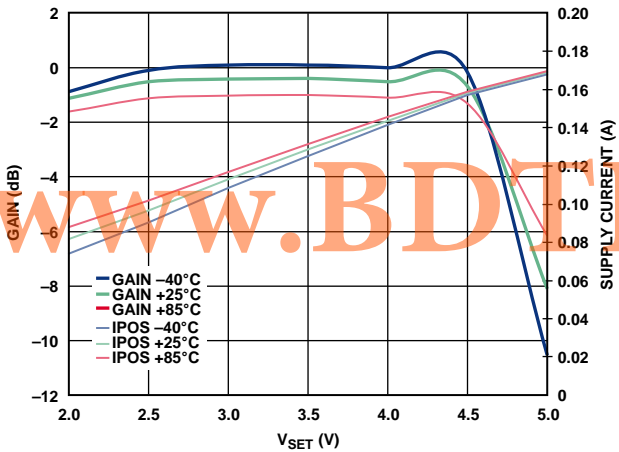

Figure 39. Power Conversion Gain and IPOS vs. V_{SET}

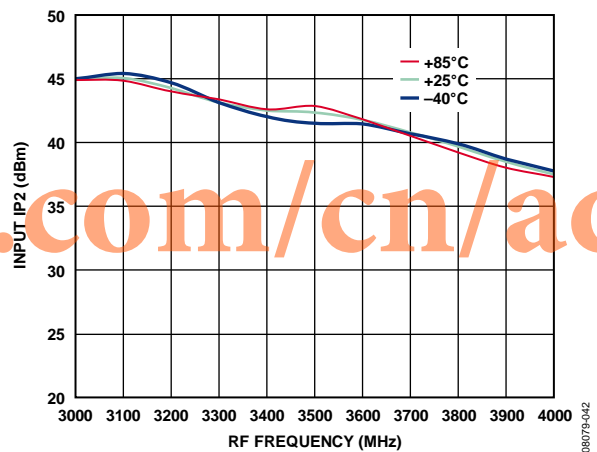

Figure 42. Input IP2 vs. RF Frequency

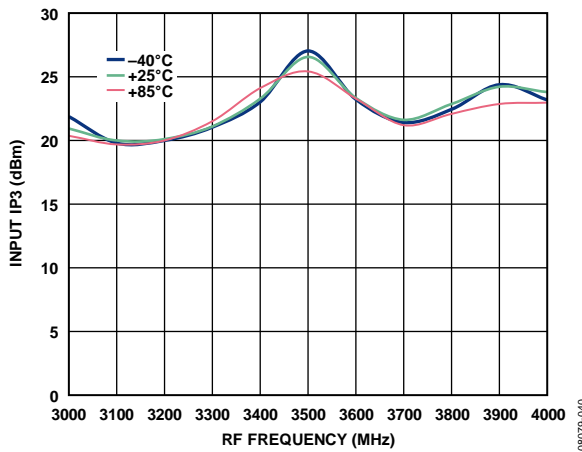

Figure 40. Input IP3 vs. RF Frequency

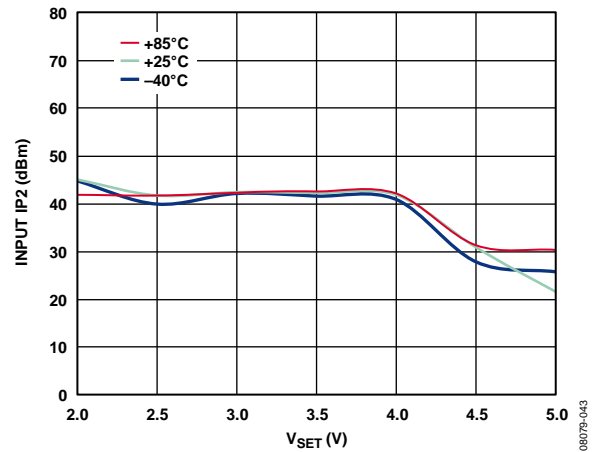

Figure 43. Input IP2 vs. V_{SET}

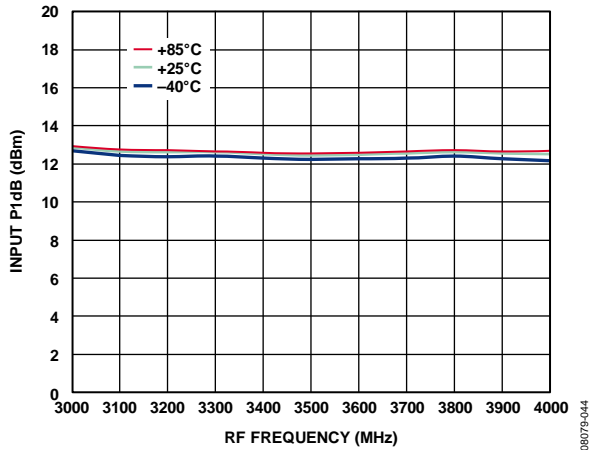

Figure 44. Input P1dB vs. RF Frequency

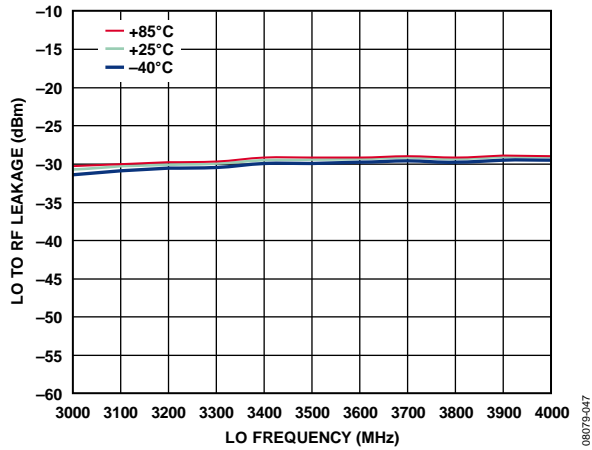

Figure 47. LO to RF Leakage vs. LO Frequency

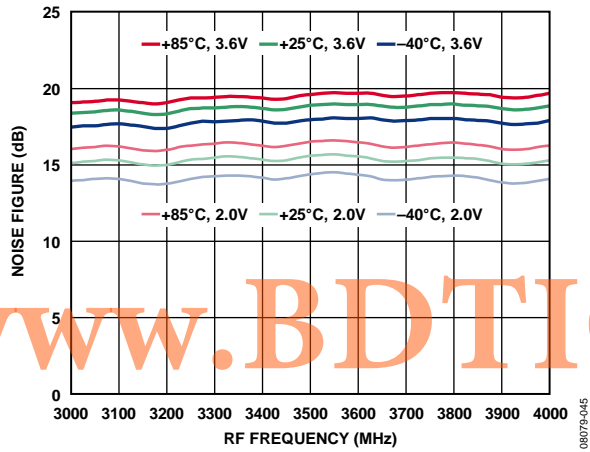

Figure 45. Noise Figure vs. RF Frequency

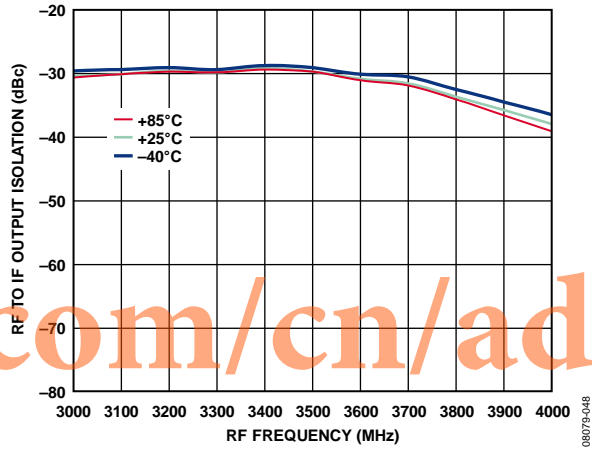

Figure 48. RF to IF Output Isolation vs. RF Frequency

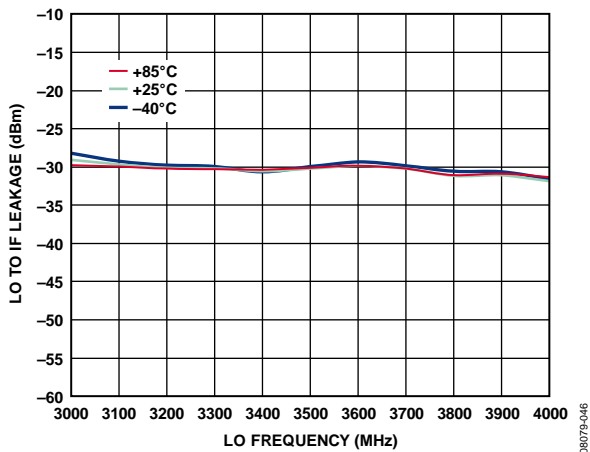

Figure 46. LO to IF Leakage vs. LO Frequency

DOWNCONVERTER MODE WITH A JOHANSON 5.7 GHZ INPUT BALUN

$V_S = 5\text{ V}$, $T_A = 25^\circ\text{C}$, $V_{SET} = 3.6\text{ V}$, $IF = 153\text{ MHz}$, as measured using a typical circuit schematic with low-side local oscillator (LO), unless otherwise noted. Insertion loss of input and output baluns (5400BL14B050, TC4-1W+) is included in the gain measurement.

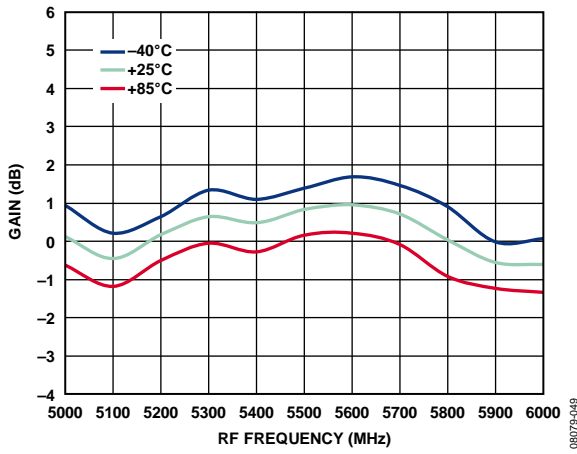

Figure 49. Power Conversion Gain vs. RF Frequency

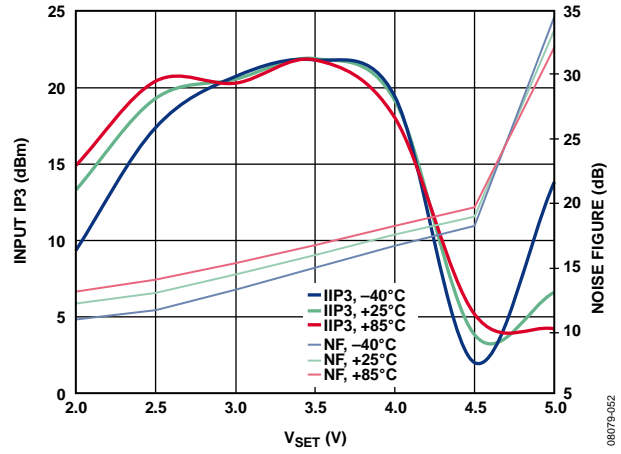

Figure 52. Input IP3 and Noise Figure vs. V_{SET}

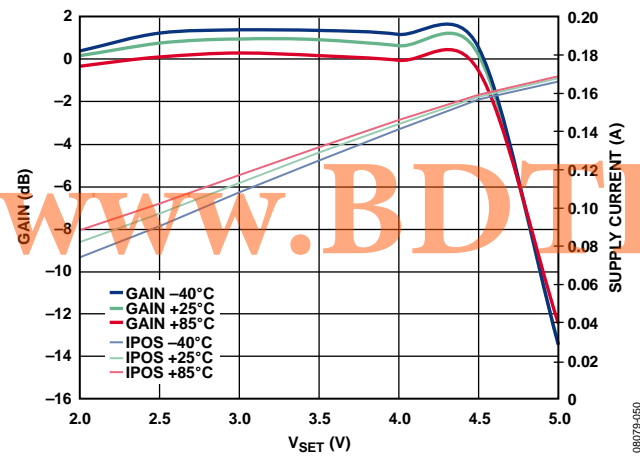

Figure 50. Power Conversion Gain and IPOS vs V_{SET}

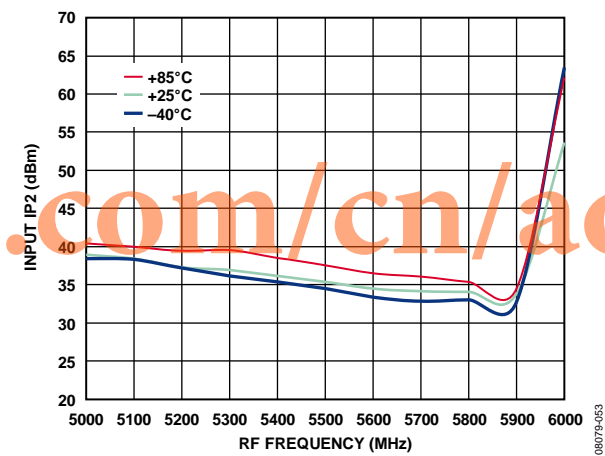

Figure 53. Input IP2 vs. RF Frequency

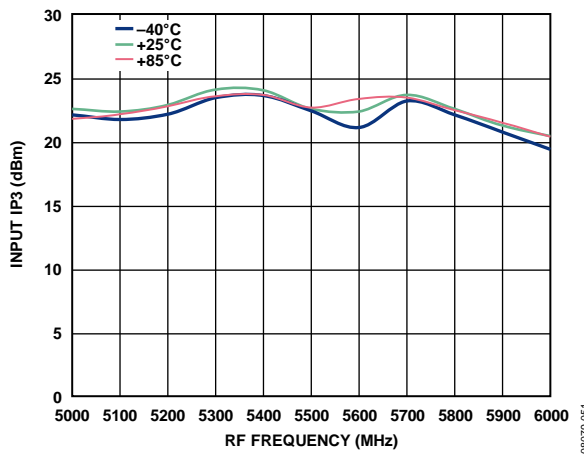

Figure 51. Input IP3 vs. RF Frequency

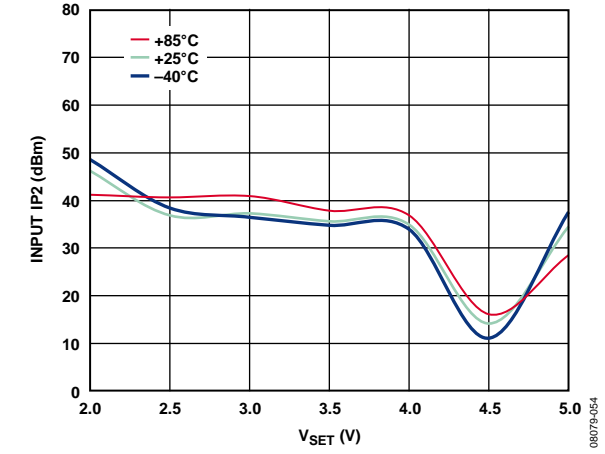

Figure 54. Input IP2 vs. V_{SET}

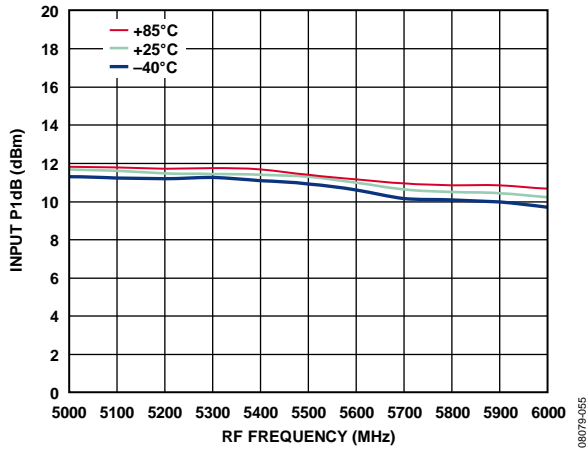

Figure 55. Input P1dB vs. RF Frequency

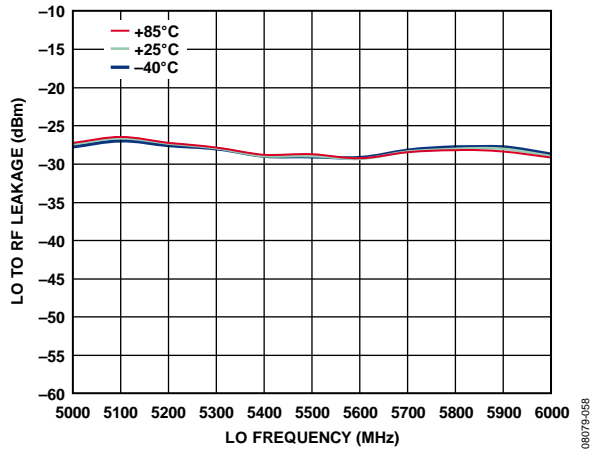

Figure 58. LO to RF Leakage vs. LO Frequency

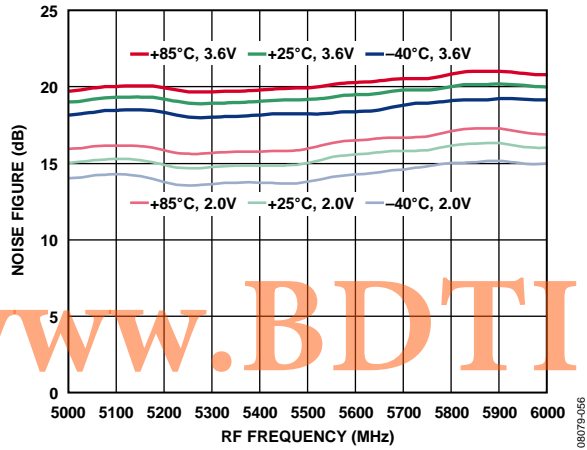

Figure 56. Noise Figure vs. RF Frequency, $V_{SET} = 3.6V$

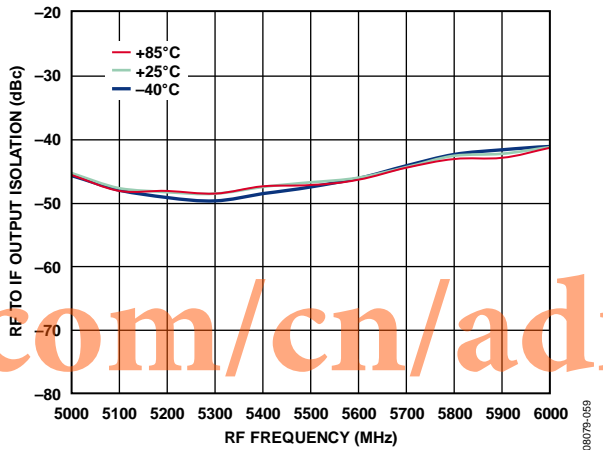

Figure 59. RF to IF Output Isolation vs. RF Frequency

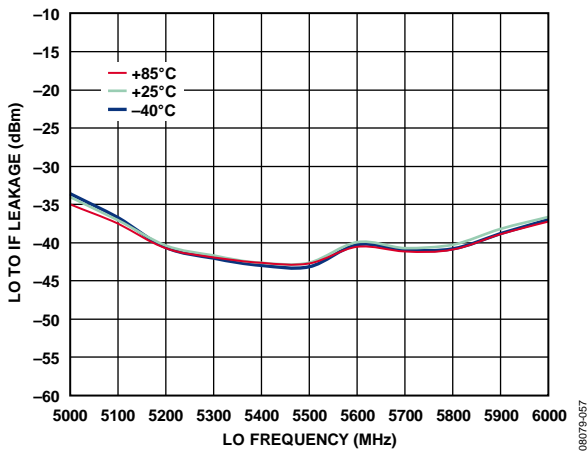

Figure 57. LO to IF Leakage vs. LO Frequency

UPCONVERTER MODE WITH A 900 MHZ OUTPUT MATCH

$V_S = 5\text{ V}$, $T_A = 25^\circ\text{C}$, $V_{SET} = 3.6\text{ V}$, $R_F = 153\text{ MHz}$, as measured using a typical circuit schematic with low-side local oscillator (LO), unless otherwise noted. Insertion loss of input and output baluns (TC1-1-13M+, TC4-14) is included in the gain measurement.

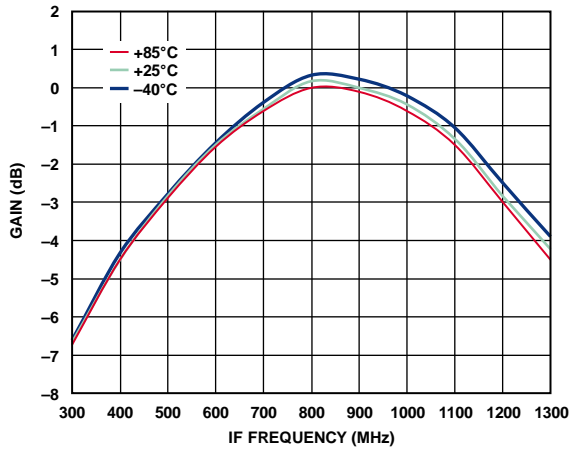

Figure 60. Power Conversion Gain vs. IF Frequency

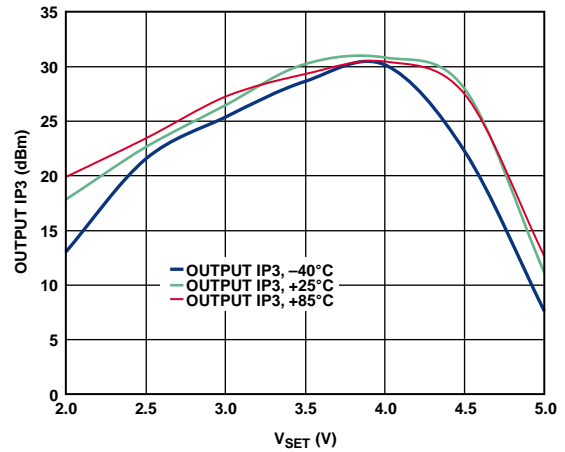

Figure 63. Output IP3 vs. V_{SET}

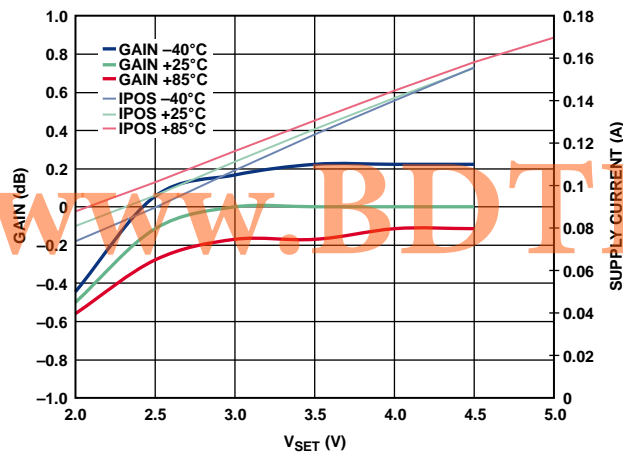

Figure 61. Power Conversion Gain and IPOS vs. V_{SET}

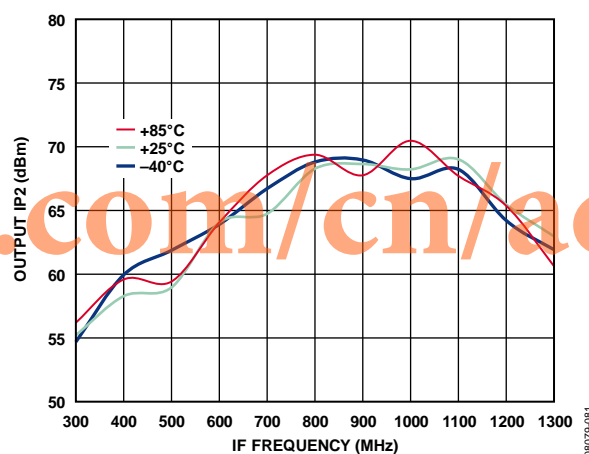

Figure 64. Output IP2 vs. IF Frequency

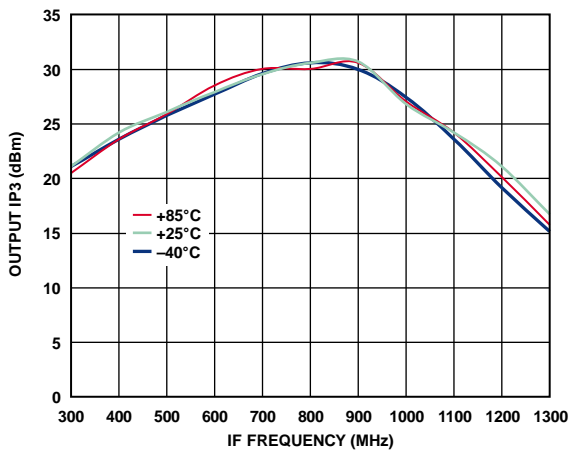

Figure 62. Output IP3 vs. IF Frequency

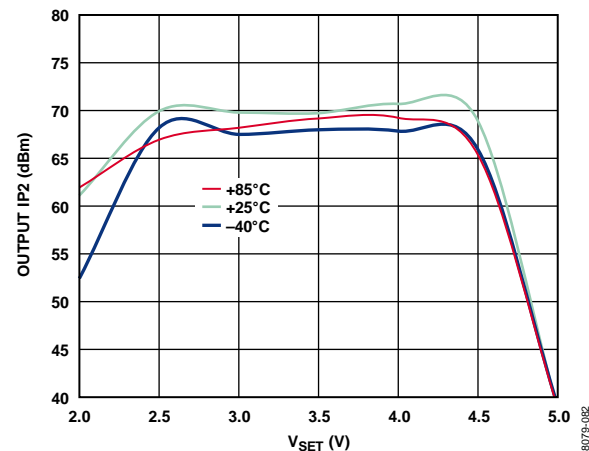

Figure 65. Output IP2 vs. V_{SET}

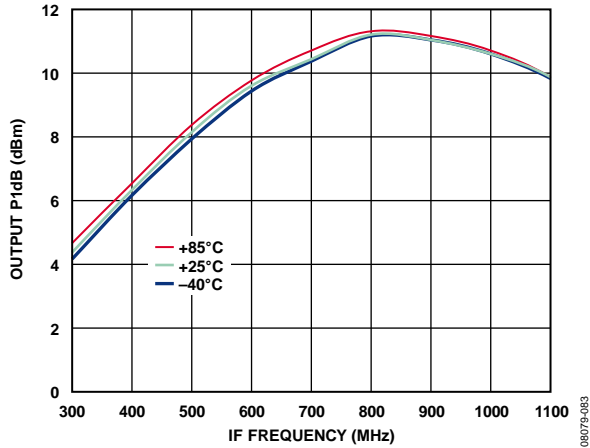

Figure 66. Output P1dB vs. IF Frequency

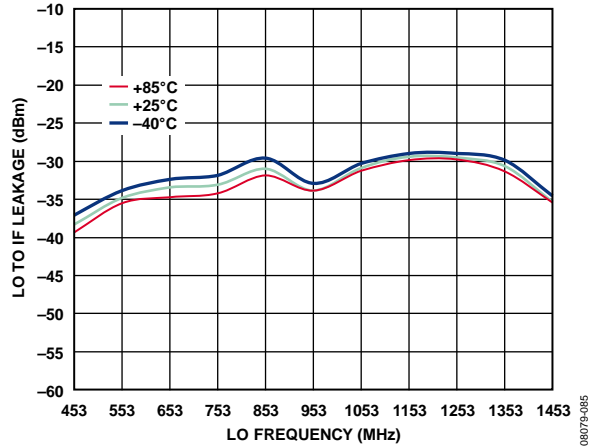

Figure 68. LO to IF Leakage vs. LO Frequency

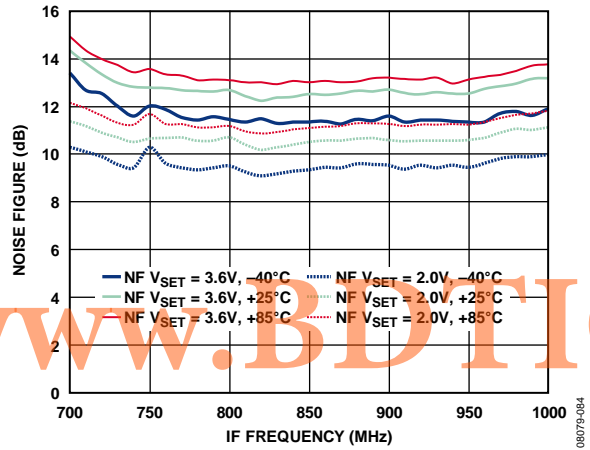

Figure 67. Noise Figure vs. IF Frequency, $F_{LO} = 650$ MHz

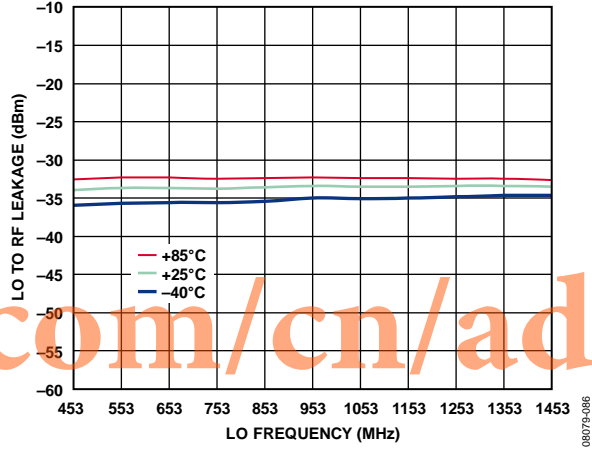

Figure 69. LO to RF Leakage vs. LO Frequency

UPCONVERTER MODE WITH A 2.1 GHZ OUTPUT MATCH

$V_S = 5\text{ V}$, $T_A = 25^\circ\text{C}$, $V_{SET} = 4\text{ V}$, $R_F = 170\text{ MHz}$, as measured using a typical circuit schematic with low-side local oscillator (LO), unless otherwise noted. Insertion loss of input and output baluns (TC1-1-13M+, 1850BL15B200) is included in the gain measurement.

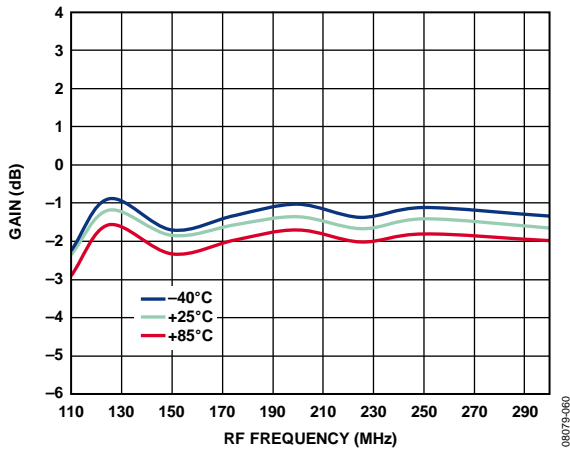

Figure 70. Power Conversion Gain vs. RF Frequency

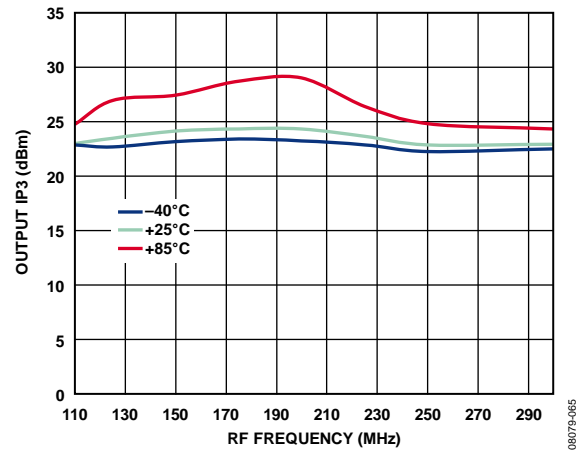

Figure 73. Output IP3 vs. RF Frequency

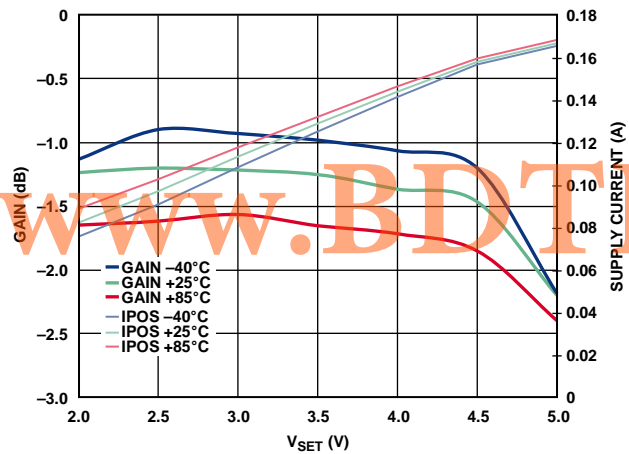

Figure 71. Power Conversion Gain and IPOS vs. V_{SET}

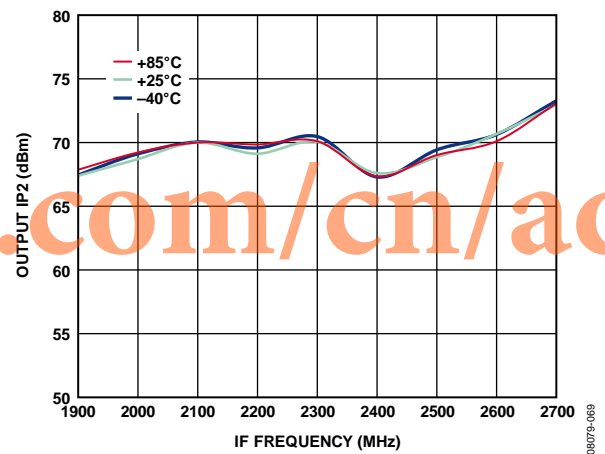

Figure 74. Output IP2 vs. IF Frequency

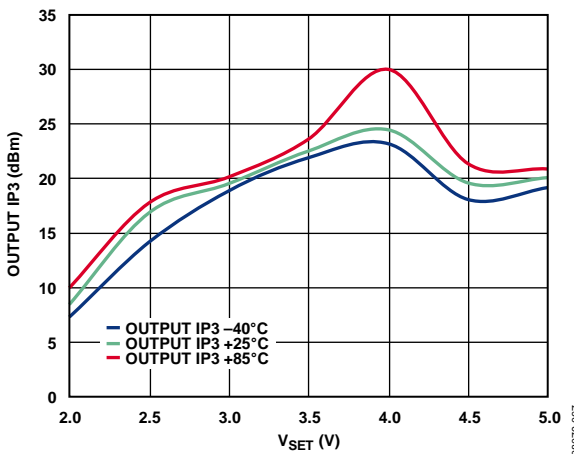

Figure 72. Output IP3 vs. V_{SET}

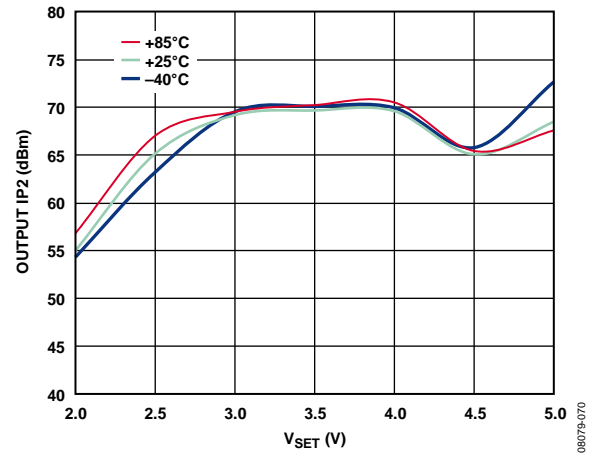

Figure 75. Output IP2 vs. V_{SET}

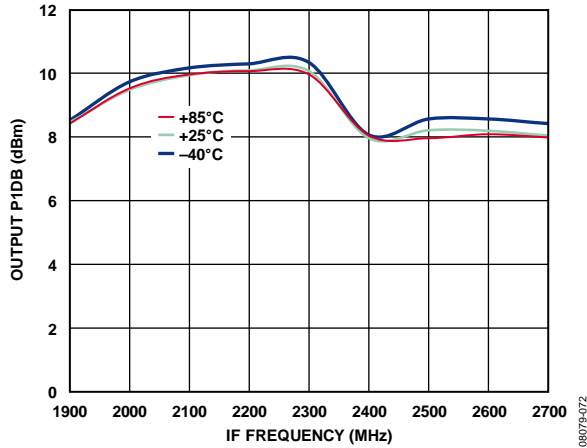

Figure 76. Output P1dB vs. IF Frequency

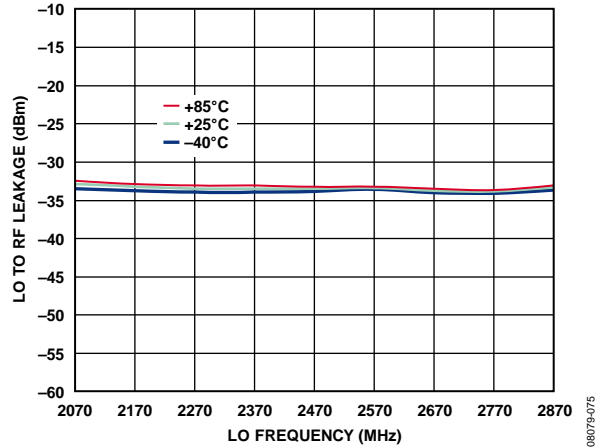

Figure 79. LO to RF Leakage vs. LO Frequency

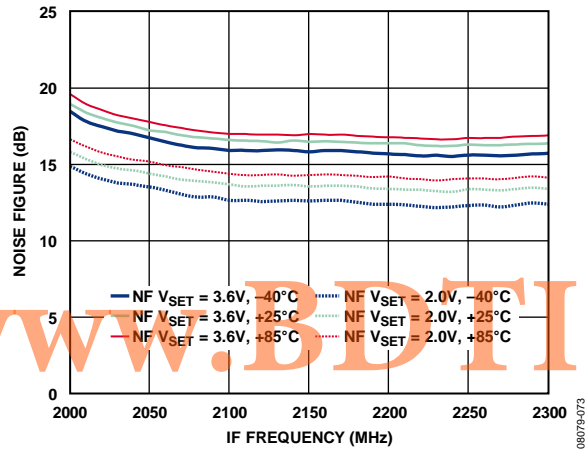

Figure 77. Noise Figure vs. IF Frequency, $F_{LO} = 1950$ MHz

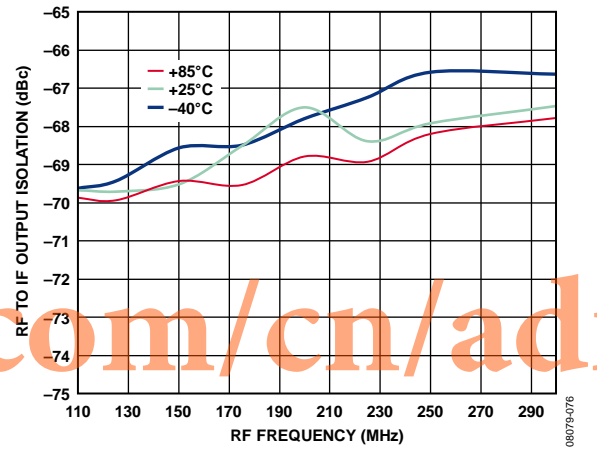

Figure 80. RF to IF Output Isolation vs. RF Frequency

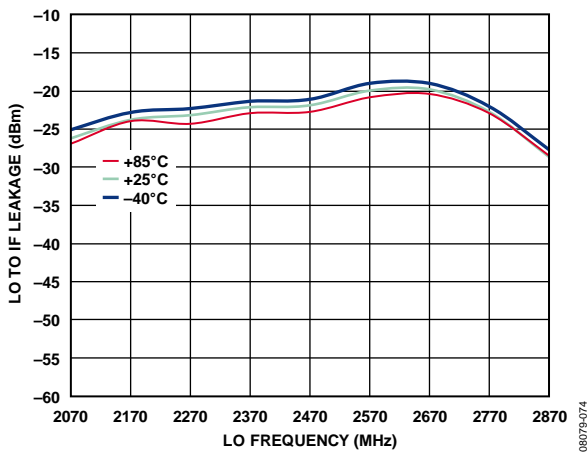

Figure 78. LO to IF Leakage vs. LO Frequency

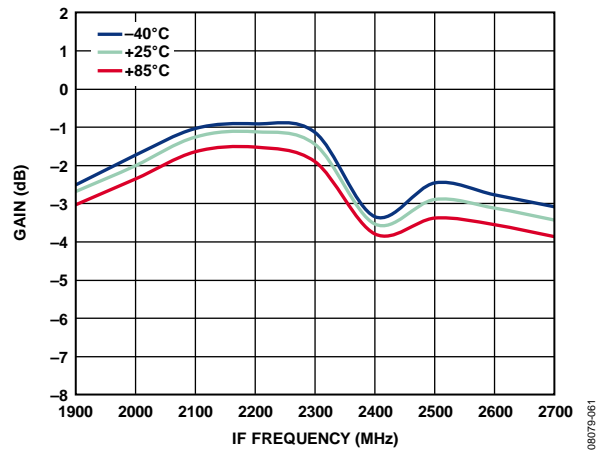

Figure 81. Power Conversion Gain vs. IF Frequency

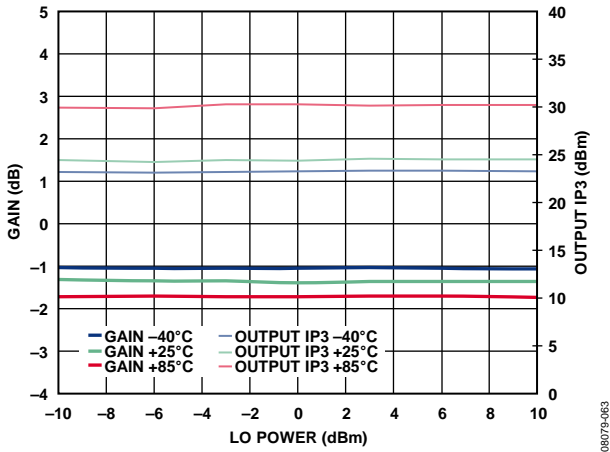

Figure 82. Power Conversion Gain and Output IP3 vs. LO Power

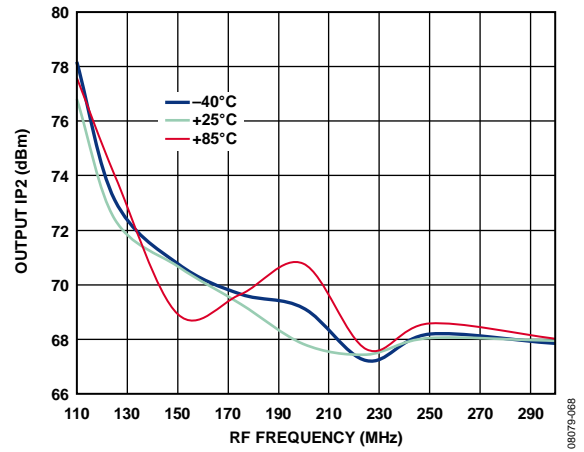

Figure 85. Output IP2 vs. RF Frequency

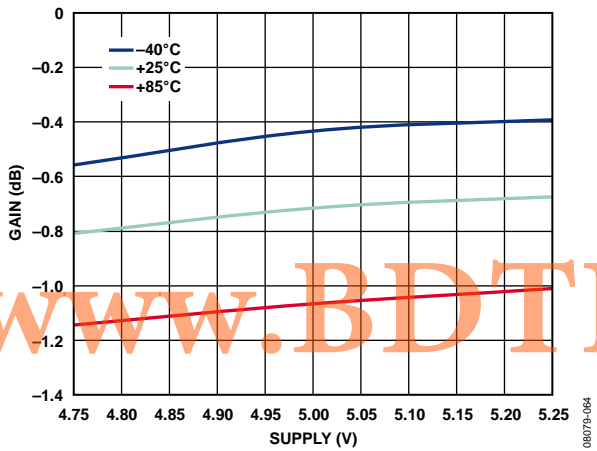

Figure 83. Power Conversion Gain vs. Supply

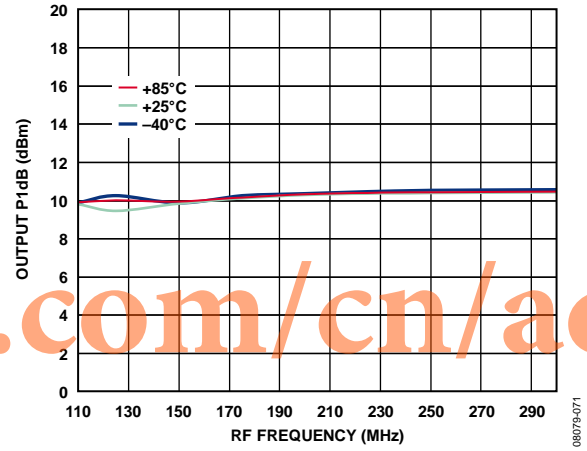

Figure 86. Output P1dB vs. RF Frequency

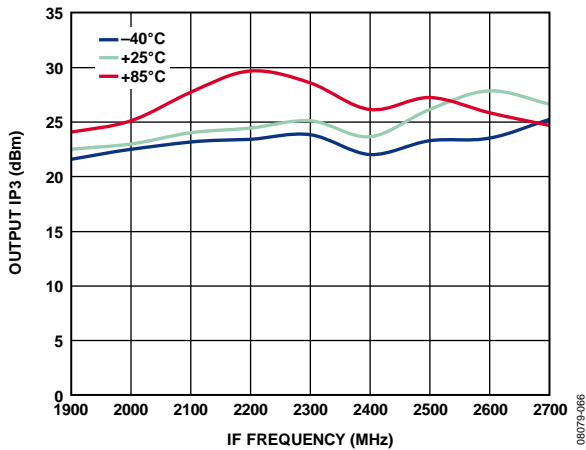

Figure 84. Output IP3 vs. IF Frequency

SPUR PERFORMANCE

All spur tables are $(N \times f_{RF}) - (M \times f_{LO})$ and were measured using the standard evaluation board (see the Evaluation Board section). Mixer spurious products are measured in decibels relative to the carrier (dBc) from the IF output power level. Data was measured for frequencies less than 6 GHz only. The typical noise floor of the measurement system is -100 dBm.

900 MHz Downconvert Performance

$V_S = 5$ V, $V_{SET} = 3.8$ V, $T_A = 25^\circ\text{C}$, RF power = 0 dBm, LO power = 0 dBm, $f_{RF} = 900$ MHz, $f_{LO} = 703$ MHz, $Z_0 = 50 \Omega$.

		M														
		0	1	2	3	4	5	6	7	8	9	10	11	12	13	14
N	0		-33.1	-23.3	-45.8	-23.6	-45.9	-30.7	-55.4	-41.5						
	1	-48.8	0.0	-51.5	-19.0	-65.1	-29.6	-78.0	-50.3	-74.4	-57.7					
	2	-35.9	-74.9	-67.5	-66.1	-73.5	-80.5	-65.0	-89.8	-71.3	-88.5	-86.8	-98.8			
	3	-68.8	-64.8	-94.3	-65.9	-86.3	-70.2	-76.3	-70.6	-74.5	-81.4	≤ -100	-99.6	≤ -100		
	4	-47.5	-80.7	-78.0	-78.4	-95.1	-73.5	-89.4	-87.3	≤ -100	-92.7	-99.5	-99.4	≤ -100	≤ -100	
	5	-95.6	-74.7	-89.8	-70.7	-84.8	-90.7	-86.7	-86.4	-83.1	-73.7	-78.7	-80.7	-91.1	≤ -100	≤ -100
	6	-85.7	-96.4	-83.1	-98.5	-83.3	-96.7	≤ -100	-89.4	-99.6	-96.1	-96.1	-95.4	-95.5	≤ -100	≤ -100
	7		≤ -100	≤ -100	-95.9	≤ -100	-97.2	-83.1	-84.1	≤ -100	≤ -100	-99.7	-87.9	-88.8	-85.7	≤ -100
	8			≤ -100	≤ -100	-99.0	-99.8	-86.0	≤ -100	≤ -100	≤ -100	≤ -100	≤ -100	≤ -100	≤ -100	≤ -100
	9				≤ -100	≤ -100	≤ -100	-90.9	-88.4	-83.5	-87.6	≤ -100	≤ -100	≤ -100	≤ -100	≤ -100
	10						≤ -100	≤ -100	≤ -100	-97.9	-95.5	-99.0	≤ -100	≤ -100	≤ -100	≤ -100
	11							≤ -100	≤ -100	-92.6	-87.4	-88.2	-92.3	-99.3	≤ -100	≤ -100
	12								≤ -100	≤ -100	≤ -100	≤ -100	≤ -100	≤ -100	≤ -100	≤ -100
	13										≤ -100	≤ -100	-95.1	-96.5	-90.4	≤ -100
	14											≤ -100	≤ -100	≤ -100	≤ -100	≤ -100
15												≤ -100	≤ -100	≤ -100	≤ -100	

1900 MHz Downconvert Performance

$V_S = 5$ V, $V_{SET} = 3.8$ V, $T_A = 25^\circ\text{C}$, RF power = 0 dBm, LO power = 0 dBm, $f_{RF} = 1900$ MHz, $f_{LO} = 1703$ MHz, $Z_0 = 50 \Omega$.

		M														
		0	1	2	3	4	5	6	7	8	9	10	11	12	13	14
N	0		-31.4	-17.1	-51.4											
	1	-40.4	0.0	-53.6	-38.5	-71.0										
	2	-38.4	-66.0	-52.9	-68.1	-64.2	-86.8									
	3	≤ -100	-66.2	-73.2	-72.6	-79.9	-65.2	-92.8								
	4		≤ -100	-89.4	-86.4	-94.6	-87.4	-81.5	≤ -100							
	5				-83.7	-66.2	-79.3	-89.0	-75.2	≤ -100	≤ -100					
	6					≤ -100	-86.4	≤ -100	-99.0	-87.7	≤ -100	≤ -100				
	7						≤ -100	-92.4	-92.7	≤ -100	-98.4	≤ -100	≤ -100			
	8							≤ -100	≤ -100	-97.5	≤ -100	-95.4	≤ -100	≤ -100		
	9								≤ -100	≤ -100	≤ -100	≤ -100	≤ -100	≤ -100	≤ -100	
	10									≤ -100	-97.2	-95.6	≤ -100	≤ -100	≤ -100	≤ -100
	11										≤ -100	≤ -100	≤ -100	≤ -100	≤ -100	≤ -100
	12											≤ -100	≤ -100	≤ -100	≤ -100	≤ -100
	13												≤ -100	≤ -100	≤ -100	≤ -100
	14														≤ -100	≤ -100
15															≤ -100	

2600 MHz Downconvert Performance

$V_S = 5\text{ V}$, $V_{SET} = 3.8\text{ V}$, $T_A = 25^\circ\text{C}$, RF power = 0 dBm, LO power = 0 dBm, $f_{RF} = 2600\text{ MHz}$, $f_{LO} = 2350\text{ MHz}$, $Z_0 = 50\ \Omega$.

		M															
		0	1	2	3	4	5	6	7	8	9	10	11	12	13	14	15
N	0		-31.5	-30.3													
	1	-40.3	0.0	-55.8	-33.8												
	2	-71.7	-73.6	-50.6	-70.4	-64.8											
	3		-83.9	-66.5	-59.8	-71.3	-84.7										
	4			-94.7	-77.6	-92.6	-83.8	-90.6									
	5				-91.4	-71.1	-89.7	-98.2	-96.3	<100							
	6						-83.1	-90.3	-92.9	-97.3	<100						
	7							<100	-91.4	<100	<100	<100					
	8								<100	-96.6	<100	-91.8	<100				
	9									<100	-97.9	<100	-98.5	<100			
	10										<100	-93.5	<100	-98.8	<100		
	11											<100	<100	<100	<100	<100	
	12												<100	<100	<100	<100	<100
	13													<100	<100	<100	<100
	14														<100	<100	<100
	15																<100

3800 MHz Downconvert Performance

$V_S = 5\text{ V}$, $V_{SET} = 3.8\text{ V}$, $T_A = 25^\circ\text{C}$, RF power = 0 dBm, LO power = 0 dBm, $f_{RF} = 3800\text{ MHz}$, $f_{LO} = 3500\text{ MHz}$, $Z_0 = 50\ \Omega$.

		M															
		0	1	2	3	4	5	6	7	8	9	10	11	12	13	14	15
N	0		-27.3														
	1	-33.7	0.0	-54.9													
	2		-78.5	-47.1	-66.4												
	3			-63.6	-57.8	-81.4											
	4				-89.6	-77.2	-72.2	-99.2									
	5					<100	-88.0	-80.4	<100								
	6						<100	-90.0	-90.4	<100							
	7							<100	-79.1	<100	<100						
	8								<100	-85.2	<100	<100					
	9									<100	<100	<100					
	10										<100	-95.9	<100				
	11											<100	<100	<100			
	12												<100	<100	<100		
	13													<100	<100	<100	
	14														<100	<100	
	15															<100	<100

5800 MHz Downconvert Performance

$V_s = 5\text{ V}$, $V_{SET} = 3.8\text{ V}$, $T_A = 25^\circ\text{C}$, RF power = 0 dBm, LO power = 0 dBm, $f_{RF} = 5800\text{ MHz}$, $f_{LO} = 5600\text{ MHz}$, $Z_0 = 50\ \Omega$.

		M															
		0	1	2	3	4	5	6	7	8	9	10	11	12	13	14	15
N	0		-44.9														
	1	-43.9	0.0	-68.9													
	2			-44.0	-78.0												
	3				-47.0	-93.3											
	4					-60.6	-87.8										
	5						-62.7	-85.7									
	6							-70.2	-97.8								
	7								-79.5	-85.3							
	8									-71.2	<100						
	9										<100	<100					
	10											<100	<100				
	11												<100	<100			
	12													<100	<100		
	13														<100.3	<100	
	14															-95.6	-96.0
15																<100	

806 MHz Upconvert Performance

$V_s = 5\text{ V}$, $V_{SET} = 3.8\text{ V}$, $T_A = 25^\circ\text{C}$, RF power = 0 dBm, LO power = 0 dBm, $f_{RF} = 140\text{ MHz}$, $f_{LO} = 946\text{ MHz}$, $Z_0 = 50\ \Omega$.

		M															
		0	1	2	3	4	5	6	7	8	9	10	11	12	13	14	15
N	0		-35.2	-22.9	-42.8	-28.4	-59.1	-40.1									
	1	-66.0	0.0	-67.7	-14.0	-70.0	-37.1	-74.3									
	2	-67.8	-66.0	-62.9	-65.3	-61.1	-84.1	-81.2									
	3	-99.2	-66.2	-92.2	-69.2	-84.9	-84.3	<100									
	4	-77.1	-97.2	-85.1	-97.8	-82.0	<100	<100									
	5	-88.7	<100	-88.5	-92.9	-96.4	-93.6	<100	<100								
	6	-86.1	<100	-92.7	-95.8	-87.5	-99.5	<100	<100								
	7	-90.2	<100	<100	-84.6	<100	-88.0	<100	<100								
	8	-73.8	<100	-94.8	-96.4	-93.4	-99.6	<100	<100								
	9	-91.1	-96.3	<100	-91.5	-100.3	-93.3	<100	<100								
	10	-66.2	<100	<100	<100	-88.3	-100.0	<100	<100								
	11	-87.7	-93.6	<100	-95.9	<100	<100	<100	<100								
	12	-69.5	-89.1	<100	<100	-93.8	<100	<100	<100	<100							
	13	-85.2	-95.7	<100	<100	-97.7	-90.5	-96.0	<100	<100							
	14	-65.2	-85.9	<100	-93.1	-94.5	<100	<100	<100	<100							
15	-91.3	-93.5	<100	-96.6	-98.7	-93.5	-99.6	<100	<100								

2210 MHz Upconvert Performance

$V_s = 5\text{ V}$, $V_{SET} = 4.0\text{ V}$, $T_A = 25^\circ\text{C}$, RF power = 0 dBm, LO power = 0 dBm, $f_{RF} = 140\text{ MHz}$, $f_{LO} = 2350\text{ MHz}$, $Z_0 = 50\ \Omega$.

		M															
		0	1	2	3	4	5	6	7	8	9	10	11	12	13	14	15
N	0		-21.0	-12.8													
	1	-81.3	0.0	-70.1													
	2	-66.0	-58.8	-51.5													
	3	<100	-56.7	-78.2													
	4	-74.4	-86.3	-76.5													
	5	<100	-75.3	-88.0													
	6	-90.9	-81.4	-91.5													
	7	-96.4	-71.2	-85.9													
	8	-75.8	-89.7	-86.3	<100												
	9	-92.9	-86.2	-92.2	<100												
	10	-66.5	<100	-97.5	<100												
	11	-83.7	-98.4	-97.9	<100												
	12	-64.8	<100	-93.1	<100												
	13	-81.2	<100	<100	<100												
	14	-64.5	<100	-91.0	<100												
	15	-85.3	<100	<100	-95.4												

www.BDTIC.com/cn/adi

CIRCUIT DESCRIPTION

The **ADL5801** includes a double-balanced active mixer with a 50 Ω input impedance and 250 Ω output impedance. In addition, the **ADL5801** integrates a local oscillator (LO) amplifier and an RF power detector that can be used to optimize the mixer dynamic range. The RF and LO are differential, providing maximum usable bandwidth at the input and output ports. The LO also operates with a 50 Ω input impedance and can, optionally, be operated differentially or single ended. The input, output, and LO ports can be operated over an exceptionally wide frequency range. The **ADL5801** can be configured as a downconvert mixer or as an upconvert mixer.

The **ADL5801** can be divided into the following sections: the LO amplifier and splitter, the RF voltage-to-current (V-to-I) converter, the mixer core, the output loads, the RF detector, and the bias circuit. A simplified block diagram of the device is shown in Figure 87. The LO block generates a pair of differential LO signals to drive two mixer cores. The RF input power is converted into RF currents by the V-to-I converter that then feed into the two-mixer core. The internal differential load of the mixer provides a wideband 250 Ω output impedance from the mixer. Reference currents to each section are generated by the bias circuit, which can be enabled or disabled using the ENBL pin. A detailed description of each section of the **ADL5801** follows.

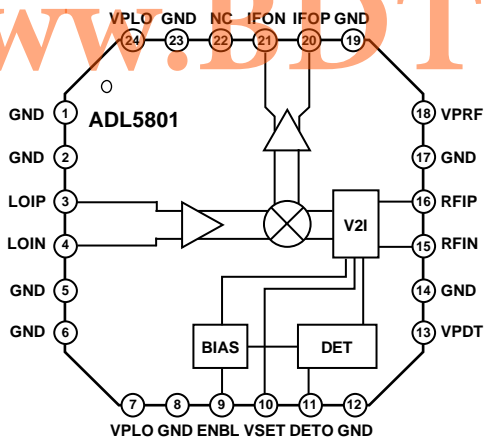

Figure 87. Block Diagram

LO AMPLIFIER AND SPLITTER

The LO input is conditioned by a series of amplifiers to provide a well controlled and limited LO swing to the mixer core, resulting in excellent input IP3. The LO input is amplified using a broadband low noise amplifier (LNA) and is then followed by LO limiting amplifiers. The LNA input impedance is nominally 50 Ω . The LO circuit exhibits low additive noise, resulting in an excellent mixer noise figure and output noise under RF blocking. For optimal performance, the LO inputs should be driven differentially but at lower frequencies; single-ended drive is acceptable.

RF VOLTAGE-TO-CURRENT (V-TO-I) CONVERTER

The differential RF input signal is applied to a V-to-I converter that converts the differential input voltage to output currents. The V-to-I converter provides a 50 Ω input impedance. The V-to-I section bias current can be adjusted up or down using the VSET pin. Adjusting the current up improves IP3 and P1dB input but degrades the SSB noise figure. Adjusting the current down improves the SSB noise figure but degrades IP3 and P1dB input. Conversion gain remains nearly constant over a wide range of VSET pin settings, allowing the part to be adjusted dynamically without affecting conversion gain.

MIXER CORE

The **ADL5801** has a double-balanced mixer that uses high performance SiGe NPN transistors. This mixer is based on the Gilbert cell design of four cross-connected transistors.

MIXER OUTPUT LOAD

The mixer load uses a pair of 125 Ω resistors connected to the positive supply. This provides a 250 Ω differential output resistance. The mixer output should be pulled to the positive supply externally using a pair of RF chokes or using an output transformer with the center tap connected to the positive supply. It is possible to exclude these components when the mixer core current is low, but both P1dB input and IP3 input are then reduced.

The mixer load output can operate from direct current (dc) up to approximately 600 MHz into a 200 Ω load. For upconversion applications, the mixer load can be matched using off-chip matching components. Transmit operation up to 3 GHz is possible. See the Applications Information section for matching circuit details.

RF DETECTOR

An RF power detector is buffered from the V-to-I converter section. This detector has a power response range from approximately -25 dBm up to 0 dBm and provides a current output. The output current is designed to be connected to the VSET pin to boost the mixer core current when large RF signals are present at the mixer input. An external capacitor can be used to adjust the response time of this function. If not used, the DETO pin can be left open or connected to ground.

The detector was characterized under the conditions specified in the Downconverter Mode with a Broadband Balun section. Pin 11 (DETO) was connected to Pin 10 (VSET), and the voltage on these pins was plotted vs. the RF input power level over temperature and a number of devices.

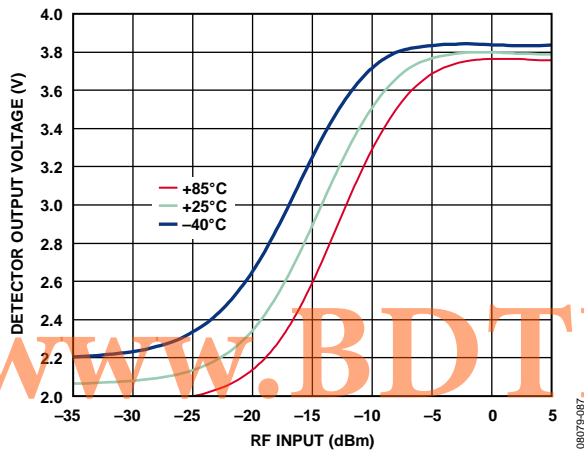

Figure 88. Detector Output Voltage vs. RF Input

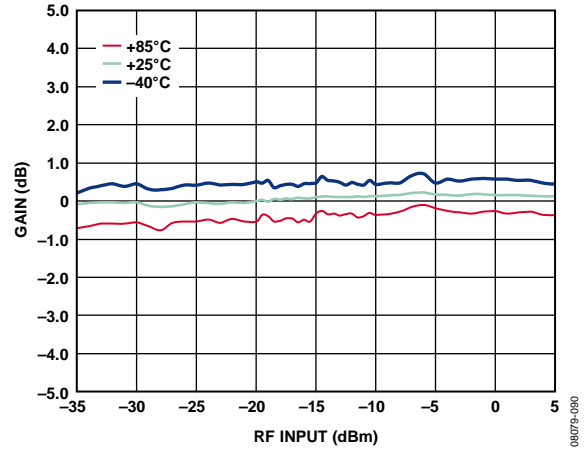

Figure 90. Power Conversion Gain vs. RF Input

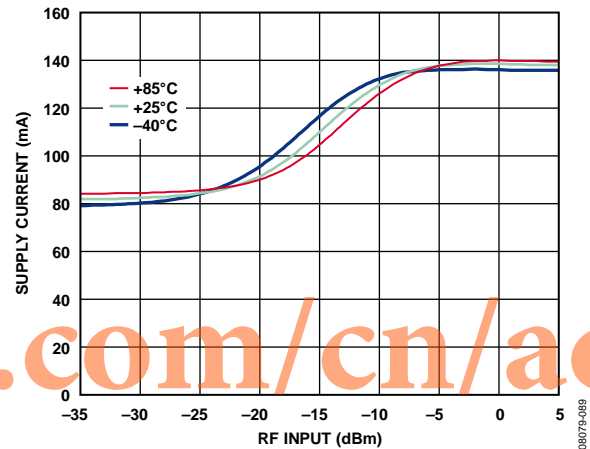

Figure 91. Supply Current vs. RF Input

The input IP3, gain and supply current were also recorded under these conditions. The result can be seen in Figure 89 through Figure 91.

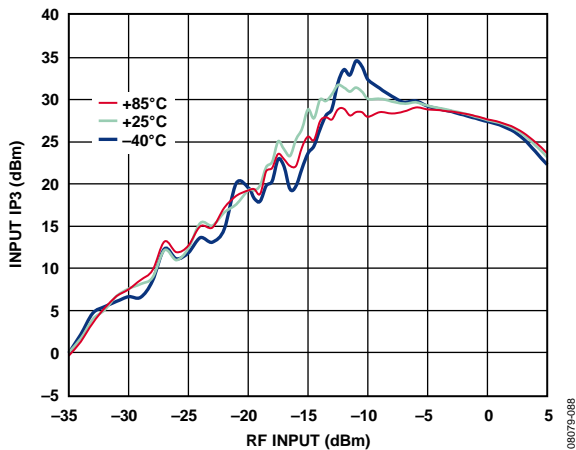

Figure 89. Input IP3 vs. RF Input

BIAS CIRCUIT

A band gap reference circuit generates the reference currents used by mixers. The bias circuit and the internal detector can be enabled and disabled using the ENBL pin. Pulling the ENBL pin high shuts off the bias circuit and the internal detector. However, the ENBL pin does not alter the current in the LO section and, therefore, does not provide a true power-down feature. When the ENBL pin is pulled high, the device can be operated by applying an external voltage to the VSET pin or by connecting a resistor from the VSET pin to the positive supply. Internally, the VSET pin features a series resistance and diode to ground; therefore, a simple voltage divider driving the pin is not sufficient. Table 4 lists some typical values for this resistor and the resulting VSET value and supply current when the ENBL pin is set high. Use Table 4 to select the appropriate value of R10 (see Figure 110) to achieve the desired mixer bias level. In this mode of operation, the VSET pin must not be left floating, and placeholders R7 and R9 must remain open.

Table 4. Suggested Values of R10 (When ENBL Pin is High)

R10 (Ω)	VSET (V)	I _{POS} (mA) ¹
226	4.14	140
488	4.00	126
562	3.90	123
568	3.89	123
659	3.78	120
665	3.77	120
694	3.74	119
760	3.67	116
768	3.66	116
1000	3.44	109
1100	3.36	107
1150	3.33	106
1200	3.29	105
1300	3.22	102
1400	3.16	100
1500	3.10	99
1600	3.05	97
1700	3.00	95
1800	2.95	94
1900	2.91	92
2000	2.87	91
2300	2.76	87
5900	2.18	68

Table 5. Suggested Values of R10 (When ENBL Pin is Low)

R10 (Ω)	VSET (V)	I _{POS} (mA) ¹
226	4.5	160
562	4.01	146
568	4	145
659	3.9	142
665	3.89	142
694	3.85	142
760	3.8	139
768	3.79	139
1000	3.6	133
1100	3.53	131
1150	3.5	130
1200	3.47	129
1300	3.4	127
1400	3.35	126
1500	3.3	124
1600	3.26	122
1700	3.21	121
1800	3.17	120
1900	3.14	119
2000	3.1	118
2300	3	114
5900	2.5	98
Open	2.03	82

¹ I_{POS} is the mixer supply current.

If the ENBL pin is pulled low, the bias circuit and internal detector of the device are enabled. In this mode, the device can be operated by applying an external voltage to the VSET pin or by connecting a resistor from the VSET pin to the positive supply. Table 5 lists some typical values for this resistor and the resulting VSET value and supply current when the ENBL pin is set low. Use Table 5 to select the appropriate value of R10 (see Figure 110) to achieve the desired mixer bias level. In this mode of operation, R7 and R9 must remain open.

Optionally, the VSET pin can be connected to the DETO pin to provide dynamic mixer bias control using the internal detector.

Figure 92 is a comparison of the input IP3 performance vs. RF input power levels at 2 GHz, when the ENBL pin is pulled high and low. Pulling ENBL high results in improved linearity across input power levels, while pulling ENBL low results in enhanced IP3 performance at higher power levels. The device also exhibits improved spur performance when the ENBL pin is pulled high. Figure 95 is a comparison of the 4LO-5RF and 6LO-7RF spurs vs. RF input power levels at 900 MHz with ENBL high and low.

¹ I_{POS} is the mixer supply current.

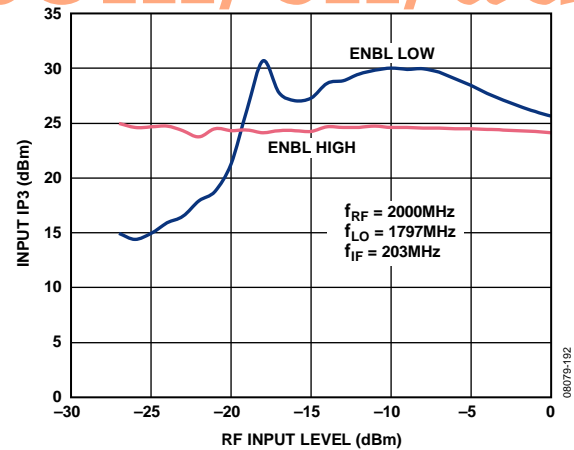

Figure 92. Input IP3 vs. RF Input Level at 2 GHz, VSET = 3.8 V, with ENBL High and Low

Figure 93 is a plot of the input IP3 vs. RF input power levels for varying VSET levels at 2 GHz, when the ENBL pin is pulled high. The device exhibits the best linearity at a VSET level of 4.0 V in this mode of operation. As mentioned previously, the VSET level can be set using an external voltage or by placing a resistor from the VSET pin to the positive supply. Figure 94 is a plot of the input IP3 vs. RF input power levels for a VSET level of 4.0 V, when the ENBL is pulled high for varying temperature and frequency conditions. The device is well behaved across varying frequency levels and exhibits excellent temperature sensitivity.

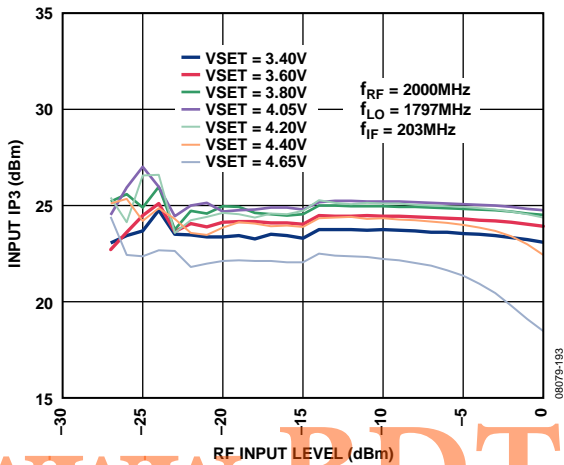

Figure 93. Input IP3 vs. RF Input Level at 2 GHz for Varying VSET levels, ENBL High

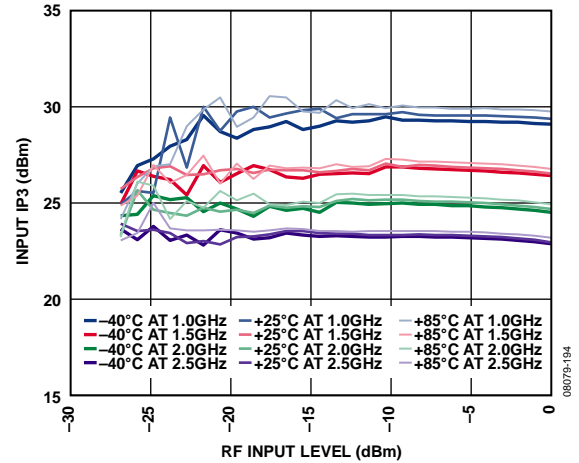

Figure 94. Input IP3 vs. RF Input Level for Across Varying Frequency and Temperature Conditions, VSET = 4.0 V, ENBL High

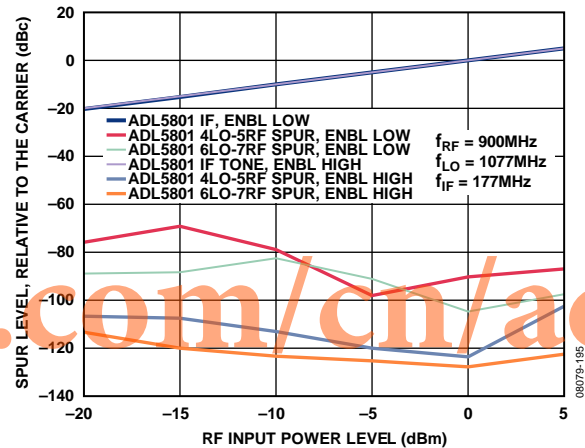

Figure 95. 4LO-5RF and 6LO-7RF Spurs vs. RF Input Level at 900 MHz, with ENBL High and Low

APPLICATIONS INFORMATION

BASIC CONNECTIONS

The ADL5801 is designed to translate between radio frequencies (RF) and intermediate frequencies (IF). For both upconversion and downconversion applications, RFIP (Pin 16) and RFIN (Pin 15) must be configured as the input interfaces. IFOP (Pin 20) and IFON (Pin 21) must be configured as the output interfaces. Individual bypass capacitors are needed in close proximity to each supply pin (Pin 7, Pin 13, Pin 18, and Pin 24), the VSET control pin (Pin 10), and the DETO detector output pin (Pin 11). When the on-chip detector is chosen to form a closed loop, automatically controlling the VSET pin, R7 can be populated with a 0 Ω resistor. Alternatively, simply use a jumper between the VSET and DETO test points for evaluation. Figure 96 illustrates the basic connections for ADL5801 operation.

RF AND LO PORTS

The RF and LO input ports are designed for a differential input impedance of approximately 50 Ω. Figure 97 and Figure 98 illustrate the RF and LO interfaces, respectively. It is recommended that each of the RF and LO differential ports be driven through a balun for optimum performance. It is also necessary to ac couple both RF and LO ports. Using proper value capacitors may help improve the input return loss over desired frequencies. Table 6 and Table 9 list the recommended components for various RF and LO frequency bands in upconvert and downconvert modes. The characterization data is available in the Typical Performance Characteristics section.

www.BDTIC.com/cn/adi

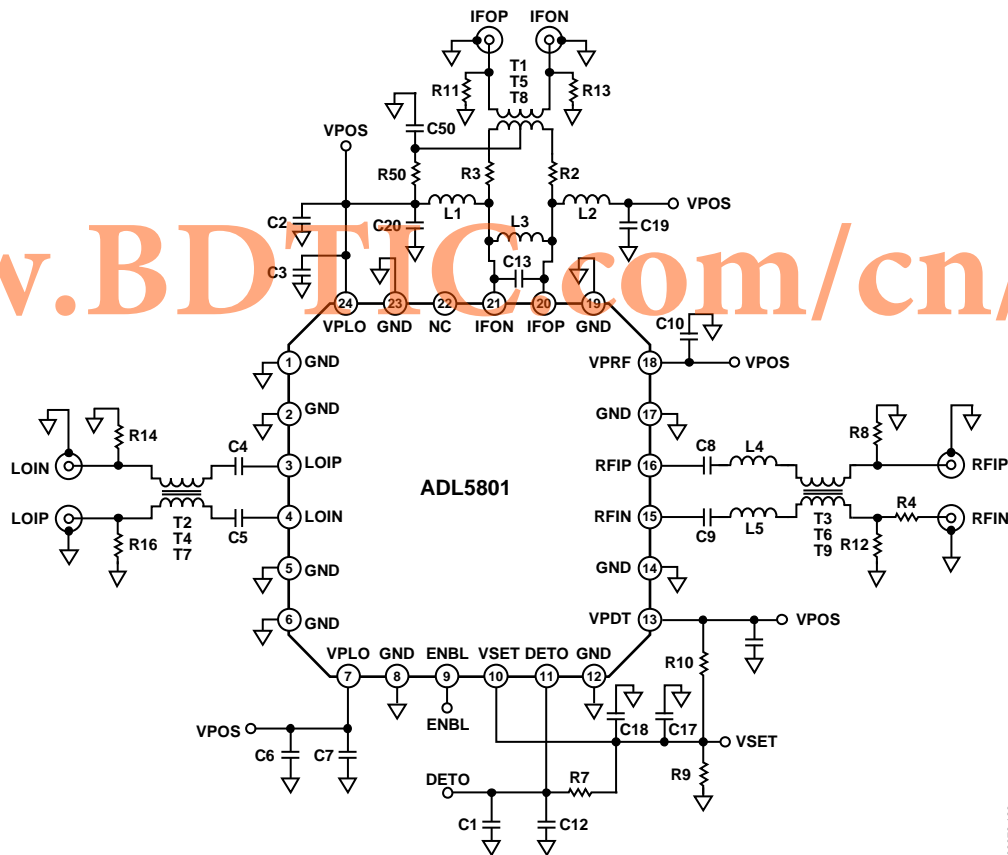

Figure 96. Basic Connections Schematic

080794-128

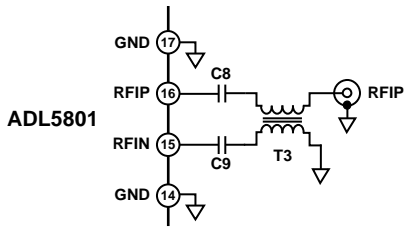

Figure 97. RF Interface

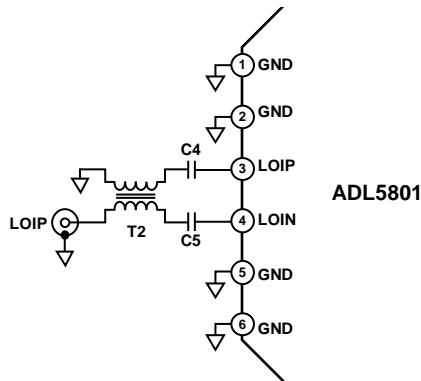

Figure 98. LO Interface

Table 6. Suggested Components for the RF and LO Interfaces in Downconvert Mode

RF and LO Frequency	T2, T3	C8, C9	C4, C5
10 MHz	Mini-Circuits TC1-1-13M+	1 nF	1 nF
900 MHz	Mini-Circuits TC1-1-13M+	5.6 pF	100 pF
1900 MHz	Mini-Circuits TC1-1-13M+	5.6 pF	100 pF
2500 MHz	Mini-Circuits TC1-1-43M+	2 pF	8 pF
3500 MHz	3600BL14M050	1.5 pF	1.5 pF
5500 MHz	5400BL14B050	3 pF	3 pF
10 MHz to 6000 MHz	Mini-Circuits TCM1-63AX+	1 nF	1 nF

Table 7. Suggested Components for the RF Interface in Upconvert Mode

RF Frequency	T3	C8, C9
153 MHz	TC1-1-13M+	470 pF

IF PORT

The IF port features an open-collector, differential output interface. It is necessary to bias the open collector outputs using one of the schemes presented in Figure 99 and Figure 100.

Figure 99 shows the use of center-tapped impedance transformers. The turns ratio of the transformer should be selected to provide the desired impedance transformation. In the case of a 50 Ω load impedance, a 4:1 impedance ratio transformer should be used to transform the 50 Ω load into a 200 Ω differential load at the IF output pins.

Figure 100 shows a differential IF interface where pull-up choke inductors are used to bias the open-collector outputs. The

shunting impedance of the choke inductors used to couple dc current into the mixer core should be large enough at the IF frequency of operation not to load down the output current before it reaches the intended load. Additionally, the dc current handling capability of the selected choke inductors must be at least 45 mA.

The self-resonant frequency of the selected choke inductors must be higher than the intended IF frequency. A variety of suitable choke inductors is commercially available from manufacturers such as Coilcraft® and Murata. An impedance transforming network may be required to transform the final load impedance to 200 Ω at the IF outputs.

Table 8 lists suggested components for the IF port in the upconvert and downconvert modes.

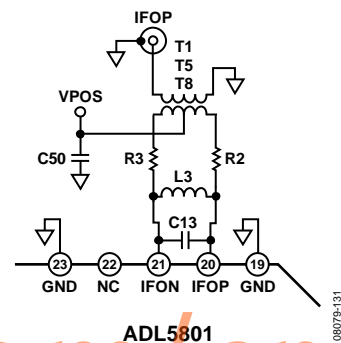

Figure 99. Biasing the IF Port Open-Collector Outputs Using a Center-Tapped Impedance Transformer

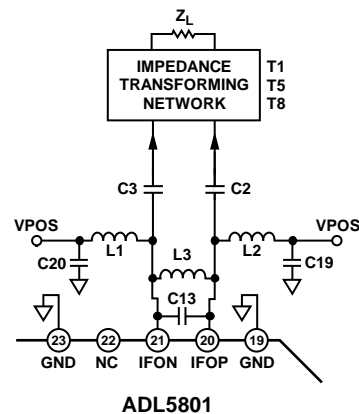

Figure 100. Biasing the IF Port Open-Collector Outputs Using Pull-Up Choke Inductors

Table 8. Suggested Components for the IF Port in Upconvert and Downconvert Modes

IF Frequency	Mode of Operation	T1	L3
0 MHz to 500 MHz	Downconvert	TC4-1W+	Open
900 MHz	Upconvert	TC4-14+	27 nH
2140 MHz	Upconvert	1850BL15B200	3.3 nH

DOWNCONVERTING TO LOW FREQUENCIES

For downconversion to lower frequencies, the device should be biased at the output with a resistor. The common-mode voltage at the IF output of the device should be 3.75 V to ensure optimal performance. Figure 101 provides a sample setup to downconvert a 900 MHz input signal down to 100 kHz. In the setup depicted in Figure 101, the output of the device is biased with 50 Ω resistors. In this mode of operation, the device exhibits 2.0 dB of conversion gain when a signal at 500 MHz was downconverted to a 100 kHz, 10 kHz or 1 kHz.

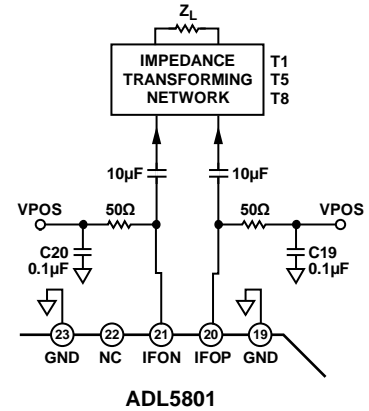

Figure 101. Resistive Bias Network to Downconvert Signals to Low Frequencies

www.BDTIC.com/cn/adi

BROADBAND OPERATION

The ADL5801 can support input frequencies from 10 MHz to 6 GHz. The device can be operated with a broadband balun such as the MiniCircuits TCM1-63AX+ for applications that need wideband frequency coverage. Figure 102 illustrates a sample setup configuration with the MiniCircuits TCM1-63AX+ balun populated on the RF and LO ports. This single setup solution provides the option to utilize the complete input frequency range of the device.

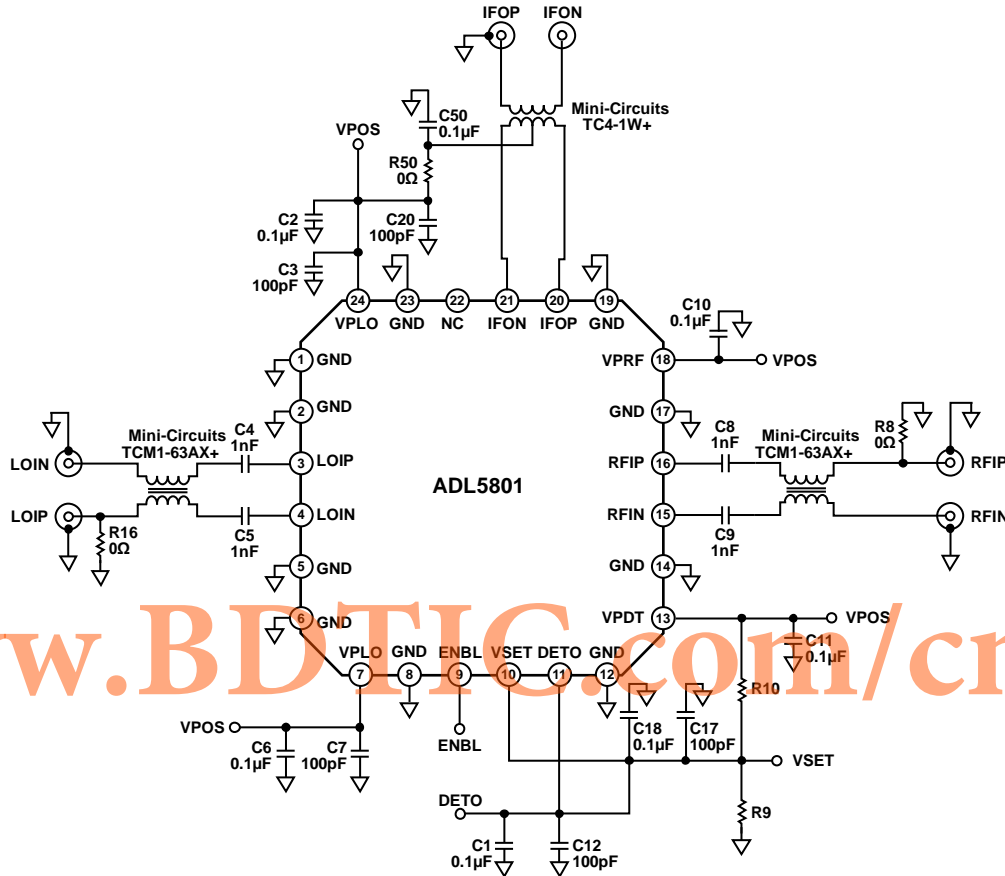
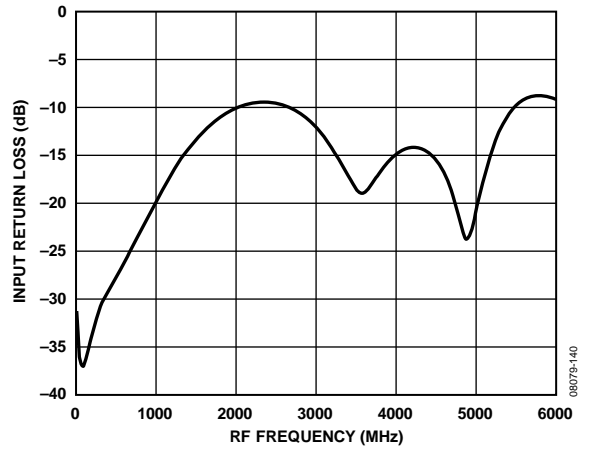
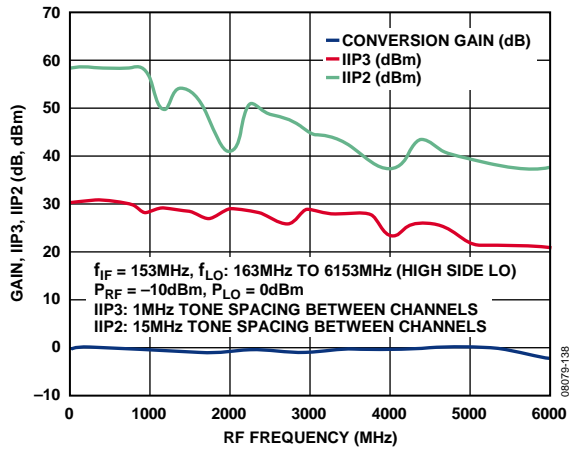

Figure 102. Sample Setup Configuration with the MiniCircuits TCM1-63AX+ Broadband Balun

08079-137

Figure 103 to Figure 105 demonstrate the performance of the mixer with the MiniCircuits TCM1-63AX+ populated on the RF and LO ports.



The device maintains an Input IP3 of 20 dBm or better and conversion gain of -2 dB or better across the 10 MHz to 6 GHz frequency band.

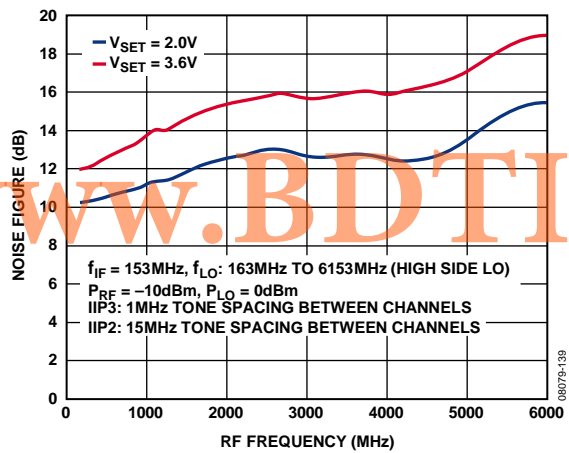

www.BDTTC.com/cn/adi

SINGLE-ENDED DRIVE OF RF AND LO INPUTS

The RF and LO ports of the active mixer can be driven single-ended without baluns for single-ended operation. In this configuration, the unused RF and LO ports should be ac grounded using a 1 nF capacitor. Figure 106 depicts setup configuration suggested to operate the device in the single-ended mode.

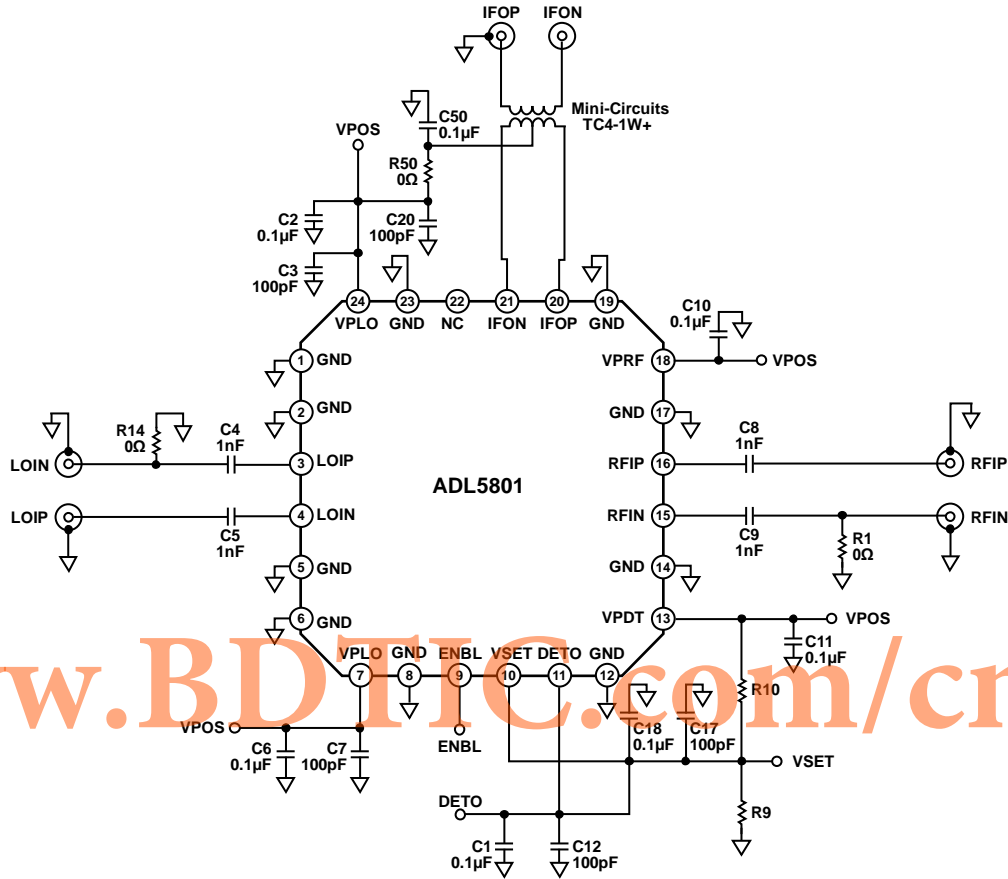

Figure 106. Single-Ended Configuration to Operate the ADL5801

08079-141

Figure 107 to Figure 109 demonstrate the performance of the mixer in the single ended mode.

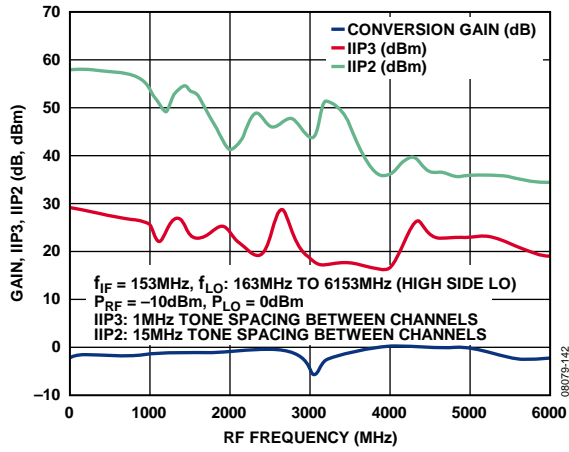

Figure 107. Gain, IIP3, IIP2 vs. RF Frequency

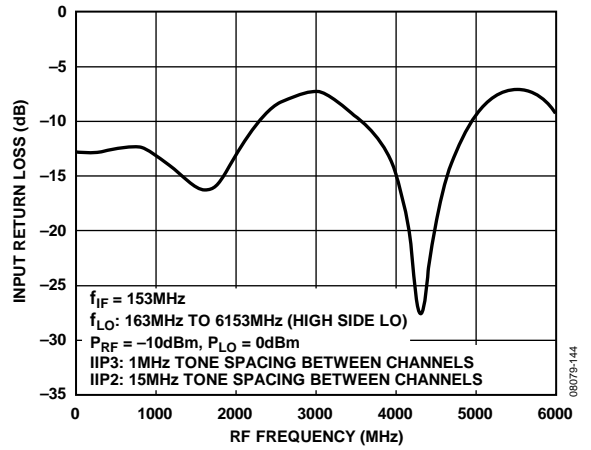

Figure 109. Input Return Loss vs. RF Frequency

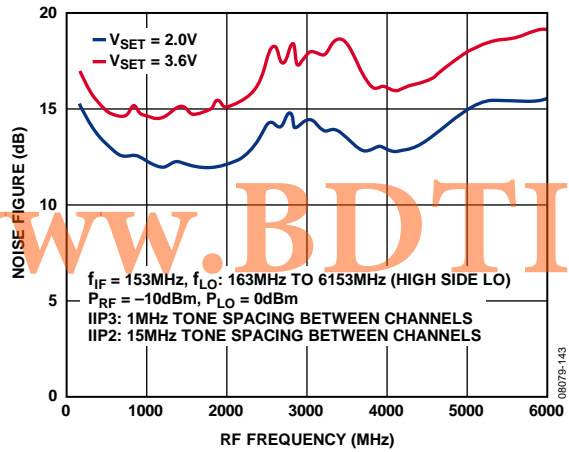

Figure 108. Noise Figure vs. RF Frequency

www.BDTIC.com/cn/adi

EVALUATION BOARD

An evaluation board is available for the ADL5801. The standard evaluation board is fabricated using Rogers® RO3003 material. Each RF, LO, and IF port is configured for single-ended signaling via a balun transformer. The schematic for the evaluation board is shown in Figure 110. Table 9 describes the various configuration options for the evaluation board. Layout for the board is shown in Figure 111 and Figure 112.

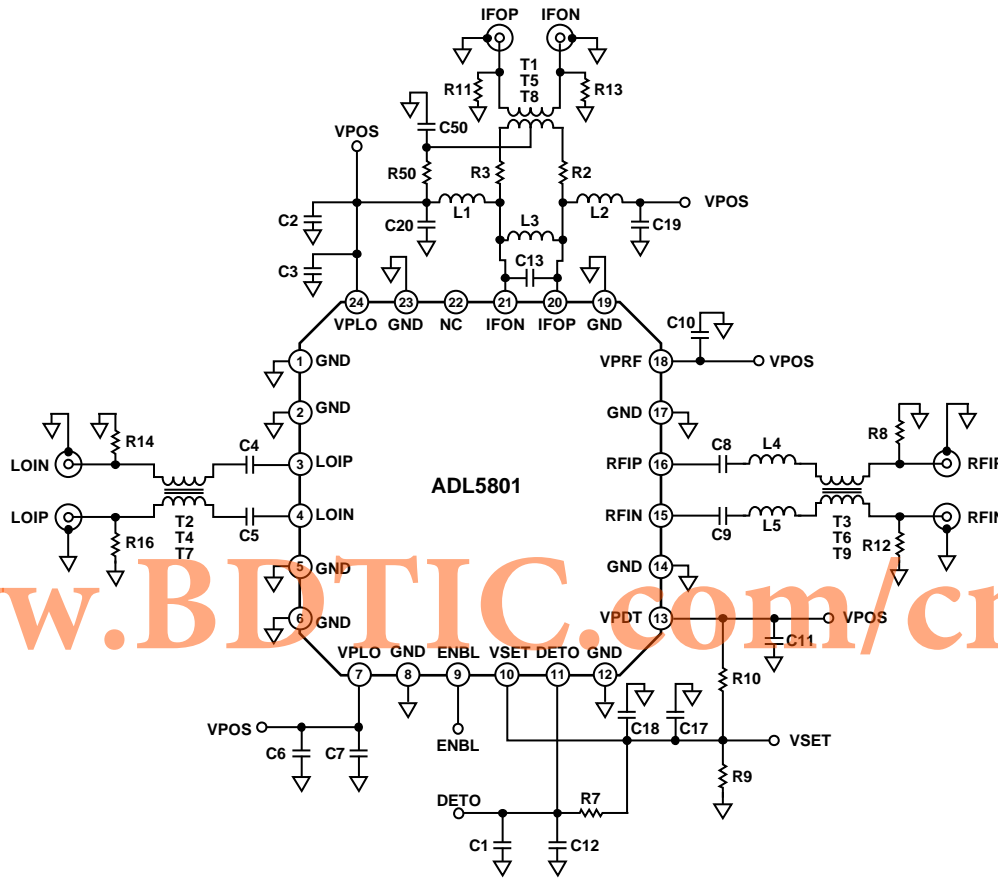

Figure 110. Evaluation Board Schematic

08079-133

Table 9. Evaluation Board Configuration

Components	Function	Default Conditions
C2, C3, C6, C7, C10, C11	Power supply decoupling. Nominal supply decoupling consists of a 0.1 μF capacitor to ground in parallel with 100 pF capacitors to ground, positioned as close to the device as possible. Series resistors are provided for enhanced supply decoupling using optional ferrite chip inductors.	C2, C6, C10, C11 = 0.1 μF (size 0402) C3, C7 = 100 pF (size 0402)
C8, C9, L4, L5, R4, R8, R12, T3, T6, T9, RFIN, RFIP	RF input interfaces. (Use RFIN for operation). Input channels are ac-coupled through C8 and C9. R8 and R12 provide options when additional matching is needed. T3 is a 1:1 balun used to interface to the 50 Ω differential inputs. T6 and T9 provide options when high frequency baluns are used and require smaller balun footprints.	C8, C9 = 1 nF (size 0402) L4, L5 = 0 Ω (size 0402) R12 = open (size 0402) R4, R8 = 0 Ω (size 0402) T3 = TCM1-63AX+ (Mini-Circuits)
C13, C19, C20, C50, L1, L2, L3, R2, R3, R11, R13, R50, T1, T5, T8, IFON, IFOP	IF output interfaces. The 200 Ω open collector IF output interfaces are biased through the center tap of a 4:1 impedance transformer at T1. C50 provides local bypassing with R50 available for additional supply bypassing. L1 and L2 provide options when pull-up choke inductors are used to bias the open-collector outputs. C13, L3, R2, and R3 are provided for IF filtering and matching options. T5 and T8 provide options when high frequency baluns are used and require smaller balun footprints.	C13 = open (size 0402) C19, C20 = 100 pF (size 0402) C50 = 0.1 μF (size 0402) L1, L2 = open (size 0805) L3 = open (size 0402) R2, R3, R13, R50 = 0 Ω (size 0402) R11 = open (size 0402) T1 = TC4-1W+ (Mini-Circuits)
C4, C5, R14, R16, T2, T4, T7, LOIN, LOIP	LO interface. (Use LOIN for operation). C4 and C5 provide ac coupling for the local oscillator input. T2 is a 1:1 balun that allows single-ended interfacing to the differential 50 Ω local oscillator input. T4 and T7 provide options when high frequency baluns are used and require smaller balun footprints.	C4, C5 = 1 nF (size 0402) R14 = open (size 0402) R16 = 0 Ω (size 0402) T2 = TCM1-63AX+
C1, C12, R7, DETO	DETO interface. C1 and C12 provide decoupling for the DETO pin. R7 provides access to the VSET pin when automatic input IP3 control is needed.	C1 = 0.1 μF (size 0603) C12 = 100 pF (size 0402) R7 = open (size 0402)
C17, C18, R9, R10, VSET	VSET bias control. C17 and C18 provide decoupling for the VSET pin. R9 and R10 form an optional resistor divider network between VPOS and GND, allowing for a fixed bias setting. Supply 3.8 V at the VSET pin when the DETO pin is not connected for automatic input IP3 control.	C17 = 100 pF (size 0402) C18 = 0.1 μF (size 0603) R9, R10 = open (size 0402)

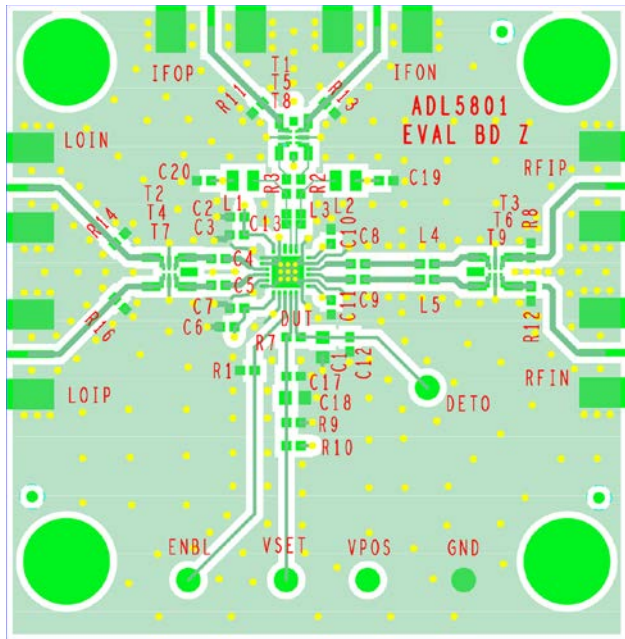

Figure 111. Evaluation Board Top Layer

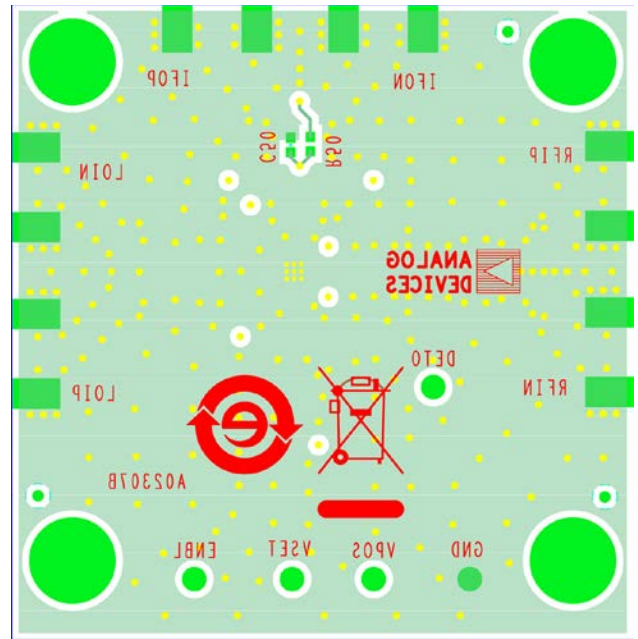
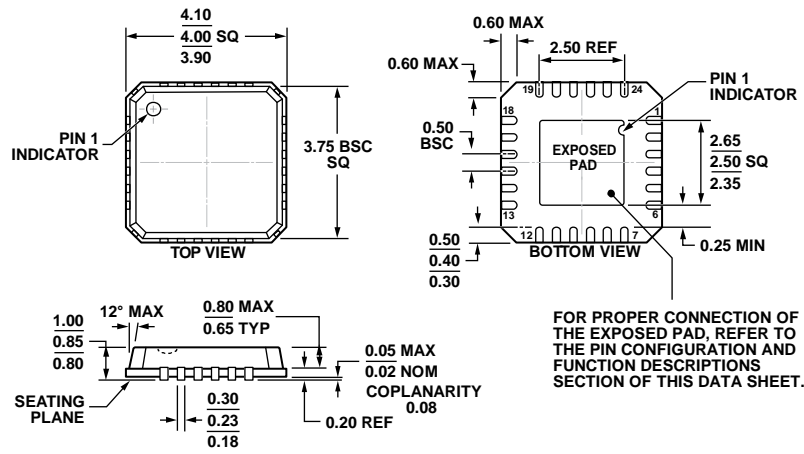

Figure 112. Evaluation Board Bottom Layer

OUTLINE DIMENSIONS



COMPLIANT TO JEDEC STANDARDS MO-220-VGGD-8

Figure 113. 24-Lead Lead Frame Chip Scale Package [LFCSP_VQ]
 4 mm × 4 mm Body, Very Thin Quad (CP-24-3)
 Dimensions shown in millimeters

ORDERING GUIDE

Model ¹	Temperature Range	Package Description	Package Option	Ordering Quantity
ADL5801ACPZ-R7	-40°C to +85°C	24-Lead Lead Frame Chip Scale Package [LFCSP_VQ]	CP-24-3	1,500 per Reel
ADL5801-EVALZ		Evaluation Board		1

¹ Z = RoHS Compliant Part.