

74LCX16821

Low Voltage 20-Bit D-Type Flip-Flop with 5V Tolerant Inputs and Outputs

General Description

The LCX16821 contains twenty non-inverting D-type flip-flops with 3-STATE outputs and is intended for bus oriented applications. The device is designed for low voltage (2.5V or 3.3V) V_{CC} applications with capability of interfacing to a 5V signal environment.

The LCX16821 is fabricated with an advanced CMOS technology to achieve high speed operation while maintaining CMOS low power dissipation.

Features

- 5V tolerant inputs and outputs
- 2.3V–3.6V V_{CC} specifications provided
- 6.2 ns t_{PD} max ($V_{CC} = 3.3V$), 20 μA I_{CC} max
- Power down high impedance inputs and outputs
- Supports live insertion/withdrawal (Note 1)
- ± 24 mA output drive ($V_{CC} = 3.0V$)
- Implements patented noise/EMI reduction circuitry
- Latch-up performance exceeds 500 mA
- ESD performance:
 - Human body model > 2000V
 - Machine model > 200V

Note 1: To ensure the high-impedance state during power up or down, \overline{OE} should be tied to V_{CC} through a pull-up resistor: the minimum value or the resistor is determined by the current-sourcing capability of the driver.

Ordering Code:

Order Number	Package Number	Package Description
74LCX16821MEA	MS56A	56-Lead Shrink Small Outline Package (SSOP), JEDEC MO-118, 0.300" Wide
74LCX16821MTD	MTD56	56-Lead Thin Shrink Small Outline Package (TSSOP), JEDEC MO-153, 6.1mm Wide

Devices also available in Tape and Reel. Specify by appending suffix letter "X" to the ordering code.

Logic Symbol

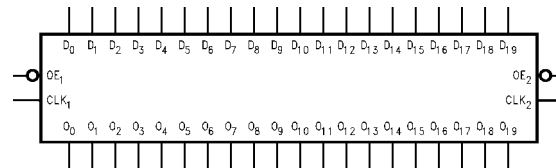

Pin Descriptions

Pin Names	Description
\overline{OE}_n	Output Enable Input (Active LOW)
CLK _n	Clock Input
D ₀ –D ₁₉	Inputs
O ₀ –O ₁₉	Outputs

Connection Diagram

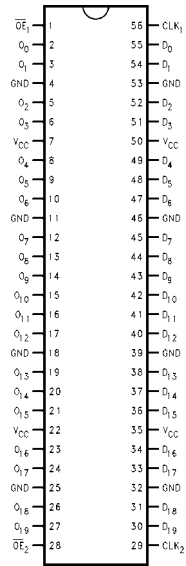

Truth Tables

Inputs			Outputs
CLK ₁	\overline{OE}_1	D ₀ -D ₉	O ₀ -O ₉
X	H	X	Z
↗	L	L	L
↗	L	H	H
L or H	L	X	O ₀

Inputs			Outputs
CLK ₂	\overline{OE}_2	D ₁₀ -D ₁₉	O ₁₀ -O ₁₉
X	H	X	Z
↗	L	L	L
↗	L	H	H
L or H	L	X	O ₀

H = HIGH Voltage Level
 L = LOW Voltage Level
 X = Immaterial
 Z = High Impedance
 O₀ = Previous O₀ before LOW-to-HIGH transition of Clock
 ↗ = LOW-to-HIGH transition

Functional Description

The LCX16821 contains twenty D-type flip-flops with 3-STATE standard outputs. The device is byte controlled with each byte functioning identically, but independent of the other. Control pins can be shorted together to obtain full 20-bit operation. The following description applies to each byte. The twenty flip-flops will store the state of their individual D inputs that meet the setup and hold time require-

ments on the LOW-to-HIGH Clock (CLK) transition. The 3-STATE standard outputs are controlled by the Output Enable (\overline{OE}_n) input. When \overline{OE}_n is LOW, the standard outputs are in the 2-state mode. When \overline{OE}_n is HIGH, the standard outputs are in the high impedance mode but this does not interfere with entering new data into the flip-flops.

Logic Diagram

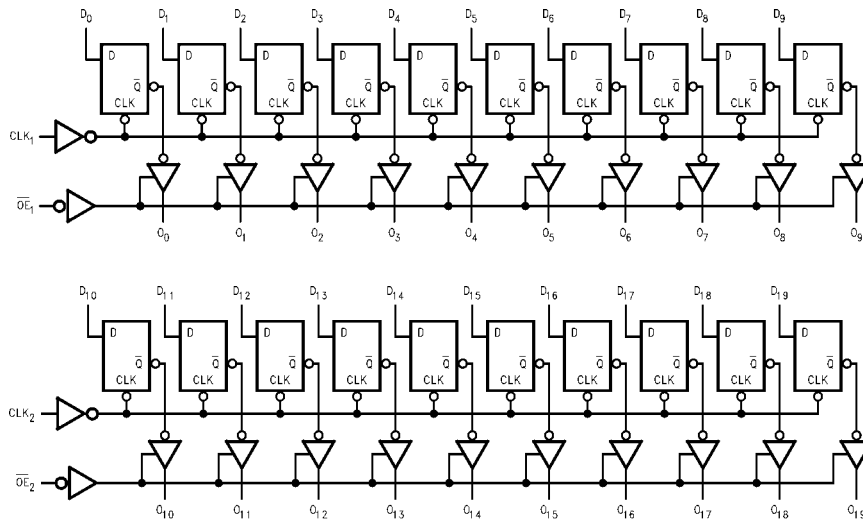

Please note that this diagram is provided only for the understanding of logic operations and should not be used to estimate propagation delays.

Absolute Maximum Ratings (Note 3)				
Symbol	Parameter	Value	Conditions	Units
V_{CC}	Supply Voltage	-0.5 to +7.0		V
V_I	DC Input Voltage	-0.5 to +7.0		V
V_O	DC Output Voltage	-0.5 to +7.0 -0.5 to $V_{CC} + 0.5$	Output in 3-STATE Output in HIGH or LOW State (Note 3)	V
I_{IK}	DC Input Diode Current	-50	$V_I < GND$	mA
I_{OK}	DC Output Diode Current	-50 +50	$V_O < GND$ $V_O > V_{CC}$	mA
I_O	DC Output Source/Sink Current	± 50		mA
I_{CC}	DC Supply Current per Supply Pin	± 100		mA
I_{GND}	DC Ground Current per Ground Pin	± 100		mA
T_{STG}	Storage Temperature	-65 to +150		$^{\circ}C$

Recommended Operating Conditions (Note 4)				
Symbol	Parameter	Min	Max	Units
V_{CC}	Supply Voltage			
	Operating	2.0	3.6	V
	Data Retention	1.5	3.6	V
V_I	Input Voltage	0	5.5	V
V_O	Output Voltage			
	HIGH or LOW State	0	V_{CC}	V
	3-STATE	0	5.5	V
I_{OH}/I_{OL}	Output Current			
	$V_{CC} = 3.0V - 3.6V$		± 24	mA
	$V_{CC} = 2.7V - 3.0V$		± 12	mA
	$V_{CC} = 2.3V - 2.7V$		± 8	mA
T_A	Free-Air Operating Temperature	-40	85	$^{\circ}C$
$\Delta t/\Delta V$	Input Edge Rate, $V_{IN} = 0.8V - 2.0V$, $V_{CC} = 3.0V$	0	10	ns/V

Note 2: The Absolute Maximum Ratings are those values beyond which the safety of the device cannot be guaranteed. The device should not be operated at these limits. The parametric values defined in the Electrical Characteristics tables are not guaranteed at the Absolute Maximum Ratings. The "Recommended Operating Conditions" table will define the conditions for actual device operation.

Note 3: I_O Absolute Maximum Rating must be observed.

Note 4: Unused pins (Inputs and I/O) must be held HIGH or LOW. They may not float.

DC Electrical Characteristics

Symbol	Parameter	Conditions	V_{CC} (V)	$T_A = -40^{\circ}C$ to $+85^{\circ}C$		Units
				Min	Max	
V_{IH}	HIGH Level Input Voltage		2.3 - 2.7 2.7 - 3.6	1.7 2.0		V
V_{IL}	LOW Level Input Voltage		2.3 - 2.7 2.7 - 3.6		0.7 0.8	V
V_{OH}	HIGH Level Output Voltage	$I_{OH} = -100 \mu A$ $I_{OH} = -8 \text{ mA}$ $I_{OH} = -12 \text{ mA}$ $I_{OH} = -18 \text{ mA}$ $I_{OH} = -24 \text{ mA}$	2.3 - 3.6 2.3 2.7 3.0 3.0	$V_{CC} - 0.2$ 1.8 2.2 2.4 2.2		V
V_{OL}	LOW Level Output Voltage	$I_{OL} = 100 \mu A$ $I_{OL} = 8 \text{ mA}$ $I_{OL} = 12 \text{ mA}$ $I_{OL} = 16 \text{ mA}$ $I_{OL} = 24 \text{ mA}$	2.3 - 3.6 2.3 2.7 3.0 3.0		0.2 0.6 0.4 0.4 0.55	V
I_I	Input Leakage Current	$0 \leq V_I \leq 5.5V$	2.3 - 3.6		± 5.0	μA
I_{OZ}	3-STATE Output Leakage	$0 \leq V_O \leq 5.5V$ $V_I = V_{IH}$ or V_{IL}	2.3 - 3.6		± 5.0	μA
I_{OFF}	Power-Off Leakage Current	V_I or $V_O = 5.5V$	0		10	μA

DC Electrical Characteristics (Continued)								
Symbol	Parameter	Conditions	V _{CC} (V)	T _A = -40°C to +85°C		Units		
				Min	Max			
I _{CC}	Quiescent Supply Current	V _I = V _{CC} or GND	2.3 – 3.6		20	μA		
		3.6V ≤ V _I , V _O ≤ 5.5V (Note 5)	2.3 – 3.6		±20			
ΔI _{CC}	Increase in I _{CC} per Input	V _{IH} = V _{CC} - 0.6V	2.3 – 3.6		500	μA		
Note 5: Outputs disabled or 3-STATE only.								
AC Electrical Characteristics								
Symbol	Parameter	T _A = -40°C to +85°C, R _L = 500Ω						Units
		V _{CC} = 3.3V ± 0.3V		V _{CC} = 2.7V		V _{CC} = 2.5V ± 0.2V		
		C _L = 50 pF		C _L = 50 pF		C _L = 30 pF		
		Min	Max	Min	Max	Min	Max	
f _{MAX}	Maximum Clock Frequency	150					MHz	
t _{PHL}	Propagation Delay	1.5	6.2	1.5	6.5	1.5	7.4	ns
t _{PLH}	CLK to O _n	1.5	6.2	1.5	6.5	1.5	7.4	
t _{PZL}	Output Enable Time	1.5	6.5	1.5	7.0	1.5	8.5	ns
t _{PZH}		1.5	6.5	1.5	7.0	1.5	8.5	
t _{PLZ}	Output Disable Time	1.5	6.5	1.5	7.0	1.5	7.8	ns
t _{PHZ}		1.5	6.5	1.5	7.0	1.5	7.8	
t _{OSSL}	Output to Output Skew (Note 6)		1.0					ns
t _{OSLH}			1.0					
t _S	Setup Time, D _n to CLK	2.5		2.5		3.0		ns
t _H	Hold Time, D _n to CLK	1.5		1.5		2.0		ns
t _W	CLK Pulse Width	3.3		3.3		3.8		ns
Note 6: Skew is defined as the absolute value of the difference between the actual propagation delay for any two separate outputs of the same device. The specification applies to any outputs switching in the same direction, either HIGH-to-LOW (t _{OSSL}) or LOW-to-HIGH (t _{OSLH}).								
Dynamic Switching Characteristics								
Symbol	Parameter	Conditions	V _{CC} (V)	T _A = 25°C	Units			
				Typical				
V _{OLP}	Quiet Output Dynamic Peak V _{OL}	C _L = 50 pF, V _{IH} = 3.3V, V _{IL} = 0V	3.3	1.0	V			
		C _L = 30 pF, V _{IH} = 2.5V, V _{IL} = 0V	2.5	0.6				
V _{OLV}	Quiet Output Dynamic Valley V _{OL}	C _L = 50 pF, V _{IH} = 3.3V, V _{IL} = 0V	3.3	-0.8	V			
		C _L = 30 pF, V _{IH} = 2.5V, V _{IL} = 0V	2.5	-0.6				
Capacitance								
Symbol	Parameter	Conditions	Typical	Units				
C _{IN}	Input Capacitance	V _{CC} = Open, V _I = 0V or V _{CC}	7	pF				
C _O	Output Capacitance	V _{CC} = 3.3V, V _I = 0V or V _{CC}	8	pF				
C _{PD}	Power Dissipation Capacitance	V _{CC} = 3.3V, V _I = 0V or V _{CC} , f = 10 MHz	20	pF				

AC LOADING and WAVEFORMS Generic for LCX Family

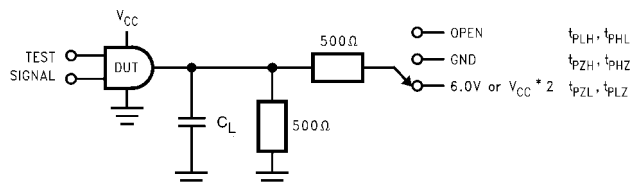
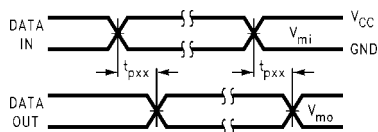
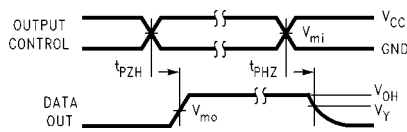

FIGURE 1. AC Test Circuit (C_L includes probe and jig capacitance)

Test	Switch
t_{PLH}, t_{PHL}	Open
t_{PZL}, t_{PLZ}	6V at $V_{CC} = 3.3 \pm 0.3V$ $V_{CC} \times 2$ at $V_{CC} = 2.5 \pm 0.2V$
t_{PZH}, t_{PHZ}	GND



Waveform for Inverting and Non-Inverting Functions



3-STATE Output High Enable and Disable Times for Logic

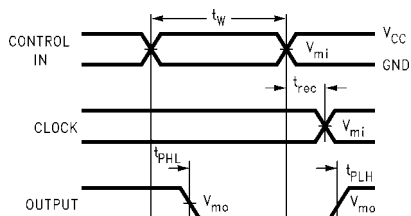

Propagation Delay, Pulse Width and t_{rec} Waveforms

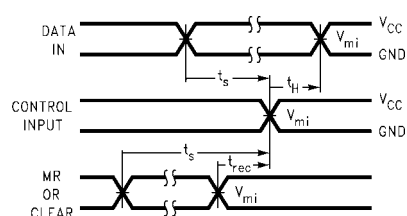

Setup Time, Hold Time and Recovery Time for Logic

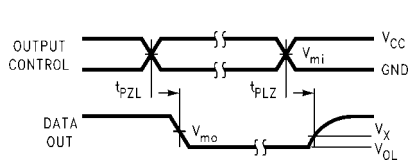

3-STATE Output Low Enable and Disable Times for Logic

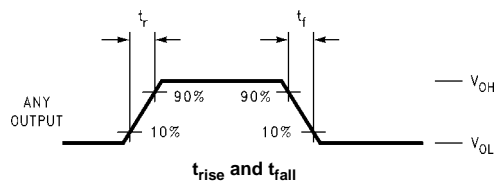
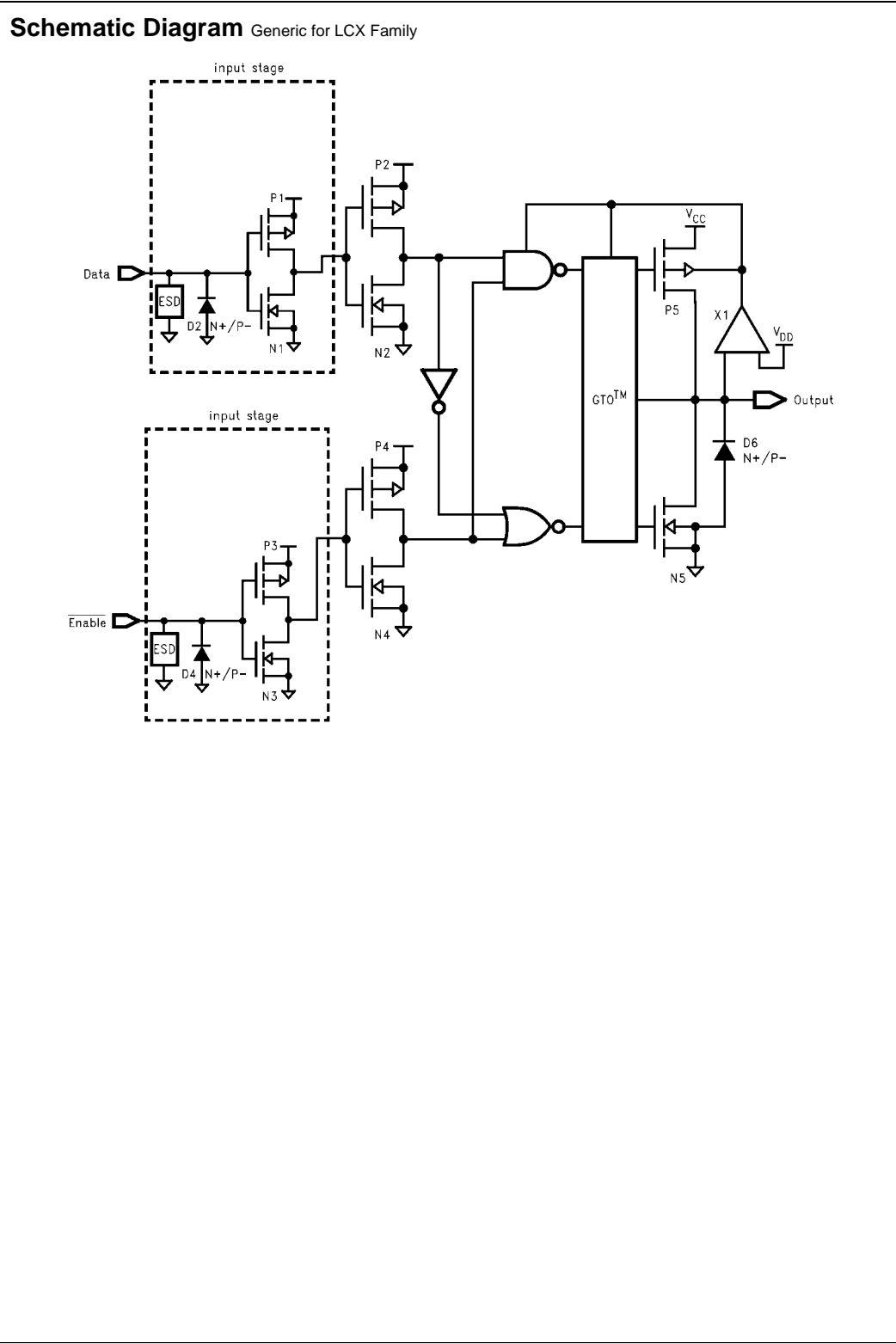
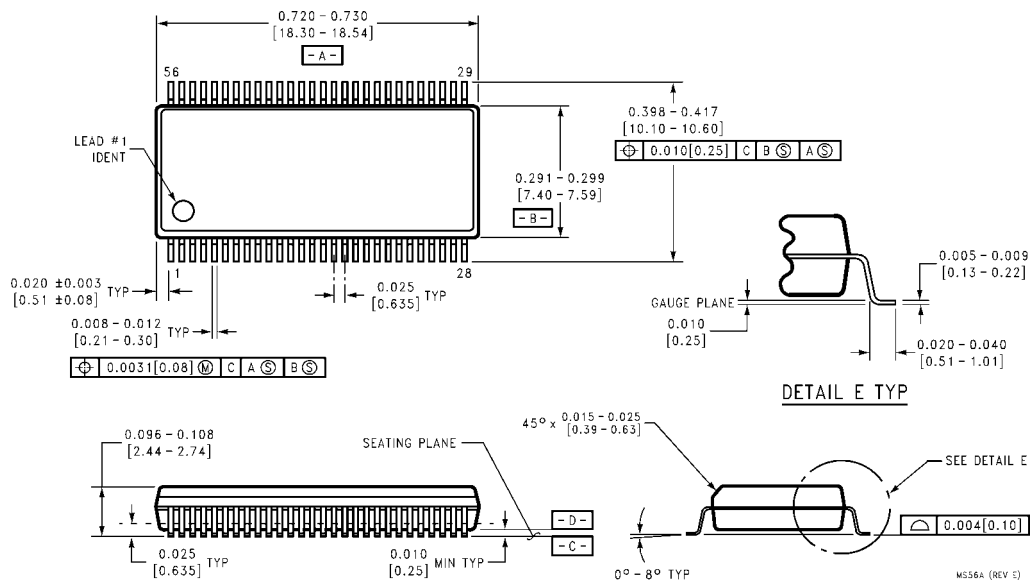

FIGURE 2. Waveforms
(Input Characteristics; $f = 1MHz, t_R = t_F = 3ns$)

Symbol	V_{CC}		
	$3.3V \pm 0.3V$	2.7V	$2.5V \pm 0.2V$
V_{mi}	1.5V	1.5V	$V_{CC}/2$
V_{mo}	1.5V	1.5V	$V_{CC}/2$
V_x	$V_{OL} + 0.3V$	$V_{OL} + 0.3V$	$V_{OL} + 0.15V$
V_y	$V_{OH} - 0.3V$	$V_{OH} - 0.3V$	$V_{OH} - 0.15V$



Physical Dimensions inches (millimeters) unless otherwise noted



**56-Lead Shrink Small Outline Package (SSOP), JEDEC MO-118, 0.300" Wide
Package Number MS56A**

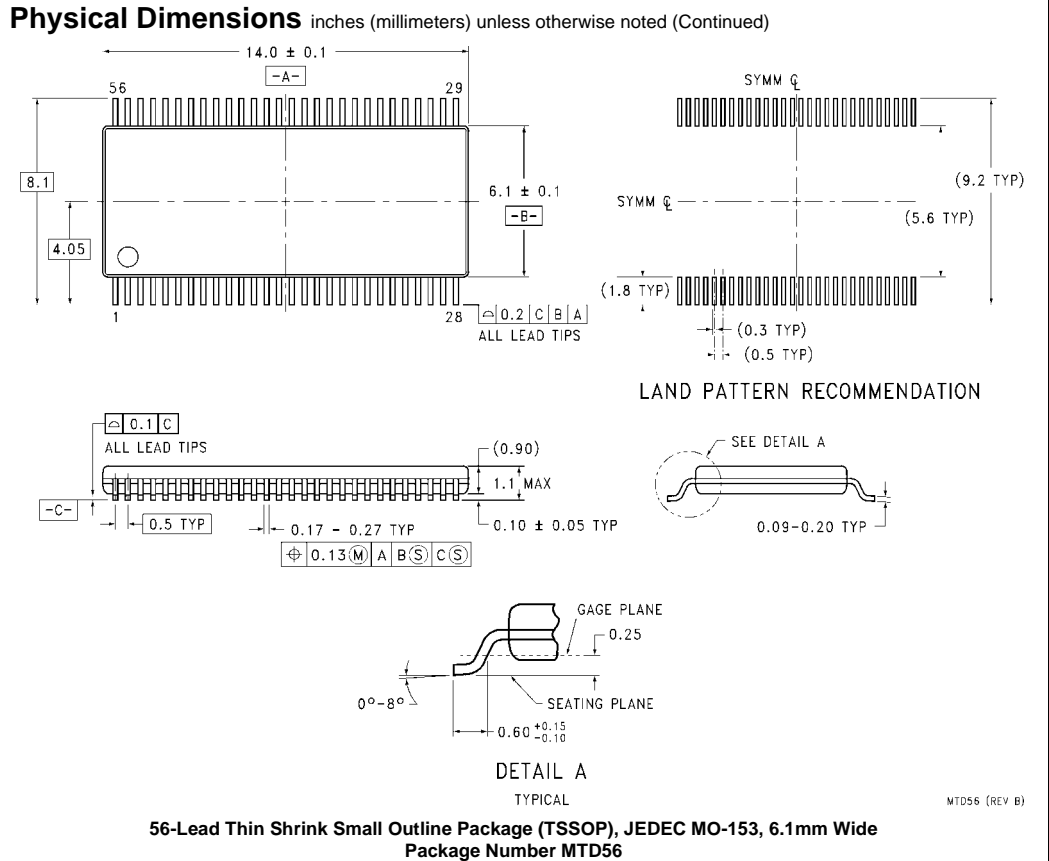

LIFE SUPPORT POLICY

FAIRCHILD'S PRODUCTS ARE NOT AUTHORIZED FOR USE AS CRITICAL COMPONENTS IN LIFE SUPPORT DEVICES OR SYSTEMS WITHOUT THE EXPRESS WRITTEN APPROVAL OF THE PRESIDENT OF FAIRCHILD SEMICONDUCTOR CORPORATION. As used herein:

1. Life support devices or systems are devices or systems which, (a) are intended for surgical implant into the body, or (b) support or sustain life, and (c) whose failure to perform when properly used in accordance with instructions for use provided in the labeling, can be reasonably expected to result in a significant injury to the user.
2. A critical component in any component of a life support device or system whose failure to perform can be reasonably expected to cause the failure of the life support device or system, or to affect its safety or effectiveness.

www.fairchildsemi.com