

FEATURES

- **Wide RF Frequency Range: 400MHz to 3.8GHz***
- **High Input IP3:** 25.6dBm at 900MHz
24.7dBm at 1950MHz
23.7dBm at 2.6GHz
- **Conversion Gain:** 3.3dB at 900MHz
2.9dB at 1950MHz
- **-3dBm LO Drive Level**
- **Low LO Leakage**
- **Low Noise Figure:** 10.6dB at 900MHz
11.7dB at 1950MHz
- **Low Power: 3.3V/269mW**
- **50Ω Single-Ended RF and LO Ports**
- Very Few External Components
- 16-Lead (4mm × 4mm) QFN Package

APPLICATIONS

- Cellular, CDMA, WCDMA, TD-SCDMA and UMTS Infrastructure
- WiMAX
- Wireless Infrastructure Receiver
- Wireless Infrastructure PA Linearization
- 900MHz/2.4GHz/3.5GHz WLAN

DESCRIPTION

The LT[®]5557 active mixer is optimized for high linearity, wide dynamic range downconverter applications. The IC includes a high speed differential LO buffer amplifier driving a double-balanced mixer. Broadband, integrated transformers on the RF and LO inputs provide single-ended 50Ω interfaces. The differential IF output allows convenient interfacing to differential IF filters and amplifiers, or is easily matched to drive a single-ended 50Ω load, with or without an external transformer.

The RF input is internally matched to 50Ω from 1.6GHz to 2.3GHz, and the LO input is internally matched to 50Ω from 1GHz to 5GHz. The frequency range of both ports is easily extended with simple external matching. The IF output is partially matched and usable for IF frequencies up to 600MHz.

The LT5557's high level of integration minimizes the total solution cost, board space and system-level variation.

LT, LT, LTC, LTM, Linear Technology and the Linear logo are registered trademarks of Linear Technology Corporation. All other trademarks are the property of their respective owners.* Operation over a wider frequency range is possible with reduced performance. Consult factory for information and assistance.

TYPICAL APPLICATION

High Signal Level Downmixer for Multi-Carrier Wireless Infrastructure

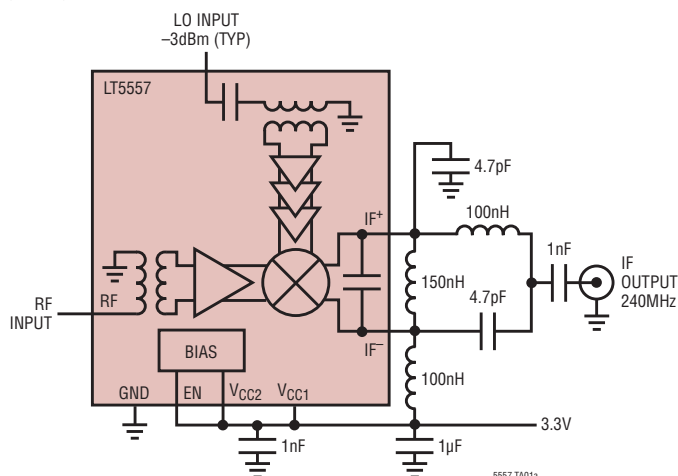

Conversion Gain, IIP3, SSB NF and LO Leakage vs RF Frequency

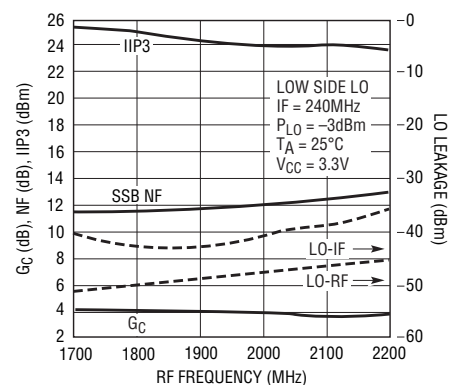

ABSOLUTE MAXIMUM RATINGS

(Note 1)

| | |
|------------------------------------------------------------|--------------------------|
| Supply Voltage (V_{CC1} , V_{CC2} , IF^+ , IF^-) | 4V |
| Enable Voltage | -0.3V to $V_{CC} + 0.3V$ |
| LO Input Power (380MHz to 4.2GHz) | +10dBm |
| LO Input DC Voltage | -1V to $V_{CC} + 1V$ |
| RF Input Power (400MHz to 3.8GHz) | +15dBm |
| Continuous RF Input Power (400MHz to 3.8GHz) | +12dBm |
| RF Input DC Voltage | $\pm 0.1V$ |
| Operating Temperature Range | -40°C to 85°C |
| Storage Temperature Range | -65°C to 125°C |
| Junction Temperature (T_J) | 125°C |

PIN CONFIGURATION

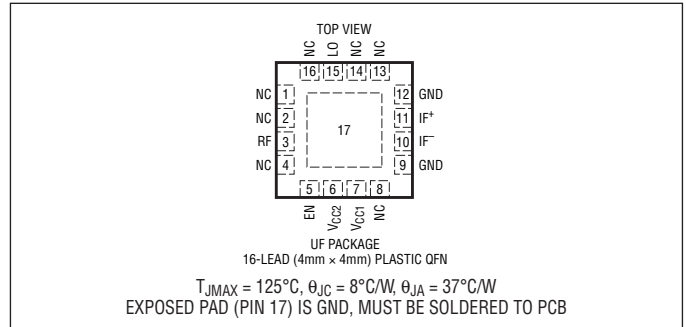

CAUTION: This part is sensitive to electrostatic discharge (ESD). It is very important that proper ESD precautions be observed when handling the LT5557.

ORDER INFORMATION

| LEAD FREE FINISH | TAPE AND REEL | PART MARKING | PACKAGE DESCRIPTION | TEMPERATURE RANGE |
|------------------|-----------------|--------------|---------------------------------|-------------------|
| LT5557EUF#PBF | LT5557EUF#TRPBF | 5557 | 16-Lead (4mm × 4mm) Plastic QFN | -40°C to 85°C |

Consult LTC Marketing for parts specified with wider operating temperature ranges. Consult LTC Marketing for information on non-standard lead based finish parts.

For more information on lead free part marking, go to: <http://www.linear.com/leadfree/>

For more information on tape and reel specifications, go to: <http://www.linear.com/tapeandreel/>

DC ELECTRICAL CHARACTERISTICS

$V_{CC} = 3.3V$, $EN = High$, $T_A = 25^\circ C$, unless otherwise specified. Test circuit shown in Figure 1. (Note 3)

| PARAMETER | CONDITIONS | MIN | TYP | MAX | UNITS |
|--------------------------------------------------------|---------------------------------|-----|------|-----|---------|
| Power Supply Requirements (V_{CC}) | | | | | |
| Supply Voltage | | 2.9 | 3.3 | 3.9 | V |
| Supply Current | V_{CC1} (Pin 7) | | 25.1 | | mA |
| | V_{CC2} (Pin 6) | | 3.3 | | mA |
| | $IF^+ + IF^-$ (Pin 11 + Pin 10) | | 53.2 | 60 | mA |
| | Total Supply Current | | 81.6 | 92 | mA |
| Enable (EN) Low = Off, High = On | | | | | |
| Shutdown Current | $EN = Low$ | | | 100 | μA |
| Input High Voltage (On) | | 2.7 | | | V |
| Input Low Voltage (Off) | | | | 0.3 | V |
| EN Pin Input Current | $EN = 3.3V DC$ | | 53 | 90 | μA |
| Turn-ON Time | | | 1.6 | | μs |
| Turn-OFF Time | | | 1.6 | | μs |

AC ELECTRICAL CHARACTERISTICS

Test circuit shown in Figure 1. (Notes 2, 3)

| PARAMETER | CONDITIONS | MIN | TYP | MAX | UNITS |
|---------------------------|--------------------------------------------------------------|-----|--------------|------|-------|
| RF Input Frequency Range | No External Matching (Midband) | | 1600 to 2300 | | MHz |
| | With External Matching (Low Band or High Band) | 400 | | 3800 | MHz |
| LO Input Frequency Range | No External Matching | | 1000 to 4200 | | MHz |
| | With External Matching | 380 | | | MHz |
| IF Output Frequency Range | Requires Appropriate IF Matching | | 0.1 to 600 | | MHz |
| RF Input Return Loss | $Z_0 = 50\Omega$, 1600MHz to 2300MHz (No External Matching) | | >12 | | dB |

5557fc

AC ELECTRICAL CHARACTERISTICS Test circuit shown in Figure 1. (Notes 2, 3)

| PARAMETER | CONDITIONS | MIN | TYP | MAX | UNITS |
|----------------------|--------------------------------------------------------------|----------|----------------------|--------|------------|
| LO Input Return Loss | $Z_0 = 50\Omega$, 1000MHz to 5000MHz (No External Matching) | | >10 | | dB |
| IF Output Impedance | Differential at 240MHz | | 529 Ω 2.6pF | | R C |
| LO Input Power | 1200MHz to 4200MHz 380MHz to 1200MHz | -8 -5 | -3 0 | 2 5 | dBm dBm |

Standard Downmixer Application: $V_{CC} = 3.3V$, EN = High, $T_A = 25^\circ C$, $P_{RF} = -6dBm$ (-6dBm/tone for 2-tone IIP3 tests, $\Delta f = 1MHz$), $f_{LO} = f_{RF} - f_{IF}$, $P_{LO} = -3dBm$ (0dBm for 450MHz and 900MHz tests), IF output measured at 240MHz, unless otherwise noted. Test circuit shown in Figure 1. (Notes 2, 3, 4)

| PARAMETER | CONDITIONS | MIN | TYP | MAX | UNITS |
|---------------------------------------------------------------------|-----------------------------------------------------------------------------------------------------------------------------------------------------------------------------|-----|------------------------------------------------------|-----|-----------------------------------------------|
| Conversion Gain | RF = 450MHz, IF = 70MHz, High Side LO RF = 900MHz, IF = 140MHz RF = 1750MHz RF = 1950MHz RF = 2150MHz RF = 2600MHz, IF = 360MHz RF = 3600MHz, IF = 450MHz | | 2.9 3.3 3.0 2.9 2.9 2.5 1.7 | | dB dB dB dB dB dB dB |
| Conversion Gain vs Temperature | $T_A = -40^\circ C$ to $85^\circ C$, RF = 1950MHz | | -0.0217 | | dB/ $^\circ C$ |
| Input 3rd Order Intercept | RF = 450MHz, IF = 70MHz, High Side LO RF = 900MHz, IF = 140MHz RF = 1750MHz RF = 1950MHz RF = 2150MHz RF = 2600MHz, IF = 360MHz RF = 3600MHz, IF = 450MHz | | 24.1 25.6 25.5 24.7 24.3 23.7 23.5 | | dBm dBm dBm dBm dBm dBm dBm |
| Single-Sideband Noise Figure | RF = 450MHz, IF = 70MHz, High Side LO RF = 900MHz, IF = 140MHz RF = 1750MHz RF = 1950MHz RF = 2150MHz RF = 2600MHz, IF = 360MHz RF = 3600MHz, IF = 450MHz | | 12.7 10.6 11.3 11.7 12.8 13.2 15.4 | | dB dB dB dB dB dB dB |
| LO to RF Leakage | $f_{LO} = 380MHz$ to 1600MHz $f_{LO} = 1600MHz$ to 4000MHz | | ≤ -50 ≤ -45 | | dBm dBm |
| LO to IF Leakage | $f_{LO} = 380MHz$ to 2200MHz $f_{LO} = 2200MHz$ to 4000MHz | | ≤ -42 ≤ -38 | | dBm dBm |
| RF to LO Isolation | $f_{RF} = 400MHz$ to 1700MHz $f_{RF} = 1700MHz$ to 3800MHz | | >50 >42 | | dB dB |
| RF to IF Isolation | $f_{RF} = 400MHz$ to 2300MHz $f_{RF} = 2300MHz$ to 3800MHz | | >41 >37 | | dB dB |
| 2RF-2LO Output Spurious Product ($f_{RF} = f_{LO} + f_{IF}/2$) | 900MHz: $f_{RF} = 830MHz$ at -6dBm, $f_{IF} = 140MHz$ 1950MHz: $f_{RF} = 1830MHz$ at -6dBm, $f_{IF} = 240MHz$ | | -61 -53 | | dBc dBc |
| 3RF-3LO Output Spurious Product ($f_{RF} = f_{LO} + f_{IF}/3$) | 900MHz: $f_{RF} = 806.67MHz$ at -6dBm, $f_{IF} = 140MHz$ 1950MHz: $f_{RF} = 1790MHz$ at -6dBm, $f_{IF} = 240MHz$ | | -83 -70 | | dBc dBc |
| Input 1dB Compression | RF = 450MHz, IF = 70MHz, High Side LO RF = 900MHz, IF = 140MHz RF = 1950MHz RF = 2600MHz, IF = 360MHz RF = 3600MHz, IF = 450MHz | | 10.0 8.8 8.8 8.6 9.1 | | dBm dBm dBm dBm dBm |

Note 1: Stresses beyond those listed under Absolute Maximum Ratings may cause permanent damage to the device. Exposure to any Absolute Maximum Rating condition for extended periods may affect device reliability and lifetime.

Note 2: 450MHz and 900MHz performance measured with external LO and RF matching. 2600MHz and 3600MHz performance measured with external RF matching. See Figure 1 and Applications Information.

Note 3: The LT5557 is guaranteed functional over the $-40^\circ C$ to $85^\circ C$ operating temperature range.

Note 4: SSB Noise Figure measurements performed with a small-signal noise source and bandpass filter on RF input, and no other RF signal applied.

TYPICAL PERFORMANCE CHARACTERISTICS $V_{CC} = 3.3V$, Test circuit shown in Figure 1. Midband (no external RF/LO matching) 240MHz IF output, $P_{RF} = -6dBm$ (-6dBm/tone for 2-tone IIP3 tests, $\Delta f = 1MHz$), $P_{LO} = -3dBm$, unless otherwise noted.

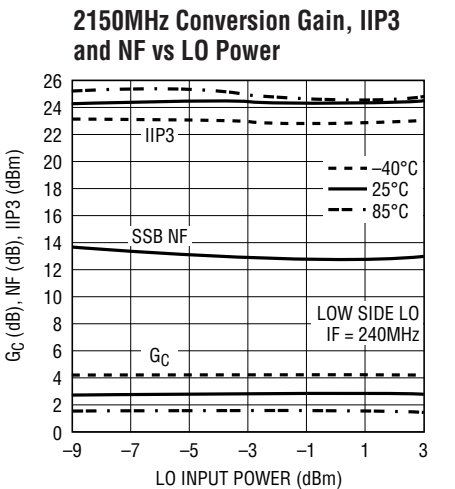
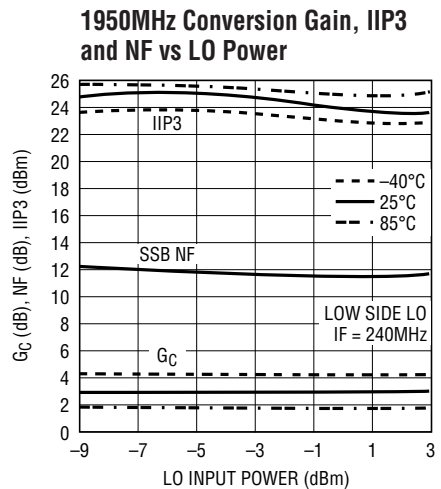
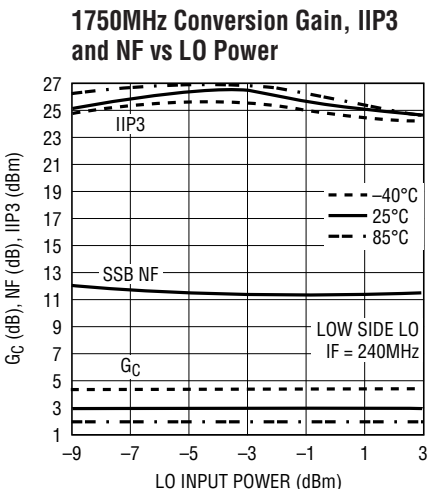
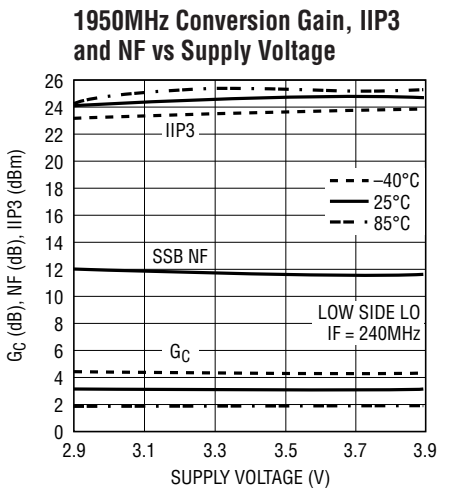
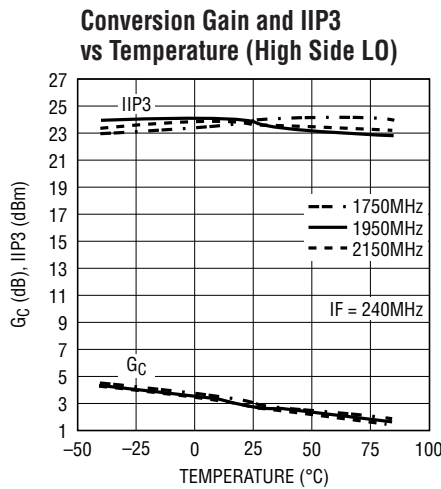
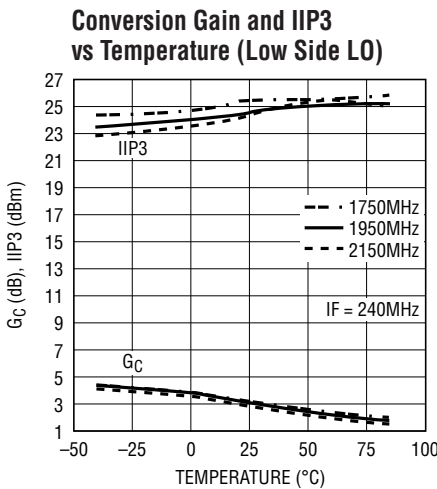
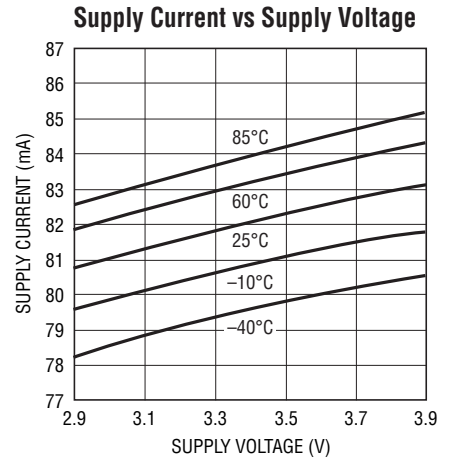
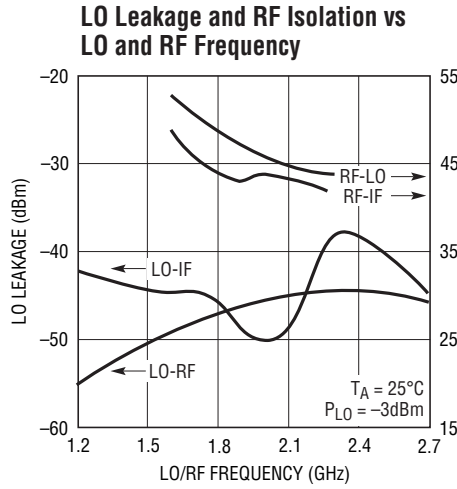
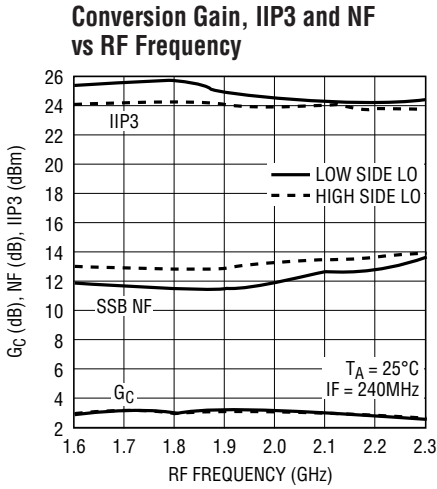

TYPICAL PERFORMANCE CHARACTERISTICS

$V_{CC} = 3.3V$, Test circuit shown in Figure 1. Midband (no external RF/LO matching) 240MHz IF output, $P_{RF} = -6dBm$ (-6dBm/tone for 2-tone IIP3 tests, $\Delta f = 1MHz$), $P_{LO} = -3dBm$, unless otherwise noted.

IF Output Power, IM3 and IM5 vs RF Input Power (2 Input Tones)

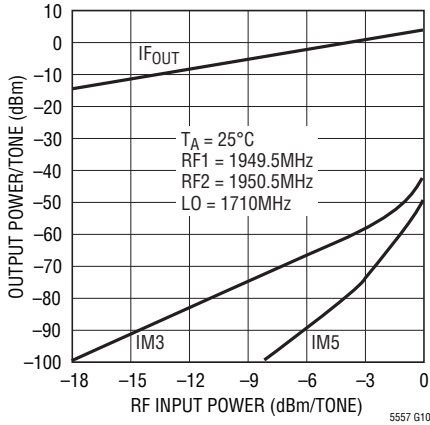

IF_{OUT}, 2 × 2 and 3 × 3 Spurs vs RF Input Power (Single Tone)

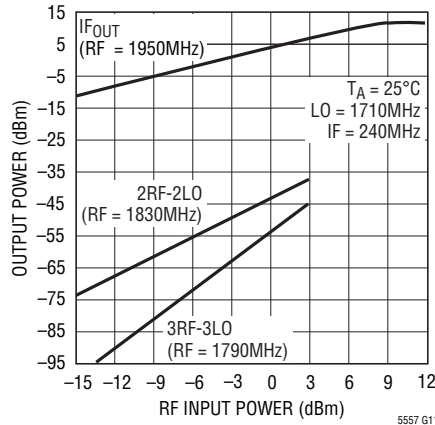

2 × 2 and 3 × 3 Spurs vs LO Power (Single Tone)

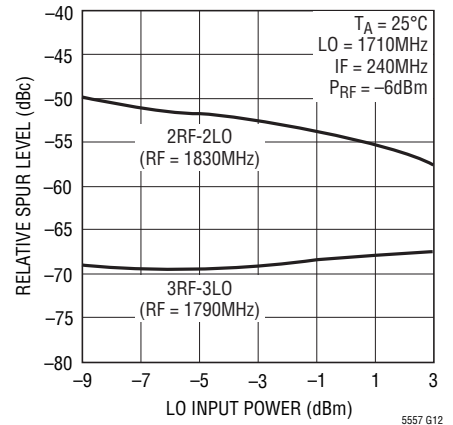

Conversion Gain Distribution at 1950MHz

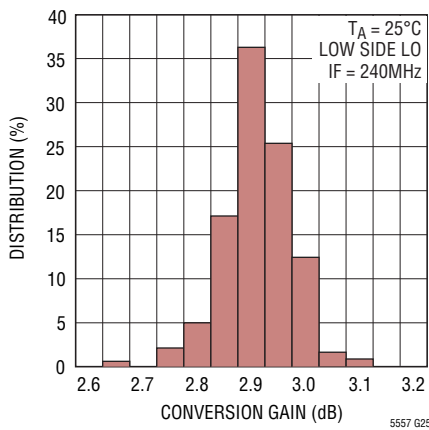

IIP3 Distribution at 1950MHz

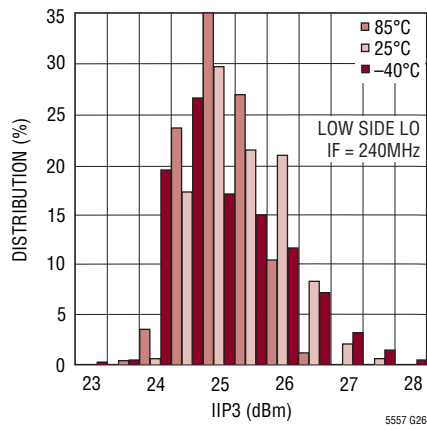

SSB Noise Figure Distribution at 1950MHz

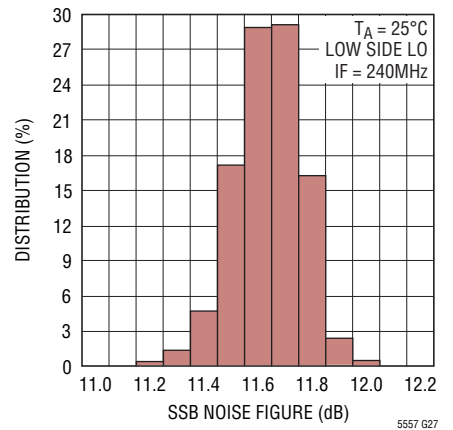

450MHz application (with external RF/LO matching) 70MHz IF output, $P_{RF} = -6dBm$ (-6dBm/tone for 2-tone IIP3 tests, $\Delta f = 1MHz$), high side LO at 0dBm, unless otherwise noted.

Conversion Gain, IIP3 and NF vs RF Frequency

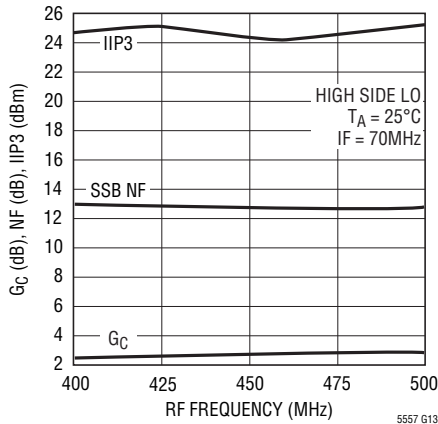

450MHz Conversion Gain, IIP3 and NF vs LO Power

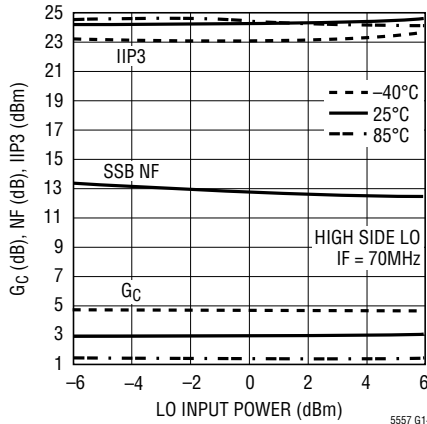

LO Leakage vs LO Frequency 450MHz and 900MHz Applications

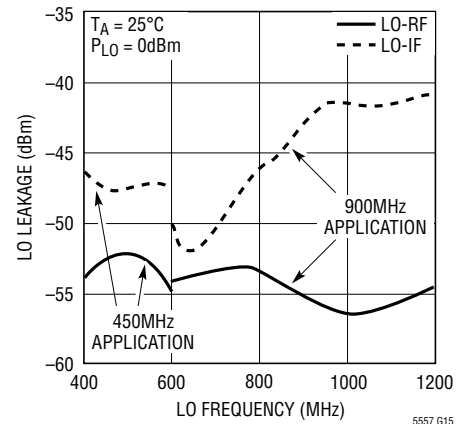

TYPICAL PERFORMANCE CHARACTERISTICS $V_{CC} = 3.3V$, Test circuit shown in Figure 1.
 900MHz application (with external RF/LO matching), 140MHz IF output, $P_{RF} = -6dBm$ (-6dBm/tone for 2-tone IIP3 tests, $\Delta f = 1MHz$), low side LO at 0dBm, unless otherwise noted.

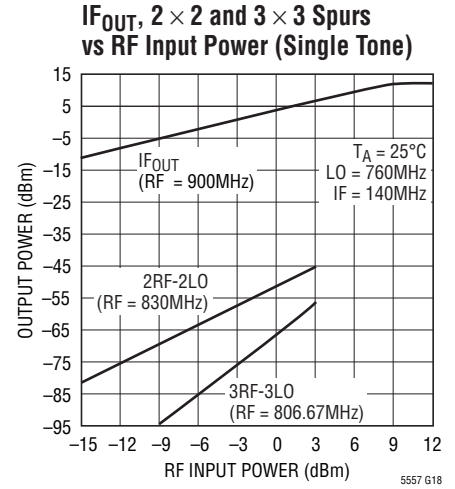
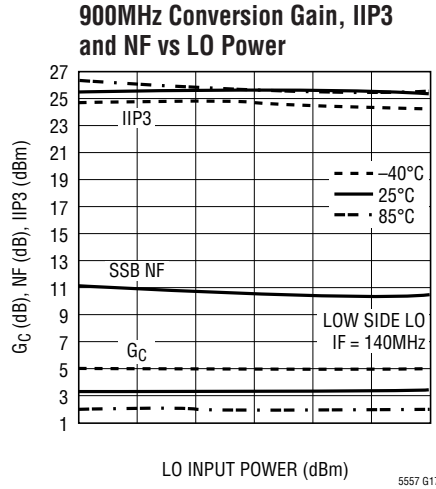
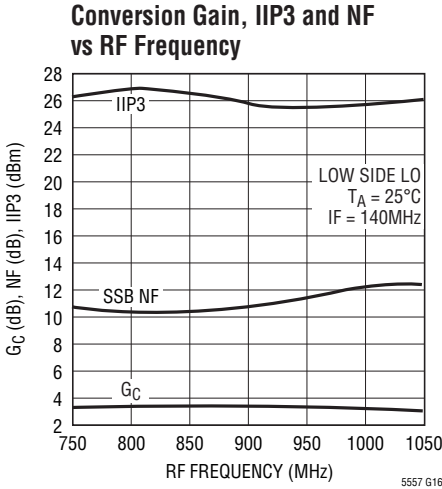

2.3GHz to 2.7GHz application (with external RF matching) 360MHz IF output, $P_{RF} = -6dBm$ (-6dBm/tone for 2-tone IIP3 tests, $\Delta f = 1MHz$), $P_{LO} = -3dBm$, unless otherwise noted.

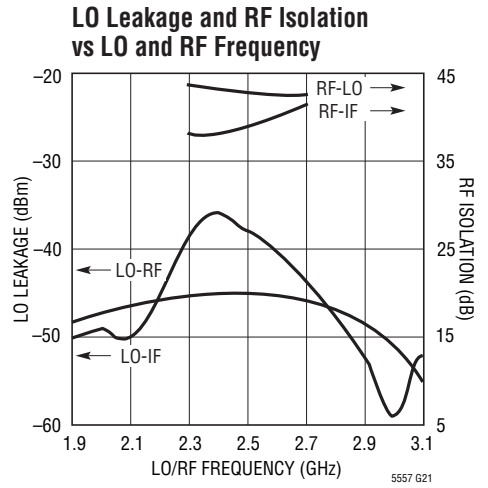
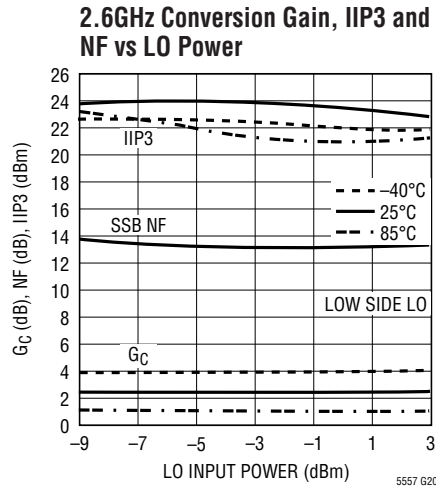
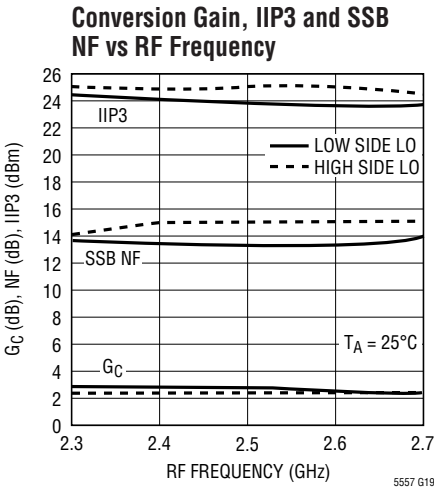

3.3GHz to 3.8GHz application (with external RF matching) 450MHz IF output, $P_{RF} = -6dBm$ (-6dBm/tone for 2-tone IIP3 tests, $\Delta f = 1MHz$), low side LO at -3dBm, unless otherwise noted.

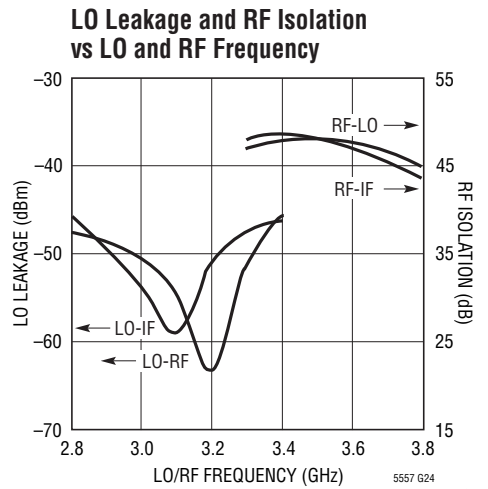
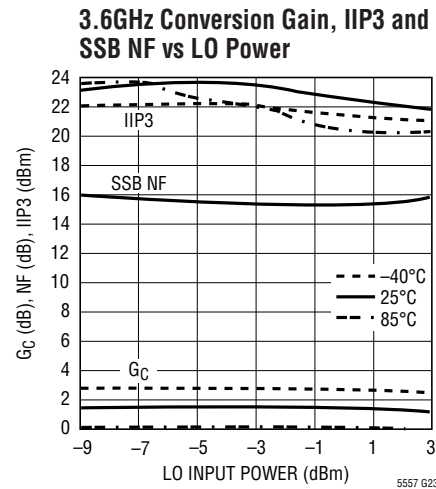
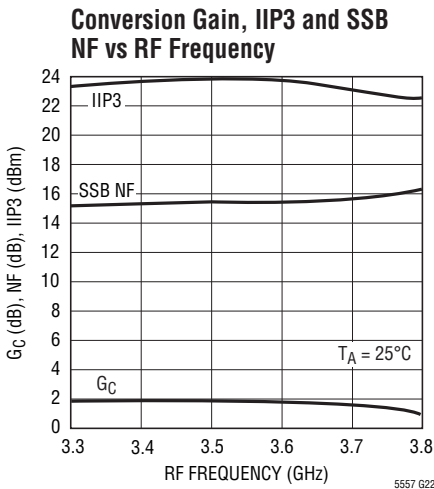

PIN FUNCTIONS

NC (Pins 1, 2, 4, 8, 13, 14, 16): Not Connected Internally. These pins should be grounded on the circuit board for the best LO-to-RF and LO-to-IF isolation.

RF (Pin 3): Single-Ended Input for the RF Signal. This pin is internally connected to the primary side of the RF input transformer, which has low DC resistance to ground. **If the RF source is not DC blocked, then a series blocking capacitor must be used.** The RF input is internally matched from 1.6GHz to 2.3GHz. Operation down to 400MHz or up to 3.8GHz is possible with simple external matching.

EN (Pin 5): Enable Pin. When the input enable voltage is higher than 2.7V, the mixer circuits supplied through Pins 6, 7, 10 and 11 are enabled. When the input voltage is less than 0.3V, all circuits are disabled. Typical input current is 53µA for EN = 3.3V and 0µA when EN = 0V. The EN pin should not be left floating. Under no conditions should the EN pin voltage exceed $V_{CC} + 0.3V$, even at start-up.

V_{CC2} (Pin 6): Power Supply Pin for the Bias Circuits. Typical current consumption is 3.3mA. This pin should be externally connected to the V_{CC1} pin and decoupled with 1000pF and 1µF capacitors.

V_{CC1} (Pin 7): Power Supply Pin for the LO Buffer Circuits. Typical current consumption is 25.1mA. This pin should

be externally connected to the V_{CC2} pin and decoupled with 1000pF and 1µF capacitors.

GND (Pins 9, 12): Ground. These pins are internally connected to the backside ground for improved isolation. They should be connected to the RF ground on the circuit board, although they are not intended to replace the primary grounding through the backside contact of the package.

IF⁻, IF⁺ (Pins 10, 11): Differential Outputs for the IF Signal. An impedance transformation may be required to match the outputs. These pins must be connected to V_{CC} through impedance matching inductors, RF chokes or a transformer center tap. Typical current consumption is 26.6mA each (53.2mA total).

LO (Pin 15): Single-Ended Input for the Local Oscillator Signal. This pin is internally connected to the primary side of the LO transformer, which is internally DC blocked. An external blocking capacitor is not required. The LO input is internally matched from 1GHz to 5GHz. Operation down to 380MHz is possible with simple external matching.

Exposed Pad (Pin 17): Circuit Ground Return for the Entire IC. This must be soldered to the printed circuit board ground plane.

BLOCK DIAGRAM

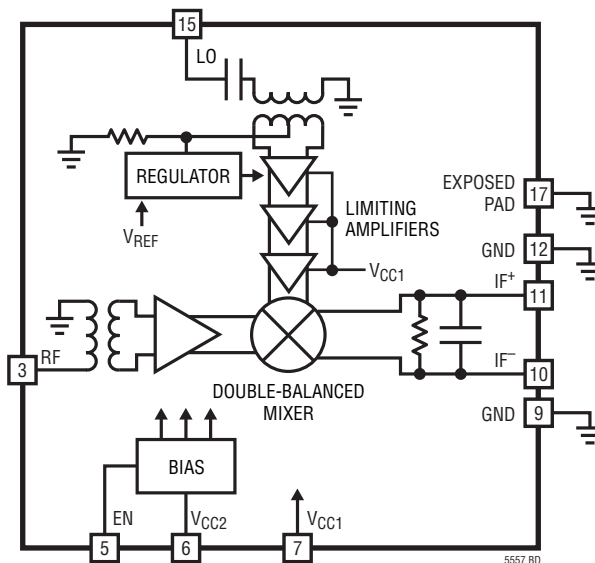

TEST CIRCUITS

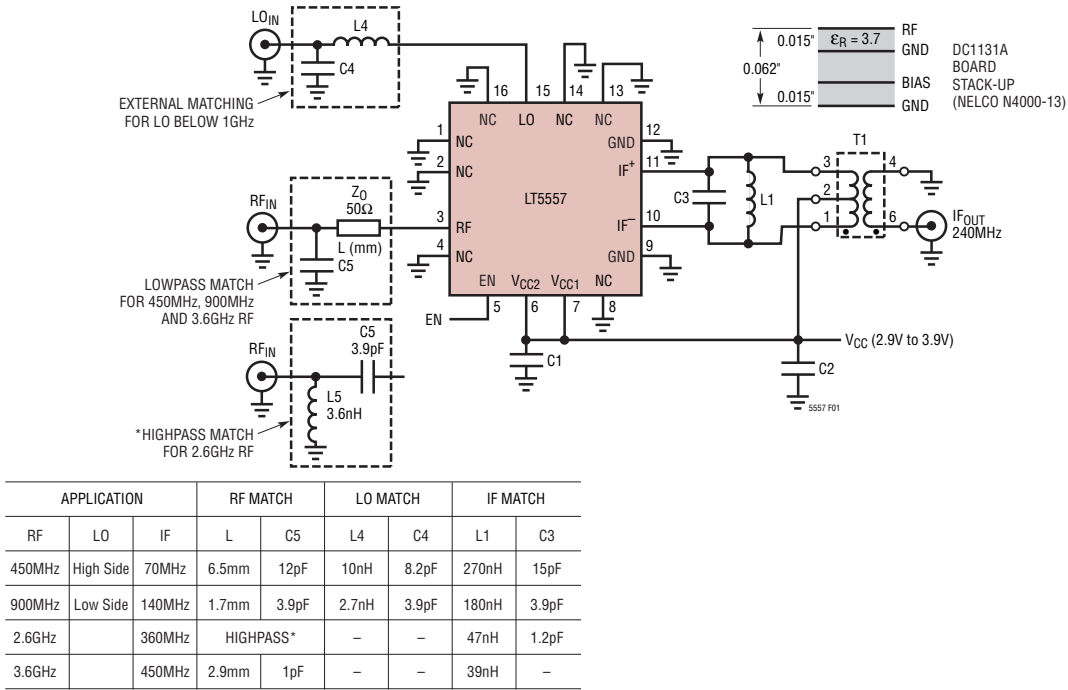

| REF DES | VALUE | SIZE | PART NUMBER | REF DES | VALUE | SIZE | PART NUMBER |
|---------|--------|------|------------------|------------|-------|------|------------------------------|
| C1 | 1000pF | 0402 | AVX 04025C102JAT | L4, C4, C5 | | 0402 | See Applications Information |
| C2 | 1μF | 0603 | AVX 0603ZD105KAT | L1 | 82nH | 0603 | Toko LLQ1608-F82NG |
| C3 | 2.2pF | 0402 | AVX 04025A2R2BAT | T1 | 8:1 | | Mini-Circuits TC8-1+ |

Figure 1. Standard Downmixer Test Schematic—Transformer-Based Bandpass IF Matching (240MHz IF)

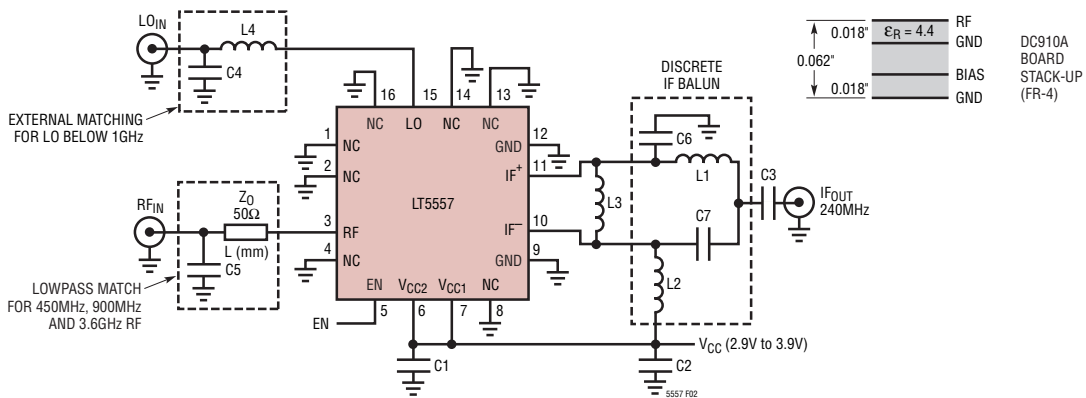

Figure 2. Downmixer Test Schematic—Discrete IF Balun Matching (240MHz IF)

APPLICATIONS INFORMATION

Introduction

The LT5557 consists of a high linearity double-balanced mixer, RF buffer amplifier, high speed limiting LO buffer amplifier and bias/enable circuits. The RF and LO inputs are both single ended. The IF output is differential. Low side or high side LO injection can be used.

Two evaluation circuits are available. The standard evaluation circuit, shown in Figure 1, incorporates transformer-based IF matching and is intended for applications that require the highest dynamic range and the widest IF bandwidth. The second evaluation circuit, shown in Figure 2, replaces the IF transformer with a discrete IF balun for reduced solution cost and size. The discrete IF balun delivers higher conversion gain, but slightly degraded IIP3 and noise figure, and reduced IF bandwidth.

RF Input Port

The mixer's RF input, shown in Figure 3, consists of an integrated transformer and a high linearity differential amplifier. The primary terminals of the transformer are connected to the RF input (Pin 3) and ground. The secondary side of the transformer is internally connected to the amplifier's differential inputs. The DC resistance of the primary is 4.2Ω. **If the RF source has DC voltage present, then a coupling capacitor must be used in series with the RF input pin.**

The RF input is internally matched from 1.6GHz to 2.3GHz, requiring no external components over this frequency range. The input return loss, shown in Figure 4a, is typically 12dB at the band edges. The input match at the lower

band edge can be optimized with a series 3.9pF capacitor at Pin 3, which improves the 1.6GHz return loss to greater than 25dB. Likewise, the 2.3GHz match can be improved to greater than 25dB with a series 1.5nH inductor. A series 2.7nH/2.2pF network will simultaneously optimize the lower and upper band edges and expand the RF input bandwidth to 1.2GHz-2.5GHz. Measured RF input return losses for these three cases are also plotted in Figure 4a.

Alternatively, the input match can be shifted as low as 400MHz or up to 3800MHz by adding a shunt capacitor (C5) to the RF input. A 450MHz input match is realized with C5 = 12pF, located 6.5mm away from Pin 3 on the evaluation board's 50Ω input transmission line. A 900MHz input match requires C5 = 3.9pF, located at 1.7mm. A 3.6GHz input match is realized with C5 = 1pF, located at 2.9mm.

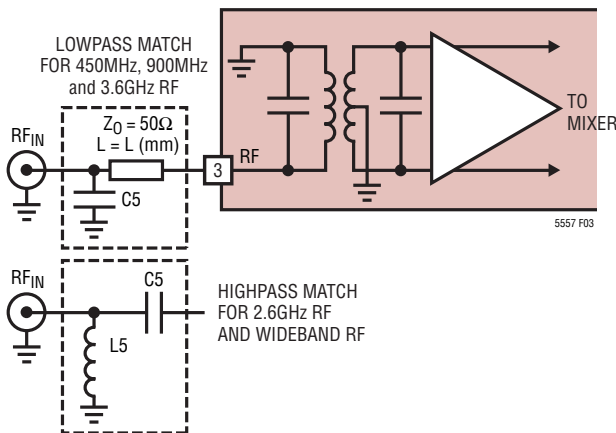
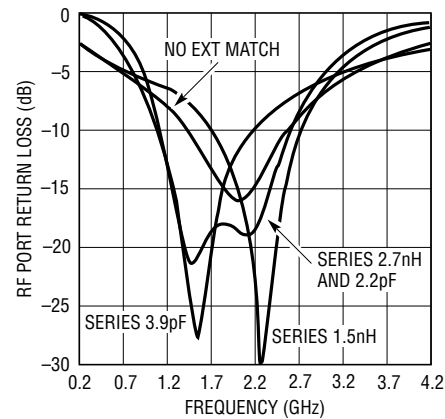
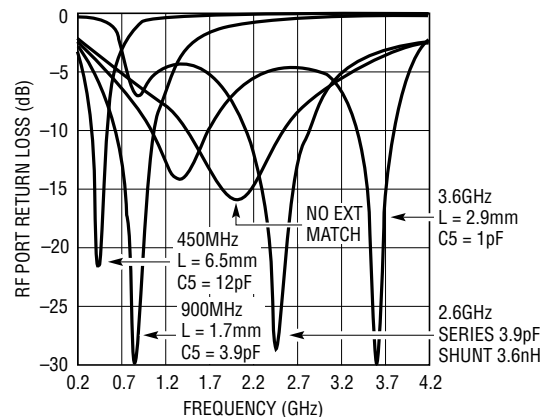

Figure 3. RF Input Schematic



5557 F04a

(4a) Series Reactance Matching



5557 F04b

(4b) Series Shunt Matching

Figure 4. RF Input Return Loss with and without External Matching

APPLICATIONS INFORMATION

This series transmission line/shunt capacitor matching topology allows the LT5557 to be used for multiple frequency standards without circuit board layout modifications. The series transmission line can also be replaced with a series chip inductor for a more compact layout.

Input return losses for the 450MHz, 900MHz, 2.6GHz and 3.6GHz applications are plotted in Figure 4b. The input return loss with no external matching is repeated in Figure 4b for comparison. The 2.6GHz RF input match uses the highpass matching network shown in Figures 1 and 3 with $C5 = 3.9\text{pF}$ and $L5 = 3.6\text{nH}$. The highpass input matching network is also used to create a wideband or dual-band input match. For example, with $C5 = 3.3\text{pF}$ and $L5 = 10\text{nH}$, the RF input is matched from 800MHz to 2.2GHz, with optimum matching in the 800MHz to 1.1GHz and 1.6GHz to 2.2GHz bands, simultaneously.

RF input impedance and S11 versus frequency (with no external matching) are listed in Table 1 and referenced to Pin 3. The S11 data can be used with a microwave circuit simulator to design custom matching networks and simulate board level interfacing to the RF input filter.

Table 1. RF Input Impedance vs Frequency

| FREQUENCY (MHz) | INPUT IMPEDANCE | S11 | |
|-----------------|-----------------|-------|--------|
| | | MAG | ANGLE |
| 50 | $4.6 + j2.3$ | 0.832 | 174.7 |
| 300 | $9.1 + j11.2$ | 0.706 | 153.8 |
| 450 | $12.0 + j14.5$ | 0.639 | 145.8 |
| 600 | $14.7 + j17.4$ | 0.588 | 138.7 |
| 900 | $20.5 + j23.3$ | 0.506 | 123.4 |
| 1300 | $34.4 + j30.3$ | 0.380 | 97.5 |
| 1700 | $59.6 + j23.8$ | 0.229 | 55.8 |
| 1950 | $69.2 + j2.8$ | 0.163 | 6.9 |
| 2200 | $59.2 - j18.1$ | 0.184 | -53.5 |
| 2450 | $41.5 - j24.5$ | 0.274 | -94.2 |
| 2700 | $28.3 - j21.3$ | 0.374 | -120.3 |
| 3000 | $19.0 - j13.5$ | 0.481 | -145.5 |
| 3300 | $13.9 - j5.1$ | 0.568 | -167.3 |
| 3600 | $10.8 + j3.4$ | 0.645 | 171.9 |
| 3900 | $9.4 + j12.3$ | 0.700 | 151.4 |

LO Input Port

The mixer's LO input, shown in Figure 5, consists of an integrated transformer and high speed limiting differential amplifiers. The amplifiers are designed to precisely drive the mixer for the highest linearity and the lowest noise figure. An internal DC blocking capacitor in series with the transformer's primary eliminates the need for an external blocking capacitor.

The LO input is internally matched from 1GHz to 5GHz. The input match can be shifted down, as low as 750MHz, with a single shunt capacitor ($C4$) on Pin 15. One example is plotted in Figure 6 where $C4 = 2.7\text{pF}$ produces a 750MHz to 1GHz match.

LO input matching below 750MHz requires the series inductor ($L4$)/shunt capacitor ($C4$) network shown in Figure 5. Two examples are plotted in Figure 6, where $L4 = 2.7\text{nH}/C4 = 3.9\text{pF}$ produces a 650MHz to 830MHz match and $L4 = 10\text{nH}/C4 = 8.2\text{pF}$ produces a 460MHz to 560MHz match. The evaluation boards do not include pads for $L4$, so the circuit trace needs to be cut near Pin 15 to insert $L4$. A low cost multilayer chip inductor is adequate for $L4$.

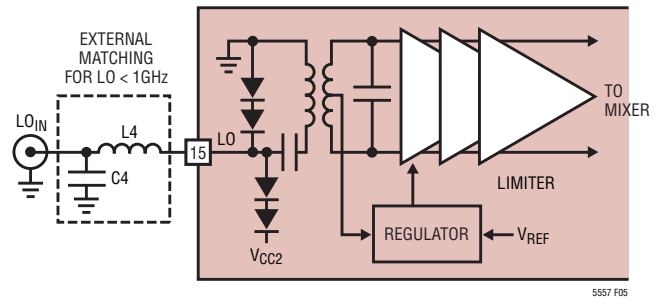

Figure 5. LO Input Schematic

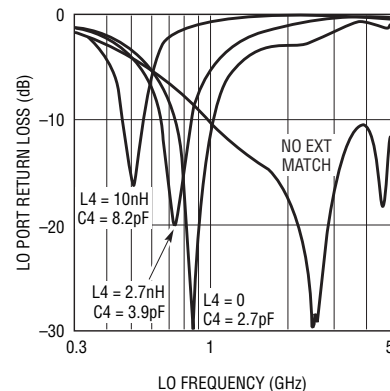

Figure 6. LO Input Return Loss

APPLICATIONS INFORMATION

The optimum LO drive is -3dBm for LO frequencies above 1.2GHz , although the amplifiers are designed to accommodate several dB of LO input power variation without significant mixer performance variation. Below 1.2GHz , 0dBm LO drive is recommended for optimum noise figure, although -3dBm will still deliver good conversion gain and linearity.

Custom matching networks can be designed using the port impedance data listed in Table 2. This data is referenced to the LO pin with no external matching.

Table 2. LO Input Impedance vs Frequency

| FREQUENCY (MHz) | INPUT IMPEDANCE | S11 | |
|-----------------|-----------------|-------|----------|
| | | MAG | ANGLE |
| 50 | $10.0 - j326$ | 0.991 | -17.4 |
| 300 | $8.5 - j41.9$ | 0.820 | -99.2 |
| 500 | $11.8 - j10.1$ | 0.632 | -155.9 |
| 700 | $18.8 + j10.9$ | 0.474 | 151.8 |
| 900 | $35.0 + j27.4$ | 0.350 | 100.8 |
| 1200 | $72.9 + j19.3$ | 0.241 | 31.3 |
| 1500 | $70.0 - j12.6$ | 0.196 | -26.1 |
| 1800 | $55.0 - j17.0$ | 0.167 | -64.3 |
| 2200 | $47.8 - j9.7$ | 0.102 | -97.2 |
| 2600 | $53.6 - j1.9$ | 0.039 | -26.8 |
| 3000 | $66.7 + j0.7$ | 0.143 | 2.1 |
| 3500 | $82.1 - j13.9$ | 0.263 | -17.4 |
| 4000 | $69.0 - j30.1$ | 0.290 | -43.5 |
| 4500 | $43.7 - j13.2$ | 0.154 | -107.5 |
| 5000 | $36.4 + j19.8$ | 0.271 | 111.6 |

IF Output Port

The IF outputs, IF^+ and IF^- , are internally connected to the collectors of the mixer switching transistors (see Figure 7). Both pins must be biased at the supply voltage, which can be applied through the center tap of a transformer or through matching inductors. Each IF pin draws 26.6mA of supply current (53.2mA total). For optimum single-ended performance, these differential outputs should be combined externally through an IF transformer or a discrete IF balun circuit. The standard evaluation board (see Figure 1) includes an IF transformer for impedance transformation and differential to single-ended transformation. A second evaluation board (see Figure 2) realizes the same functionality with a discrete IF balun circuit.

The IF output impedance can be modeled as 560Ω in parallel with 2.6pF at low frequencies. An equivalent small-signal model (including bondwire inductance) is shown in Figure 8. Frequency-dependent differential IF output impedance is listed in Table 3. This data is referenced to the package pins (with no external components) and includes the effects of IC and package parasitics. The IF output can be matched for IF frequencies as low as several kHz or as high as 600MHz .

Table 3. IF Output Impedance vs Frequency

| FREQUENCY (MHz) | DIFFERENTIAL OUTPUT IMPEDANCE ($R_{\text{IF}} \parallel X_{\text{IF}}$) |
|-----------------|---------------------------------------------------------------------------|
| 1 | $560 \parallel -j63.7\text{k}$ (2.6pF) |
| 70 | $556 \parallel -j870$ (2.6pF) |
| 140 | $551 \parallel -j440$ (2.6pF) |
| 190 | $523 \parallel -j320$ (2.6pF) |
| 240 | $529 \parallel -j254$ (2.6pF) |
| 300 | $509 \parallel -j200$ (2.66pF) |
| 360 | $483 \parallel -j163$ (2.7pF) |
| 450 | $448 \parallel -j125$ (2.83pF) |
| 600 | $396 \parallel -j92$ (2.88pF) |

Two methods of differential to single-ended IF matching are described:

- Transformer-based bandpass
- Discrete IF balun

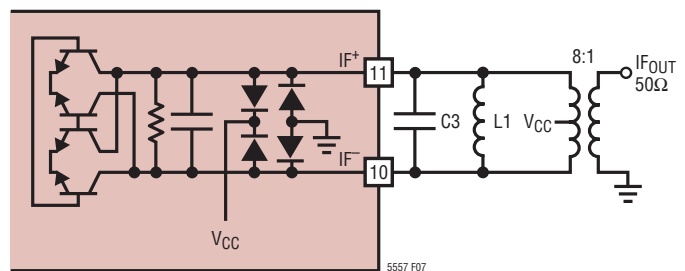

Figure 7. IF Output with External Matching

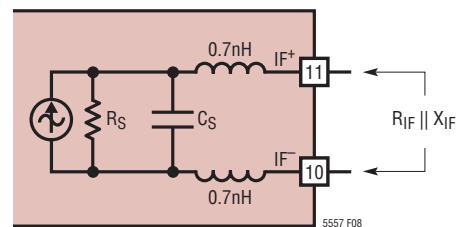

Figure 8. IF Output Small-Signal Model

5557fc

APPLICATIONS INFORMATION

Transformer-Based Bandpass IF Matching

The standard evaluation board (shown in Figure 1) uses an L-C bandpass IF matching network, with an 8:1 transformer connected across the IF pins. The L-C network maximizes mixer performance at the desired IF frequency. The transformer performs impedance transformation and provides a single-ended 50Ω output.

The value of L1 is calculated as:

$$L1 = 1/[(2\pi f_{IF})^2 \cdot C_{IF}]$$

where C_{IF} is the sum of C3 and the internal IF capacitance (listed in Table 3). The value of C3 is selected such that L1 falls on a standard value, while satisfying the desired IF bandwidth. The IF bandwidth can be estimated as:

$$BW_{IF} = 1/(2\pi R_{EFF} C_{IF})$$

where R_{EFF} , the effective IF resistance when loaded with the transformer and inductor loss, is approximately 200Ω.

Below 40MHz, the magnitude of the internal IF reactance is relatively high compared to the internal resistance. In this case, L1 (and C3) can be eliminated, and the 8:1 transformer alone is adequate for IF matching.

The LT5557 was characterized with IF frequencies of 70MHz, 140MHz, 240MHz, 360MHz and 450MHz. The values of L1 and C3 used for these frequencies are tabulated in Figure 1 and repeated in Figure 9. In all cases, L1 is a high-Q 0603 wire-wound chip inductor, for highest conversion gain. Low cost multilayer chip inductors can be substituted, with a slight reduction in conversion gain. The measured IF output return losses are plotted in Figure 9.

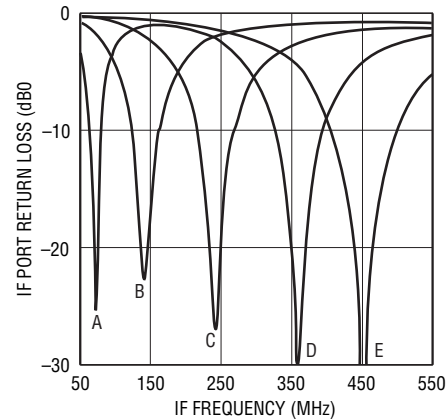

5557 609
 A: 70MHz, L1 = 270nH, C3 = 15pF
 B: 140MHz, L1 = 180nH, C3 = 3.9pF
 C: 240MHz, L1 = 82nH, C3 = 2.2pF
 D: 360MHz, L1 = 47nH, C3 = 1.2pF
 E: 450MHz, L1 = 39nH, C3 = 0pF

Figure 9. IF Output Return Loss with Transformer-Based Bandpass Matching

Discrete IF Balun Matching

For many applications, it is possible to replace the IF transformer with the discrete IF balun shown in Figure 2. The values of L1, L2, C6 and C7 are calculated to realize a 180 degree phase shift at the desired IF frequency and provide a 50Ω single-ended output, using the following equations. Inductor L3 is calculated to cancel the internal 2.6pF capacitance. L3 also supplies bias voltage to the IF⁺ pin. Low cost multilayer chip inductors are adequate for L1, L2 and L3. C3 is a DC blocking capacitor.

$$L1, L2 = \frac{\sqrt{R_{IF} \cdot R_{OUT}}}{\omega_{IF}}$$

$$C6, C7 = \frac{1}{\omega_{IF} \cdot \sqrt{R_{IF} \cdot R_{OUT}}}$$

$$L3 = \frac{|X_{IF}|}{\omega_{IF}}$$

APPLICATIONS INFORMATION

These equations give a good starting point, but it is usually necessary to adjust the component values after building and testing the circuit. The final solution can be achieved with less iteration by considering the parasitics of L3 in the above calculations. Specifically, the effective parallel resistance of L3 (calculated from the manufacturer's Q data) will reduce the value of R_{IF} , which in turn influences the calculated values of $L1 (= L2)$ and $C6 (= C7)$. Also, the effective parallel capacitance of L3 (taken from the manufacturer's SRF data) must be considered, since it is in parallel with X_{IF} (from Table 3). Frequently, the calculated value for L1 does not fall on a standard value for the desired IF. In this case, a simple solution is to load the IF output with a high value external chip resistor in parallel with L3, which reduces the value of R_{IF} , until L1 is a standard value.

Discrete IF balun element values for four common IF frequencies (190MHz, 240MHz, 360MHz and 450MHz) are listed in Table 4. The 190MHz application circuit uses a 3.3k resistor in parallel with L3 as previously described. The corresponding measured IF output return losses are shown in Figure 10. Typical conversion gain, IIP3 and LO-IF leakage, versus RF input frequency for all four examples is shown in Figure 11. Typical conversion gain, IIP3 and noise figure versus IF output frequency is shown in Figure 12.

Compared to the transformer-based IF matching technique, this network delivers approximately 1dB higher conversion gain (since the IF transformer loss is eliminated), though noise figure and IIP3 are degraded slightly. The most significant performance difference, as shown in Figure 12, is the limited IF bandwidth available from the discrete approach. For low IF frequencies, the absolute bandwidth is small, whereas higher IF frequencies offer wider bandwidth.

Table 5. Discrete IF Balun Element Values ($R_{OUT} = 50\Omega$)

| IF FREQUENCY (MHz) | L1, L2 | C6, C7 | L3 |
|--------------------|--------|--------|------------------------|
| 190 | 120nH | 6.0pF | 270nH 3.3k Ω |
| 240 | 100nH | 4.7pF | 150nH |
| 360 | 56nH | 3.0pF | 82nH |
| 450 | 47nH | 2.2pF | 47nH |

Differential IF Output Matching

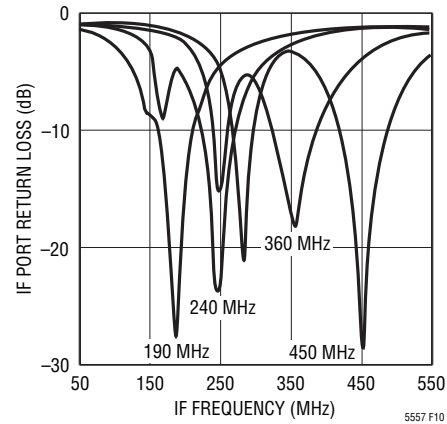

Figure 10. IF Output Return Losses with Discrete Balun Matching

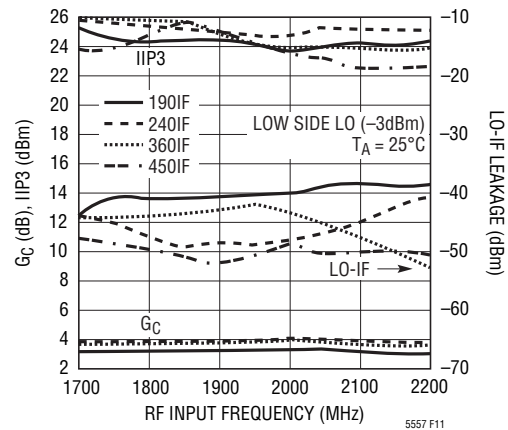

Figure 11. Conversion Gain, IIP3 and LO-IF Leakage vs RF Input Frequency and IF Output Frequency (in MHz) Using Discrete IF Balun Matching

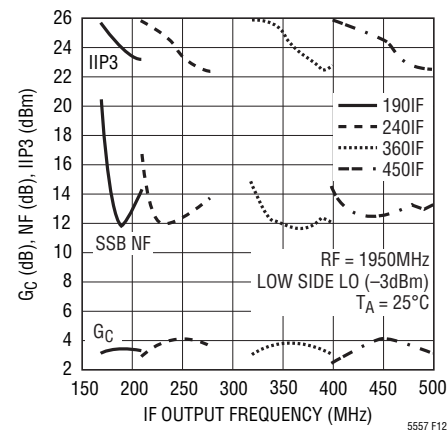

Figure 12. Conversion Gain, IIP3 and SSB NF vs IF Output Frequency Using Discrete IF Balun Matching

APPLICATIONS INFORMATION

For fully differential IF architectures, the mixer's IF outputs can be matched directly into a SAW filter or IF amplifier, thus eliminating the IF transformer. One example is shown in Figure 13, where the mixer's 500Ω differential output resistance is matched into a 100Ω differential SAW filter using the tapped-capacitor technique. Inductors L1 and L2 form the inductive portion of the matching network, cancel the internal 2.6pF capacitance, and supply DC bias current to the mixer core. Capacitors C6 through C9 are the capacitive portion of the matching, and perform the impedance step-down.

The calculations for tapped-capacitor matching are cov-

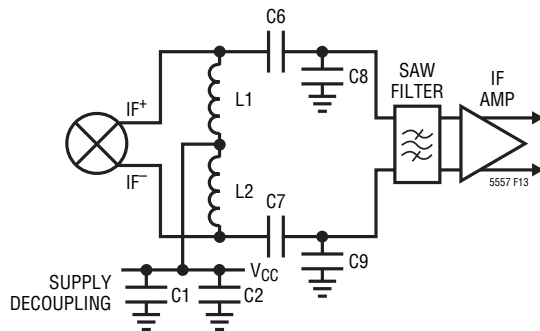

Figure 13. Differential IF Matching Using the Tapped-Capacitor Technique

ered in the literature, and are not repeated here. Other differential matching options include lowpass, highpass and bandpass. The choice depends on the system performance goals, IF frequency, IF bandwidth and filter (or amplifier) input impedance. Contact the factory for applications assistance.

Enable Interface

Figure 14 shows a simplified schematic of the EN pin interface. The voltage necessary to turn on the LT5557 is 2.7V. To disable the chip, the enable voltage must be less than 0.3V. If the EN pin is allowed to float, the chip will tend to remain in its last operating state. Thus, it is not recommended that the enable function be used in this manner. If the shutdown function is not required, then the EN pin should be connected directly to V_{CC}.

The voltage at the EN pin should never exceed the power supply voltage (V_{CC}) by more than 0.3V. If this should occur, the supply current could be sourced through the EN pin ESD diode, potentially damaging the IC.

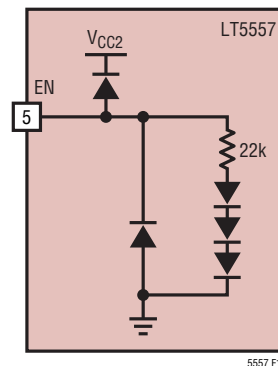

Figure 14. Enable Input Circuit

APPLICATIONS INFORMATION

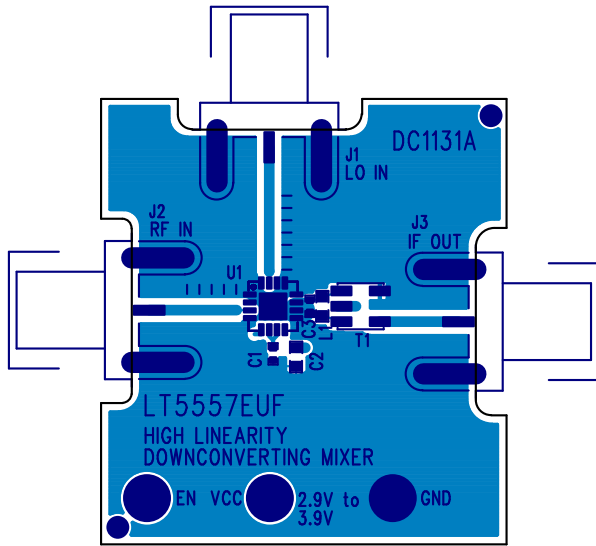

Figure 15. Standard Evaluation Board Layout (DC1131A)

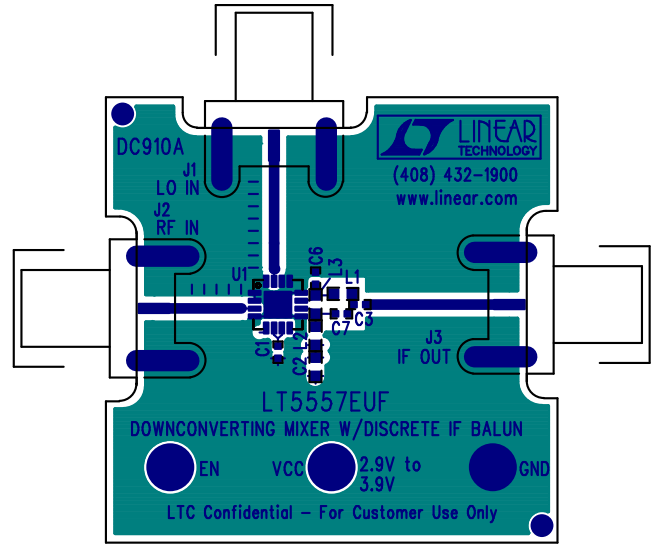
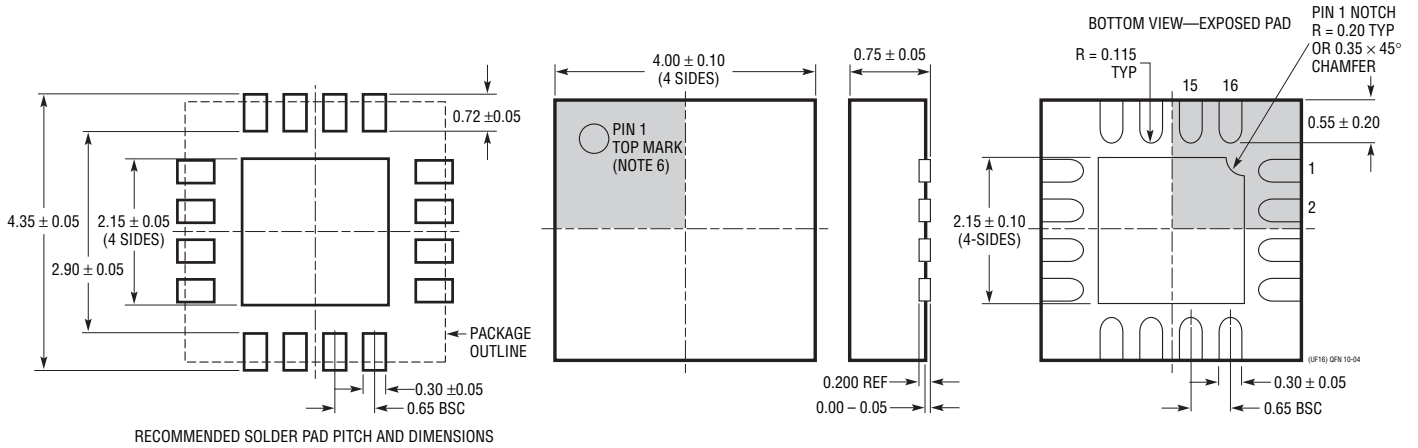

Figure 16. Discrete IF Evaluation Board Layout (DC910A)

PACKAGE DESCRIPTION

UF Package
16-Lead Plastic QFN (4mm × 4mm)
 (Reference LTC DWG # 05-08-1692)



- NOTE:
1. DRAWING CONFORMS TO JEDEC PACKAGE OUTLINE MO-220 VARIATION (WGGC)
 2. DRAWING NOT TO SCALE
 3. ALL DIMENSIONS ARE IN MILLIMETERS
 4. DIMENSIONS OF EXPOSED PAD ON BOTTOM OF PACKAGE DO NOT INCLUDE MOLD FLASH. MOLD FLASH, IF PRESENT, SHALL NOT EXCEED 0.15mm ON ANY SIDE

5. EXPOSED PAD SHALL BE SOLDER PLATED
6. SHADED AREA IS ONLY A REFERENCE FOR PIN 1 LOCATION ON THE TOP AND BOTTOM OF PACKAGE

REVISION HISTORY (Revision history begins at Rev C)

| REV | DATE | DESCRIPTION | PAGE NUMBER |
|-----|------|-------------------------------------------------------------------------------------------------------------------------------|-------------|
| C | 6/11 | Revised title and Features | 1 |
| | | Revised Absolute Maximum Ratings, Pin Configuration, DC Electrical Characteristics, AC Electrical Characteristics, and Note 3 | 2, 3 |
| | | Updated Related Parts list | 18 |

RELATED PARTS

| PART NUMBER | DESCRIPTION | COMMENTS |
|--------------------------------------|-----------------------------------------------------------------------------|--------------------------------------------------------------------------------------------------------------------|
| Infrastructure | | |
| LT5512 | 1kHz to 3GHz High Signal Level Active Mixer | 20dBm IIP3 from 30MHz to 900MHz, Integrated LO Buffer, HF/VHF/UHF Optimized |
| LT5514 | Ultralow Distortion, IF Amplifier/ADC Driver with Digitally Controlled Gain | 850MHz Bandwidth, 47dBm OIP3 at 100MHz, 10.5dB to 33dB Gain Control Range |
| LT5515 | 1.5GHz to 2.5GHz Direct Conversion Quadrature Demodulator | 20dBm IIP3, Integrated LO Quadrature Generator |
| LT5516 | 0.8GHz to 1.5GHz Direct Conversion Quadrature Demodulator | 21.5dBm IIP3, Integrated LO Quadrature Generator |
| LT5517 | 40MHz to 900MHz Quadrature Demodulator | 21dBm IIP3, Integrated LO Quadrature Generator |
| LT5519 | 0.7GHz to 1.4GHz High Linearity Upconverting Mixer | 17.1dBm IIP3 at 1GHz, Integrated RF Output Transformer with 50Ω Matching, Single-Ended LO and RF Ports Operation |
| LT5520 | 1.3GHz to 2.3GHz High Linearity Upconverting Mixer | 15.9dBm IIP3 at 1.9GHz, Integrated RF Output Transformer with 50Ω Matching, Single-Ended LO and RF Ports Operation |
| LT5521 | 10MHz to 3700MHz High Linearity Upconverting Mixer | 24.2dBm IIP3 at 1.95GHz, NF = 12.5dB, 3.15V to 5.25V Supply, Single-Ended LO Port Operation |
| LT5522 | 400MHz to 2.7GHz High Signal Level Downconverting Mixer | 4.5V to 5.25V Supply, 25dBm IIP3 at 900MHz, NF = 12.5dB, 50Ω Single-Ended RF and LO Ports |
| LT5525 | High Linearity, Low Power Downconverting Mixer | Single-Ended 50Ω RF and LO Ports, 17.6dBm IIP3 at 1900MHz, I _{CC} = 28mA |
| LT5526 | High Linearity, Low Power Downconverting Mixer | 3V to 5.3V Supply, 16.5dBm IIP3, 100kHz to 2GHz RF, NF = 11dB, I _{CC} = 28mA, -65dBm LO-RF Leakage |
| LT5527 | 400MHz to 3.7GHz, 5V High Signal Level Downconverting Mixer | 23.5dBm IIP3 at 1.9GHz, NF = 12.5dB, Single-Ended RF and LO Ports |
| LT5528 | 1.5GHz to 2.4GHz High Linearity Direct I/Q Modulator | 21.8dBm OIP3 at 2GHz, -159dBm/Hz Noise Floor, 50Ω Interface at All Ports |
| LT5568 | 600MHz to 1.2GHz High Linearity Direct I/Q Modulator | 22.9dBm OIP3, -160.3dBm/Hz Noise Floor, -46dBc Image Rejection, -43dBm Carrier Leakage |
| LTC®5569 | 300MHz to 4GHz 3.3V Dual Active Downconverting Mixer | 2dB Gain, 26.8dBm IIP3, 11.7dB NF at 1950MHz |
| RF Power Detectors | | |
| LTC5505 | RF Peak Detectors with >40dB Dynamic Range | 300MHz to 3GHz, Temperature Compensated, -32dBm to 12dBm |
| LTC5507 | 100kHz to 1000MHz RF Peak Power Detector | 100kHz to 1GHz, Temperature Compensated, -34dBm to 14dBm |
| LTC5508 | 300MHz to 7GHz RF Peak Power Detector | 44dB Dynamic Range, Temperature Compensated, SC70 Package, -32dBm to 12dBm |
| LTC5509 | 300MHz to 3GHz RF Peak Power Detector | 36dB Dynamic Range, Low Power Consumption, SC70 Package, -30dBm to 6dBm |
| LTC5530 | 300MHz to 7GHz Precision RF Peak Power Detector | Precision V _{OUT} Offset Control, Shutdown, Adjustable Gain, -32dBm to 10dBm |
| LTC5531 | 300MHz to 7GHz Precision RF Peak Power Detector | Precision V _{OUT} Offset Control, Shutdown, Adjustable Offset, -32dBm to 10dBm |
| LTC5532 | 300MHz to 7GHz Precision RF Peak Power Detector | Precision V _{OUT} Offset Control, Adjustable Gain and Offset, ±35mV Offset Voltage Tolerance |
| LTC5533 | 300MHz to 11GHz Dual Precision RF Peak Detector | -32dBm to 12dBm, Adjustable Offset, 45dB Channel-to-Channel Isolation |
| LT5534 | 50MHz to 3GHz RF Log Detector with 60dB Dynamic Range | ±1dB Output Variation Over Temperature, 38ns Response Time |
| LTC5536 | Precision 600MHz to 7GHz RF Peak Detector with Fast Comparator Output | 25ns Response Time, Comparator Reference Input, Latch Enable Input, -26dBm to +12dBm Input Range |
| LT5537 | 90dB Dynamic Range RF Log Detector | LF to 1GHz, -79dBm to 12dBm, Very Low Tempco |
| Low Voltage RF Building Block | | |
| LT5546 | 500MHz Quadrature Demodulator with VGA and 17MHz Baseband Bandwidth | 17MHz Baseband Bandwidth, 40MHz to 500MHz IF, 1.8V to 5.25V Supply, -7dB to 56dB Linear Power Gain |

5557fc