

# MAX16936

## 36V, 220kHz to 2.2MHz Step-Down Converter with 28 $\mu$ A Quiescent Current

### General Description

The MAX16936 is a 2.5A current-mode step-down converter with integrated high-side and low-side MOSFETs designed to operate with an external Schottky diode for better efficiency. The low-side MOSFET enables fixed-frequency forced-PWM (FPWM) operation under light-load applications. The device operates with input voltages from 3.5V to 36V, while using only 28 $\mu$ A quiescent current at no load. The switching frequency is resistor programmable from 220kHz to 2.2MHz and can be synchronized to an external clock. The MAX16936's output voltage is available as 5V/3.3V fixed or adjustable from 1V to 10V. The wide input voltage range along with its ability to operate at 98% duty cycle during undervoltage transients make the MAX16936 ideal for automotive and industrial applications.

Under light-load applications, the FSYNC logic input allows the MAX16936 to either operate in skip mode for reduced current consumption or fixed-frequency FPWM mode to eliminate frequency variation to minimize EMI. Fixed-frequency FPWM mode is extremely useful for power supplies designed for RF transceivers where tight emission control is necessary. Protection features include cycle-by-cycle current limit and thermal shutdown with automatic recovery. Additional features include a power-good monitor to ease power-supply sequencing and a 180° out-of-phase clock output relative to the internal oscillator at SYNCOUT to create cascaded power supplies with multiple MAX16936s.

The MAX16936 operates over the -40°C to +125°C automotive temperature range and is available in 16-pin TSSOP-EP and 5mm x 5mm, 16-pin TQFN-EP packages.

**Ordering Information/Selector Guide** appears at end of data sheet.

**Typical Application Circuit** appears at end of data sheet.

### Features

- ◆ Wide 3.5V to 36V Input Voltage Range
- ◆ 42V Load Dump Protection
- ◆ Enhanced Current-Mode Control Architecture
- ◆ Fixed Output Voltage with  $\pm 2\%$  Accuracy (5V/3.3V) or Externally Resistor Adjustable (1V to 10V)
- ◆ 220kHz to 2.2MHz Switching Frequency with Three Operation Modes
  - ◇ 28 $\mu$ A Ultra-Low Quiescent Current Skip Mode
  - ◇ Forced Fixed-Frequency Operation
  - ◇ External Frequency Synchronization
- ◆ Spread-Spectrum Frequency Modulation
- ◆ Automatic LX Slew Rate Adjustment for Optimum Efficiency Across Operating Frequency Range
- ◆ 180° Out-of-Phase Clock Output at SYNCOUT
- ◆ Low-BOM-Count Current-Mode Control Architecture
- ◆ Power-Good Output
- ◆ Enable Input Compatible from 3.3V Logic Level to 42V
- ◆ Thermal Shutdown Protection
- ◆ -40°C to +125°C Automotive Temperature Range
- ◆ AEC-Q100 Qualified

### Applications

Point-of-Load Applications  
Distributed DC Power Systems  
Navigation and Radio Head Units

For related parts and recommended products to use with this part, refer to: [www.maximintegrated.com/MAX16936.related](http://www.maximintegrated.com/MAX16936.related)

For pricing, delivery, and ordering information, please contact Maxim Direct at 1-888-629-4642, or visit Maxim Integrated's website at [www.maximintegrated.com](http://www.maximintegrated.com).

19-6626; Rev 5; 3/14

# MAX16936

## 36V, 220kHz to 2.2MHz Step-Down Converter with 28µA Quiescent Current

### ABSOLUTE MAXIMUM RATINGS

SUP, SUPSW, LX, EN to PGND .....	-0.3V to +42V	Output Short-Circuit Duration .....	Continuous
SUP to SUPSW .....	-0.3V to +0.3V	Continuous Power Dissipation (T <sub>A</sub> = +70°C)*	
BIAS to AGND .....	-0.3V to +6V	TSSOP (derate 26.1mw/°C above +70°C) .....	2088.8mW
SYNCOUT, FOSC, COMP, FSYNC,		TQFN (derate 28.6mw/°C above +70°C) .....	2285.7mW
PGOOD, FB to AGND .....	-0.3V to (V <sub>BIAS</sub> + 0.3V)	Operating Temperature Range .....	-40°C to +125°C
OUT to PGND .....	-0.3V to +12V	Junction Temperature .....	+150°C
BST to LX .....	-0.3V to +6V	Storage Temperature Range .....	-65°C to +150°C
AGND to PGND .....	-0.3V to + 0.3V	Lead Temperature (soldering, 10s) .....	+300°C
LX Continuous RMS Current .....	3A	Soldering Temperature (reflow) .....	+260°C

\*As per JEDEC51 standard (multilayer board).

Stresses beyond those listed under "Absolute Maximum Ratings" may cause permanent damage to the device. These are stress ratings only, and functional operation of the device at these or any other conditions beyond those indicated in the operational sections of the specifications is not implied. Exposure to absolute maximum rating conditions for extended periods may affect device reliability.

### PACKAGE THERMAL CHARACTERISTICS (Note 1)

TSSOP	Junction-to-Ambient Thermal Resistance (θ <sub>JA</sub> ) .....	38.3°C/W	TQFN	Junction-to-Ambient Thermal Resistance (θ <sub>JA</sub> ) .....	35°C/W
	Junction-to-Case Thermal Resistance (θ <sub>JC</sub> ) .....	3°C/W		Junction-to-Case Thermal Resistance (θ <sub>JC</sub> ) .....	2.7°C/W

**Note 1:** Package thermal resistances were obtained using the method described in JEDEC specification JESD51-7, using a four-layer board. For detailed information on package thermal considerations, refer to [www.maximintegrated.com/thermal-tutorial](http://www.maximintegrated.com/thermal-tutorial).

### ELECTRICAL CHARACTERISTICS

(V<sub>SUP</sub> = V<sub>SUPSW</sub> = 14V, V<sub>EN</sub> = 14V, L1 = 2.2µH, C<sub>IN</sub> = 4.7µF, C<sub>OUT</sub> = 22µF, C<sub>BIAS</sub> = 1µF, C<sub>BST</sub> = 0.1µF, R<sub>FOSC</sub> = 12kΩ, T<sub>A</sub> = T<sub>J</sub> = -40°C to +125°C, unless otherwise noted. Typical values are at T<sub>A</sub> = +25°C.)

PARAMETER	SYMBOL	CONDITIONS	MIN	TYP	MAX	UNITS
Supply Voltage	VSUP, VSUPSW		3.5		36	V
Load Dump Event Supply Voltage	VSUP_LD	tLD < 1s			42	V
Supply Current	ISUP_STANDBY	Standby mode, no load, VOUT = 5V, VFSYNC = 0V		28	40	µA
Shutdown Supply Current	ISHDN	VEN = 0V		5	8	µA
BIAS Regulator Voltage	VBIAS	VSUP = VSUPSW = 6V to 42V, IBIAS = 0 to 10mA	4.7	5	5.4	V
BIAS Undervoltage Lockout	VUVBIAS	VBIAS rising	2.95	3.15	3.40	V
BIAS Undervoltage Lockout Hysteresis				450	650	mV
Thermal Shutdown Threshold				+175		°C
Thermal Shutdown Threshold Hysteresis				15		°C

# MAX16936

## 36V, 220kHz to 2.2MHz Step-Down Converter with 28μA Quiescent Current

### ELECTRICAL CHARACTERISTICS (continued)

( $V_{SUP} = V_{SUPSW} = 14V$ ,  $V_{EN} = 14V$ ,  $L1 = 2.2\mu H$ ,  $C_{IN} = 4.7\mu F$ ,  $C_{OUT} = 22\mu F$ ,  $C_{BIAS} = 1\mu F$ ,  $C_{BST} = 0.1\mu F$ ,  $R_{FOSC} = 12k\Omega$ ,  $T_A = T_J = -40^\circ C$  to  $+125^\circ C$ , unless otherwise noted. Typical values are at  $T_A = +25^\circ C$ .)

PARAMETER	SYMBOL	CONDITIONS	MIN	TYP	MAX	UNITS
<b>OUTPUT VOLTAGE (OUT)</b>						
FPWM Mode Output Voltage (Note 2)	VOUT_5V	VFB = VBIAS, $6V < V_{SUPSW} < 36V$ , MAX16936____A/V+, fixed-frequency mode	4.9	5	5.1	V
	VOUT_3.3V	VFB = VBIAS, $6V < V_{SUPSW} < 36V$ , MAX16936____B/V+, fixed-frequency mode	3.234	3.3	3.366	
Skip Mode Output Voltage (Note 3)	VOUT_5V	No load, VFB = VBIAS, MAX16936____A/V+, skip mode	4.9	5	5.15	V
	VOUT_3.3V	VFB = VBIAS, $6V < V_{SUPSW} < 36V$ , MAX16936____B/V+, skip mode	3.234	3.3	3.34	
Load Regulation		VFB = VBIAS, $300mA < I_{LOAD} < 2.5A$		0.5		%
Line Regulation		VFB = VBIAS, $6V < V_{SUPSW} < 36V$		0.02		%/V
BST Input Current	IBST_ON	High-side MOSFET on, $V_{BST} - V_{LX} = 5V$	1	1.5	2	mA
	IBST_OFF	High-side MOSFET off, $V_{BST} - V_{LX} = 5V$ , $T_A = +25^\circ C$			5	μA
LX Current Limit	ILX	Peak inductor current	3	3.75	4.5	A
LX Rise Time		$R_{FOSC} = 12k\Omega$		4		ns
Skip Mode Current Threshold	ISKIP_TH	$T_A = +25^\circ C$	150	300	400	mA
Spread Spectrum		Spread spectrum enabled		fOSC ±6%		
High-Side Switch On-Resistance	RON_H	$ILX = 1A$ , $V_{BIAS} = 5V$		100	220	mΩ
High-Side Switch Leakage Current		High-side MOSFET off, $V_{SUP} = 36V$ , $V_{LX} = 0V$ , $T_A = +25^\circ C$		1	3	μA
Low-Side Switch On-Resistance	RON_L	$ILX = 0.2A$ , $V_{BIAS} = 5V$		1.5	3	Ω
Low-Side Switch Leakage Current		$V_{LX} = 36V$ , $T_A = +25^\circ C$			1	μA
<b>TRANSCONDUCTANCE AMPLIFIER (COMP)</b>						
FB Input Current	IFB			20	100	nA
FB Regulation Voltage	VFB	FB connected to an external resistor divider, $6V < V_{SUPSW} < 36V$ (Note 4)	0.99	1.0	1.015	V
FB Line Regulation	ΔVLINE	$6V < V_{SUPSW} < 36V$		0.02		%/V
Transconductance (from FB to COMP)	gm	VFB = 1V, $V_{BIAS} = 5V$		700		μS
Minimum On-Time	tON_MIN	(Note 3)		80		ns
Maximum Duty Cycle	DCMAX			98		%

# MAX16936

## 36V, 220kHz to 2.2MHz Step-Down Converter with 28μA Quiescent Current

### ELECTRICAL CHARACTERISTICS (continued)

(V<sub>SUP</sub> = V<sub>SUPSW</sub> = 14V, V<sub>EN</sub> = 14V, L<sub>1</sub> = 2.2μH, C<sub>IN</sub> = 4.7μF, C<sub>OUT</sub> = 22μF, C<sub>BIAS</sub> = 1μF, C<sub>BST</sub> = 0.1μF, R<sub>FOSC</sub> = 12kΩ, T<sub>A</sub> = T<sub>J</sub> = -40°C to +125°C, unless otherwise noted. Typical values are at T<sub>A</sub> = +25°C.)

PARAMETER	SYMBOL	CONDITIONS	MIN	TYP	MAX	UNITS
<b>OSCILLATOR FREQUENCY</b>						
Oscillator Frequency		R <sub>FOSC</sub> = 73.2kΩ	340	400	460	kHz
		R <sub>FOSC</sub> = 12kΩ	2.0	2.2	2.4	MHz
<b>EXTERNAL CLOCK INPUT (FSYNC)</b>						
External Input Clock Acquisition time	t <sub>FSYNC</sub>			1		Cycles
External Input Clock Frequency		R <sub>FOSC</sub> = 12kΩ (Note 5)	1.8		2.6	MHz
External Input Clock High Threshold	V <sub>FSYNC_HI</sub>	V <sub>FSYNC</sub> rising	1.4			V
External Input Clock Low Threshold	V <sub>FSYNC_LO</sub>	V <sub>FSYNC</sub> falling			0.4	V
Soft-Start Time	t <sub>SS</sub>		5.6	8	12	ms
<b>ENABLE INPUT (EN)</b>						
Enable Input High Threshold	V <sub>EN_HI</sub>		2.4			V
Enable Input Low Threshold	V <sub>EN_LO</sub>				0.6	
Enable Threshold Voltage Hysteresis	V <sub>EN_HYS</sub>			0.2		V
Enable Input Current	I <sub>EN</sub>	T <sub>A</sub> = +25°C		0.1	1	μA
<b>POWER GOOD (PGOOD)</b>						
PGOOD Switching Level	V <sub>TH_RISING</sub>	V <sub>FB</sub> rising, V <sub>PGOOD</sub> = high	93	95	97	%V <sub>FB</sub>
	V <sub>TH_FALLING</sub>	V <sub>FB</sub> falling, V <sub>PGOOD</sub> = low	90	92	94	
PGOOD Debounce Time			10	25	50	μs
PGOOD Output Low Voltage		I <sub>SINK</sub> = 5mA			0.4	V
PGOOD Leakage Current		V <sub>OUT</sub> in regulation, T <sub>A</sub> = +25°C			1	μA
SYNCOUT Low Voltage		I <sub>SINK</sub> = 5mA			0.4	V
SYNCOUT Leakage Current		T <sub>A</sub> = +25°C			1	μA
FSYNC Leakage Current		T <sub>A</sub> = +25°C			1	μA
<b>OVERVOLTAGE PROTECTION</b>						
Overvoltage Protection Threshold		V <sub>OUT</sub> rising (monitored at FB pin)		107		%
		V <sub>OUT</sub> falling (monitored at FB pin)		105		

**Note 2:** Device not in dropout condition.

**Note 3:** Guaranteed by design; not production tested.

**Note 4:** FB regulation voltage is 1%, 1.01V (max), for -40°C < T<sub>A</sub> < +105°C.

**Note 5:** Contact the factory for SYNC frequency outside the specified range.

# MAX16936

## 36V, 220kHz to 2.2MHz Step-Down Converter with 28 $\mu$ A Quiescent Current

### Typical Operating Characteristics

( $V_{SUP} = V_{SUPSW} = 14V$ ,  $V_{EN} = 14V$ ,  $V_{OUT} = 5V$ ,  $V_{FYSNC} = 0V$ ,  $R_{FOSC} = 12k\Omega$ ,  $T_A = +25^\circ C$ , unless otherwise noted.)

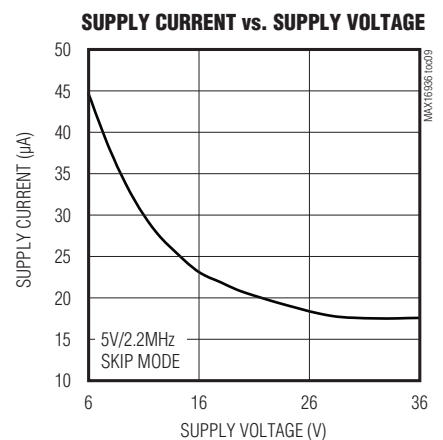
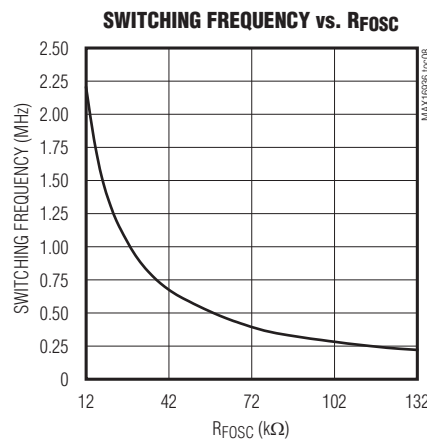
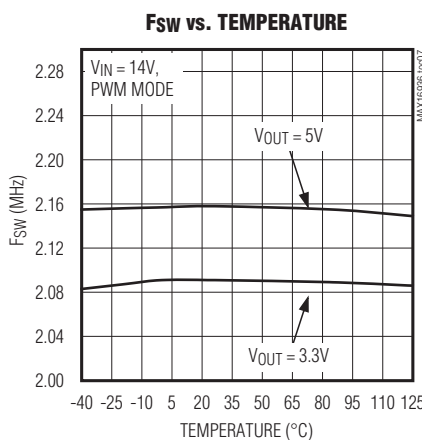
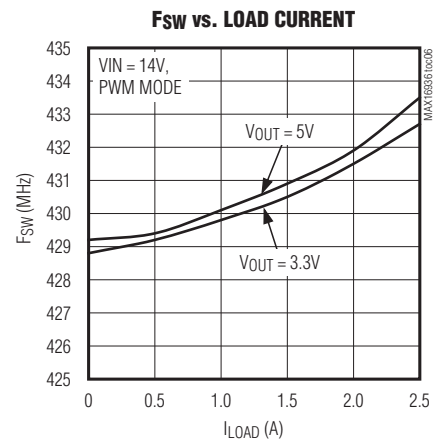
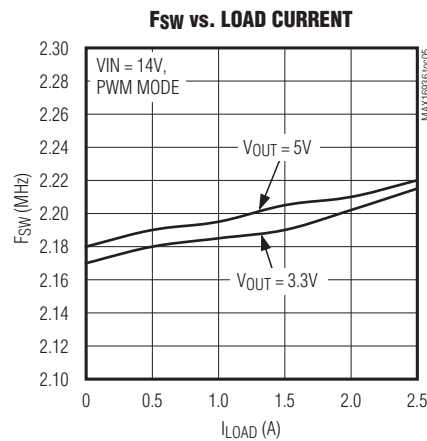
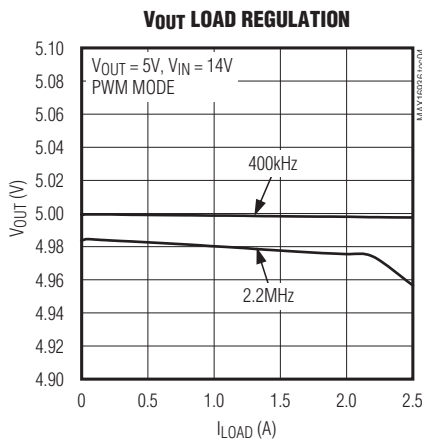
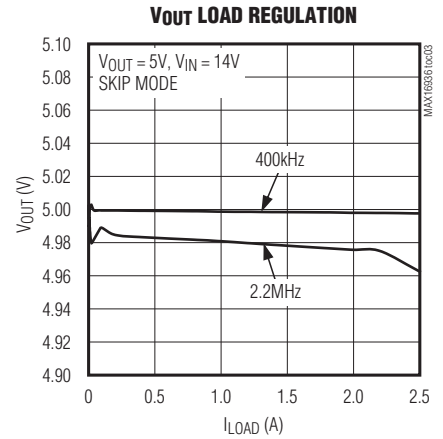
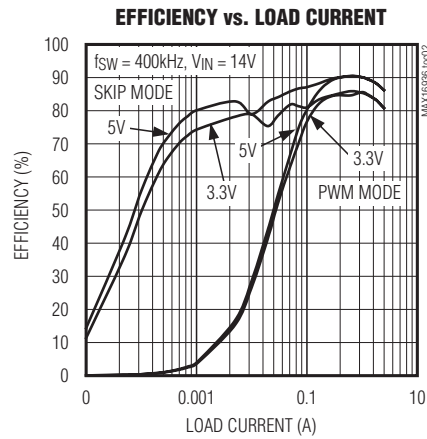
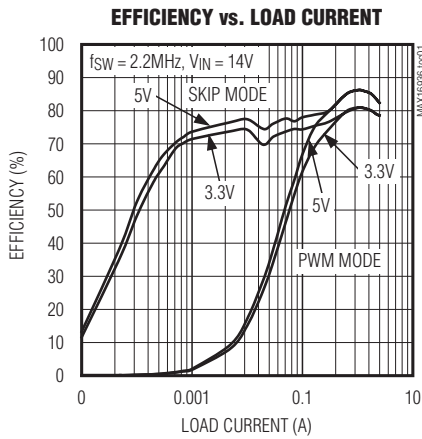

# MAX16936

## 36V, 220kHz to 2.2MHz Step-Down Converter with 28 $\mu$ A Quiescent Current

### Typical Operating Characteristics (continued)

( $V_{SUP} = V_{SUPSW} = 14V$ ,  $V_{EN} = 14V$ ,  $V_{OUT} = 5V$ ,  $V_{FYSNC} = 0V$ ,  $R_{FOSC} = 12k\Omega$ ,  $T_A = +25^\circ C$ , unless otherwise noted.)

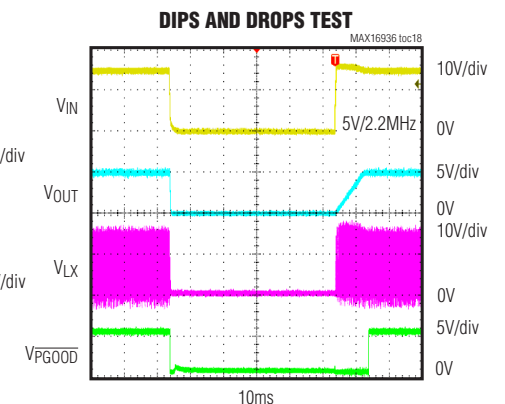
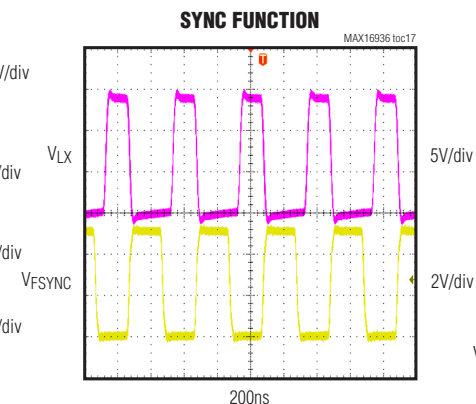
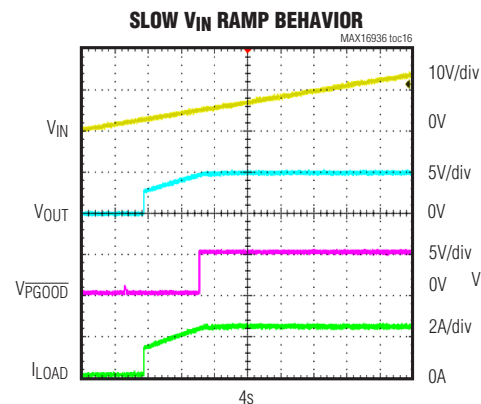
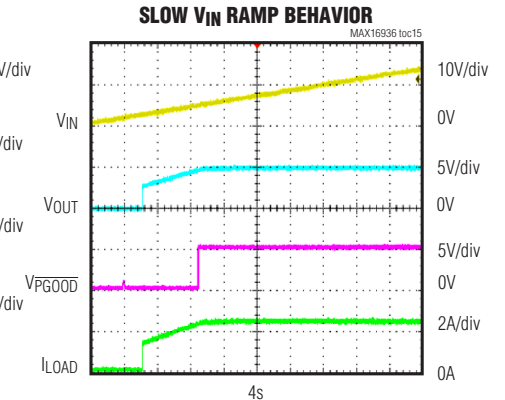
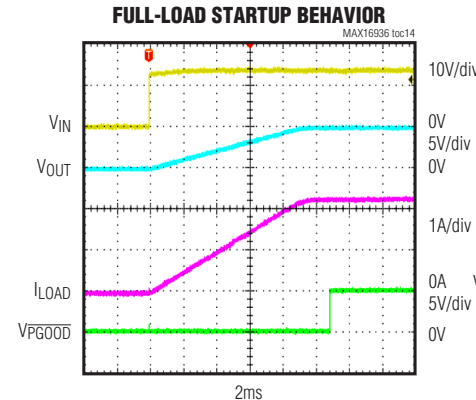
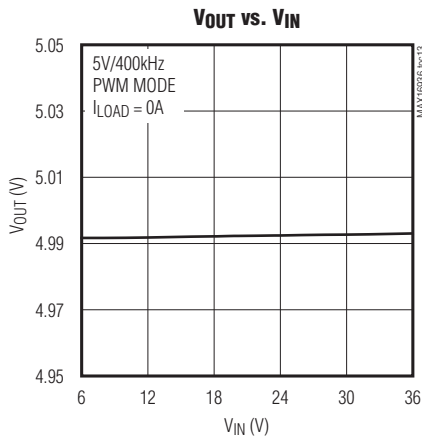
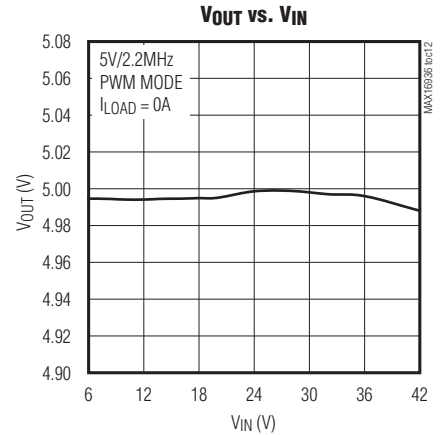
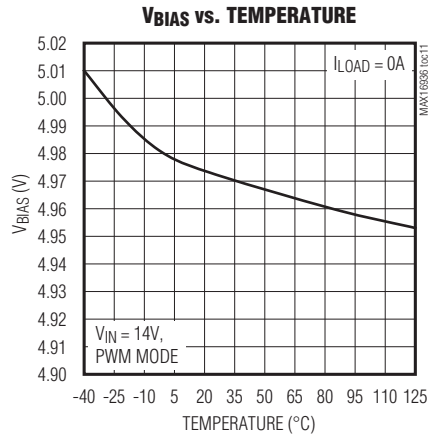
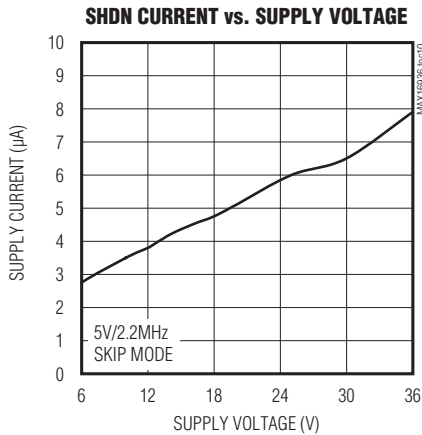

# MAX16936

## 36V, 220kHz to 2.2MHz Step-Down Converter with 28 $\mu$ A Quiescent Current

### Typical Operating Characteristics (continued)

( $V_{SUP} = V_{SUPSW} = 14V$ ,  $V_{EN} = 14V$ ,  $V_{OUT} = 5V$ ,  $V_{FYSNC} = 0V$ ,  $R_{FOOSC} = 12k\Omega$ ,  $T_A = +25^\circ C$ , unless otherwise noted.)

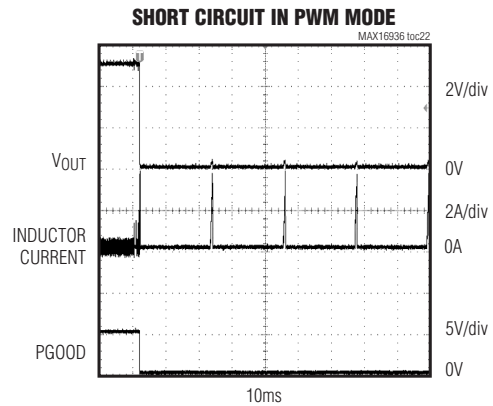
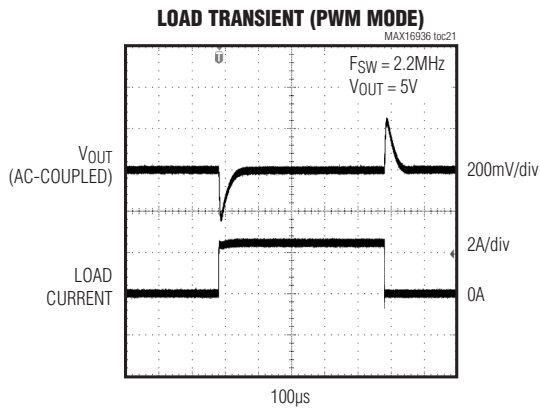
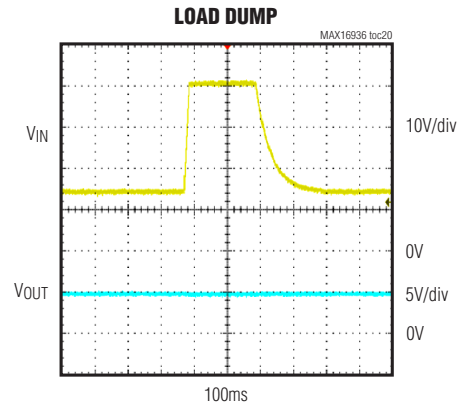
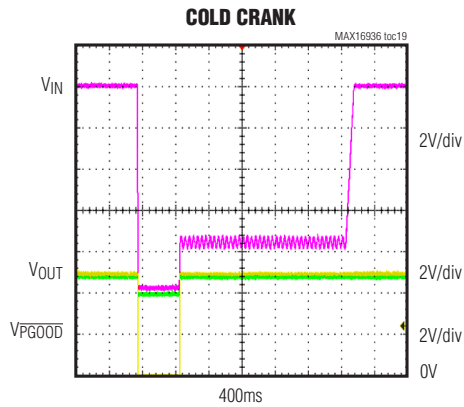

# MAX16936

## 36V, 220kHz to 2.2MHz Step-Down Converter with 28µA Quiescent Current

### Pin Configurations

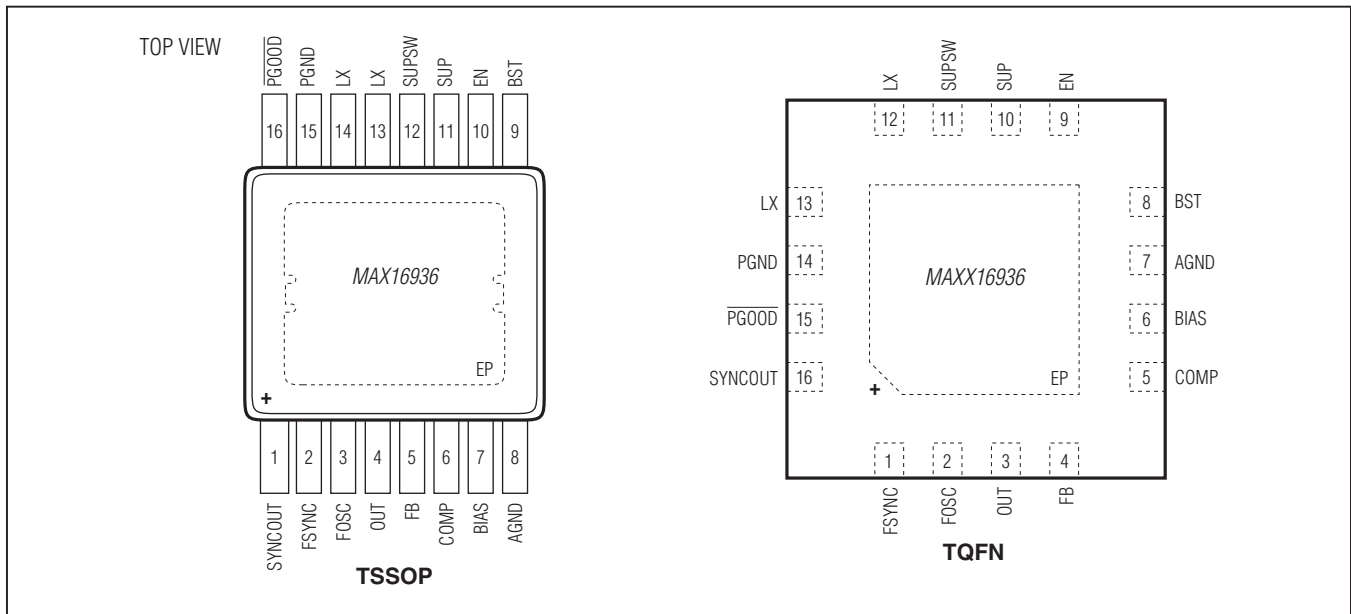

### Pin Descriptions

PIN		NAME	FUNCTION
TSSOP	TQFN		
1	16	SYNCOUT	Open-Drain Clock Output. SYNCOUT outputs 180° out-of-phase signal relative to the internal oscillator. Connect to OUT with a resistor between 100Ω and 1kΩ for 2MHz operation. For low frequency operation, use a resistor between 1kΩ and 10kΩ.
2	1	FSYNC	Synchronization Input. The device synchronizes to an external signal applied to FSYNC. Connect FSYNC to AGND to enable skip mode operation. Connect to BIAS or to an external clock to enable fixed-frequency forced PWM mode operation.
3	2	FOSC	Resistor-Programmable Switching Frequency Setting Control Input. Connect a resistor from FOSC to AGND to set the switching frequency.
4	3	OUT	Switching Regulator Output. OUT also provides power to the internal circuitry when the output voltage of the converter is set between 3V to 5V during standby mode.
5	4	FB	Feedback Input. Connect an external resistive divider from OUT to FB and AGND to set the output voltage. Connect to BIAS to set the output voltage to 5V.
6	5	COMP	Error Amplifier Output. Connect an RC network from COMP to AGND for stable operation. See the <i>Compensation Network</i> section for more information.
7	6	BIAS	Linear Regulator Output. BIAS powers up the internal circuitry. Bypass with a 1µF capacitor to ground.
8	7	AGND	Analog Ground
9	8	BST	High-Side Driver Supply. Connect a 0.1µF capacitor between LX and BST for proper operation.



# MAX16936

## 36V, 220kHz to 2.2MHz Step-Down Converter with 28µA Quiescent Current

### Pin Descriptions (continued)

PIN		NAME	FUNCTION
TSSOP	TQFN		
10	9	EN	SUP Voltage Compatible Enable Input. Drive EN low to disable the device. Drive EN high to enable the device.
11	10	SUP	Voltage Supply Input. SUP powers up the internal linear regulator. Bypass SUP to PGND with a 4.7µF ceramic capacitor.
12	11	SUPSW	Internal High-Side Switch Supply Input. SUPSW provides power to the internal switch. Bypass SUPSW to PGND with 0.1µF and 4.7µF ceramic capacitors.
13, 14	12, 13	LX	Inductor Switching Node. Connect a Schottky diode between LX and AGND.
15	14	PGND	Power Ground
16	15	$\overline{\text{PGOOD}}$	Open-Drain, Active-Low Power-Good Output. $\overline{\text{PGOOD}}$ asserts when VOUT is above 95% regulation point. $\overline{\text{PGOOD}}$ goes low when VOUT is below 92% regulation point.
—	—	EP	Exposed Pad. Connect EP to a large-area contiguous copper ground plane for effective power dissipation. Do not use as the only IC ground connection. EP must be connected to PGND.

### Detailed Description

The MAX16936 is a 2.5A current-mode step-down converter with integrated high-side and low-side MOSFETs designed to operate with an external Schottky diode for better efficiency. The low-side MOSFET enables fixed-frequency forced-PWM (FPWM) operation under light-load applications. The device operates with input voltages from 3.5V to 36V, while using only 28µA quiescent current at no load. The switching frequency is resistor programmable from 220kHz to 2.2MHz and can be synchronized to an external clock. The output voltage is available as 5V/3.3V fixed or adjustable from 1V to 10V. The wide input voltage range along with its ability to operate at 98% duty cycle during undervoltage transients make the device ideal for automotive and industrial applications.

Under light-load applications, the FSYNC logic input allows the device to either operate in skip mode for reduced current consumption or fixed-frequency FPWM mode to eliminate frequency variation to minimize EMI. Fixed frequency FPWM mode is extremely useful for power supplies designed for RF transceivers where tight emission control is necessary. Protection features include cycle-by-cycle current limit, overvoltage protection, and thermal shutdown with automatic recovery. Additional features include a power-good monitor to ease power-supply

sequencing and a 180° out-of-phase clock output relative to the internal oscillator at SYNCOUT to create cascaded power supplies with multiple devices.

### Wide Input Voltage Range

The device includes two separate supply inputs (SUP and SUPSW) specified for a wide 3.5V to 36V input voltage range.  $V_{\text{SUP}}$  provides power to the device and  $V_{\text{SUPSW}}$  provides power to the internal switch. When the device is operating with a 3.5V input supply, conditions such as cold crank can cause the voltage at SUP and SUPSW to drop below the programmed output voltage. Under such conditions, the device operates in a high duty-cycle mode to facilitate minimum dropout from input to output.

### Linear Regulator Output (BIAS)

The device includes a 5V linear regulator (BIAS) that provides power to the internal circuit blocks. Connect a 1µF ceramic capacitor from BIAS to AGND. When the output voltage is set between 3V and 5.5V, the internal linear regulator only provides power until the output is in regulation. The internal linear regulator turns off once the output is in regulation and allows OUT to provide power to the device. The internal regulator turns back on once the external load on the output of the device is higher than 100mA. In addition, the linear regulator turns on anytime the output voltage is outside the 3V to 5.5V range.

# MAX16936

## 36V, 220kHz to 2.2MHz Step-Down Converter with 28µA Quiescent Current

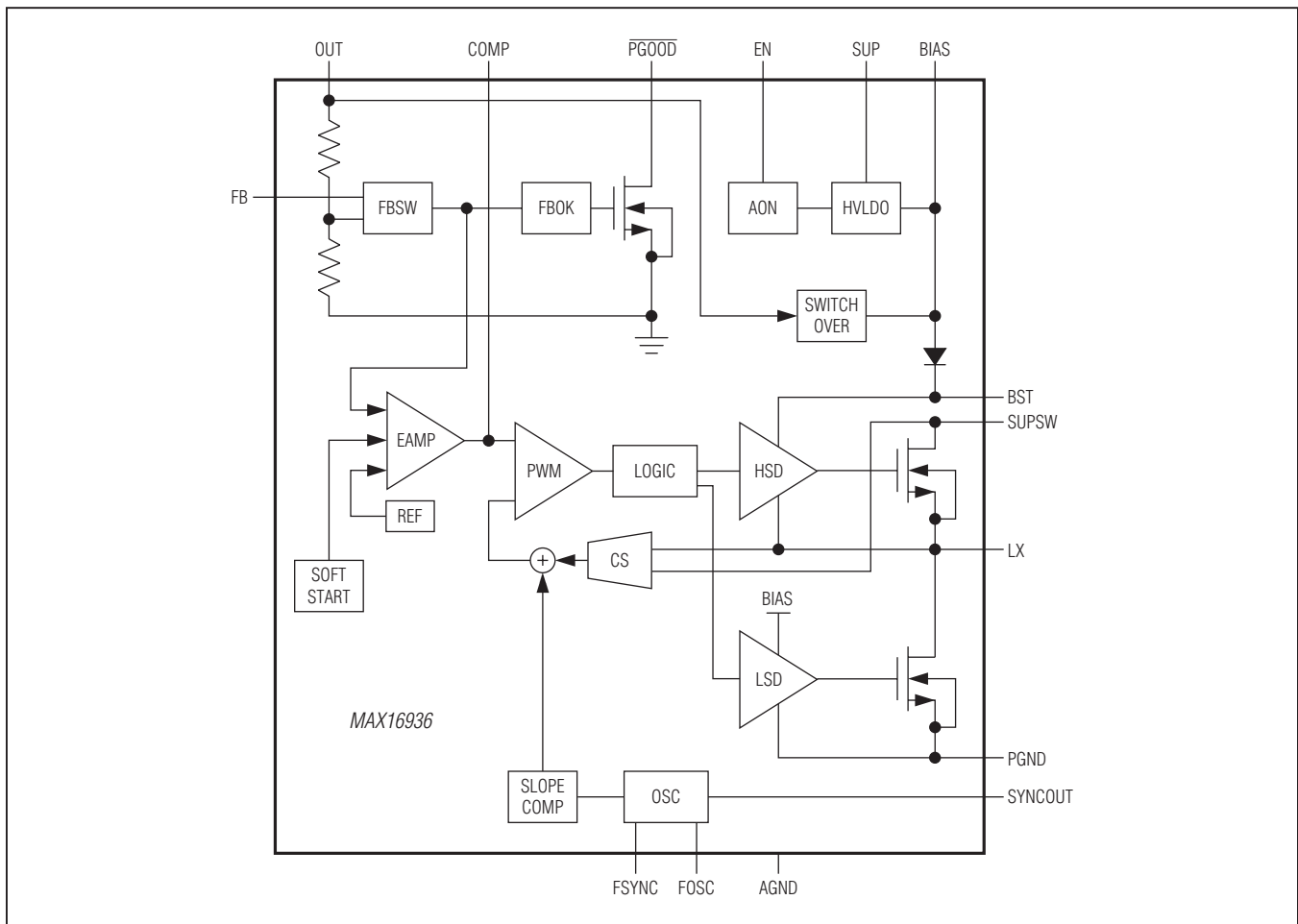

Figure 1. Internal Block Diagram

### Power-Good Output (PGOOD)

The device features an open-drain power-good output,  $\overline{\text{PGOOD}}$ .  $\overline{\text{PGOOD}}$  asserts when  $V_{\text{OUT}}$  rises above 95% of its regulation voltage.  $\overline{\text{PGOOD}}$  deasserts when  $V_{\text{OUT}}$  drops below 92% of its regulation voltage. Connect  $\overline{\text{PGOOD}}$  to BIAS with a 10kΩ resistor.

### Synchronization Input (FSYNC)

FSYNC is a logic-level input useful for operating mode selection and frequency control. Connecting FSYNC to BIAS or to an external clock enables fixed-frequency FPWM operation. Connecting FSYNC to AGND enables skip mode operation.

The external clock frequency at FSYNC can be higher or lower than the internal clock by 20%. Ensure the duty cycle of the external clock used has a minimum pulse

width of 100ns. The device synchronizes to the external clock within one cycle. When the external clock signal at FSYNC is absent for more than two clock cycles, the device reverts back to the internal clock.

### System Enable (EN)

An enable control input (EN) activates the device from its low-power shutdown mode. EN is compatible with inputs from automotive battery level down to 3.5V. The high voltage compatibility allows EN to be connected to SUP, KEY/KL30, or the inhibit pin (INH) of a CAN transceiver.

EN turns on the internal regulator. Once  $V_{\text{BIAS}}$  is above the internal lockout threshold,  $V_{\text{UVL}} = 3.15\text{V}$  (typ), the controller activates and the output voltage ramps up within 8ms.

# MAX16936

## 36V, 220kHz to 2.2MHz Step-Down Converter with 28μA Quiescent Current

A logic-low at EN shuts down the device. During shutdown, the internal linear regulator and gate drivers turn off. Shutdown is the lowest power state and reduces the quiescent current to 5μA (typ). Drive EN high to bring the device out of shutdown.

### Spread-Spectrum Option

The MAX16936 has an internal spread-spectrum option to optimize EMI performance. This is factory set and the S-version of the IC should be ordered. For spread-spectrum-enabled ICs, the operating frequency is varied  $\pm 6\%$  centered on FOSC. The modulation signal is a triangular wave with a period of 110μs at 2.2MHz. Therefore, FOSC will ramp down 6% and back to 2.2MHz in 110μs and also ramp up 6% and back to 2.2MHz in 110μs. The cycle repeats.

For operations at FOSC values other than 2.2MHz, the modulation signal scales proportionally, e.g., at 400kHz, the 110μs modulation period increases to  $110\mu\text{s} \times 2.2\text{MHz}/400\text{kHz} = 605\mu\text{s}$ .

The internal spread spectrum is disabled if the IC is synced to an external clock. However, the IC does not filter the input clock and passes any modulation (including spread-spectrum) present on the driving external clock to the SYNCOUT pin.

### Automatic Slew-Rate Control on LX

The MAX16936 has automatic slew-rate adjustment that optimizes the rise times on the internal HSFET gate drive to minimize EMI. The IC detects the internal clock frequency and adjusts the slew rate accordingly. When the user selects the external frequency setting resistor R<sub>FOSC</sub> such that the frequency is > 1.1MHz, the HSFET is turned on in 4ns (typ). When the frequency is < 1.1MHz the HSFET is turned on in 8ns (typ). This slew-rate control optimizes the rise time on LX node externally to minimize EMI while maintaining good efficiency.

### Internal Oscillator (FOSC)

The switching frequency, f<sub>SW</sub>, is set by a resistor (R<sub>FOSC</sub>) connected from FOSC to AGND. See Figure 3 to select the correct R<sub>FOSC</sub> value for the desired switching frequency. For example, a 400kHz switching frequency is set with R<sub>FOSC</sub> = 73.2kΩ. Higher frequencies allow designs with lower inductor values and less output capacitance. Consequently, peak currents and I<sup>2</sup>R losses are lower at higher switching frequencies, but core losses, gate charge currents, and switching losses increase.

### Synchronizing Output (SYNCOUT)

SYNCOUT is an open-drain output that outputs a 180° out-of-phase signal relative to the internal oscillator.

### Overtemperature Protection

Thermal-overload protection limits the total power dissipation in the device. When the junction temperature exceeds 175°C (typ), an internal thermal sensor shuts down the internal bias regulator and the step-down controller, allowing the device to cool. The thermal sensor turns on the device again after the junction temperature cools by 15°C.

## Applications Information

### Setting the Output Voltage

Connect FB to BIAS for a fixed +5V/+3.3 output voltage. To set the output to other voltages between 1V and 10V, connect a resistive divider from output (OUT) to FB to AGND (Figure 2). Use the following formula to determine the R<sub>FB2</sub> of the resistive divider network:

$$R_{FB2} = R_{TOTAL} \times V_{FB}/V_{OUT}$$

where V<sub>FB</sub> = 1V, R<sub>TOTAL</sub> = selected total resistance of R<sub>FB1</sub>, R<sub>FB2</sub> in Ω, and V<sub>OUT</sub> is the desired output in volts.

Calculate R<sub>FB1</sub> (OUT to FB resistor) with the following equation:

$$R_{FB1} = R_{FB2} \left[ \left( \frac{V_{OUT}}{V_{FB}} \right) - 1 \right]$$

where V<sub>FB</sub> = 1V (see the [Electrical Characteristics](#) table).

### FPWM/Skip Modes

The MAX16936 offers a pin selectable skip mode or fixed-frequency PWM mode option. The IC has an internal LS MOSFET that turns on when the FSYNC pin is connected to V<sub>BIAS</sub> or if there is a clock present on the FSYNC pin. This enables the fixed-frequency-forced PWM mode operation over the entire load range. This option allows the user to maintain fixed frequency over the entire load range in applications that require tight control on EMI. Even though the MAX16936 has an internal LS MOSFET for fixed-frequency operation, an external Schottky diode is still required to sup-

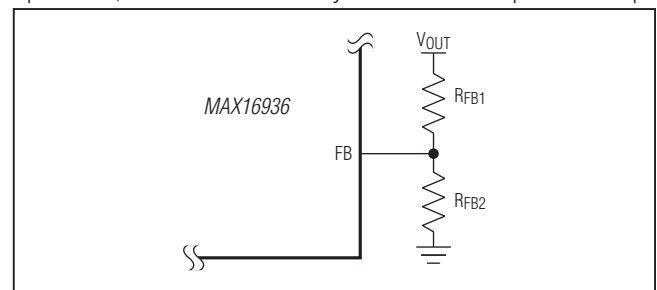

Figure 2. Adjustable Output Voltage Setting

# MAX16936

## 36V, 220kHz to 2.2MHz Step-Down Converter with 28µA Quiescent Current

port the entire load range. If the FSYNC pin is connected to GND, the skip mode is enabled on the MAX16936.

In skip mode of operation, the converter's switching frequency is load dependent. At higher load current, the switching frequency does not change and the operating mode is similar to the FPWM mode. Skip mode helps improve efficiency in light-load applications by allowing the converters to turn on the high-side switch only when the output voltage falls below a set threshold. As such, the converters do not switch MOSFETs on and off as often as is the case in the FPWM mode. Consequently, the gate charge and switching losses are much lower in skip mode.

### Inductor Selection

Three key inductor parameters must be specified for operation with the device: inductance value (L), inductor saturation current (I<sub>SAT</sub>), and DC resistance (R<sub>DCR</sub>). To select inductance value, the ratio of inductor peak-to-peak AC current to DC average current (LIR) must be selected first. A good compromise between size and loss is a 30% peak-to-peak ripple current to average current ratio (LIR = 0.3). The switching frequency, input voltage, output voltage, and selected LIR then determine the inductor value as follows:

$$L = \frac{V_{OUT} (V_{SUP} - V_{OUT})}{V_{SUP} f_{SW} I_{OUT} LIR}$$

where V<sub>SUP</sub>, V<sub>OUT</sub>, and I<sub>OUT</sub> are typical values (so that efficiency is optimum for typical conditions). The switching

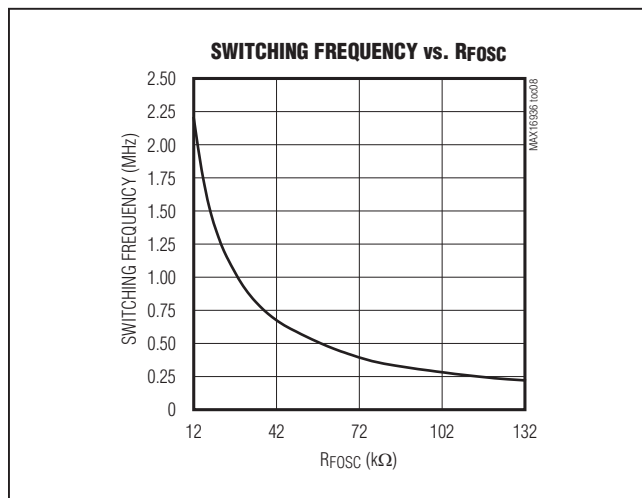

Figure 3. Switching Frequency vs. Rfosc (see Figure 3).

### Input Capacitor

The input filter capacitor reduces peak currents drawn from the power source and reduces noise and voltage ripple on the input caused by the circuit's switching.

The input capacitor RMS current requirement (I<sub>RMS</sub>) is defined by the following equation:

$$I_{RMS} = I_{LOAD(MAX)} \frac{\sqrt{V_{OUT} (V_{SUP} - V_{OUT})}}{V_{SUP}}$$

I<sub>RMS</sub> has a maximum value when the input voltage equals twice the output voltage (V<sub>SUP</sub> = 2V<sub>OUT</sub>), so I<sub>RMS(MAX)</sub> = I<sub>LOAD(MAX)</sub>/2.

Choose an input capacitor that exhibits less than +10°C self-heating temperature rise at the RMS input current for optimal long-term reliability.

The input voltage ripple is composed of ΔV<sub>Q</sub> (caused by the capacitor discharge) and ΔV<sub>ESR</sub> (caused by the ESR of the capacitor). Use low-ESR ceramic capacitors with high ripple current capability at the input. Assume the contribution from the ESR and capacitor discharge equal to 50%. Calculate the input capacitance and ESR required for a specified input voltage ripple using the following equations:

$$ESR_{IN} = \frac{\Delta V_{ESR}}{I_{OUT} + \frac{\Delta I_L}{2}}$$

where:

$$\Delta I_L = \frac{(V_{SUP} - V_{OUT}) \times V_{OUT}}{V_{SUP} \times f_{SW} \times L}$$

and:

$$C_{IN} = \frac{I_{OUT} \times D(1-D)}{\Delta V_Q \times f_{SW}} \text{ and } D = \frac{V_{OUT}}{V_{SUP}}$$

where I<sub>OUT</sub> is the maximum output current and D is the duty cycle.

### Output Capacitor

The output filter capacitor must have low enough ESR to meet output ripple and load transient requirements. The output capacitance must be high enough to absorb the inductor energy while transitioning from full-load to no-load conditions without tripping the overvoltage fault protection. When using high-capacitance, low-ESR capacitors, the filter capacitor's ESR dominates the output

## 36V, 220kHz to 2.2MHz Step-Down Converter with 28µA Quiescent Current

voltage ripple. So the size of the output capacitor depends on the maximum ESR required to meet the output voltage ripple ( $V_{RIPPLE(P-P)}$ ) specifications:

$$V_{RIPPLE(P-P)} = ESR \times I_{LOAD(MAX)} \times LIR$$

The actual capacitance value required relates to the physical size needed to achieve low ESR, as well as to the chemistry of the capacitor technology. Thus, the capacitor is usually selected by ESR and voltage rating rather than by capacitance value.

When using low-capacity filter capacitors, such as ceramic capacitors, size is usually determined by the capacity needed to prevent voltage droop and voltage rise from causing problems during load transients. Generally, once enough capacitance is added to meet the overshoot requirement, undershoot at the rising load edge is no longer a problem. However, low capacity filter capacitors typically have high ESR zeros that can affect the overall stability.

### Rectifier Selection

The device requires an external Schottky diode rectifier as a freewheeling diode when the device is configured for skip mode operation. Connect this rectifier close to the device using short leads and short PCB traces. In FPWM mode, the Schottky diode helps minimize efficiency losses by diverting the inductor current that would otherwise flow through the low-side MOSFET. Choose a rectifier with a voltage rating greater than the maximum expected input voltage,  $V_{SUPSW}$ . Use a low forward-voltage-drop Schottky rectifier to limit the negative voltage at LX. Avoid higher than necessary reverse-voltage Schottky rectifiers that have higher forward-voltage drops.

### Compensation Network

The device uses an internal transconductance error amplifier with its inverting input and its output available to the user for external frequency compensation. The output capacitor and compensation network determine the loop stability. The inductor and the output capacitor are chosen based on performance, size, and cost. Additionally, the compensation network optimizes the control-loop stability.

The controller uses a current-mode control scheme that regulates the output voltage by forcing the required current through the external inductor. The device uses the voltage drop across the high-side MOSFET to sense inductor current. Current-mode control eliminates the double pole in the feedback loop caused by the inductor and output capacitor, resulting in a smaller phase shift

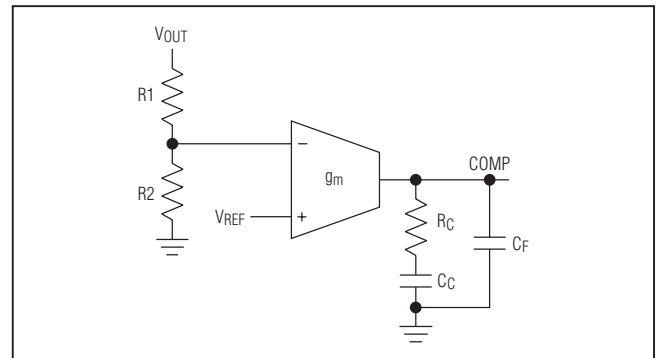

Figure 4. Compensation Network

and requiring less elaborate error-amplifier compensation than voltage-mode control. Only a simple single-series resistor ( $R_C$ ) and capacitor ( $C_C$ ) are required to have a stable, high-bandwidth loop in applications where ceramic capacitors are used for output filtering (Figure 4). For other types of capacitors, due to the higher capacitance and ESR, the frequency of the zero created by the capacitance and ESR is lower than the desired closed-loop crossover frequency. To stabilize a nonceramic output capacitor loop, add another compensation capacitor ( $C_F$ ) from COMP to GND to cancel this ESR zero.

The basic regulator loop is modeled as a power modulator, output feedback divider, and an error amplifier. The power modulator has a DC gain set by  $g_m \times R_{LOAD}$ , with a pole and zero pair set by  $R_{LOAD}$ , the output capacitor ( $C_{OUT}$ ), and its ESR. The following equations allow to approximate the value for the gain of the power modulator ( $GAIN_{MOD(dc)}$ ), neglecting the effect of the ramp stabilization. Ramp stabilization is necessary when the duty cycle is above 50% and is internally done for the device.

$$GAIN_{MOD(dc)} = g_m \times R_{LOAD}$$

where  $R_{LOAD} = V_{OUT}/I_{LOAD(MAX)}$  in  $\Omega$  and  $g_m = 3S$ .

In a current-mode step-down converter, the output capacitor, its ESR, and the load resistance introduce a pole at the following frequency:

$$f_{pMOD} = 1/(2\pi \times C_{OUT} \times R_{LOAD})$$

The output capacitor and its ESR also introduce a zero at:

$$f_{zMOD} = \frac{1}{2\pi \times ESR \times C_{OUT}}$$



## 36V, 220kHz to 2.2MHz Step-Down Converter with 28µA Quiescent Current

When  $C_{OUT}$  is composed of “n” identical capacitors in parallel, the resulting  $C_{OUT} = n \times C_{OUT(EACH)}$ , and  $ESR = ESR_{(EACH)}/n$ . Note that the capacitor zero for a parallel combination of alike capacitors is the same as for an individual capacitor.

The feedback voltage-divider has a gain of  $GAIN_{FB} = V_{FB}/V_{OUT}$ , where  $V_{FB}$  is 1V (typ). The transconductance error amplifier has a DC gain of  $GAIN_{EA(dc)} = g_{m,EA} \times R_{OUT,EA}$ , where  $g_{m,EA}$  is the error amplifier transconductance, which is 700µS (typ), and  $R_{OUT,EA}$  is the output resistance of the error amplifier 50MΩ.

A dominant pole ( $f_{dpEA}$ ) is set by the compensation capacitor ( $C_C$ ) and the amplifier output resistance ( $R_{OUT,EA}$ ). A zero ( $f_{zEA}$ ) is set by the compensation resistor ( $R_C$ ) and the compensation capacitor ( $C_C$ ). There is an optional pole ( $f_{pEA}$ ) set by  $C_F$  and  $R_C$  to cancel the output capacitor ESR zero if it occurs near the cross over frequency ( $f_C$ , where the loop gain equals 1 (0dB)). Thus:

$$f_{dpEA} = \frac{1}{2\pi \times C_C \times (R_{OUT,EA} + R_C)}$$

$$f_{zEA} = \frac{1}{2\pi \times C_C \times R_C}$$

$$f_{pEA} = \frac{1}{2\pi \times C_F \times R_C}$$

The loop-gain crossover frequency ( $f_C$ ) should be set below 1/5th of the switching frequency and much higher than the power-modulator pole ( $f_{pMOD}$ ):

$$f_{pMOD} \ll f_C \leq \frac{f_{SW}}{5}$$

The total loop gain as the product of the modulator gain, the feedback voltage-divider gain, and the error amplifier gain at  $f_C$  should be equal to 1. So:

$$GAIN_{MOD}(f_C) \times \frac{V_{FB}}{V_{OUT}} \times GAIN_{EA}(f_C) = 1$$

$$GAIN_{EA}(f_C) = g_{m,EA} \times R_C$$

$$GAIN_{MOD}(f_C) = GAIN_{MOD}(dc) \times \frac{f_{pMOD}}{f_C}$$

Therefore:

$$GAIN_{MOD}(f_C) \times \frac{V_{FB}}{V_{OUT}} \times g_{m,EA} \times R_C = 1$$

Solving for  $R_C$ :

$$R_C = \frac{V_{OUT}}{g_{m,EA} \times V_{FB} \times GAIN_{MOD}(f_C)}$$

Set the error-amplifier compensation zero formed by  $R_C$  and  $C_C$  ( $f_{zEA}$ ) at the  $f_{pMOD}$ . Calculate the value of  $C_C$  as follows:

$$C_C = \frac{1}{2\pi \times f_{pMOD} \times R_C}$$

If  $f_{zMOD}$  is less than  $5 \times f_C$ , add a second capacitor,  $C_F$ , from COMP to GND and set the compensation pole formed by  $R_C$  and  $C_F$  ( $f_{pEA}$ ) at the  $f_{zMOD}$ . Calculate the value of  $C_F$  as follows:

$$C_F = \frac{1}{2\pi \times f_{zMOD} \times R_C}$$

As the load current decreases, the modulator pole also decreases; however, the modulator gain increases accordingly and the crossover frequency remains the same.

### PCB Layout Guidelines

Careful PCB layout is critical to achieve low switching losses and clean, stable operation. Use a multilayer board whenever possible for better noise immunity and power dissipation. Follow these guidelines for good PCB layout:

- 1) Use a large contiguous copper plane under the IC package. Ensure that all heat-dissipating components have adequate cooling. The bottom pad of the IC must be soldered down to this copper plane for effective heat dissipation and for getting the full power out of the IC. Use multiple vias or a single large via in this plane for heat dissipation.
- 2) Isolate the power components and high current path from the sensitive analog circuitry. Doing so is essential to prevent any noise coupling into the analog signals.
- 3) Keep the high-current paths short, especially at the ground terminals. This practice is essential for stable, jitter-free operation. The high-current path composed of the input capacitor, high-side FET, inductor, and the output capacitor should be as short as possible.
- 4) Keep the power traces and load connections short. This practice is essential for high efficiency. Use thick copper PCBs (2oz vs. 1oz) to enhance full-load efficiency.
- 5) The analog signal lines should be routed away from the high-frequency planes. Doing so ensures integrity of sensitive signals feeding back into the IC.

# MAX16936

## 36V, 220kHz to 2.2MHz Step-Down Converter with 28µA Quiescent Current

6) The ground connection for the analog and power section should be close to the IC. This keeps the ground current loops to a minimum. In cases where only one

ground is used, enough isolation between analog return signals and high power signals must be maintained.

### Typical Application Circuit

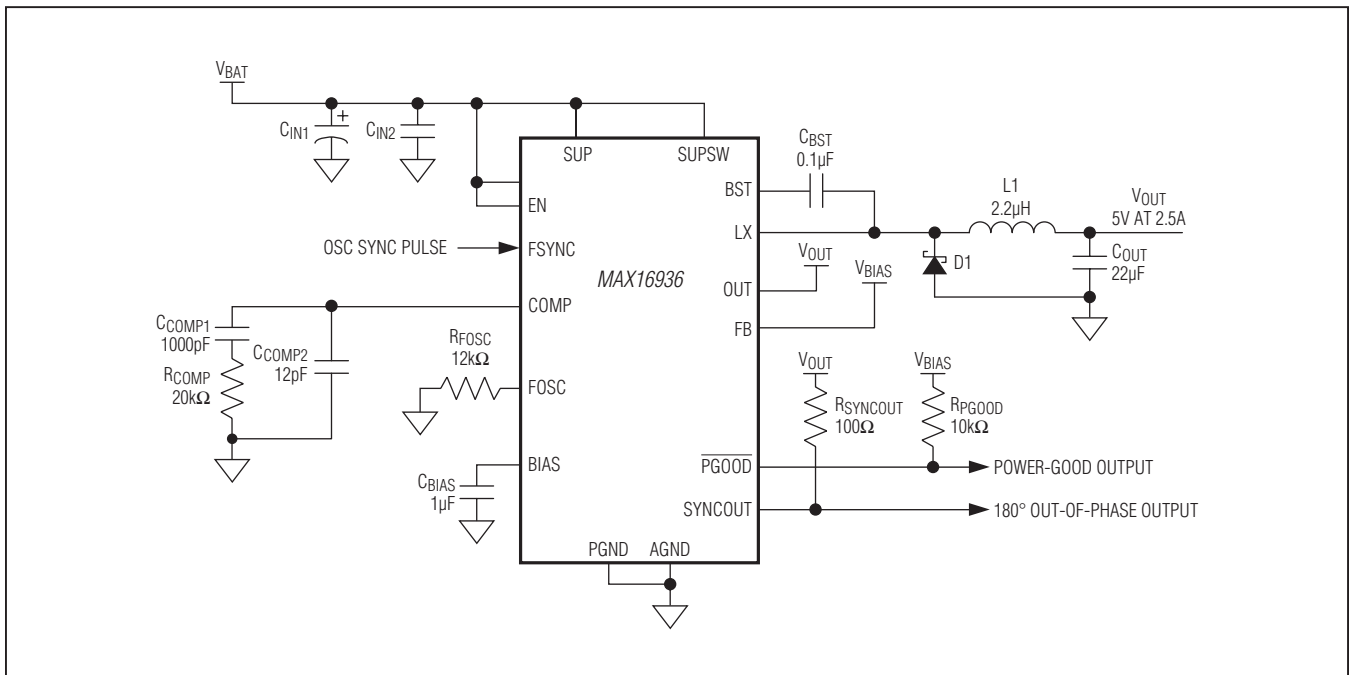

# MAX16936

## 36V, 220kHz to 2.2MHz Step-Down Converter with 28µA Quiescent Current

### Ordering Information/Selector Guide

PART	V <sub>OUT</sub>		SPREAD SPECTRUM	TEMP RANGE	PIN-PACKAGE
	ADJUSTABLE (FB CONNECTED TO RESISTIVE DIVIDER) (V)	FIXED (FB CONNECTED TO BIAS) (V)			
MAX16936RAUEA/V+	1 to 10	5	Off	-40°C to +125°C	16 TSSOP-EP**
MAX16936RAUEB/V+	1 to 10	3.3	Off	-40°C to +125°C	16 TSSOP-EP**
MAX16936SAUEA/V+	1 to 10	5	On	-40°C to +125°C	16 TSSOP-EP**
MAX16936SAUEB/V+	1 to 10	3.3	On	-40°C to +125°C	16 TSSOP-EP**
MAX16936RATEA/V+	1 to 10	5	Off	-40°C to +125°C	16 TQFN-EP**
MAX16936RATEB/V+	1 to 10	3.3	Off	-40°C to +125°C	16 TQFN-EP**
MAX16936SATEA/V+	1 to 10	5	On	-40°C to +125°C	16 TQFN-EP**
MAX16936SATEB/V+	1 to 10	3.3	On	-40°C to +125°C	16 TQFN-EP**

/V denotes an automotive qualified part.

+Denotes a lead(Pb)-free/RoHS-compliant package.

\*\*EP = Exposed pad.

### Chip Information

PROCESS: BiCMOS

### Package Information

For the latest package outline information and land patterns (footprints), go to [www.maximintegrated.com/packages](http://www.maximintegrated.com/packages). Note that a "+", "#", or "-" in the package code indicates RoHS status only. Package drawings may show a different suffix character, but the drawing pertains to the package regardless of RoHS status.

PACKAGE TYPE	PACKAGE CODE	OUTLINE NO.	LAND PATTERN NO.
16 TSSOP-EP	U16E+3	<a href="#">21-0108</a>	<a href="#">90-0120</a>
16 TQFN-EP	T1655+4	<a href="#">21-0140</a>	<a href="#">90-0121</a>



# MAX16936

## 36V, 220kHz to 2.2MHz Step-Down Converter with 28µA Quiescent Current

### Revision History

REVISION NUMBER	REVISION DATE	DESCRIPTION	PAGES CHANGED
0	3/13	Initial release	—
1	4/13	Added non-automotive OPNs to <i>Ordering Information/Selector Guide</i>	16
2	8/13	Updated FPWM and Skip Mode output voltages in <i>Electrical Characteristics, Internal Oscillator (FOSC)</i> and <i>Compensation Network</i> sections, and removed the non-automotive parts from the <i>Ordering Information/Selector Guide</i>	2, 3, 11, 13, 16
3	11/13	Removed future product references from the <i>Ordering Information/Selector Guide</i>	16
4	2/14	Changed the BST capacitor value from 0.22µF to 0.1µF in <i>Pin Descriptions</i> and <i>Typical Application Circuit</i> ; updated the <i>Linear Regulator Output (BIAS)</i> section	8, 9, 15
5	3/14	Added lead-free designation to TQFN package code	16



Maxim Integrated cannot assume responsibility for use of any circuitry other than circuitry entirely embodied in a Maxim Integrated product. No circuit patent licenses are implied. Maxim Integrated reserves the right to change the circuitry and specifications without notice at any time. The parametric values (min and max limits) shown in the Electrical Characteristics table are guaranteed. Other parametric values quoted in this data sheet are provided for guidance.

**Maxim Integrated 160 Rio Robles, San Jose, CA 95134 USA 1-408-601-1000**

17

© 2014 Maxim Integrated Products, Inc.

Maxim Integrated and the Maxim Integrated logo are trademarks of Maxim Integrated Products, Inc.

[www.BDTIC.com/maxim](http://www.BDTIC.com/maxim)