

# SOIC 14L Packing Configuration: Figure 1.0

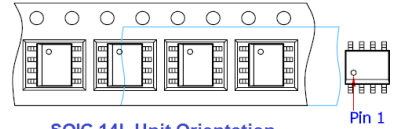
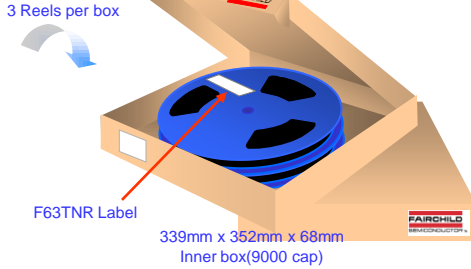
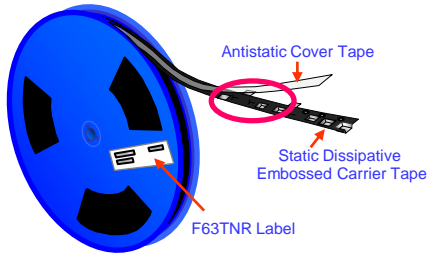

SOIC 14L Unit Orientation

## SOIC 14L Unit Orientation

### Packing Description:

SOIC 8L parts are shipped in tape. The carrier tape is made from a dissipative (carbon filled) polycarbonate resin. The cover tape is a multilayer film (Heat Activated Adhesive in nature) primarily composed of polyester film, adhesive layer, sealant, and anti-static sprayed agent. These reeled parts in standard option are shipped with 3000 units per 13" or 330cm diameter reel. The reels are dark blue or black in color and is made of polystyrene plastic (anti-static coated). This and some other options are further described in the Packing Information table.

These full reels are individually barcode labeled and placed inside a standard intermediate box (illustrated in figure 1.0) made of recyclable corrugated brown paper. One box contains three reels maximum. And these boxes are placed inside a barcode labeled shipping box which comes in different sizes depending on the number of parts shipped.

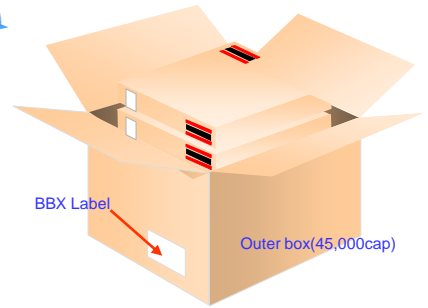
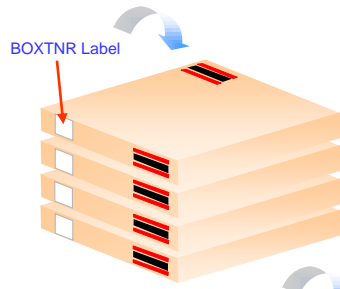

SOIC 14L Packing Information	
Packing Option	Standard
Packing type	TNR
Qty per Reel/Tube/Bag	3,000
Reel Size	13" Dia
Inner Box Dimension (mm)	339x352x68
Max qty per inner Box	9,000
Max qty per outer Box	45,000

### Reel Barcode Label Sample\_(F63TNR)

LOT: FSID: D/C1: D/C2:	AR: QTY1: QTY2:	QTY: SPEC: SPEC REV: Pb-free RoHS COMPLIANT	2nd Level interconnect: 1.Category e3 2.Maximum safe temperature 360C 3.MSL N/A FAIRCHILD SEMICONDUCTOR.
---------------------------------	-----------------------	---	--

### Inner Box Barcode Label Sample\_(BOXTNR)

LOT: FSID: D/C1: D/C2:	AR: QTY1: QTY2:	QTY: SPEC: SPEC REV: Pb-free RoHS COMPLIANT	2nd Level interconnect: 1.Category e3 2.Maximum safe temperature 360C 3.MSL N/A FAIRCHILD SEMICONDUCTOR.
---------------------------------	-----------------------	---	--

### Outer Box Barcode Label Sample\_(BBX)

PART ID: QTY:	2013/ 04 /01 07:30:00 BG-SA DC:
<b>T90831301</b>	
FAIRCHILD SEMICONDUCTOR CORPORATION.	

# SOIC 14L Tape Leader and Trailer Configuration: Figure 2.0

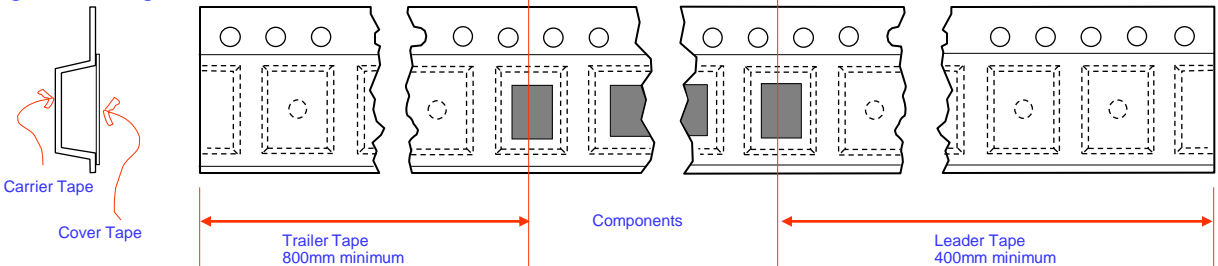

### NOTES:

- A. ALL DIMENSION ARE IN MILLIMETERS UNLESS OTHERWISE SPECIFIED
- B. DRAWING FILE NAME: PKG-M14ARev1
- C. PLASTIC REEL W1 DIMENSION CONTROL LIMITS:  
8MM REEL = +/-1.0MM AND 12MM REEL AND ABOVE = +/- 1.5MM

SOIC 14L Embossed Carrier Tape  
Configuration: Figure 3.0

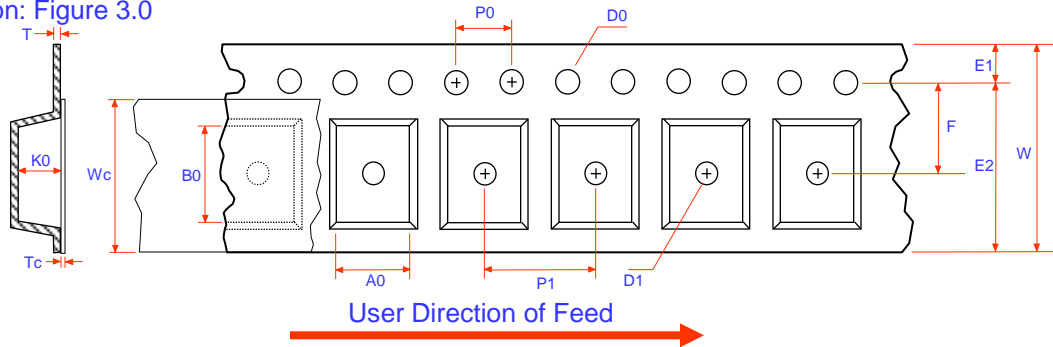

Dimensions are in millimeter

Pkg type	A0	B0	W	D0	D1	E1	E2	F	P1	P0	K0	T	Wc	Tc
SOIC 14L (16mm)	6.50 +/-0.10	9.00 +/-0.10	16.0 +/-0.30	1.50 +/-0.10	Min 1.5	1.75 +/-0.10	14.25 +/-0.10	7.50 +/-0.10	8.00 +/-0.10	4.00 +/-0.10	2.10 +/-0.10	0.30 +/-0.05	13.30 +/-0.10	0.055 +/-0.005

SOIC 14L Reel  
Configuration: Figure 4.0

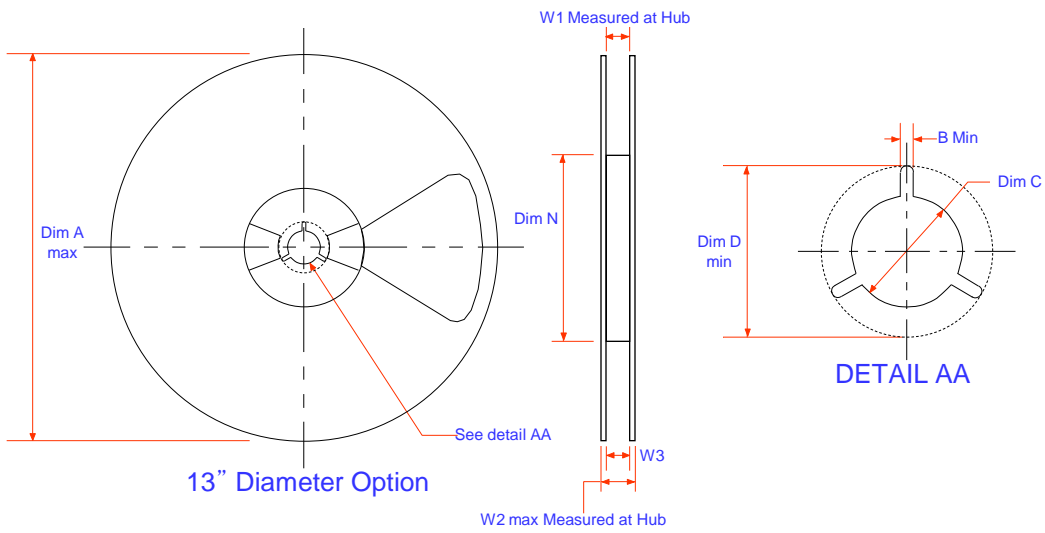

Dimensions are in inches and millimeters

Tape Size	Reel Option	Dim A	Dim B	Dim C	Dim D	Dim N	Dim W1	Dim W2	Dim W3 (LSL-USL)
16mm	13" Dia	13.00 330	0.059 1.5	0.512 +0.020/-0.008 13 +0.5/-0.2	0.795 20.2	4.00 100	0.646 +0.078/-0.000 16.4 +2/0	0.882 22.4	0.646+0.118/-0.197 16.4+3/-0.5

NOTES:

- A. ALL DIMENSION ARE IN MILLIMETERS UNLESS OTHERWISE SPECIFIED
- B. DRAWING FILE NAME:PKG-M14ARev1
- C. PLASTIC REEL W1 DIMENSION CONTROL LIMITS:  
8MM REEL = +/-1.0MM AND 12MM REEL AND ABOVE = +/- 1.5MM

## SOIC 14L Tube Packing Configuration: Figure 1.0

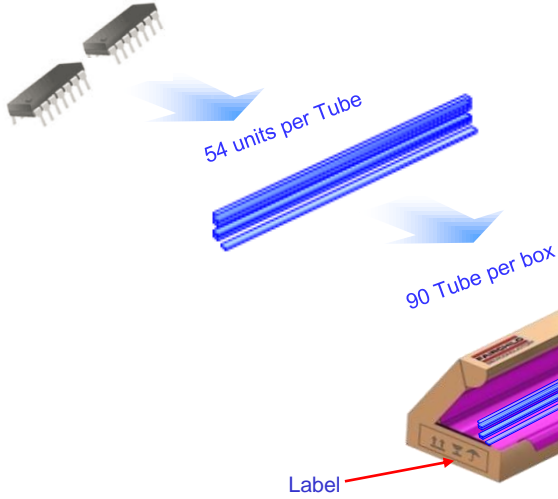

### Packing Description:

SOIC 14L parts are shipped normally in tube. The tube is made of PVC plastic treated with anti-static agent. These tubes in standard option are placed inside a dissipative plastic bubble sheet, barcode labeled, and placed inside a box made of recyclable corrugated paper. One box contains 90 tubes maximum (see fig. 1.0). And one or several of these boxes are placed inside a labeled shipping box which comes in different sizes depending on the number of parts shipped.

## SOIC 14L Packing Configuration : Figure 2.0

SOIC 14L Packing Information	
Packing Option	Standard
Packing Type	Tube
Qty per Tube	54
Inner Box Dimension (mm)	524*140*63
Max qty per Inner Box	4860
Max qty per outer Box	48600
Weight per unit (gm)	-
Note/Comments	

### Inner Box Barcode Label Sample

LOT:	AR	QTY:
FSID:		SPEC:
DIC1:	QTY1:	SPEC REV:
DIC2:	QTY2:	Pb-free
		RoHS COMPLIANT
		2nd Level Interconnect:
		1.Category e3
		2.Maximum safe temperature 360C
		3.MSL N/A
FAIRCHILD SEMICONDUCTOR <sup>®</sup> (CHINA)		

### Outer Box Barcode Label Sample

PART ID:	LOT:	QTY: 6400
		2013/02/01 08:33:54
	D.C:	BG FS00130
	SM13B11526	
FAIRCHILD SEMICONDUCTOR CORPORATION		(BBX) 1.2

## SOIC 14L Tube Configuration : Figure 3.0

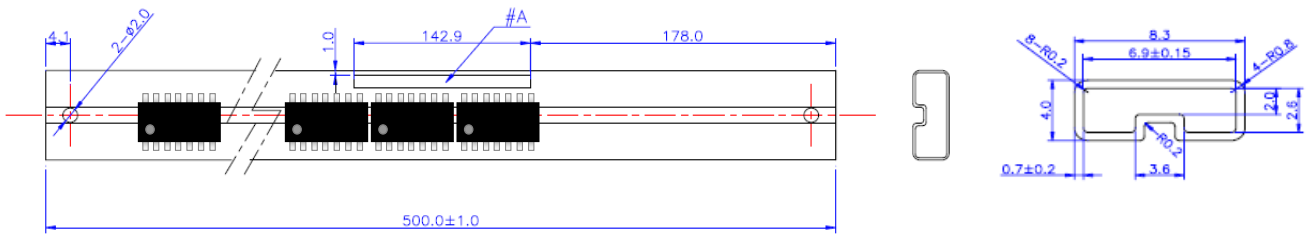

### NOTES:

A : ALL DIMENSION ARE IN MILLIMETERS UNLESS OTHERWISE SPECIFIED

B : DRAWING FILE NAME : PKG-M14ARev1