

SOT23-3L Packing Configuration: Figure 1.0

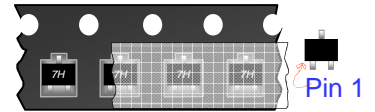
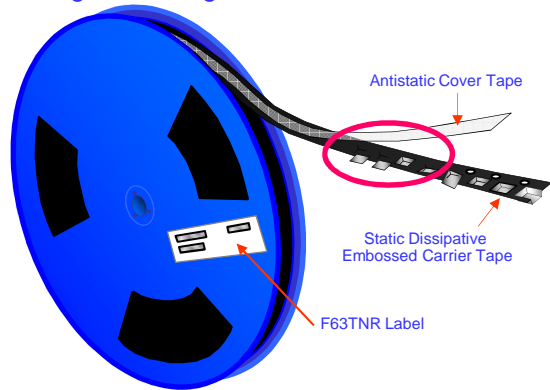

SOT23-3L Unit Orientation

Packing Description:

SOT23-3L parts are shipped in tape. The carrier tape is made from a dissipative (carbon filled) polycarbonate resin. The cover tape is a multilayer film (Heat Activated Adhesive in nature) primarily composed of polyester film, adhesive layer, sealant, and anti-static sprayed agent. These reeled parts in standard option are shipped with 3,000 units per 7" or 17.7cm diameter reel. The reels are clear in color and is made of polystyrene plastic (anti-static coated). This and some other options are further described in the Packing Information table.

These full reels are individually barcode labeled and placed inside a standard intermediate box (illustrated in figure 1.0) made of recyclable corrugated brown paper. One box contains five reels maximum. And these boxes are placed inside a barcode labeled shipping box which comes in different sizes depending on the number of parts shipped.

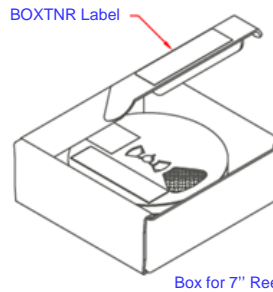

SOT23-3L Packing Information	
Packing Option	Standard
Packing type	TNR
Qty per Reel/Tube/Bag	3,000
Reel Size	7" Dia
Max qty per Box	15,000

Reel Barcode Label Sample_(F63TNR)



Inner Box Barcode Label Sample_(BOXTNR)



SOT23-3L Tape Leader and Trailer Configuration: Figure 2.0

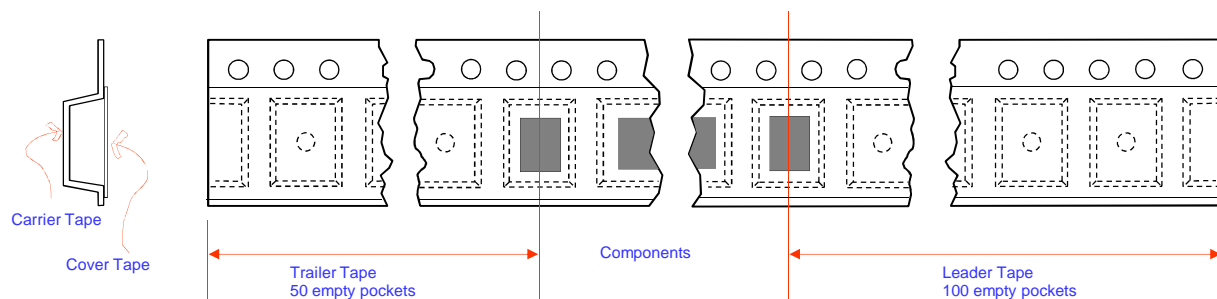

NOTES:

- A. ALL DIMENSION ARE IN MILLIMETERS UNLESS OTHERWISE SPECIFIED
- B. DRAWING FILE NAME: PKG-MA03DREV1

SOT23-3L Embossed Carrier Tape
 Configuration: Figure 3.0

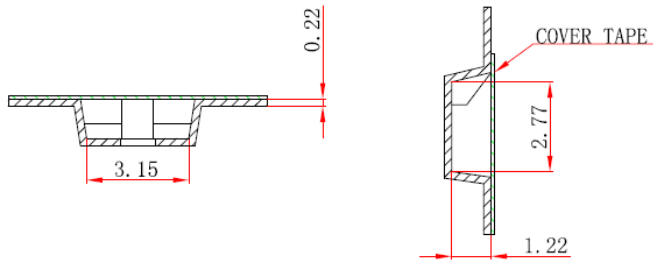
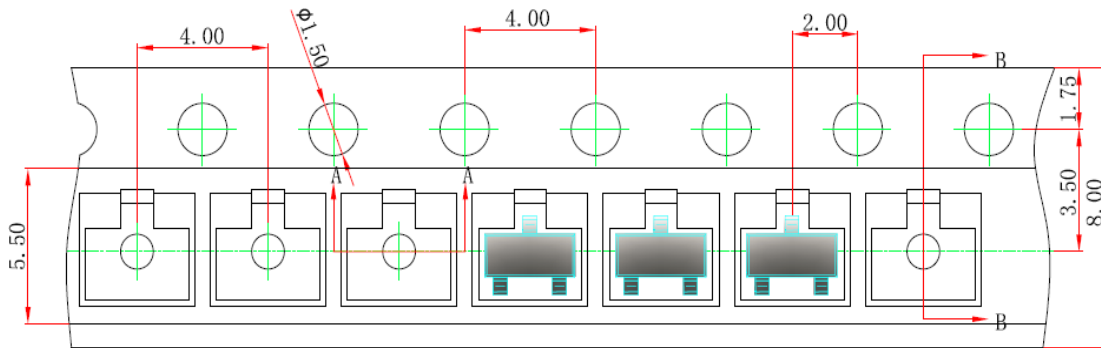

A - A

B - B

SOT23-3L Reel
 Configuration: Figure 4.0

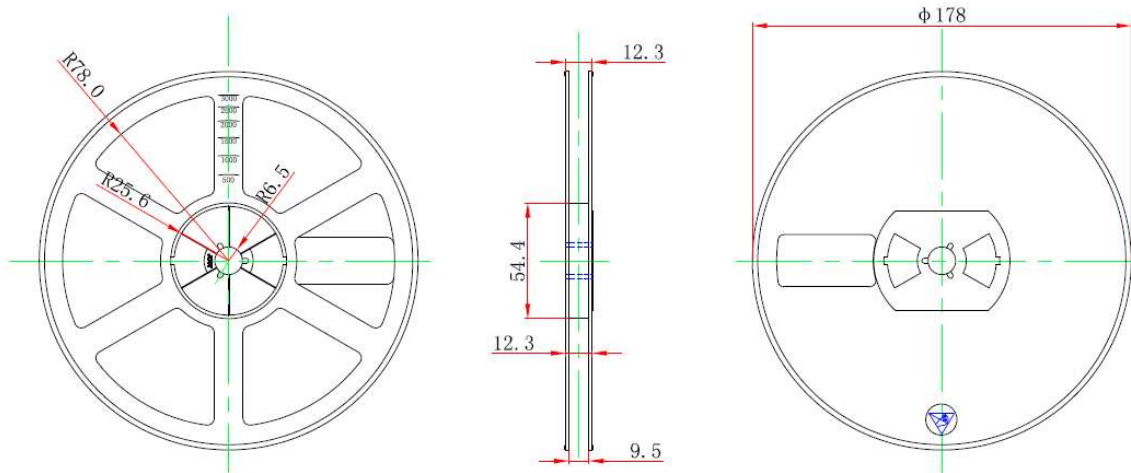

NOTES:

- A. ALL DIMENSION ARE IN MILLIMETERS UNLESS OTHERWISE SPECIFIED
- B. DRAWING FILE NAME: PKG-MA03DREV1