

Tape and Reel Packaging for Surface Mount Components

Rev. V16

Introduction

M/A-Com Technology Solutions supplies integrated circuits, diodes, and related surface mount components in tape wound on standard 7-inch, 8-inch, 10-inch, and 13-inch diameter reels. This application note documents the reel and tape dimensions and the orientation of the components within the tape cavities for over 75 of our most popular package styles.

Packages Covered in This Application Note:

Package Type	Comments
08-mm BGA	
15-mm BGA	
BD-1, BD-2, BD-3	Bumped Die
CR-5	
LCC1	
LSM1	
LSM2	
LSM3	
LSM6	
MSOP-8	Also MSOP-8EP
MSOP-10	
ODS-4	Axial Lead
ODS-54	Axial Lead
ODS-120	Ceramic
ODS-139	Axial Lead
ODS-146	Axial Lead
ODS-186	Ceramic
ODS-401	Axial Lead
ODS-402	Axial Lead
ODS-1056	Ceramic
ODS-1072	MELF
ODS-1079	MELF
ODS-1091	MELF
ODS-1294	Surmount
ODS-1295	Surmount
ODS-1306	Surmount
PDFN-6, 1.2 x 1.5 mm (0.5 mm pitch)	
PDFN-6, 1.5 x 1.2 mm (0.4 mm pitch)	
PDFN-8, 2mm (MO-229, VCCD-3)	
PQFN-12, 3mm (MO-220, VEED-1)	
PQFN-16, 3mm (MO-220, VEED-4, VEED-6)	
PQFN-16, 4mm (MO-220, VGGC)	
PQFN-20, 4mm (MO-220, VGGD-1)	
PQFN-24, 4mm (MO-220, VGGD-8)	
PQFN-20, 5mm (MO-220, VHHC)	
PQFN-28, 5mm (MO-220, VHHD-1)	
PQFN-32, 5mm (MO-220, VHHD-4, VHHD-5)	
PQFN-32, 6x4mm	
PQFN-32, 6x5mm	
PQFN-36, 7x4mm	
PQFN-37, 7x6mm	
QSOP-16	Also QSOP-16EP
QSOP-24	
QSOP-28	
R-1, R-4, R-5, R-15	

Package Type	Comments
SC-70, SOT-323, SOT-353, SOT-363	
SC-79	
SM-1	
SM-2	
SM-3	
SM-4	
SM-7-1	
SM-20	
SM-22	
SM-23	
SM-24	
SM-26	
SM-28	
SM-41	
SM-44	
SM-46	
SM-52	
SM-55	
SM-68	Same as SM-44
SM-69	Same as SM-1
SM-74	Same as SM-2
SM-87	Same as SM-1
SM-89	Same as SM-1
SM-106	Same as SM-2
SM-108	Same as SM-2
SM-134	Same as SM-1
SOD-323	
SOIC-8	
SOIC-14	
SOIC-16	
SOIC-24, SO-24	
SOT-23 (3L)	
SOT-25 (5L)	Same as SOT-23 (5L)
SOT-26 (6L)	Same as SOT-23 (6L)
SOT-89	
SOT-143 (4L)	
SOW-16	Also SOIC-16 Wide Body
SSOP-8	
SSOP-20	
SSOP-24	
SSOP-28	
STDFN-8, 2mm	
STQFN-12, 2mm	
STQFN-14, 2 x 2.5mm	
TSSOP-16	Also TSSOP-16EP
X1DFN-6, 1mm	

1

M/A-COM Technology Solutions Inc. and its affiliates reserve the right to make changes to the product(s) or information contained herein without notice.

• North America Tel: 800.366.2266 • Europe Tel: +353.21.244.6400
 • India Tel: +91.80.43537383 • China Tel: +86.21.2407.1588
 Visit www.macomtech.com for additional data sheets and product information.

Reel Dimensions

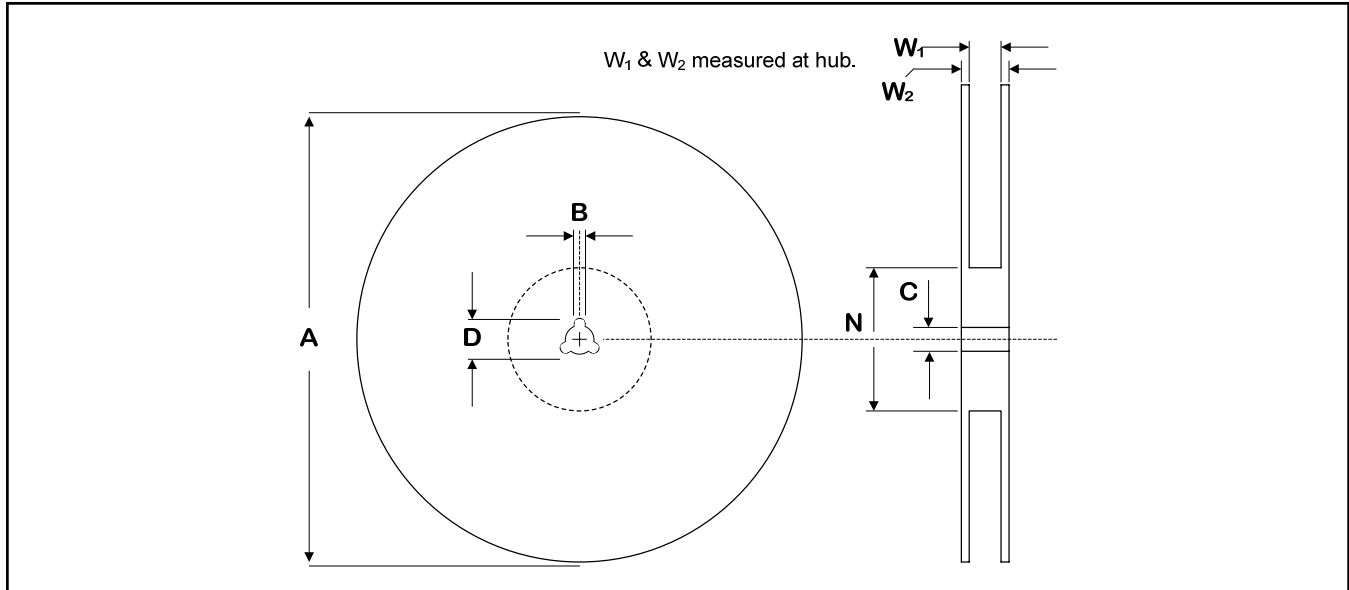

8-mm BGA

		Reel Size:	13-inch Reel		7-inch Reel	
	Item	Symbol	Size (inch)	Size (mm)	Size (inch)	Size (mm)
Flange	Diameter	A	13.000 ± 0.079	330.0 ± 2.0	7.000 ± 0.079	178.0 ± 2.0
	Thickness	W ₂	0.874 Max.	22.2 Max.	0.882 Max.	22.4 Max.
	Space Between Flanges	W ₁	0.661 ± 0.059, -0.0	16.8 ± 1.5, -0.0	0.65 ± 0.059, -0.0	16.4 ± 1.5, -0.0
Hub	Outer Diameter	N	4.016 Min.	102.0 Min.	2.36 Min.	60.0 Min.
	Spindle Hole Diameter	C	0.512 ± 0.008	13.0 ± 0.2	0.512 ± 0.008	13.0 ± 0.2
	Key Slit Width	B	0.059 Min.	1.5 Min.	0.079 Min.	2.0 Min.
	Key Slit Diameter	D	0.795 Min.	20.2 Min.	0.795 Min.	20.2 Min.

15-mm BGA

		Reel Size:	13-inch Reel		7-inch Reel	
	Item	Symbol	Size (inch)	Size (mm)	Size (inch)	Size (mm)
Flange	Diameter	A	13.000 ± 0.079	330.0 ± 2.0	7.000 ± 0.079	178.0 ± 2.0
	Thickness	W ₂	1.189	30.2	1.197	30.4 Max.
	Space Between Flanges	W ₁	0.976 ± 0.024, -0.016	24.8 ± 0.6, -0.4	0.961 ± 0.079, -0.0	24.4 ± 2.0, -0.0
Hub	Outer Diameter	N	4.016	102	2.36 ± 0.039	60 ± 1.0
	Spindle Hole Diameter	C	0.512 ±, -0.008	13 ± 0.5, -0.2	0.512 ± 0.079	13 ± 2.0
	Key Slit Width	B	0.079 ± 0.020	2 ± 0.5	0.08 Min.	2 Min.
	Key Slit Diameter	D	0.795 Min.	20.2 Min.	0.795 Min.	20.2 Min.

Tape and Reel Packaging for Surface Mount Components

Rev. V16

BD-1, BD-2, BD-3

		Reel Size:		7-inch Reel	
	Item	Symbol	Size (inch)	Size (mm)	
Flange	Diameter	A	7.000 ± 0.079	178.0 ± 2.0	
	Thickness	W ₂	0.567 Max.	14.4 Max.	
	Space Between Flanges	W ₁	0.331 ± 0.059, -0.0	8.4 ± 1.5, -0.0	
Hub	Outer Diameter	N	2.16 ± 0.02	55.0 ± 0.5	
	Spindle Hole Diameter	C	0.512 ± .020/-0.008	13.0 ± 0.5/-0.2	
	Key Slit Width	B	0.059 Min.	1.5 Min.	
	Key Slit Diameter	D	0.795 Min.	20.2 Min.	

CR-5

		Reel Size:		13-inch Reel		7-inch Reel	
	Item	Symbol	Size (inch)	Size (mm)	Size (inch)	Size (mm)	
Flange	Diameter	A	13.000 ± 0.079	330.0 ± 2.0	7.000 ± 0.079	178.0 ± 2.0	
	Thickness	W ₂	10.189 Max.	30.2 Max.	1.197 Max.	30.4 Max.	
	Space Between Flanges	W ₁	0.976 ± 0.059, -0.0	24.8 ± 1.5, -0.0	0.961 ± 0.059, -0.0	24.4 ± 1.5, -0.0	
Hub	Outer Diameter	N	4.02 Min.	102.0 Min.	2.36 Min.	60.0 Min.	
	Spindle Hole Diameter	C	0.512 ± 0.008	13.0 ± 0.2	0.512 ± 0.008	13.0 ± 0.2	
	Key Slit Width	B	0.079 Min.	2 Min.	0.079 Min.	2 Min.	
	Key Slit Diameter	D	0.795 Min.	20.2 Min.	0.795 Min.	20.2 Min.	

LCC1

		Reel Size:		13-inch Reel		7-inch Reel	
	Item	Symbol	Size (inch)	Size (mm)	Size (inch)	Size (mm)	
Flange	Diameter	A	13.000 ± 0.079	330.0 ± 2.0	7.002 ± 0.079	178.0 ± 2.0	
	Thickness	W ₂	1.189	30.2	1.197 Max.	30.4 Max.	
	Space Between Flanges	W ₁	0.976 ± 0.024, -0.016	24.8 ± 0.6, -0.4	0.961 ± 0.078, -0.0	22.4 ± 2.0, -0.0	
Hub	Outer Diameter	N	4.02 Min.	102.0 Min.	2.36 Min.	60.0 Min.	
	Spindle Hole Diameter	C	0.512 ± 0.008	13.0 ± 0.2	0.512 ± 0.008	13.0 ± 0.2	
	Key Slit Width	B	0.079 Min.	2 Min.	0.079 Min.	2 Min.	
	Key Slit Diameter	D	0.795 Min.	20.2 Min.	0.795 Min.	20.2 Min.	

Tape and Reel Packaging for Surface Mount Components

Rev. V16

LSM1, LSM2, LSM3, LSM6

		Reel Size:		13-inch Reel	
	Item	Symbol	Size (inch)	Size (mm)	
Flange	Diameter	A	13.0 ± 0.079	330.0 ± 2.0	
	Thickness	W ₂	1.197 Max.	30.4 Max.	
	Space Between Flanges	W ₁	0.961 ± 0.079, -0.0	24.4 ± 2.0, -0.0	
Hub	Outer Diameter	N	4.0 Min.	101.6 Min.	
	Spindle Hole Diameter	C	0.512 ± 0.020	13.0 ± 0.5	
	Key Slit Width	B	0.059 Min.	1.5 Min.	
	Key Slit Diameter	D	0.795 Min.	20.2 Min.	

MSOP-8, MSOP-8EP, MSOP-10, SOIC-8 (SO-8)

		Reel Size:		13-inch Reel		7-inch Reel	
	Item	Symbol	Size (inch)	Size (mm)	Size (inch)	Size (mm)	
Flange	Diameter	A	13.000 ± 0.079	330.0 ± 2.0	7.002 ± 0.079	178.0 ± 2.0	
	Thickness	W ₂	0.717 Max.	18.2 Max	0.724 Max.	18.4 Max.	
	Space Between Flanges	W ₁	0.504±0.080, -0.0	12.8 ±2.0, -0.0	0.488 ±0.080, -0.0	12.4 ±2.0, -0.0	
Hub	Outer Diameter	N	2.48 Min.	102.0 Min.	21 Min.	60.0 Min.	
	Spindle Hole Diameter	C	0.512 ± 0.008	13.0 ± 0.2	0.512 ± 0.008	13.0 ± 0.2	
	Key Slit Width	B	0.079 Min.	2 Min.	0.079 Min.	2 Min.	
	Key Slit Diameter	D	0.795 Min.	20.2 Min.	0.795 Min.	20.2 Min.	

ODS-4, ODS-54, ODS-139, ODS-146

		Reel Size:		10-inch Reel		8-inch Reel	
	Item	Symbol	Size (inch)	Size (mm)	Size (inch)	Size (mm)	
Flange	Diameter	A	10.00 ± 0.062	254.00 ± 1.57	8.00 ± 0.062	203.20 ± 1.57	
	Thickness	W ₂	3.25 Max.	82.55 Max.	3.25 Max.	82.55 Max.	
	Space Between Flanges	W ₁	2.75 ± 0.062	69.85 ± 1.57	2.75 ± 0.062	69.85 ± 1.57	
Hub	Outer Diameter	N	3.25 ± 0.062	82.55 ± 1.57	3.25 ± 0.062	82.55 ± 1.57	
	Spindle Hole Diameter	C	0.625 ± 0.062	15.88 ± 1.57	0.625 ± 0.062	15.88 ± 1.57	
	Key Slit Width	B	N/A	N/A	N/A	N/A	
	Key Slit Diameter	D	0.312 ± 0.062	7.92 ± 1.57	0.312 ± 0.062	7.92 ± 1.57	

Tape and Reel Packaging for Surface Mount Components

Rev. V16

ODS-120

		Reel Size:		13-inch Reel		7-inch Reel	
	Item	Symbol	Size (inch)	Size (mm)	Size (inch)	Size (mm)	
Flange	Diameter	A	13.00 ± 0.079	330.0 ± 2.0	7.01 ± 0.079	178 ± 2.0	
	Thickness	W ₂	0.57 Max.	14.4 Max.	0.57 Max.	14.4 Max.	
	Space Between Flanges	W ₁	0.33 ± .059,-0.0	8.4 ± 1.5, -0.0	0.33 ±.059,-0.0	8.4 ± 1.5, -0.0	
Hub	Outer Diameter	N	2.48 Min.	63 Min.	2.17 ± 0.020	55.0 ± 0.50	
	Spindle Hole Diameter	C	0.512 ± 0.008	13.00 ± 0.20	0.512 ± 0.008	13.00 ± 0.20	
	Key Slit Width	B	0.079 ± 0.020	2.0 ± 0.5	0.079 ± 0.020	2.0 ± 0.5	
	Key Slit Diameter	D	0.795 ± 0.5, -0.0	20.2 ± 0.5, -0.0	0.795 ± .020, -0.0	20.2 ± 0.5, -0.0	

ODS-186

		Reel Size:		13-inch Reel		7-inch Reel	
	Item	Symbol	Size (inch)	Size (mm)	Size (inch)	Size (mm)	
Flange	Diameter	A	13.000 ± 0.079	330.0 ± 2.0	7.000 ± 0.079	178.0 ± 2.0	
	Thickness	W ₂	0.87 Max.	22.2 Max.	0.882 Max.	22.4 Max.	
	Space Between Flanges	W ₁	0.66 ± 0.080, -0.0	16.8 ± 2.0, -0.0	0.65 ± 0.080, -0.0	16.4 ± 2.0, -0.0	
Hub	Outer Diameter	N	4.02 Min.	102.0 Min.	2.36 Min.	60.0 Min.	
	Spindle Hole Diameter	C	0.512 ± 0.008	13.0 ± 0.2	0.512 ± 0.008	13.0 ± 0.2	
	Key Slit Width	B	0.079 Min.	2 Min.	0.079 Min.	2 Min.	
	Key Slit Diameter	D	0.795 Min.	20.2 Min.	0.795 Min.	20.2 Min.	

ODS-401, ODS-402

		Reel Size:		10-inch Reel		8-inch Reel	
	Item	Symbol	Size (inch)	Size (mm)	Size (inch)	Size (mm)	
Flange	Diameter	A	10.00 ± 0.062	254.00 ± 1.57	8.00 ± 0.062	203.20 ± 1.57	
	Thickness	W ₂	3.25 Max.	82.55 Max.	3.25 Max.	82.55 Max.	
	Space Between Flanges	W ₁	2.75 ± 0.062	69.85 ± 1.57	2.75 ± 0.062	69.85 ± 1.57	
Hub	Outer Diameter	N	3.25 ± 0.062	82.55 ± 1.57	3.25 ± 0.062	82.55 ± 1.57	
	Spindle Hole Diameter	C	0.625 ± 0.062	15.88 ± 1.57	0.625 ± 0.062	15.88 ± 1.57	
	Key Slit Width	B	N/A	N/A	N/A	N/A	
	Key Slit Diameter	D	0.312 ± 0.062	7.92 ± 1.57	0.312 ± 0.062	7.92 ± 1.57	

Tape and Reel Packaging for Surface Mount Components

Rev. V16

ODS-1056

		Reel Size:		13-inch Reel		7-inch Reel	
	Item	Symbol	Size (inch)	Size (mm)	Size (inch)	Size (mm)	
Flange	Diameter	A	13.000 ± 0.079	330.0 ± 2.0	7.000 ± 0.079	178.0 ± 2.0	
	Thickness	W ₂	0.567 Max.	14.4 Max.	0.567 Max.	14.4 Max.	
	Space Between Flanges	W ₁	0.331 ± 0.059, -0.0	8.4 ± 1.5, -0.0	0.331 ± 0.059, -0.0	8.4 ± 1.5, -0.0	
Hub	Outer Diameter	N	2.48 min.	63.0 min.	2.17 ± 0.02, -0.0	55.0 ± 0.50, -0.0	
	Spindle Hole Diameter	C	0.512 ± 0.008	13.0 ± 0.2	0.512 ± 0.008	13.0 ± 0.2	
	Key Slit Width	B	0.059 Min.	1.5 Min.	0.059 Min.	1.5 Min.	
	Key Slit Diameter	D	0.795 Min.	20.2 Min.	0.795 Min.	20.2 Min.	

ODS-1072, ODS-1079, ODS-1091

		Reel Size:		13-inch Reel		7-inch Reel	
	Item	Symbol	Size (inch)	Size (mm)	Size (inch)	Size (mm)	
Flange	Diameter	A	13.0 ± 0.02	330.2 ± 0.5	7.0 ± 0.02	177.8 ± 0.5	
	Thickness	W ₂	0.724 Max.	18.4 Max.	0.724 Max.	18.4 Max.	
	Space Between Flanges	W ₁	0.472 ± .08, -0.0	12.0 ± 2.0, -0.0	0.472 ± .08, -0.0	12.4 ± 2.0, -0.0	
Hub	Outer Diameter	N	3.9 ± 0.008	100.0 ± 0.2	3.9 ± 0.008	55.0 ± 0.50	
	Spindle Hole Diameter	C	0.512 ± 0.008	13.0 ± 0.2	0.512 ± 0.008	13.0 ± 0.2	
	Key Slit Width	B	0.079 ± 0.02	2.0 ± 0.5	0.079 ± 0.02	2.0 ± 0.5	
	Key Slit Diameter	D	0.795 ± 0.02, -0.0	20.2 ± 0.5, -0.0	0.795 ± 0.02, -0.0	20.2 ± 0.5, -0.0	

ODS-1294, ODS-1295, ODS-1306

		Reel Size:		7-inch Reel	
	Item	Symbol	Size (inch)	Size (mm)	
Flange	Diameter	A	7.0 ± 0.02	178 ± 0.5	
	Thickness	W ₂	0.57 Max.	14.4 Max.	
	Space Between Flanges	W ₁	0.33 ± 0.059, -0.0	8.4 ± 1.5, -0.0	
Hub	Outer Diameter	N	2.17 ± 0.020	55.0 ± 0.50	
	Spindle Hole Diameter	C	0.512 ± 0.008	13.0 ± 0.2	
	Key Slit Width	B	0.059 min.	1.5 min.	
	Key Slit Diameter	D	0.795 min.	20.2 min.	

Tape and Reel Packaging for Surface Mount Components

Rev. V16

PDFN-6, 1.2 x 1.5 mm (0.5 mm Lead Pitch) & 1.5 x 1.2 mm (0.4 mm Lead Pitch)

		Reel Size:		7-inch Reel	
	Item	Symbol	Size (inch)	Size (mm)	
Flange	Diameter	A	7.000 ± 0.079	178.0 ± 2.0	
	Thickness	W ₂	0.567 Max.	14.4 Max.	
	Space Between Flanges	W ₁	0.331 ± 0.059, -0.0	8.4 ± 1.5, -0.0	
Hub	Outer Diameter	N	2.16 ± 0.02	55.0 ± 0.5	
	Spindle Hole Diameter	C	0.512 ± .020/-0.008	13.0 ± 0.5/-0.2	
	Key Slit Width	B	0.059 Min.	1.5 Min.	
	Key Slit Diameter	D	0.795 Min.	20.2 Min.	

PDFN-8, 2 mm (MO-229, VCCD-3)

		Reel Size:		13-inch Reel	
	Item	Symbol	Size (inch)	Size (mm)	
Flange	Diameter	A	13 ± 0.012/-0.157	330 ± 0.3/-4.0	
	Thickness	W ₂	0.724 Max	18.4 Max.	
	Space Between Flanges	W ₁	0.488 ± 0.079/-0.0	12.4 ± 2.0/-0.0	
Hub	Outer Diameter	N	3.858 Min.	98 Min.	
	Spindle Hole Diameter	C	0.512 ± .008	13.0 ± 0.2	
	Key Slit Width	B	0.087 ± .008	2.2 ± 0.2	
	Key Slit Diameter	D	0.835 ± .008	21.2 ± 0.2	

PQFN-12, 3 mm (MO-220, VEED-1), PQFN-16, 3 mm (MO-220, VEED-4, VEED-6), PQFN-16, 4 mm (MO-220, VGGC), PQFN-20, 4 mm, PQFN-24, 4 MM (MO-220, VGGD-1), PQFN-20, 5 mm (MO-220, VHHC), PQFN-28, 5 mm (MO-220, VHHD-1), PQFN-32, 5mm (MO-220, VHHD-4, VHHD-5)

		Reel Size:		13-inch Reel		7-inch Reel	
	Item	Symbol	Size (inch)	Size (mm)	Size (inch)	Size (mm)	
Flange	Diameter	A	13.000 ± 0.079	330.0 ± 2.0	7.000 ± 0.079	178.0 ± 2.0	
	Thickness	W ₂	0.717 Max.	18.2 Max.	0.724 Max.	18.4 Max.	
	Space Between Flanges	W ₁	0.504 ± 0.059, -0.0	12.8 ± 1.5, -0.0	0.472 ± 0.059, -0.0	12.4 ± 1.5, -0.0	
Hub	Outer Diameter	N	4.016 Min.	102.0 Min.	2.36 Min.	60.0 Min.	
	Spindle Hole Diameter	C	0.512 ± 0.008	13.0 ± 0.2	0.512 ± 0.008	13.0 ± 0.2	
	Key Slit Width	B	0.079 Min.	2 Min.	0.079 Min.	2 Min.	
	Key Slit Diameter	D	0.795 Min.	20.2 Min.	0.795 Min.	20.2 Min.	

Tape and Reel Packaging for Surface Mount Components

Rev. V16

QSOP-16, QSOP-16EP, QSOP-24, QSOP-28

		Reel Size:		13-inch Reel		7-inch Reel	
	Item	Symbol	Size (inch)	Size (mm)	Size (inch)	Size (mm)	
Flange	Diameter	A	13.000 ± 0.079	330.0 ± 2.0	7.000 ± 0.079	178.0 ± 2.0	
	Thickness	W ₂	0.560 Max.	14.2 Max.	0.567 Max.	14.4 Max.	
	Space Between Flanges	W ₁	0.346 ± 0.059, -0.0	8.8 ± 1.5, -0.0	0.331 ± 0.059, -0.0	8.4 ± 1.5, -0.0	
Hub	Outer Diameter	N	2.48 Min.	63.0 Min.	2.16 Min.	55.0 Min.	
	Spindle Hole Diameter	C	0.512 ± 0.008	13.0 ± 0.2	0.512 ± 0.008	13.0 ± 0.2	
	Key Slit Width	B	0.059 Min.	1.5 Min.	0.059 Min.	1.5 Min.	
	Key Slit Diameter	D	0.795 Min.	20.2 Min.	0.795 Min.	20.2 Min.	

R-1, R-4, R-5, R-15, SM-1, SM-2, SM-3, SM-4, SM-7-1, SM-20, SM-22, SM-23, SM-24, SM-26, SM-28, SM-41, SM-44, SM-46, SM-52, SM-55, SM-68, SM-69, SM-74, SM-87, SM-89, SM-106, SM-108, SM-134

		Reel Size:		13-inch Reel	
	Item	Symbol	Size (inch)	Size (mm)	
Flange	Diameter	A	13.000 ± 0.079	330.0 ± 2.0	
Hub	Outer Diameter	N	2.36 Min.	60.0 Min.	
	Spindle Hole Diameter	C	0.512 ± 0.020	13.0 ± 0.2	
	Key Slit Width	B	0.059 Min.	1.5 Min.	
	Key Slit Diameter	D	0.795 Min.	20.2 Min.	

SC-70, SOT-323 (3-lead), SOT-353 (5-lead), and SOT-363 (6-lead)

		Reel Size:		13-inch Reel		7-inch Reel	
	Item	Symbol	Size (inch)	Size (mm)	Size (inch)	Size (mm)	
Flange	Diameter	A	13.000 ± 0.079	330.0 ± 2.0	7.000 ± 0.079	178.0 ± 2.0	
	Thickness	W ₂	0.56 Max.	14.2 Max.	0.57 Max.	14.4 Max.	
	Space Between Flanges	W ₁	0.35 ± 0.02	8.8 ± 0.6, - 0.4	0.33 ± 0.07, - 0.00	8.4 ± 1.5, - 0.0	
Hub	Outer Diameter	N	4.02 Min.	102.0 Min.	2.36 Min.	60.0 Min.	
	Spindle Hole Diameter	C	0.512 ± 0.008	13.0 ± 0.2	0.512 ± 0.008	13.0 ± 0.2	
	Key Slit Width	B	0.079 ± 0.02	2.0 ± 0.5	0.079 ± 0.02.	2.0 ± 0.5.	
	Key Slit Diameter	D	0.795 Min.	20.2 Min.	0.795 Min.	20.2 Min.	

Tape and Reel Packaging for Surface Mount Components

Rev. V16

SC-79, SOD-323

		Reel Size:		7-inch Reel	
	Item	Symbol	Size (inch)	Size (mm)	
Flange	Diameter	A	7.000 ± 0.079	178.0 ± 2.0	
	Thickness	W ₂	0.567 Max.	14.4 Max.	
	Space Between Flanges	W ₁	0.374 ± .039	9.5 ± 1.00	
Hub	Outer Diameter	N	2.36 Min.	60.0 Min.	
	Spindle Hole Diameter	C	0.512 ± 0.008	13.0 ± 0.2	
	Key Slit Width	B	0.079 Min.	2 Min.	
	Key Slit Diameter	D	0.795 Min.	20.2 Min.	

SOT-23, SOT-25, SOT-26, SOT-89, SOT-143

		Reel Size:		13-inch Reel		7-inch Reel	
	Item	Symbol	Size (inch)	Size (mm)	Size (inch)	Size (mm)	
Flange	Diameter	A	13.000 ± 0.079	330.0 ± 2.0	7.002 ± 0.079	178.0 ± 2.0	
	Thickness	W ₂	0.560 Max.	14.2 Max.	0.567 Max.	14.4 Max.	
	Space Between Flanges	W ₁	0.346 ± 0.059, -0.0	8.8 ± 1.5, -0.0	0.331 ± 0.059, -0.0	8.4 ± 1.5, -0.0	
Hub	Outer Diameter	N	4.016 Min.	102.0 Min.	2.36 Min.	60.0 Min.	
	Spindle Hole Diameter	C	0.512 ± 0.008	13.0 ± 0.2	0.512 ± 0.008	13.0 ± 0.2	
	Key Slit Width	B	0.079 Min.	2 Min.	0.079 Min.	2 Min.	
	Key Slit Diameter	D	0.795 Min.	20.2 Min.	0.795 Min.	20.2 Min.	

SOIC-14 (SO-14), SOIC-16 (SO-16 & SOW-16), SSOP-8, SSOP-20, SSOP-24, SSOP-28, TSSOP-16, TSSOP-16EP

		Reel Size:		13-inch Reel		7-inch Reel	
	Item	Symbol	Size (inch)	Size (mm)	Size (inch)	Size (mm)	
Flange	Diameter	A	13.000 ± 0.079	330.0 ± 2.0	7.002 ± 0.079	178.0 ± 2.0	
	Thickness	W ₂	0.874 Max.	22.2 Max.	0.882 Max.	22.4 Max.	
	Space Between Flanges	W ₁	0.661 ± 0.080, -0.0	16.8 ± 2.0, -0.0	0.646 ± 0.080, -0.0	16.4 ± 2.0, -0.0	
Hub	Outer Diameter	N	4.016 Min.	102.0 Min.	2.36 Min.	60.0 Min.	
	Spindle Hole Diameter	C	0.512 ± 0.008	13.0 ± 0.2	0.512 ± 0.008	13.0 ± 0.2	
	Key Slit Width	B	0.079 Min.	2 Min.	0.079 Min.	2 Min.	
	Key Slit Diameter	D	0.795 Min.	20.2 Min.	0.795 Min.	20.2 Min.	

Tape and Reel Packaging for Surface Mount Components

Rev. V16

SOIC-24 (SO-24, SOW-24)

		Reel Size:	13-inch Reel	
	Item	Symbol	Size (inch)	Size (mm)
Flange	Diameter	A	14.173 Max.	360.0 Max.
	Thickness	W ₂	1.189 Max.	30.2 Max.
	Space Between Flanges	W ₁	0.976 ±0.078, -0.0	22.8 ±2.0, -0.0
Hub	Outer Diameter	N	4.016 Min.	102.0 Min.
	Spindle Hole Diameter	C	0.512 ± 0.008	13.0 ± 0.2
	Key Slit Width	B	0.079 Min.	2 Min.
	Key Slit Diameter	D	0.795 Min.	20.2 Min.

STDFN-8, 2 mm, STQFN-12, 2 mm, STQFN-14, 2x2.5 mm, X1DFN-6, 1 mm

		Reel Size:	7-inch Reel	
	Item	Symbol	Size (inch)	Size (mm)
Flange	Diameter	A	7 +0.098/-0.079	178 +2.5/-2.0
	Thickness	W ₂	0.567 Max.	14.4 Max.
	Space Between Flanges	W ₁	0.331 +0.059/-0.0	8.4 +1.5/-0.0
Hub	Outer Diameter	N	2.126 Min.	54 Min.
	Spindle Hole Diameter	C	.512 +0.020/-0.0079	13.0 +0.5/-0.2
	Key Slit Width	B	0.059 Min.	1.5 Min.
	Key Slit Diameter	D	0.795 Min.	20.2 Min.

Tape and Reel Packaging for Surface Mount Components

Rev. V16

Tape Dimensions 8, 12, 16, and 24 mm Tape Only

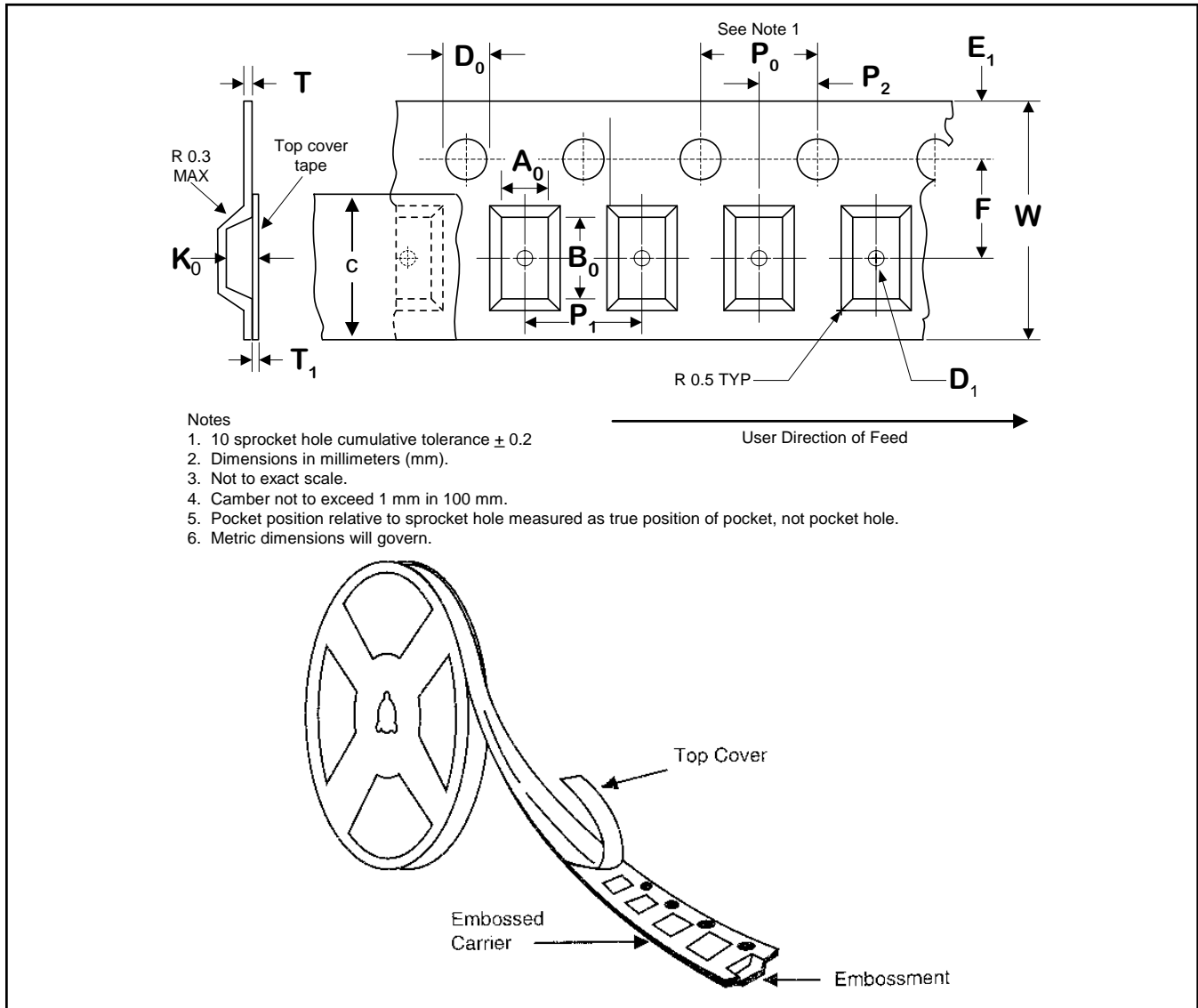

Fixed Dimensions

Tape Dimensions	Description	Symbol	Size (inches)	Size (mm)
Perforation	Diameter	D_0	$0.059 \pm 0.004, -0.000$	1.5 ± 0.1
	Pitch	P_0	1.57 ± 0.004	4.0 ± 0.1
	Position	E_1	0.069 ± 0.004	1.75 ± 0.10
	Thickness	T	0.010 ± 0.004	0.25 ± 0.10
Cover Tape	Thickness	T_1	0.0024 ± 0.0008	0.06 ± 0.02

Tape and Reel Packaging for Surface Mount Components

Rev. V16

8-mm BGA

Tape Dimensions	Description	Symbol	Size (inches)	Size (mm)
Cavity	Length	A ₀	0.327 ± 0.004	8.3 ± 0.10
	Width	B ₀	0.327 ± 0.004	8.3 ± 0.10
	Depth	K ₀	0.106 ± 0.004	2.7 ± 0.10
	Pitch	P ₁	0.472 ± 0.004	12 ± 0.10
Distance Between Centerlines	Cavity to Perforation (length direction)	P ₂	0.079 ± 0.004	2 ± 0.10
	Cavity to Perforation (width direction)	F	0.295 ± 0.004	7.5 ± 0.10
Cover Tape	Width	C	0.523 ± 0.004	13.3 ± 0.10
Carrier Tape	Width	W	0.630 ± .012	16 ± 0.30

15-mm BGA

Tape Dimensions	Description	Symbol	Size (inches)	Size (mm)
Cavity	Length	A ₀	0.602 ± 0.004	15.3 ± 0.10
	Width	B ₀	0.602 ± 0.004	15.3 ± 0.10
	Depth	K ₀	0.569 ± 0.004	3.8 ± 0.10
	Pitch	P ₁	0.787 ± 0.004	20 ± 0.10
Distance Between Centerlines	Cavity to Perforation (length direction)	P ₂	0.079 ± 0.004	2.0 ± 0.10
	Cavity to Perforation (width direction)	F	0.453 ± 0.004	11.5 ± 0.10
Cover Tape	Width	C	0.827 ± 0.004	21 ± 0.10
Carrier Tape	Width	W	0.945 ± 0.012	24 ± 0.30

BD-1

Tape Dimensions	Description	Symbol	Size (inches)	Size (mm)
Cavity	Length	A ₀	0.032 ± 0.002	0.82 ± 0.05
	Width	B ₀	0.032 ± 0.002	0.82 ± 0.05
	Depth	K ₀	0.016 ± 0.002	0.395 ± 0.05
	Pitch	P ₁	0.157 ± 0.004	4.0 ± 0.10
	Pocket Hole Diameter	D ₁	0.014 ± 0.002	0.35 ± 0.05
Distance Between Centerlines	Cavity to Perforation (length direction)	P ₂	0.079 ± 0.002	2.0 ± 0.05
	Cavity to Perforation (width direction)	F	0.138 ± 0.002	3.5 ± 0.05
Cover Tape	Width	C	0.209 ± 0.004	5.3 ± 0.10
Carrier Tape	Width	W	0.315 ± 0.004	8.0 ± 0.10

BD-2

Tape Dimensions	Description	Symbol	Size (inches)	Size (mm)
Cavity	Length	A ₀	0.043 ± 0.002	1.1 ± 0.05
	Width	B ₀	0.049 ± 0.002	1.25 ± 0.05
	Depth	K ₀	0.012 ± 0.001	0.298 ± 0.028
	Pitch	P ₁	0.157 ± 0.004	4.0 ± 0.10
	Pocket Hole Diameter	D ₁	0.020 ± 0.002	0.5 ± 0.05
Distance Between Centerlines	Cavity to Perforation (length direction)	P ₂	0.079 ± 0.002	2.0 ± 0.05
	Cavity to Perforation (width direction)	F	0.138 ± 0.002	3.5 ± 0.05
Cover Tape	Width	C	0.209 ± 0.004	5.3 ± 0.10
Carrier Tape	Width	W	0.315 +.012/-0.004	8.0 + 0.30/-0.10

Tape and Reel Packaging for Surface Mount Components

Rev. V16

BD-3

Tape Dimensions	Description	Symbol	Size (inches)	Size (mm)
Cavity	Length	A ₀	0.023 ± 0.002	0.58 ± 0.05
	Width	B ₀	0.028 ± 0.002	0.7 ± 0.05
	Depth	K ₀	0.014 ± 0.002	0.36 ± 0.05
	Pitch	P ₁	0.157 ± 0.004	4.0 ± 0.10
	Pocket Hole Diameter	D ₁	N/A	N/A
Distance Between Centerlines	Cavity to Perforation (length direction)	P ₂	0.079 ± 0.002	2.0 ± 0.05
	Cavity to Perforation (width direction)	F	0.138 ± 0.002	3.5 ± 0.05
Cover Tape	Width	C	0.209 ± 0.004	5.3 ± 0.10
Carrier Tape	Width	W	0.315 ± 0.004	8.0 ± 0.10

CR-5

Tape Dimensions	Description	Symbol	Size (inches)	Size (mm)
Cavity	Length	A ₀	0.355 ± 0.004	9.02 ± 0.10
	Width	B ₀	0.390 ± 0.004	9.91 ± 0.10
	Depth	K ₀	0.080 ± 0.004	2.03 ± 0.10
	Pitch	P ₁	0.472 ± 0.004	12.0 ± 0.10
Distance Between Centerlines	Cavity to Perforation (length direction)	P ₂	0.079 ± 0.004	2.0 ± 0.10
	Cavity to Perforation (width direction)	F	0.453 ± 0.004	11.5 ± 0.10
Cover Tape	Width	C	0.827 ± 0.004	21.0 ± 0.10
Carrier Tape	Width	W	0.945 ± 0.012	24.0 ± 0.30

LCC1

Tape Dimensions	Description	Symbol	Size (inches)	Size (mm)
Cavity	Length	A ₀	0.412	10.47
	Width	B ₀	0.439	11.15
	Depth	K ₀	0.133	3.38
	Pitch	P ₁	0.630	16.00
Distance Between Centerlines	Cavity to Perforation (length direction)	P ₂	0.079 ± 0.004	2.00 ± 0.10
	Cavity to Perforation (width direction)	F	0.453	11.50
Carrier Tape	Width	W	0.945	24.00

LSM1

Tape Dimensions	Description	Symbol	Size (inches)	Size (mm)
Cavity	Length	A ₀	0.512	13.00
	Width	B ₀	0.512	13.00
	Depth	K ₀	0.185	4.70
	Pitch	P ₁	0.630	16.00
Distance Between Centerlines	Cavity to Perforation (length direction)	P ₂	0.079 ± 0.004	2.00 ± 0.10
	Cavity to Perforation (width direction)	F	0.453	11.50
Carrier Tape	Width	W	0.945	24.00

Tape and Reel Packaging for Surface Mount Components

Rev. V16

LSM2

Tape Dimensions	Description	Symbol	Size (inches)	Size (mm)
Cavity	Length	A ₀	0.397	10.08
	Width	B ₀	0.602	15.29
	Depth	K ₀	0.155	3.94
	Pitch	P ₁	0.630	16.00
Distance Between Centerlines	Cavity to Perforation (length direction)	P ₂	0.079 ± 0.004	2.00 ± 0.10
	Cavity to Perforation (width direction)	F	0.453	11.50
Carrier Tape	Width	W	0.945	24.00

LSM3

Tape Dimensions	Description	Symbol	Size (inches)	Size (mm)
Cavity	Length	A ₀	0.432	10.97
	Width	B ₀	0.497	12.62
	Depth	K ₀	0.187	4.75
	Pitch	P ₁	0.630	16.00
Distance Between Centerlines	Cavity to Perforation (length direction)	P ₂	0.079 ± 0.004	2.00 ± 0.10
	Cavity to Perforation (width direction)	F	0.453	11.50
Carrier Tape	Width	W	0.945	24.00

LSM6

Tape Dimensions	Description	Symbol	Size (inches)	Size (mm)
Cavity	Length	A ₀	0.807	20.50
	Width	B ₀	0.59	15.00
	Depth	K ₀	0.16	4.1
	Pitch	P ₁	0.944	24.00
Distance Between Centerlines	Cavity to Perforation (length direction)	P ₂	0.079 ± 0.004	2.00 ± 0.10
	Cavity to Perforation (width direction)	F	0.453	11.50
Carrier Tape	Width	W	0.945	24.00

MSOP-8, MSOP-8EP, MSOP-10

Tape Dimensions	Description	Symbol	Size (inches)	Size (mm)
Cavity	Length	A ₀	0.209 ± 0.004	5.3 ± 0.10
	Width	B ₀	0.134 ± 0.004	3.4 ± 0.10
	Depth	K ₀	0.055 ± 0.004	1.4 ± 0.10
	Pitch	P ₁	0.315 ± 0.004	8.0 ± 0.10
Distance Between Centerlines	Cavity to Perforation (length direction)	P ₂	0.079 ± 0.004	2.0 ± 0.10
	Cavity to Perforation (width direction)	F	0.217 ± 0.004	5.5 ± 0.10
Cover Tape	Width	C	0.362 ± 0.004	9.2 ± 0.10
Carrier Tape	Width	W	0.472 ± .012	12 ± 0.30

Tape and Reel Packaging for Surface Mount Components

Rev. V16

ODS-4

Tape Dimensions	Description	Symbol	Size (inches)	Size (mm)
Cavity	Inside Tape Spacing	B ₀	2.062 ± .059	52.4 ± 1.5
	Component Pitch	P ₁	0.200 ± 0.020	5.0 ± 0.5
Carrier Tape	Width	W	0.250 ± .020	6.35 ± 0.5

ODS-54

Tape Dimensions	Description	Symbol	Size (inches)	Size (mm)
Cavity	Inside Tape Spacing	B ₀	2.062 ± .059	52.4 ± 1.5
	Component Pitch	P ₁	0.200 ± 0.020	5.0 ± 0.5
Carrier Tape	Width	W	0.250 ± .020	6.35 ± 0.5

ODS-120

Tape Dimensions	Description	Symbol	Size (inches)	Size (mm)
Cavity	Length	A ₀	0.056 - 0.070	1.42 - 1.79
	Width	B ₀	0.051 - 0.060	1.29 - 1.52
	Depth	K ₀	0.056 - 0.070	1.42 - 0.070
	Pitch	P ₁	0.157 ± 0.004	4.0 ± 0.1
Distance Between Centerlines	Cavity to Perforation (length direction)	P ₂	0.079 ± 0.002	2.0 ± 0.05
	Cavity to Perforation (width direction)	F	0.138 ± 0.002	3.50 ± 0.05
Cover Tape	Width	C	0.213 ± 0.004	5.4 ± 0.1
Carrier Tape	Width	W	0.315 ± .012, -0.00	8.0 ± 0.3, -0.0

ODS-139

Tape Dimensions	Description	Symbol	Size (inches)	Size (mm)
Cavity	Inside Tape Spacing	B ₀	2.062 ± 0.059	52.4 ± 1.5
	Component Pitch	P ₁	0.200 ± 0.020	5.0 ± 0.5
Carrier Tape	Width	W	0.250 ± 0.020	6.35 ± 0.5

ODS-146

Tape Dimensions	Description	Symbol	Size (inches)	Size (mm)
Cavity	Inside Tape Spacing	B ₀	2.062 ± 0.059	52.4 ± 1.5
	Component Pitch	P ₁	0.200 ± 0.020	5.0 ± 0.5
Carrier Tape	Width	W	0.250 ± 0.020	6.35 ± 0.5

Tape and Reel Packaging for Surface Mount Components

Rev. V16

ODS-186

Tape Dimensions	Description	Symbol	Size (inches)	Size (mm)
Cavity	Length	A ₀	0.367 ± 0.004	9.32 ± 0.1
	Width	B ₀	0.106 ± 0.004	2.7 ± 0.1
	Depth	K ₀	0.054 ± 0.004	1.37 ± 0.1
	Pitch	P ₁	0.472 ± 0.004	12.0 ± 0.1
Distance Between Centerlines	Cavity to Perforation (length direction)	P ₂	0.079 ± 0.004	2.0 ± 0.1
	Cavity to Perforation (width direction)	F	0.295 ± 0.004	7.50 ± 0.1
Cover Tape	Width	C	0.523 ± 0.004	13.3 ± 0.1
Carrier Tape	Width	W	0.630 ± 0.012	16.0 ± 0.1

ODS-401

Tape Dimensions	Description	Symbol	Size (inches)	Size (mm)
Cavity	Inside Tape Spacing	B ₀	2.062 ± 0.059	52.4 ± 1.5
	Component Pitch	P ₁	0.200 ± 0.020	5.0 ± 0.5
Carrier Tape	Width	W	0.250 ± 0.020	6.35 ± 0.5

ODS-402

Tape Dimensions	Description	Symbol	Size (inches)	Size (mm)
Cavity	Inside Tape Spacing	B ₀	2.062 ± 0.059	52.4 ± 1.5
	Component Pitch	P ₁	0.200 ± 0.020	5.0 ± 0.5
Carrier Tape	Width	W	0.250 ± 0.020	6.35 ± 0.5

ODS-1056

Tape Dimensions	Description	Symbol	Size (inches)	Size (mm)
Cavity	Length	A ₀	0.082 ± 0.004	2.0 ± 0.1
	Width	B ₀	0.081 ± 0.004	2.0 ± 0.1
	Depth	K ₀	0.047 ± 0.004	1.19 ± 0.1
	Pitch	P ₁	0.1575 ± 0.004	4.0 ± 0.1
Distance Between Centerlines	Cavity to Perforation (length direction)	P ₂	0.079 ± 0.002	2.0 ± 0.05
	Cavity to Perforation (width direction)	F	0.1378 ± 0.002	3.5 ± 0.05
Cover Tape	Width	C	0.212 ± 0.004	5.4 ± 0.1
Carrier Tape	Width	W	0.315 ± 0.012, -0.004	8.0 ± 0.3, -0.1

Tape and Reel Packaging for Surface Mount Components

Rev. V16

ODS-1072

Tape Dimensions	Description	Symbol	Size (inches)	Size (mm)
Cavity	Length	A ₀	0.100 ± 0.004	2.54 ± 0.1
	Width	B ₀	0.140 ± 0.004	3.56 ± 0.1
	Depth	K ₀	0.100 ± 0.004	2.54 ± 0.1
	Pitch	P ₁	0.157 ± 0.004	4.0 ± 0.1
Distance Between Centerlines	Cavity to Perforation (length direction)	P ₂	0.079 ± .002	2.0 ± 0.05
	Cavity to Perforation (width direction)	F	0.217 ± .002	5.5 ± 0.05
Cover Tape	Width	C	0.366 ± 0.004	9.3 ± 0.1
Carrier Tape	Width	W	0.472 ± .012	12.0 ± 0.3

ODS-1079

Tape Dimensions	Description	Symbol	Size (inches)	Size (mm)
Cavity	Length	A ₀	0.126 ± 0.004	3.2 ± 0.1
	Width	B ₀	0.215 ± 0.004	5.46 ± 0.1
	Depth	K ₀	0.123 ± 0.004	2.54 ± 0.1
	Pitch	P ₁	0.315 ± 0.004	8.0 ± 0.1
Distance Between Centerlines	Cavity to Perforation (length direction)	P ₂	0.079 ± 0.002	2.0 ± 0.05
	Cavity to Perforation (width direction)	F	0.217 ± 0.002	5.5 ± 0.05
Cover Tape	Width	C	0.366 ± 0.004	9.3 ± 0.1
Carrier Tape	Width	W	0.472 ± 0.012	12.0 ± 0.3

ODS-1091

Tape Dimensions	Description	Symbol	Size (inches)	Size (mm)
Cavity	Length	A ₀	0.165 ± 0.004	4.19 ± 0.1
	Width	B ₀	0.212 ± 0.004	5.38 ± 0.1
	Depth	K ₀	0.160 ± 0.004	4.06 ± 0.1
	Pitch	P ₁	0.315 ± 0.004	8.0 ± 0.1
Distance Between Centerlines	Cavity to Perforation (length direction)	P ₂	0.079 ± 0.002	2.0 ± 0.05
	Cavity to Perforation (width direction)	F	0.217 ± 0.002	5.5 ± 0.05
Cover Tape	Width	C	0.366 ± 0.004	9.3 ± 0.1
Carrier Tape	Width	W	0.472 ± 0.012	12.0 ± 0.3

Tape and Reel Packaging for Surface Mount Components

Rev. V16

ODS-1294,1295,1306

Tape Dimensions	Description	Symbol	Size (inches)	Size (mm)
Cavity	Length	A ₀	0.025 ± 0.002	0.63 ± 0.05
	Width	B ₀	0.044 ± 0.002	1.12 ± 0.05
	Depth	K ₀	0.010 ± 0.002	0.26 ± 0.06
	Pocket Hole	D ₁	0.020 ± 0.004	0.5 ± 0.10
	Pitch	P ₁	0.157 ± 0.004	4.0 ± 0.10
Distance Between Centerlines	Cavity to Perforation (length direction)	P ₂	0.079 ± 0.002	2.0 ± 0.05
	Cavity to Perforation (width direction)	F	0.138 ± 0.002	3.5 ± 0.05
Cover Tape	Width	C	0.213 ± 0.004	5.4 ± 0.10
Carrier Tape	Width	W	0.315 ± 0.012,-0.00	8.0 ± 0.3,-0.00

PDFN-6, 1.2 x 1.5 mm (0.5 mm Lead Pitch) & PDFN-6, 1.5 x 1.2 mm (0.4mm Lead Pitch)

Tape Dimensions	Description	Symbol	Size (inches)	Size (mm)
Cavity	Length	A ₀	0.069 ± 0.004	1.75 ± 0.10
	Width	B ₀	0.053 ± 0.004	1.35 ± 0.10
	Depth	K ₀	0.040 ± 0.004	1.02 ± 0.10
	Pitch	P ₁	0.157 ± 0.004	4.0 ± 0.10
Distance Between Centerlines	Cavity to Perforation (length direction)	P ₂	0.079 ± 0.002	2.0 ± 0.05
	Cavity to Perforation (width direction)	F	0.138 ± 0.002	3.5 ± 0.05
Cover Tape	Width	C	0.213 ± 0.004	5.4 ± 0.10
Carrier Tape	Width	W	0.315 + 0.012/-0.004	8.0 + 0.3/-0.10

PDFN-8, 2 mm (MO-229, VCCD-3)

Tape Dimensions	Description	Symbol	Size (inches)	Size (mm)
Cavity	Length	A ₀	0.095 ± 0.004	2.42 ± 0.10
	Width	B ₀	0.095 ± 0.004	2.42 ± 0.10
	Depth	K ₀	0.043 ± 0.004	1.1 ± 0.10
	Pitch	P ₁	0.157 ± 0.004	4.0 ± 0.10
	Diameter	D ₁	0.039 ± 0.004	1.0 ± 0.10
Distance Between Centerlines	Cavity to Perforation (length direction)	P ₂	0.079 ± 0.002	2.0 ± 0.05
	Cavity to Perforation (width direction)	F	0.217 ± 0.004	5.5 ± 0.10
Cover Tape	Width	C	0.362 ± 0.004	9.2 ± 0.10
Carrier Tape	Width	W	0.472 ± 0.012	12.0 ± 0.30

Tape and Reel Packaging for Surface Mount Components

Rev. V16

PQFN-12, 3 mm (MO-220, VEED-1), PQFN-16, 3 mm (MO-220, VEED-4, VEED-6)

Tape Dimensions	Description	Symbol	Size (inches)	Size (mm)
Cavity	Length	A ₀	0.130 ± 0.004	3.3 ± 0.10
	Width	B ₀	0.130 ± 0.004	3.3 ± 0.10
	Depth	K ₀	0.043 ± 0.004	1.1 ± 0.10
	Pitch	P ₁	0.315 ± 0.004	8.0 ± 0.10
Distance Between Centerlines	Cavity to Perforation (length direction)	P ₂	0.079 ± 0.004	2.0 ± 0.10
	Cavity to Perforation (width direction)	F	0.217 ± 0.004	5.5 ± 0.10
Cover Tape	Width	C	0.362 ± 0.004	9.2 ± 0.10
Carrier Tape	Width	W	0.472 ± 0.012	12 ± 0.30

PQFN-16, 4 mm (MO-220, VGGC), PQFN-20, 4 mm (MO-220, VGGD-1), PQFN-24, 4 mm (MO-220, VGGD-8)

Tape Dimensions	Description	Symbol	Size (inches)	Size (mm)
Cavity	Length	A ₀	0.171 ± 0.004	4.35 ± 0.10
	Width	B ₀	0.171 ± 0.004	4.35 ± 0.10
	Depth	K ₀	0.043 ± 0.004	1.1 ± 0.10
	Pitch	P ₁	0.315 ± 0.004	8.0 ± 0.10
Distance Between Centerlines	Cavity to Perforation (length direction)	P ₂	0.079 ± 0.004	2.0 ± 0.10
	Cavity to Perforation (width direction)	F	0.217 ± 0.004	5.5 ± 0.10
Cover Tape	Width	C	0.362 ± 0.004	9.2 ± 0.10
Carrier Tape	Width	W	0.472 ± 0.012	12 ± 0.30

PQFN-20, 5 mm (MO-220, VHHC), PQFN-28, 5 mm (MO-220, VHHD-1), PQFN-32, 5 mm (MO-220, VHHD-4, VHHD-5)

Tape Dimensions	Description	Symbol	Size (inches)	Size (mm)
Cavity	Length	A ₀	0.207 ± 0.004	5.25 ± 0.10
	Width	B ₀	0.207 ± 0.004	5.25 ± 0.10
	Depth	K ₀	0.043 ± 0.004	1.1 ± 0.10
	Pitch	P ₁	0.315 ± 0.004	8.0 ± 0.10
Distance Between Centerlines	Cavity to Perforation (length direction)	P ₂	0.079 ± 0.004	2.0 ± 0.10
	Cavity to Perforation (width direction)	F	0.217 ± 0.004	5.5 ± 0.10
Cover Tape	Width	C	0.362 ± 0.004	9.2 ± 0.10
Carrier Tape	Width	W	0.472 ± 0.012	12 ± 0.30

Tape and Reel Packaging for Surface Mount Components

Rev. V16

PQFN-32, 6x4 mm

Tape Dimensions	Description	Symbol	Size (inches)	Size (mm)
Cavity	Length	A ₀	0.165 ± 0.004	4.2 ± 0.10
	Width	B ₀	0.244 ± 0.004	6.2 ± 0.10
	Depth	K ₀	0.047 ± 0.004	1.2 ± 0.10
	Pitch	P ₁	0.315 ± 0.004	8.0 ± 0.10
Carrier Tape	Width	W	0.472 ± 0.012	12 ± 0.30

PQFN-32, 6x5 mm

Tape Dimensions	Description	Symbol	Size (inches)	Size (mm)
Cavity	Length	A ₀	0.209 ± 0.004	5.3 ± 0.10
	Width	B ₀	0.248 ± 0.004	6.3 ± 0.10
	Depth	K ₀	0.047 ± 0.004	1.2 ± 0.10
	Pitch	P ₁	0.315 ± 0.004	8.0 ± 0.10
Carrier Tape	Width	W	0.630 ± 0.012	16 ± 0.30

PQFN-36, 7x4 mm

Tape Dimensions	Description	Symbol	Size (inches)	Size (mm)
Cavity	Length	A ₀	0.165 ± 0.004	4.2 ± 0.10
	Width	B ₀	0.283 ± 0.004	7.2 ± 0.10
	Depth	K ₀	0.047 ± 0.004	1.2 ± 0.10
	Pitch	P ₁	0.315 ± 0.004	8.0 ± 0.10
Carrier Tape	Width	W	0.472 ± 0.012	12 ± 0.30

PQFN-37, 7x6 mm

Tape Dimensions	Description	Symbol	Size (inches)	Size (mm)
Cavity	Length	A ₀	0.252 ± 0.004	6.4 ± 0.10
	Width	B ₀	0.291 ± 0.004	7.4 ± 0.10
	Depth	K ₀	0.047 ± 0.004	1.2 ± 0.10
	Pitch	P ₁	0.472 ± 0.004	12.0 ± 0.10
Carrier Tape	Width	W	0.630 ± 0.012	16 ± 0.30

Tape and Reel Packaging for Surface Mount Components

Rev. V16

QSOP-16, QSOP-16EP

Tape Dimensions	Description	Symbol	Size (inches)	Size (mm)
Cavity	Length	A ₀	0.268 ± 0.004	6.8 ± 0.10
	Width	B ₀	0.213 ± 0.004	5.4 ± 0.10
	Depth	K ₀	0.063 ± 0.004	1.6 ± 0.10
	Pitch	P ₁	0.315 ± 0.004	8.0 ± 0.10
Distance Between Centerlines	Cavity to Perforation (length direction)	P ₂	0.079 ± 0.004	2.0 ± 0.10
	Cavity to Perforation (width direction)	F	0.295 ± 0.004	7.5 ± 0.10
Cover Tape	Width	C	0.524 ± 0.004	13.3 ± 0.10
Carrier Tape	Width	W	0.630 ± 0.012	16 ± 0.30

QSOP-24

Tape Dimensions	Description	Symbol	Size (inches)	Size (mm)
Cavity	Length	A ₀	0.256 ± 0.004	6.5 ± 0.10
	Width	B ₀	0.354 ± 0.004	9.0 ± 0.10
	Depth	K ₀	0.083 ± 0.004	2.1 ± 0.10
	Pitch	P ₁	0.315 ± 0.004	8.0 ± 0.10
Distance Between Centerlines	Cavity to Perforation (length direction)	P ₂	0.079 ± 0.004	2.0 ± 0.10
	Cavity to Perforation (width direction)	F	0.295 ± 0.004	7.5 ± 0.10
Cover Tape	Width	C	0.524 ± 0.004	13.3 ± 0.10
Carrier Tape	Width	W	0.630 ± 0.012	16 ± 0.30

QSOP-28

Tape Dimensions	Description	Symbol	Size (inches)	Size (mm)
Cavity	Length	A ₀	0.256 ± 0.004	6.5 ± 0.10
	Width	B ₀	0.406 ± 0.004	10.3 ± 0.10
	Depth	K ₀	0.083 ± 0.004	2.1 ± 0.10
	Pitch	P ₁	0.315 ± 0.004	8.0 ± 0.10
Distance Between Centerlines	Cavity to Perforation (length direction)	P ₂	0.079 ± 0.004	2.0 ± 0.10
	Cavity to Perforation (width direction)	F	0.295 ± 0.004	7.5 ± 0.10
Cover Tape	Width	C	0.524 ± 0.004	13.3 ± 0.10
Carrier Tape	Width	W	0.630 ± 0.012	16 ± 0.30

R-1, R-4, R-5, R-15

Tape Dimensions	Description	Symbol	Size (inches)	Size (mm)
Cavity	Length	A ₀	0.492 ± 0.004	12.50 ± 0.10
	Width	B ₀	0.508 ± 0.004	12.90 ± 0.10
	Depth	K ₀	0.244 ± 0.004	6.10 ± 0.10
	Pitch	P ₁	0.630 ± 0.004	16.0 ± 0.10
Carrier Tape	Width	W	0.945 ± 0.012	24.0 ± 0.30

Tape and Reel Packaging for Surface Mount Components

Rev. V16

SC-70, SOT-323 (3-lead), SOT-353 (5-lead), and SOT-363 (6-lead)

Tape Dimensions	Description	Symbol	Size (inches)	Size (mm)
Cavity	Length	A ₀	0.089 ± 0.004	2.25 ± 0.10
	Width	B ₀	0.094 ± 0.004	2.40 ± 0.10
	Depth	K ₀	0.047 ± 0.004	1.20 ± 0.10
	Pitch	P ₁	0.157 ± 0.004	4.00 ± 0.10
Distance Between Centerlines	Cavity to Perforation (length direction)	P ₂	0.079 ± 0.004	2.00 ± 0.10
	Cavity to Perforation (width direction)	F	0.138 ± 0.004	3.50 ± 0.10
Cover Tape	Width	C	0.213 ± 0.004	5.40 ± 0.10
Carrier Tape	Width	W	0.315 ± 0.012	8.00 ± 0.30

SC-79

Tape Dimensions	Description	Symbol	Size (inches)	Size (mm)
Cavity	Length	A ₀	0.035 ± 0.002	0.90 ± 0.05
	Width	B ₀	0.076 ± 0.002	1.94 ± 0.05
	Depth	K ₀	0.029 ± 0.002	0.73 ± 0.05
	Pitch	P ₁	0.157 ± 0.002	4.00 ± 0.05
Distance Between Centerlines	Cavity to Perforation (length direction)	P ₂	0.079 ± 0.002	2.00 ± 0.05
	Cavity to Perforation (width direction)	F	0.138 ± 0.002	3.50 ± 0.05
Cover Tape	Width	C	0.213 ± 0.004	5.40 ± 0.10
Carrier Tape	Width	W	0.315 +0.012/-0.004	8.00 +0.30/-0.10

SM-1, SM-23, SM-69, SM-87, SM-89, SM-134

Tape Dimensions	Description	Symbol	Size (inches)	Size (mm)
Cavity	Length	A ₀	0.275 ± 0.004	7.00 ± 0.10
	Width	B ₀	0.335 ± 0.004	8.50 ± 0.10
	Depth	K ₀	0.209 ± 0.004	5.30 ± 0.10
	Pitch	P ₁	0.472 ± 0.004	12.0 ± 0.10
Carrier Tape	Width	W	0.630 ± 0.012	16.0 ± 0.30

SM-2, SM-4, SM-74, SM-108

Tape Dimensions	Description	Symbol	Size (inches)	Size (mm)
Cavity	Length	A ₀	0.401 ± 0.004	10.26 ± 0.10
	Width	B ₀	0.530 ± 0.004	13.46 ± 0.10
	Depth	K ₀	0.240 ± 0.004	6.10 ± 0.10
	Pitch	P ₁	0.472 ± 0.004	12.0 ± 0.10
Carrier Tape	Width	W	0.945 ± 0.012	24.0 ± 0.30

Tape and Reel Packaging for Surface Mount Components

Rev. V16

SM-3

Tape Dimensions	Description	Symbol	Size (inches)	Size (mm)
Cavity	Length	A ₀	0.807 ± 0.004	20.50 ± 0.10
	Width	B ₀	0.807 ± 0.004	20.50 ± 0.10
	Depth	K ₀	0.209 ± 0.004	5.30 ± 0.10
	Pitch	P ₁	0.945 ± 0.004	24.0 ± 0.10
Carrier Tape	Width	W	1.260 ± 0.012	32.00 ± 0.30

SM-7-1

Tape Dimensions	Description	Symbol	Size (inches)	Size (mm)
Cavity	Length	A ₀	0.642 ± 0.004	16.30 ± 0.10
	Width	B ₀	0.843 ± 0.004	21.40 ± 0.10
	Depth	K ₀	0.220 ± 0.004	5.60 ± 0.10
	Pitch	P ₁	0.945 ± 0.004	24.00 ± 0.10
Carrier Tape	Width	W	1.260 ± 0.012	32.00 ± 0.30

SM-20

Tape Dimensions	Description	Symbol	Size (inches)	Size (mm)
Cavity	Length	A ₀	0.319 ± 0.004	8.10 ± 0.10
	Width	B ₀	0.606 ± 0.004	15.40 ± 0.10
	Depth	K ₀	0.280 ± 0.004	7.10 ± 0.10
	Pitch	P ₁	0.472 ± 0.004	12.0 ± 0.10
Carrier Tape	Width	W	0.945 ± 0.012	24.0 ± 0.30

SM-22

Tape Dimensions	Description	Symbol	Size (inches)	Size (mm)
Cavity	Length	A ₀	0.169 ± 0.004	4.30 ± 0.10
	Width	B ₀	0.197 ± 0.004	5.00 ± 0.10
	Depth	K ₀	0.110 ± 0.004	2.80 ± 0.10
	Pitch	P ₁	0.315 ± 0.004	8.00 ± 0.10
Carrier Tape	Width	W	0.472 ± 0.012	12.00 ± 0.30

SM-24

Tape Dimensions	Description	Symbol	Size (inches)	Size (mm)
Cavity	Length	A ₀	0.413 ± 0.004	10.50 ± 0.10
	Width	B ₀	0.323 ± 0.004	8.28 ± 0.10
	Depth	K ₀	0.220 ± 0.004	5.50 ± 0.10
	Pitch	P ₁	0.630 ± 0.004	16.0 ± 0.10
Carrier Tape	Width	W	0.945 ± 0.012	24.0 ± 0.30

Tape and Reel Packaging for Surface Mount Components

Rev. V16

SM-26

Tape Dimensions	Description	Symbol	Size (inches)	Size (mm)
Cavity	Length	A ₀	0.476 ± 0.004	12.10 ± 0.10
	Width	B ₀	0.780 ± 0.004	19.80 ± 0.10
	Depth	K ₀	0.217 ± 0.004	5.50 ± 0.10
	Pitch	P ₁	0.630 ± 0.004	16.0 ± 0.10
Carrier Tape	Width	W	1.260 ± 0.012	32.00 ± 0.30

SM-28

Tape Dimensions	Description	Symbol	Size (inches)	Size (mm)
Cavity	Length	A ₀	0.476 ± 0.004	12.10 ± 0.10
	Width	B ₀	0.831 ± 0.004	21.10 ± 0.10
	Depth	K ₀	0.256 ± 0.004	6.50 ± 0.10
	Pitch	P ₁	0.945 ± 0.004	24.00 ± 0.10
Carrier Tape	Width	W	1.260 ± 0.012	32.00 ± 0.30

SM-41

Tape Dimensions	Description	Symbol	Size (inches)	Size (mm)
Cavity	Length	A ₀	0.272 ± 0.004	6.90 ± 0.10
	Width	B ₀	0.331 ± 0.004	8.40 ± 0.10
	Depth	K ₀	0.291 ± 0.004	7.40 ± 0.10
	Pitch	P ₁	0.472 ± 0.004	12.0 ± 0.10
Carrier Tape	Width	W	0.945 ± 0.012	24.0 ± 0.30

SM-44, SM-68

Tape Dimensions	Description	Symbol	Size (inches)	Size (mm)
Cavity	Length	A ₀	0.295 ± 0.004	7.50 ± 0.10
	Width	B ₀	0.331 ± 0.004	8.40 ± 0.10
	Depth	K ₀	0.217 ± 0.004	5.50 ± 0.10
	Pitch	P ₁	0.472 ± 0.004	12.0 ± 0.10
Carrier Tape	Width	W	0.630 ± 0.012	16.0 ± 0.30

SM-46

Tape Dimensions	Description	Symbol	Size (inches)	Size (mm)
Cavity	Length	A ₀	0.823 ± 0.004	20.90 ± 0.10
	Width	B ₀	0.449 ± 0.004	11.40 ± 0.10
	Depth	K ₀	0.268 ± 0.004	6.80 ± 0.10
	Pitch	P ₁	0.945 ± 0.004	24.00 ± 0.10
Carrier Tape	Width	W	1.260 ± 0.012	32.00 ± 0.30

SM-52

Tape Dimensions	Description	Symbol	Size (inches)	Size (mm)
Cavity	Length	A ₀	0.220 ± 0.004	5.60 ± 0.10
	Width	B ₀	0.220 ± 0.004	5.60 ± 0.10
	Depth	K ₀	0.118 ± 0.004	3.00 ± 0.10
	Pitch	P ₁	0.315 ± 0.004	8.00 ± 0.10
Carrier Tape	Width	W	0.472 ± 0.012	12.00 ± 0.30

Tape and Reel Packaging for Surface Mount Components

Rev. V16

SM-55

Tape Dimensions	Description	Symbol	Size (inches)	Size (mm)
Cavity	Length	A ₀	0.268 ± 0.004	6.80 ± 0.10
	Width	B ₀	0.299 ± 0.004	7.60 ± 0.10
	Depth	K ₀	0.138 ± 0.004	3.50 ± 0.10
	Pitch	P ₁	0.472 ± 0.004	12.00 ± 0.10
Carrier Tape	Width	W	0.630 ± 0.012	16.00 ± 0.30

SM-106

Tape Dimensions	Description	Symbol	Size (inches)	Size (mm)
Cavity	Length	A ₀	0.421 ± 0.004	10.70 ± 0.10
	Width	B ₀	0.818 ± 0.004	20.80 ± 0.10
	Depth	K ₀	0.236 ± 0.004	6.00 ± 0.10
	Pitch	P ₁	0.944 ± 0.004	24.00 ± 0.10
Carrier Tape	Width	W	1.260 ± 0.012	32.00 ± 0.30

SOD-323

Tape Dimensions	Description	Symbol	Size (inches)	Size (mm)
Cavity	Length	A ₀	0.057 ± 0.004	1.46 ± 0.10
	Width	B ₀	0.114 ± 0.002	2.90 ± 0.05
	Depth	K ₀	0.049 ± 0.002	1.25 ± 0.05
	Pitch	P ₁	0.157 ± 0.004	4.0 ± 0.10
Distance Between Centerlines	Cavity to Perforation (length direction)	P ₂	0.079 ± 0.002	2.0 ± 0.05
	Cavity to Perforation (width direction)	F	0.138 ± 0.002	3.5 ± 0.05
Cover Tape	Width	C	0.213 ± 0.004	5.40 ± 0.10
Carrier Tape	Width	W	0.315 +0.012/-0.004	8.0 +0.30/-0.10

SOT-25, SOT-26

Tape Dimensions	Description	Symbol	Size (inches)	Size (mm)
Cavity	Length	A ₀	0.126 ± 0.004	3.2 ± 0.10
	Width	B ₀	0.126 ± 0.004	3.2 ± 0.10
	Depth	K ₀	0.055 ± 0.004	1.4 ± 0.10
	Pitch	P ₁	0.157 ± 0.004	4.0 ± 0.10
Distance Between Centerlines	Cavity to Perforation (length direction)	P ₂	0.079 ± 0.004	2.0 ± 0.10
	Cavity to Perforation (width direction)	F	0.138 ± 0.004	3.5 ± 0.10
Cover Tape	Width	C	0.213 ± 0.004	5.4 ± 0.10
Carrier Tape	Width	W	0.315 ± 0.012	8.0 ± 0.30

Tape and Reel Packaging for Surface Mount Components

Rev. V16

SOIC-8 (SO-8)

Tape Dimensions	Description	Symbol	Size (inches)	Size (mm)
Cavity	Length	A ₀	0.252 ± 0.004	6.4 ± 0.10
	Width	B ₀	0.205 ± 0.004	5.2 ± 0.10
	Depth	K ₀	0.083 ± 0.004	2.1 ± 0.10
	Pitch	P ₁	0.315 ± 0.004	8.0 ± 0.10
Distance Between Centerlines	Cavity to Perforation (length direction)	P ₂	0.079 ± 0.004	2.0 ± 0.10
	Cavity to Perforation (width direction)	F	0.217 ± 0.004	5.5 ± 0.10
Cover Tape	Width	C	0.366 ± 0.004	9.2 ± 0.10
Carrier Tape	Width	W	0.472 ± 0.012	12.0 ± 0.30

SOIC-14 (SO-14), SSOP-24

Tape Dimensions	Description	Symbol	Size (inches)	Size (mm)
Cavity	Length	A ₀	0.256 ± 0.004	6.5 ± 0.10
	Width	B ₀	0.354 ± 0.004	9.0 ± 0.10
	Depth	K ₀	0.083 ± 0.004	2.1 ± 0.10
	Pitch	P ₁	0.315 ± 0.004	8.0 ± 0.10
Distance Between Centerlines	Cavity to Perforation (length direction)	P ₂	0.079 ± 0.004	2.0 ± 0.10
	Cavity to Perforation (width direction)	F	0.295 ± 0.004	7.5 ± 0.10
Cover Tape	Width	C	0.524 ± 0.004	13.3 ± 0.10
Carrier Tape	Width	W	0.630 ± 0.012	16.0 ± 0.30

SOIC-16 (SO-16), SSOP-28

Tape Dimensions	Description	Symbol	Size (inches)	Size (mm)
Cavity	Length	A ₀	0.256 ± 0.004	6.5 ± 0.10
	Width	B ₀	0.406 ± 0.004	10.3 ± 0.10
	Depth	K ₀	0.083 ± 0.004	2.1 ± 0.10
	Pitch	P ₁	0.315 ± 0.004	8.0 ± 0.10
Distance Between Centerlines	Cavity to Perforation (length direction)	P ₂	0.079 ± 0.004	2.0 ± 0.10
	Cavity to Perforation (width direction)	F	0.295 ± 0.004	7.5 ± 0.10
Cover Tape	Width	C	0.524 ± 0.004	13.3 ± 0.10
Carrier Tape	Width	W	0.630 ± 0.012	16.0 ± 0.30

SOIC-16 Wide Body (SOW-16)

Tape Dimensions	Description	Symbol	Size (inches)	Size (mm)
Cavity	Length	A ₀	0.429 ± 0.004	10.9 ± 0.10
	Width	B ₀	0.421 ± 0.004	10.7 ± 0.10
	Depth	K ₀	0.118 ± 0.004	3.0 ± 0.10
	Pitch	P ₁	0.472 ± 0.004	12.0 ± 0.10
Distance Between Centerlines	Cavity to Perforation (length direction)	P ₂	0.079 ± 0.004	2.0 ± 0.10
	Cavity to Perforation (width direction)	F	0.295 ± 0.004	7.5 ± 0.10
Cover Tape	Width	C	0.524 ± 0.004	13.3 ± 0.10
Carrier Tape	Width	W	0.630 ± 0.012	16.0 ± 0.30

Tape and Reel Packaging for Surface Mount Components

Rev. V16

SOIC-24 (SO-24)

Tape Dimensions	Description	Symbol	Size (inches)	Size (mm)
Cavity	Length	A ₀	0.421 ± 0.008	10.7 ± 0.2
	Width	B ₀	0.622 ± 0.008	15.8 ± 0.2
	Depth	K ₀	0.118 ± 0.004	3.0 ± 0.10
	Pitch	P ₁	0.472 ± 0.004	12.0 ± 0.10
Distance Between Centerlines	Cavity to Perforation (length direction)	P ₂	0.079 ± 0.004	2.0 ± 0.10
	Cavity to Perforation (width direction)	F	0.453 ± 0.004	11.5 ± 0.10
Cover Tape	Width	C	0.79 Nom.	20.0 Nom.
Carrier Tape	Width	W	0.945 ± 0.012	24.0 ± 0.30

SOT-23

Tape Dimensions	Description	Symbol	Size (inches)	Size (mm)
Cavity	Length	A ₀	0.123 ± 0.005	3.125 ± 0.125
	Width	B ₀	0.112 ± 0.006	2.835 ± 0.165
	Depth	K ₀	0.048 ± 0.004	1.23 ± 0.11
	Pitch	P ₁	0.157 ± 0.004	4.0 ± 0.10
Distance Between Centerlines	Cavity to Perforation (length direction)	P ₂	0.079 ± 0.004	2.0 ± 0.10
	Cavity to Perforation (width direction)	F	0.138 ± 0.004	3.5 ± 0.10
Cover Tape	Width	C	0.212 ± 0.004	5.4 ± 0.10
Carrier Tape	Width	W	0.315 ± 0.012	8.0 ± 0.30

SOT-143

Tape Dimensions	Description	Symbol	Size (inches)	Size (mm)
Cavity	Length	A ₀	0.122 ± 0.004	3.1 ± 0.10
	Width	B ₀	0.106 ± 0.004	2.69 ± 0.10
	Depth	K ₀	0.051 ± 0.004	1.30 ± 0.10
	Pitch	P ₁	0.157 ± 0.004	4.0 ± 0.10
Distance Between Centerlines	Cavity to Perforation (length direction)	P ₂	0.079 ± 0.004	2.0 ± 0.10
	Cavity to Perforation (width direction)	F	0.138 ± 0.004	3.5 ± 0.10
Cover Tape	Width	C	0.212 ± 0.004	5.4 ± 0.10
Carrier Tape	Width	W	0.315 ± 0.012	8.0 ± 0.30

SOT-89

Tape Dimensions	Description	Symbol	Size (inches)	Size (mm)
Cavity	Length	A ₀	0.181 ± 0.004	4.6 ± 0.10
	Width	B ₀	0.188 ± 0.004	4.78 ± 0.10
	Depth	K ₀	0.075 ± 0.004	1.9 ± 0.10
	Pitch	P ₁	0.315 ± 0.004	8.0 ± 0.10
Distance Between Centerlines	Cavity to Perforation (length direction)	P ₂	0.079 ± 0.004	2.0 ± 0.10
	Cavity to Perforation (width direction)	F	0.217 ± 0.020	5.5 ± 0.5
Cover Tape	Width	C	0.366 ± 0.004	9.3 ± 0.10
Carrier Tape	Width	W	0.472 ± 0.008	12.0 ± 0.20

Tape and Reel Packaging for Surface Mount Components

Rev. V16

SSOP-8

Tape Dimensions	Description	Symbol	Size (inches)	Size (mm)
Cavity	Length	A ₀	0.134 ± 0.004	3.4 ± 0.10
	Width	B ₀	0.327 ± 0.004	8.3 ± 0.10
	Depth	K ₀	0.100 ± 0.004	2.54 ± 0.10
	Pitch	P ₁	0.315 Nom.	8.0 Nom.
Distance Between Centerlines	Cavity to Perforation (length direction)	P ₂	0.079 ± 0.004	2.0 ± 0.10
	Cavity to Perforation (width direction)	F	0.295 ± 0.004	7.5 ± 0.10
Cover Tape	Width	C	0.524 ± 0.004	13.3 ± 0.10
Carrier Tape	Width	W	0.630 ± 0.012	16.0 ± 0.30

SSOP-20

Tape Dimensions	Description	Symbol	Size (inches)	Size (mm)
Cavity	Length	A ₀	0.322 ± 0.004	8.2 ± 0.10
	Width	B ₀	0.295 ± 0.004	7.5 ± 0.10
	Depth	K ₀	0.099 ± 0.004	2.5 ± 0.10
	Pitch	P ₁	0.472 ± 0.004	12.0 ± 0.10
Distance Between Centerlines	Cavity to Perforation (length direction)	P ₂	0.079 ± 0.004	2.0 ± 0.10
	Cavity to Perforation (width direction)	F	0.295 ± 0.004	7.5 ± 0.10
Cover Tape	Width	C	0.524 ± 0.004	13.3 ± 0.10
Carrier Tape	Width	W	0.630 ± 0.012	16.0 ± 0.30

STDFN-8, 2 mm, STQFN-12, 2 mm

Tape Dimensions	Description	Symbol	Size (inches)	Size (mm)
Cavity	Length	A ₀	0.090 ± 0.004	2.3 ± 0.10
	Width	B ₀	0.090 ± 0.004	2.3 ± 0.10
	Depth	K ₀	0.030 ± 0.004	0.75 ± 0.10
	Pitch	P ₁	0.157 ± 0.004	4.0 ± 0.10
	Diameter	D ₁	0.039 ± 0.010	1.0 ± 0.25
Distance Between Centerlines	Cavity to Perforation (length direction)	P ₂	0.079 ± 0.002	2.0 ± 0.05
	Cavity to Perforation (width direction)	F	0.138 ± 0.002	3.5 ± 0.05
Cover Tape	Width	C	0.216 ± 0.004	5.5 ± 0.10
Carrier Tape	Width	W	0.315 ± 0.012	8.0 ± 0.30

Tape and Reel Packaging for Surface Mount Components

Rev. V16

STQFN-14, 2 x 2.5 mm

Tape Dimensions	Description	Symbol	Size (inches)	Size (mm)
Cavity	Length	A ₀	0.087 ± 0.004	2.2 ± 0.10
	Width	B ₀	0.106 ± 0.004	2.7 ± 0.10
	Depth	K ₀	0.028 ± 0.002	0.7 ± 0.05
	Pitch	P ₁	0.157 ± 0.004	4.0 ± 0.10
	Diameter	D ₁	0.028 ± 0.004	0.7 ± 0.10
Distance Between Centerlines	Cavity to Perforation (length direction)	P ₂	0.079 ± 0.002	2.0 ± 0.05
	Cavity to Perforation (width direction)	F	0.138 ± 0.004	3.5 ± 0.10
Cover Tape	Width	C	0.217 ± 0.004	5.5 ± 0.10
Carrier Tape	Width	W	0.315 ± 0.012	8.0 ± 0.30

TSSOP-16, TSSOP-16EP

Tape Dimensions	Description	Symbol	Size (inches)	Size (mm)
Cavity	Length	A ₀	0.274 ± 0.004	6.95 ± 0.10
	Width	B ₀	0.220 ± 0.004	5.6 ± 0.10
	Depth	K ₀	0.063 ± 0.004	1.6 ± 0.10
	Pitch	P ₁	0.315 ± 0.004	8.0 ± 0.10
Distance Between Centerlines	Cavity to Perforation (length direction)	P ₂	0.079 ± 0.004	2.0 ± 0.10
	Cavity to Perforation (width direction)	F	0.295 ± 0.004	7.5 ± 0.10
Cover Tape	Width	C	0.524 ± 0.004	13.3 ± 0.10
Carrier Tape	Width	W	0.630 ± 0.012	16 ± 0.30

X1DFN-6, 1 mm

Tape Dimensions	Description	Symbol	Size (inches)	Size (mm)
Cavity	Length	A ₀	0.047 + 0.00/-0.002	1.2 + 0.00/-0.05
	Width	B ₀	0.047 + 0.00/-0.002	1.2 + 0.00/-0.05
	Depth	K ₀	0.022 ± 0.002	0.55 ± 0.05
	Pitch	P ₁	0.157 ± 0.004	4.0 ± 0.10
Distance Between Centerlines	Cavity to Perforation (length direction)	P ₂	0.079 ± 0.002	2.0 ± 0.05
	Cavity to Perforation (width direction)	F	0.138 ± 0.004	3.5 ± 0.10
Cover Tape	Width	C	0.217 ± 0.004	5.5 ± 0.10
Carrier Tape	Width	W	0.315 ± 0.012	8.0 ± 0.30

Tape and Reel Packaging for Surface Mount Components

Rev. V16

Component Orientation for Tape and Reel

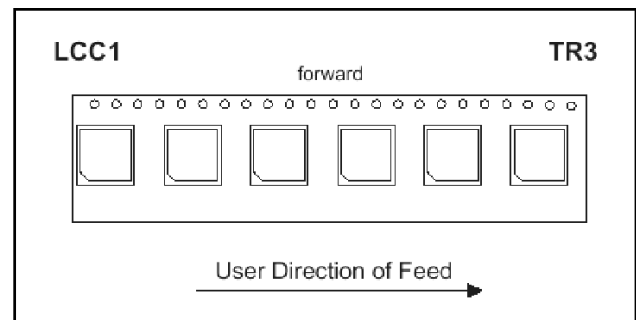
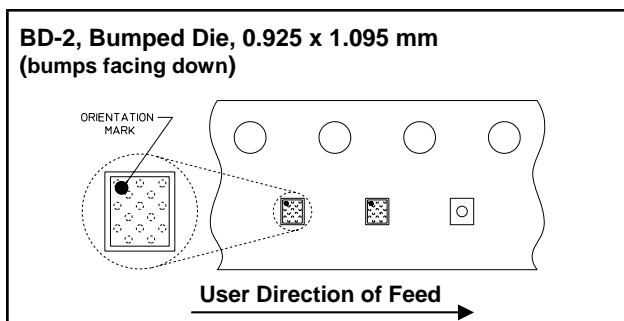
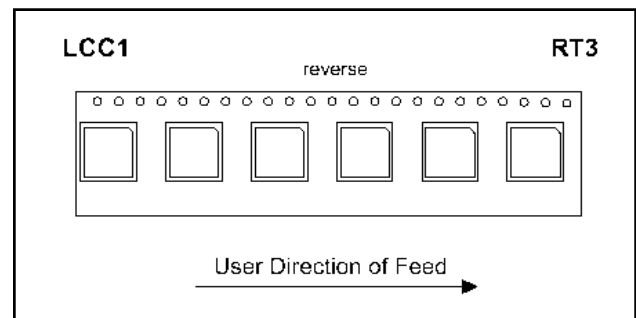
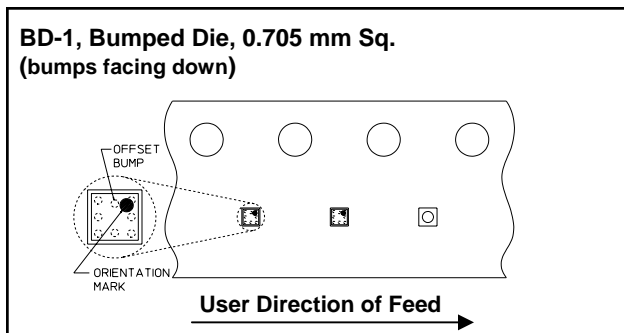
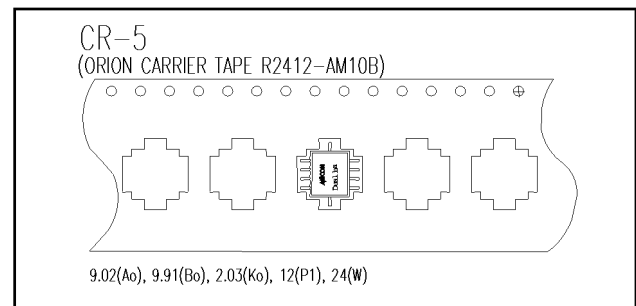
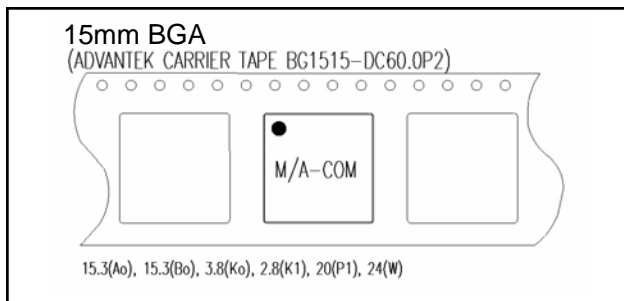
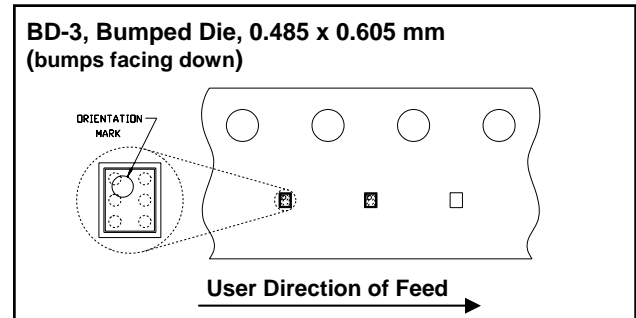
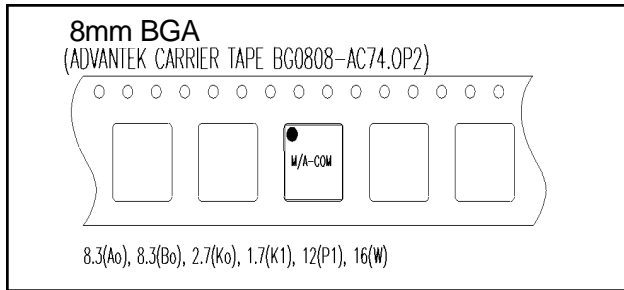

Component Orientation for Tape and Reel

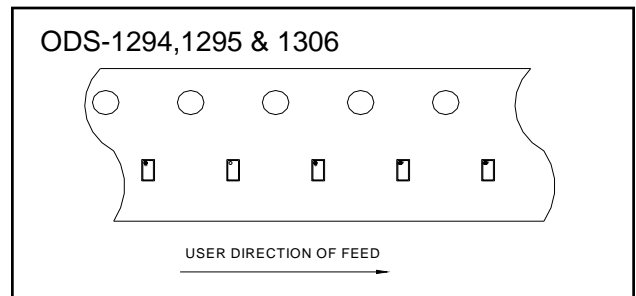
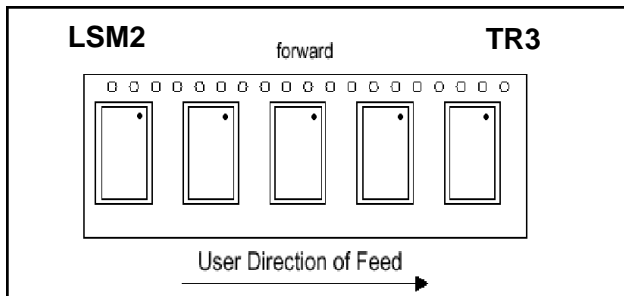
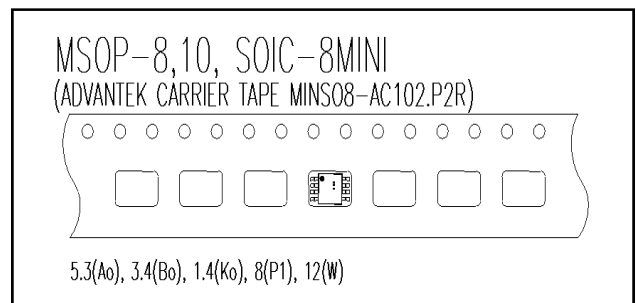
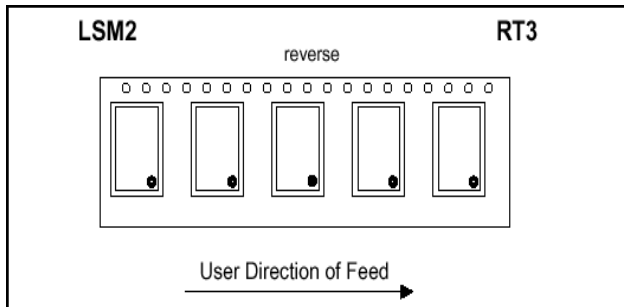
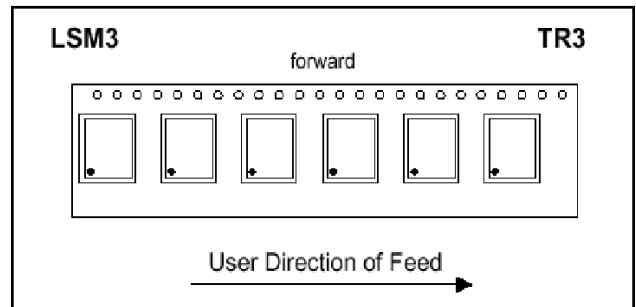
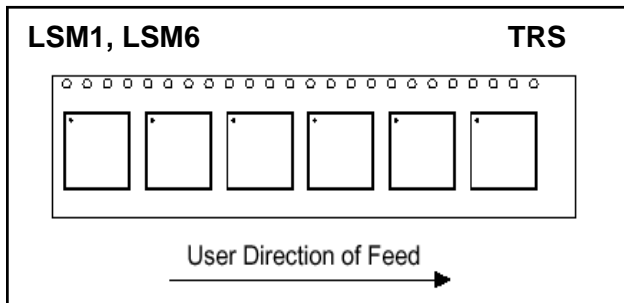
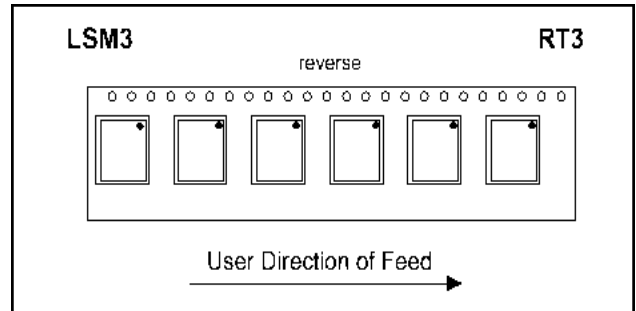
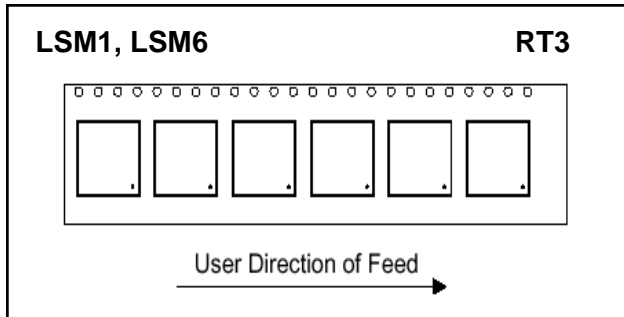

Component Orientation for Tape and Reel

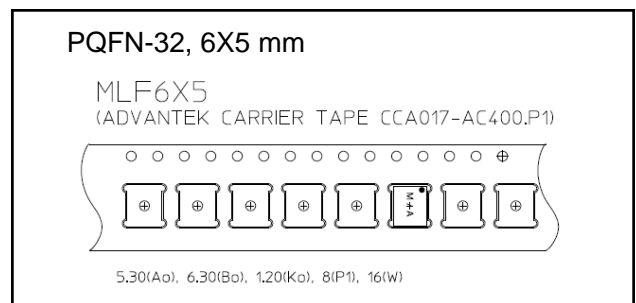
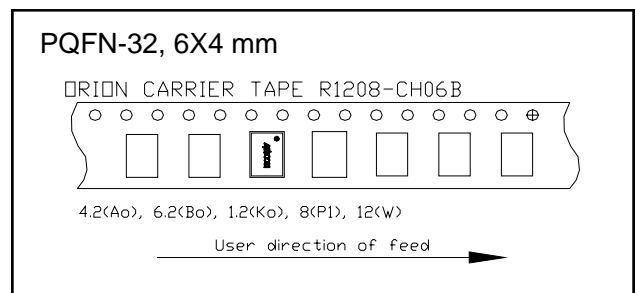
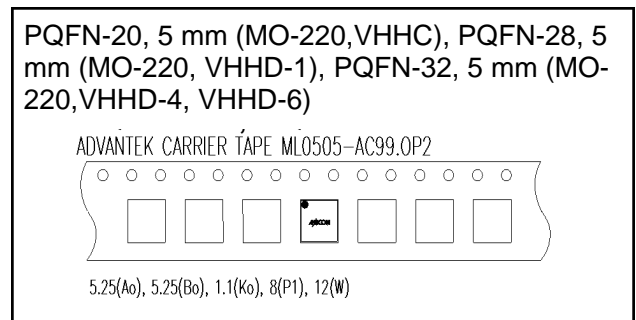
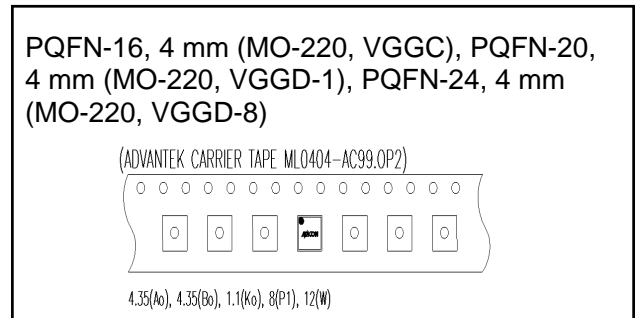
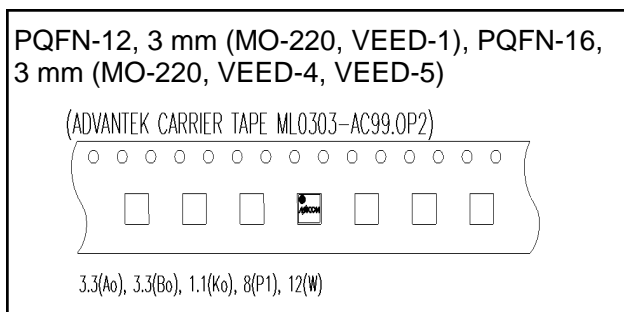
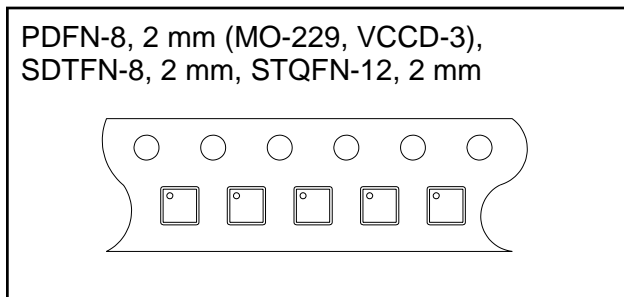
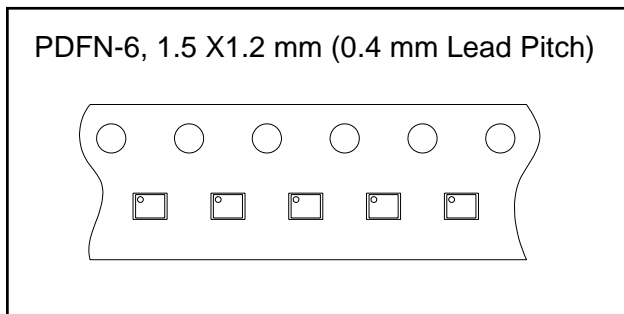
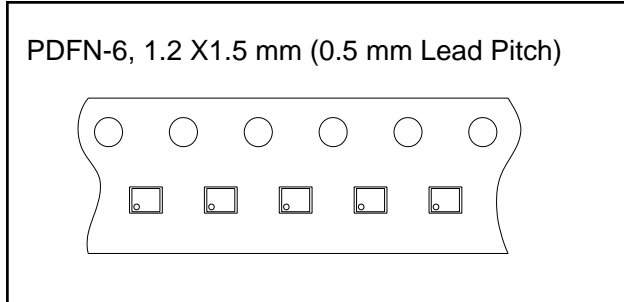

Component Orientation for Tape and Reel

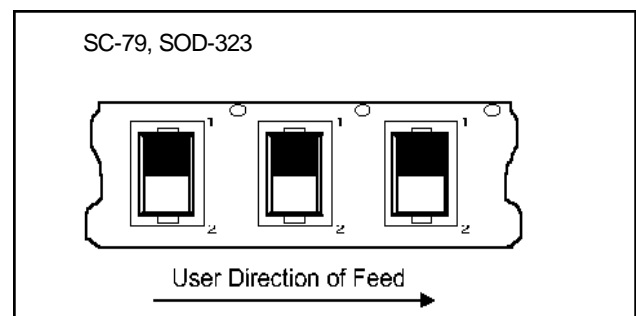
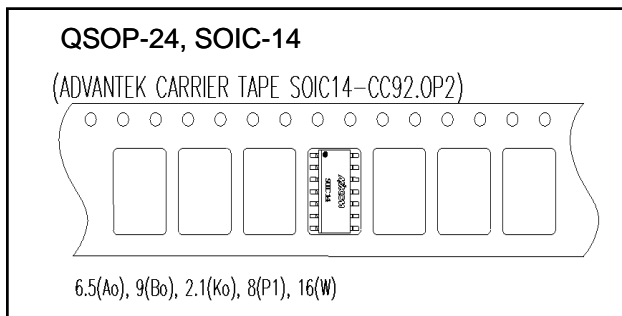
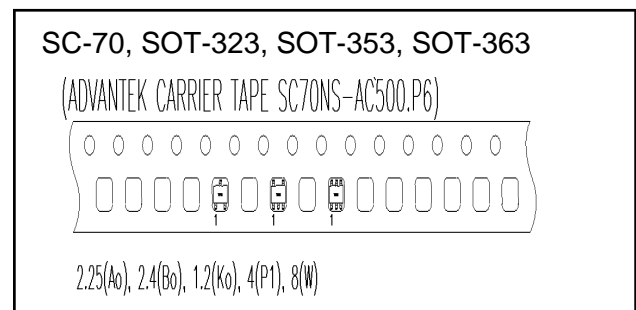
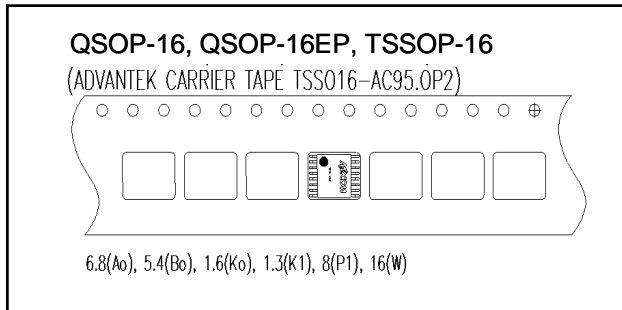
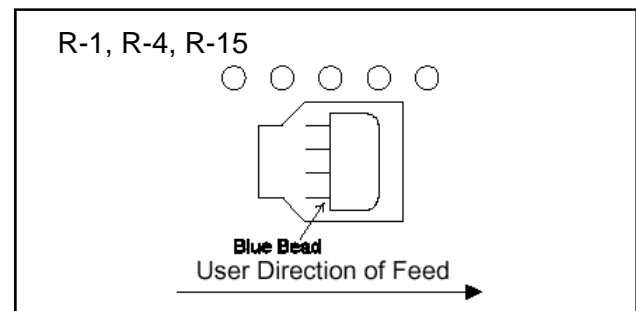
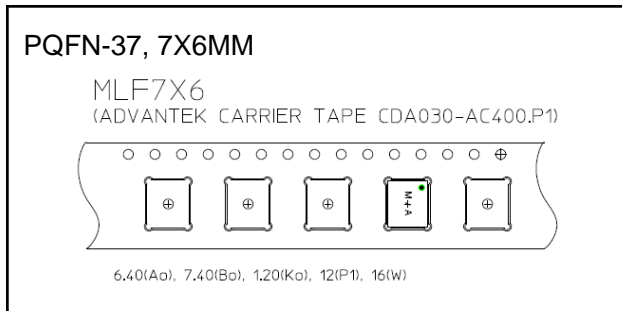
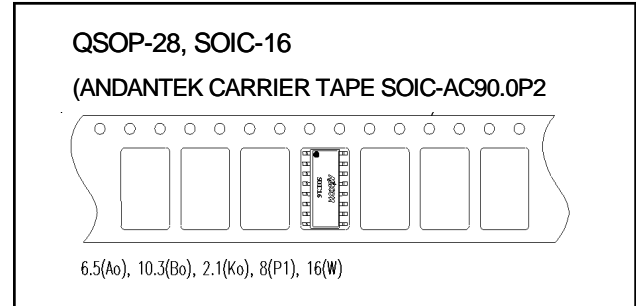
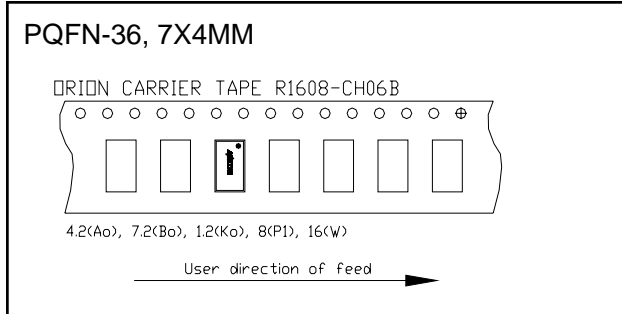

Component Orientation for Tape and Reel

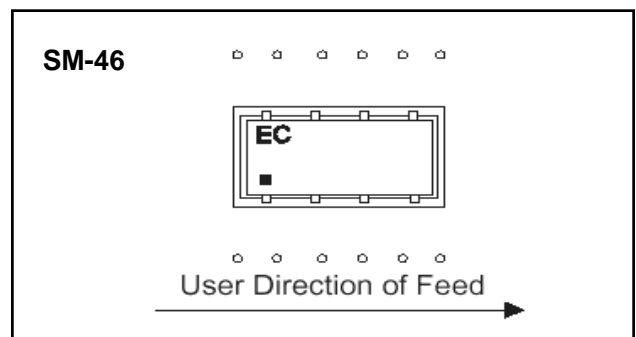
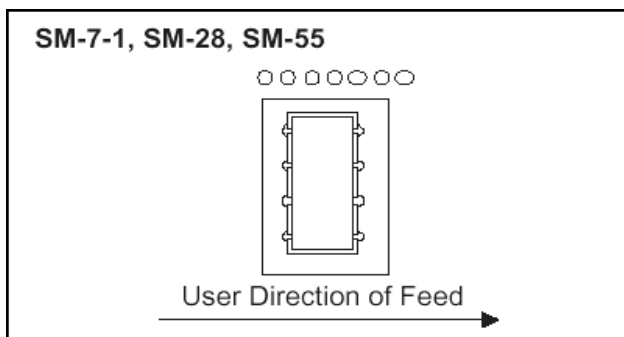
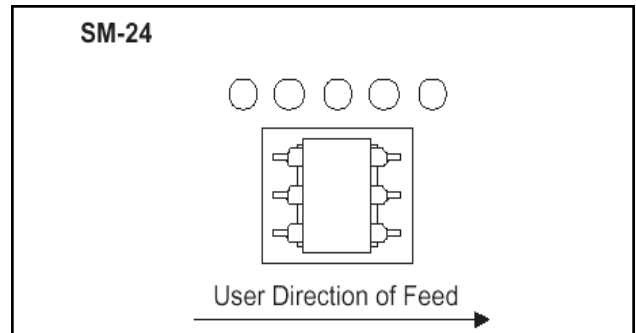
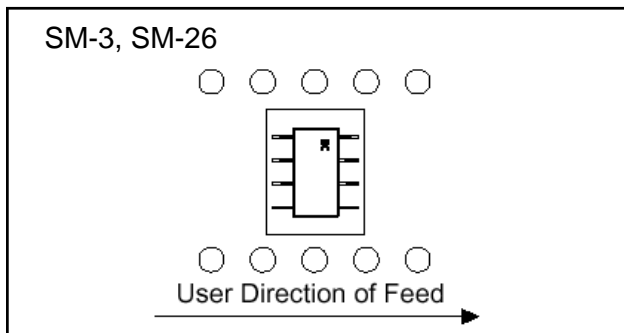
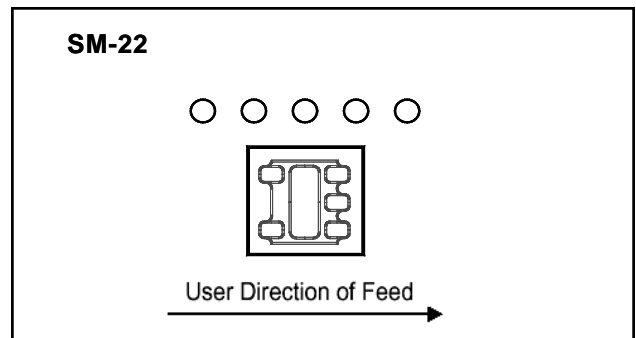
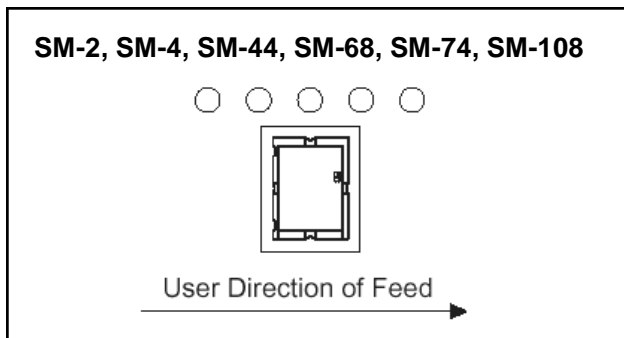
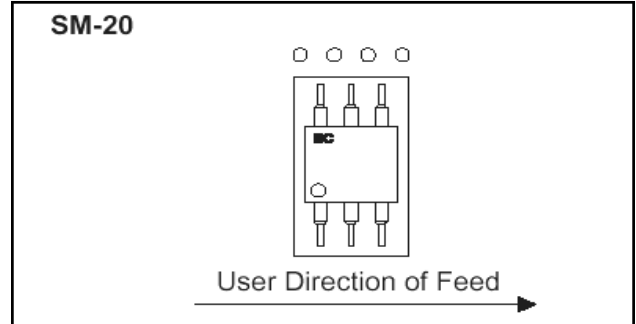
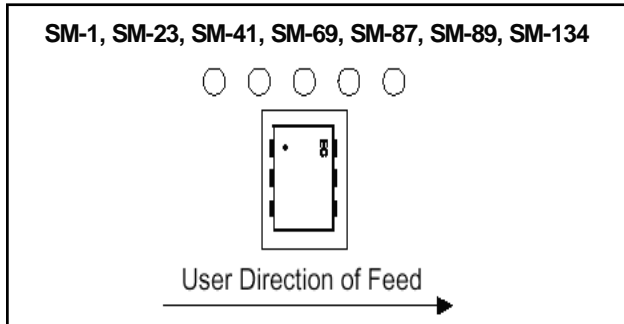

Component Orientation for Tape and Reel

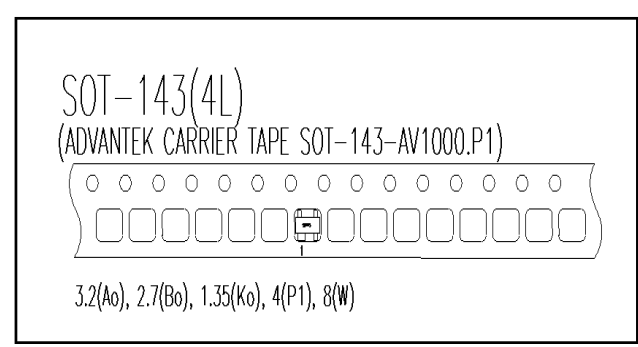
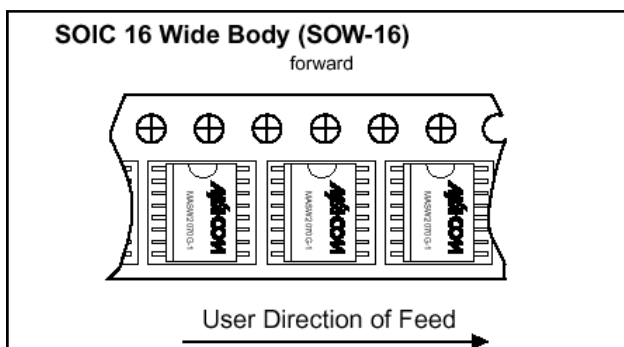
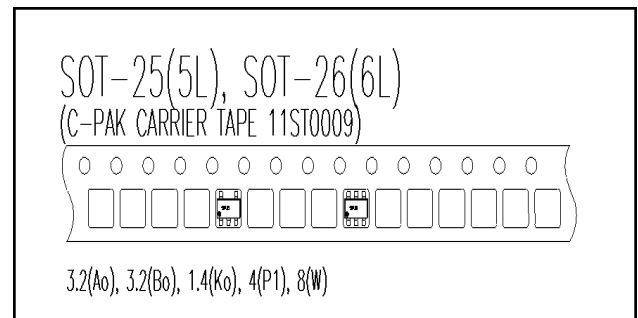
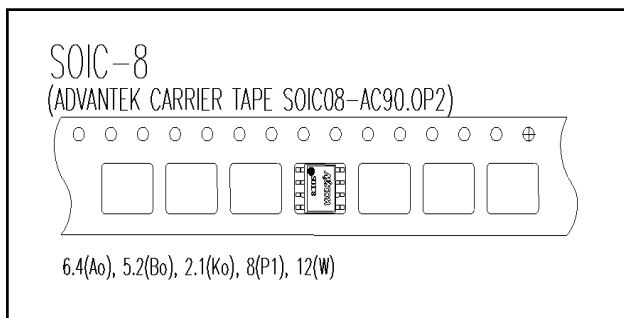
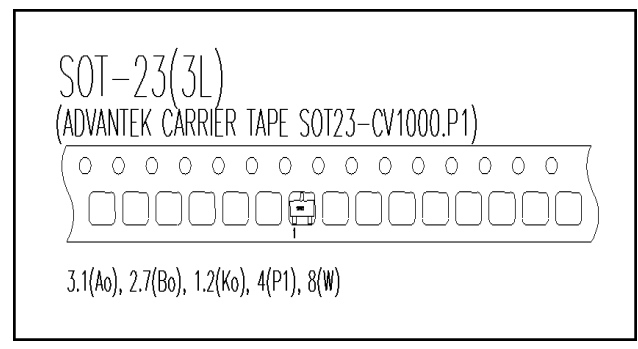
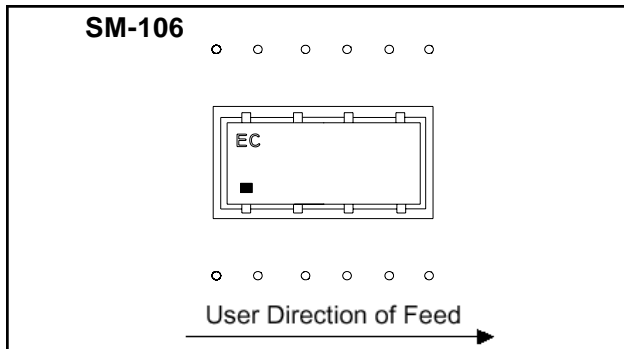
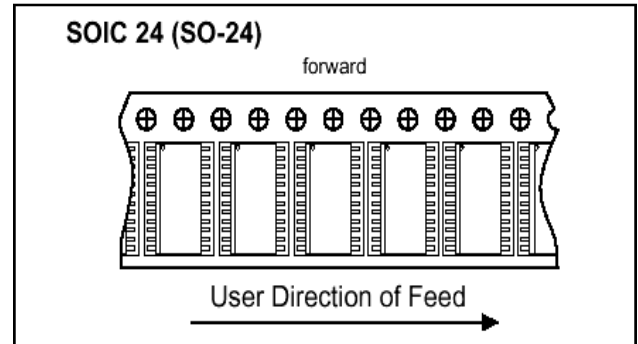
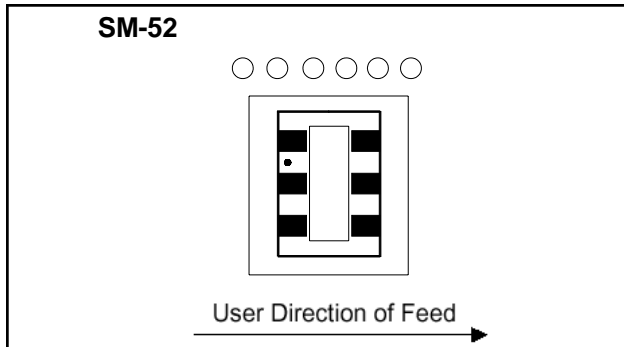

Component Orientation for Tape and Reel

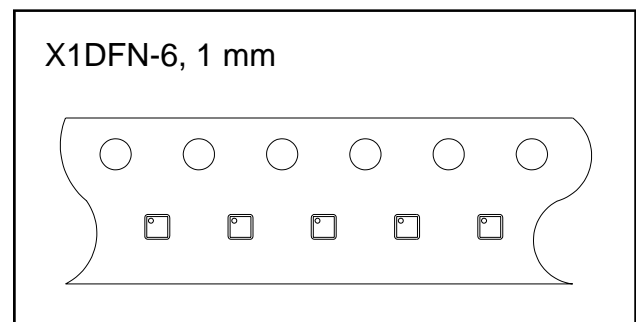
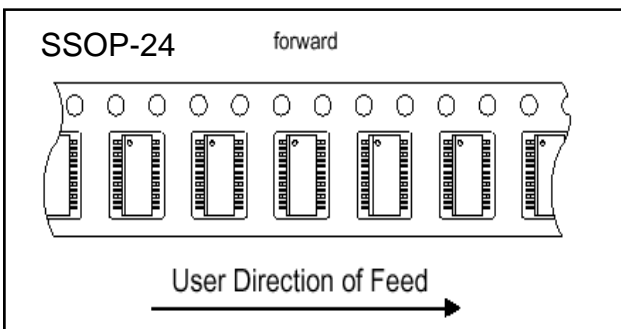
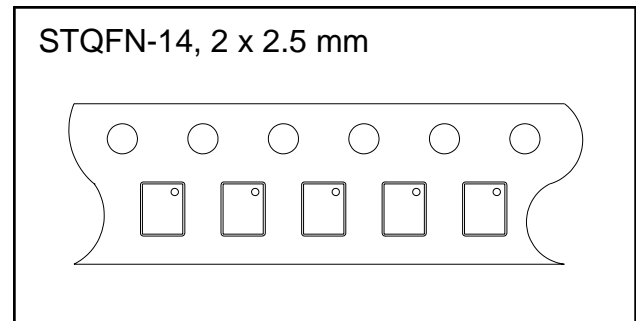
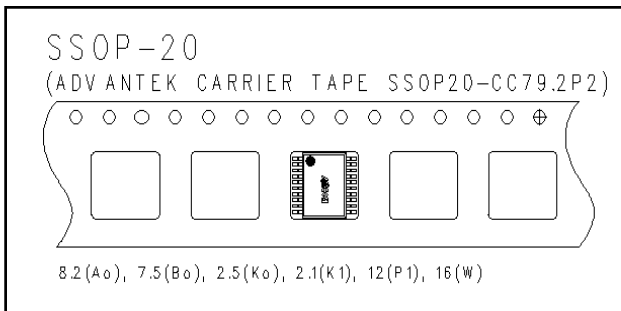
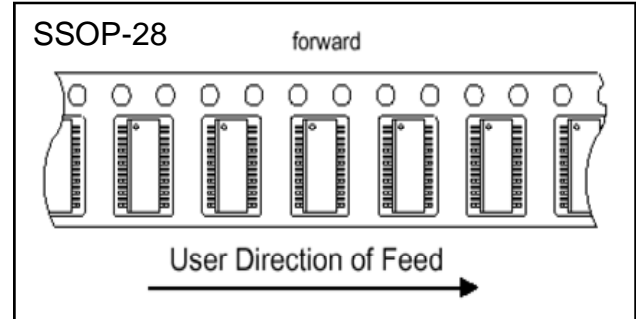
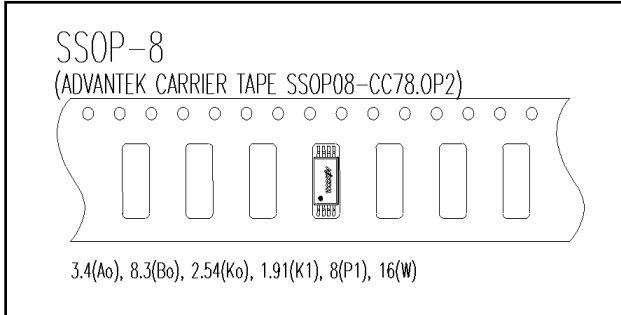

Tape and Reel Packaging for Surface Mount Components

Rev. V16

Reel Information^{1,2}

Package Type	Max. Devices per Reel	Reel Diameter (inches)
8-mm BGA, 15-mm BGA	1,000	13
BD-1, BD-2, BD-3	3000	7
CR-5	2,500	13
LSM1, LSM2, LSM3, LCC1	500	13
MSOP8, MSOP-8EP, MSOP-10	1,000	7
	3,000	13
ODS-4, ODS-54, ODS-139, ODS-146, ODS-401	3,000	10
ODS-120	2,000	7
ODS-186	750	7
ODS-402	2,000	10
ODS-1056	2,500	7
ODS-1072	5,000	13
ODS-1079	750	7
ODS-1091	500	7
ODS-1295, 1295, 1306	3000	7
PDFN-6, 1.2 x 1.5 mm (0.5 mm pitch), PDFN-6, 1.5 x 1.2 mm (0.4 mm pitch)	3000	7
PDFN-8, 2 mm (MO-229, VCCD-3)	3000	13
STDFN-8, 2 mm, STQFN-12, 2 mm STQFN-14, 2 x 2.5 mm X1DFN-6, 1 mm	3000	7
PQFN-12, 3 mm (MO-220, VEED-1), PQFN-16, 3 mm (MO-220, VEED-4, VEED-6), PQFN-16, 4 mm (MO-220, VGGC), PQFN-20, 4 mm (MO-220, VGGD-1), PQFN-24, 4 mm (MO-220, VGGD-8)	1,000	7
	3,000	13
PQFN-20, 5 mm (MO-220, VHHC), PQFN-28, 5 mm (MO-220, VHHD-1), PQFN-32, 5 mm (MO-220, VHHD-4, VHHD-5)	1,000	7
PQFN-36, 6 x 5 mm	1,000	7
	3,000	13
PQFN-32, 6 x 4 mm, PQFN-36, 7 x 4 mm	1,000	7
PQFN-37, 7 x 6 mm	1,000	7
	3,000	13
QSOP-16, QSOP-16EP, QSOP-24, QSOP-28	1,000	7
R-1, R-4, R-5, R-15	500	13
SC-70, SC-79, SOT-23, SOT-25, SOT-26, SOT-89, SOT-143, SOT-353, SOT-363, SOT-323, SOD-323	3,000	7

Tape and Reel Packaging for Surface Mount Components

Rev. V16

Reel Information (continued) ^{1,2}

Package Type	Max. Devices per Reel	Reel Diameter (inches)
SM-1, SM-55, SM-69	900	13
SM-2, SM-4, SM-7-1, SM-20, SM-23, SM-24, SM-41, SM-44	500	13
SM-3, SM-26, SM-28, SM-46, LSM6	300	13
SM-22	2,000	13
SM-52	2,500	13
SM-68, SM-74, SM-106, SM-108	500	13
SM-87, SM-89, SM-134	900	13
SOIC-8 (SO-8)	1,000	7
	3,000	13
	2,000 (E-Series)	13
SOIC 14 (SO-14), SOIC 16 (SO-16)	1,000	7
	3,000	13
SOIC-16 Wide Body (SOW-16), SOIC-24 (SO-24), SOW-24	1,000	13
SSOP-8	900	7
	3,000	13
SSOP-20, SSOP-24, SSOP 28	1,000	13
TSSOP-16, TSSOP-16EP	1,000	7
	2,500	13

1. See individual data sheets for part number ordering information.
2. Most device in tape and reel must be ordered in multiples of 100 pieces, with a minimum order quantity of either 200 or 500 pieces per part number. Consult factory for individual package types.