

Application Circuit Configuration

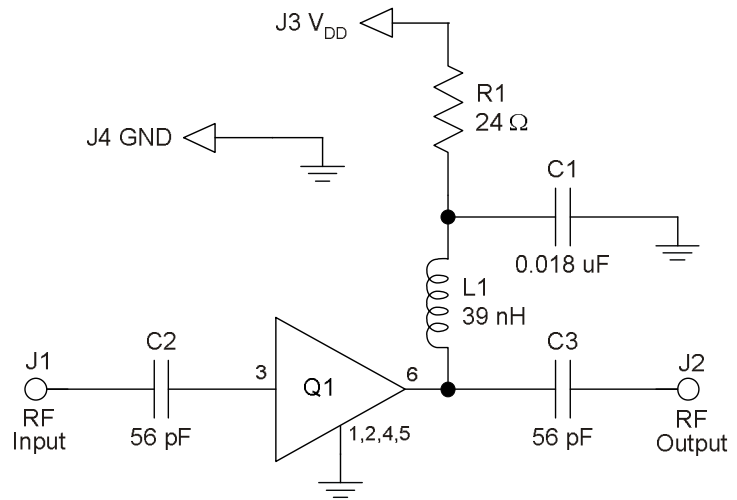
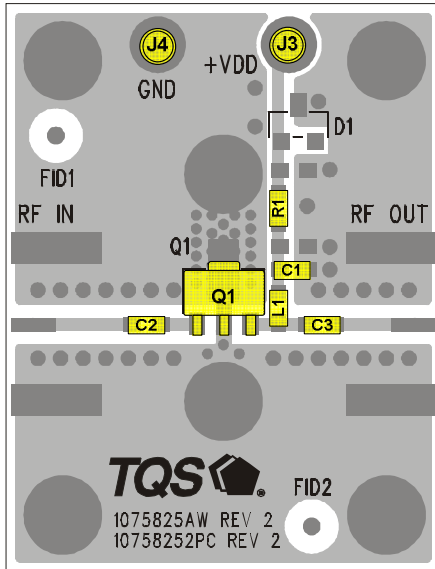

Notes:

1. See PC Board Layout, under Application Information section, for more information.
2. All components are of 0603 size unless otherwise stated.

Bill of Material: TQP369182-PCB

Reference Des.	Value	Description	Manufacturer	Part Number
Q1	n/a	Gain Block	TriQuint	TQP369182
C1	0.018 uF	Cap, Chip, 0603, 16V, X7R, 10%	various	
C2, C3	56 pF	Cap, Chip, 0603, 50V, NPO, 5%	various	
L1	39 nH	Inductor, 0603, 5%, CS Series	Coilcraft	
R1	24 Ω	Res, Chip, 0805, 1/10W, 5%	various	

Component Values for Specific Frequencies

Use the component values in this table for optimal operation at specific frequencies.

Reference Designator	Frequency (MHz)						
	50	500	900	1900	2200	2500	3500
L1	820 nH	220 nH	68 nH	27 nH	22 nH	18 nH	15 nH
C2, C3	.018 uF	1000 pF	100 pF	68 pF	68 pF	56 pF	39 pF

Bias Resistor Values for Various Supply Voltages

Select R1 to satisfy 45 mA operating current at the available supply voltage.

	V _{supply} (Volts)						
	5	6	7	8	9	10	12
R1 Value	24 Ω	47 Ω	68 Ω	91 Ω	110 Ω	130 Ω	180 Ω
Size	0805	1206	1210	1210	1210	2010	2010