

FEATURES

- Wide Operating V_{IN} Range: 3.5V to 60V
- Wide Negative V_{OUT} Range: -0.4V to Beyond -150V
- Low Operating I_Q = 70μA
- Strong High Voltage MOSFET Gate Driver
- Constant Frequency Current Mode Architecture
- Verified FMEA for Adjacent Pin Open/Short
- Selectable High Efficiency Burst Mode® Operation or Pulse-Skipping Mode at Light Loads
- Programmable Fixed Frequency: 50kHz to 850kHz
- Phase-Lockable Frequency: 75kHz to 750kHz
- Accurate Current Limit
- Programmable Soft-Start or Voltage Tracking
- Internal Soft-Start Guarantees Smooth Start-Up
- Low Shutdown I_Q = 7μA
- Available in Small 12-Lead Thermally Enhanced MSOP and DFN Packages

APPLICATIONS

- Industrial and Automotive Power Supplies
- Telecom Power Supplies
- Distributed Power Systems

DESCRIPTION

The LTC3863 is a robust, inverting DC/DC PMOS controller optimized for automotive and industrial applications. It drives a P-channel power MOSFET to generate a negative output and requires just a single inductor to complete the circuit. Output voltages from -0.4V to -150V are typically achievable with higher voltages possible, only limited by external components.

The LTC3863 offers excellent light load efficiency, drawing only 70μA quiescent current in a user programmable Burst Mode operation. Its peak current mode, constant frequency PWM architecture provides for good control of switching frequency and output current limit. The switching frequency can be programmed from 50kHz to 850kHz with an external resistor and can be synchronized to an external clock from 75kHz to 750kHz.

The LTC3863 offers programmable soft-start or output tracking. Safety features include overvoltage, overcurrent and short-circuit protection including frequency foldback.

The LTC3863 is available in thermally enhanced 12-lead MSOP and 3mm × 4mm DFN packages.

LT, LTC, LTM, OPTI-LOOP, Linear Technology, Burst Mode and the Linear logo are registered trademarks and Hot Swap is a trademark of Linear Technology Corporation. All other trademarks are the property of their respective owners. Protected by U.S. Patents including 5731694.

TYPICAL APPLICATION

4.5V to 16V Input, -5V/1.7A Output, 350kHz Inverting Converter

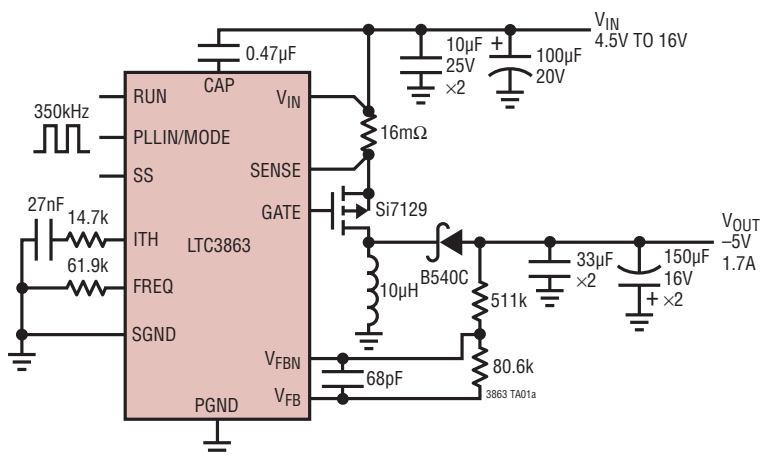

Efficiency

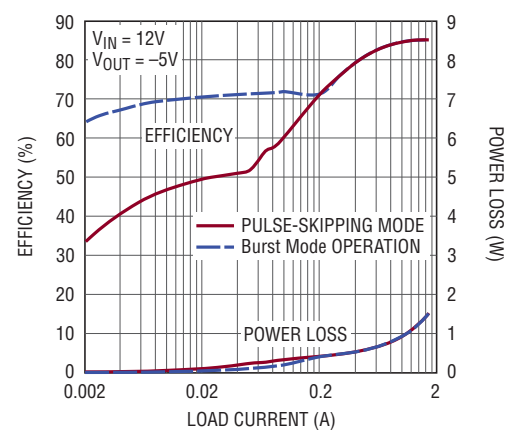

3863 TA01b

LTC3863

ABSOLUTE MAXIMUM RATINGS (Note 1)

Input Supply Voltage (V_{IN})	-0.3V to 65V	Operating Junction Temperature Range (Notes 2, 3, 4)	
$V_{IN}-V_{SENSE}$ Voltage	-0.3V to 6V	LTC3863E,I	-40°C to 125°C
$V_{IN}-V_{CAP}$ Voltage	-0.3V to 10V	LTC3863H	-40°C to 150°C
RUN Voltage	-0.3V to 65V	LTC3863MP	-55°C to 150°C
V_{FBN} , PLLIN/MODE Voltages	-0.3V to 6V	Storage Temperature Range	-65°C to 150°C
SS, ITH, FREQ, V_{FB} Voltages	-0.3V to 5V	Lead Temperature (Soldering, 10 sec)	
		MSOP Package	300°C

PIN CONFIGURATION

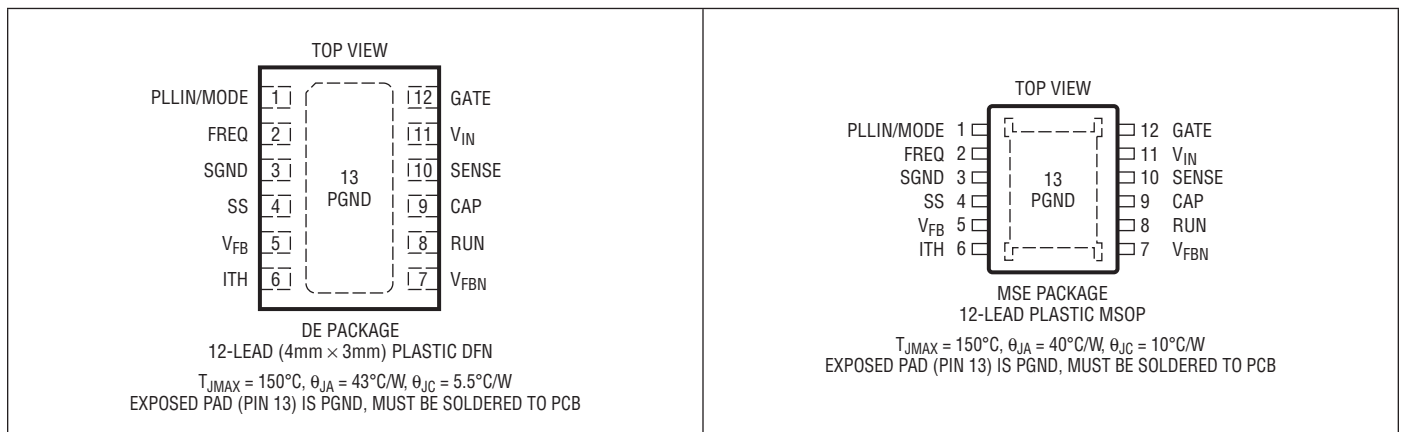

ORDER INFORMATION

LEAD FREE FINISH	TAPE AND REEL	PART MARKING*	PACKAGE DESCRIPTION	TEMPERATURE RANGE
LTC3863EMSE#PBF	LTC3863EMSE#TRPBF	3863	12-Lead Plastic MSOP	-40°C to 125°C
LTC3863IMSE#PBF	LTC3863IMSE#TRPBF	3863	12-Lead Plastic MSOP	-40°C to 125°C
LTC3863HMSE#PBF	LTC3863HMSE#TRPBF	3863	12-Lead Plastic MSOP	-40°C to 150°C
LTC3863MPMSE#PBF	LTC3863MPMSE#TRPBF	3863	12-Lead Plastic MSOP	-55°C to 150°C
LTC3863EDE#PBF	LTC3863EDE#TRPBF	3863	12-Lead (4mm × 3mm) Plastic DFN	-40°C to 125°C
LTC3863IDE#PBF	LTC3863IDE#TRPBF	3863	12-Lead (4mm × 3mm) Plastic DFN	-40°C to 125°C
LTC3863HDE#PBF	LTC3863HDE#TRPBF	3863	12-Lead (4mm × 3mm) Plastic DFN	-40°C to 150°C
LTC3863MPDE#PBF	LTC3863MPDE#TRPBF	3863	12-Lead (4mm × 3mm) Plastic DFN	-55°C to 150°C

Consult LTC Marketing for parts specified with wider operating temperature ranges. *The temperature grade is identified by a label on the shipping container.

Consult LTC Marketing for information on non-standard lead based finish parts.

For more information on lead free part marking, go to: <http://www.linear.com/leadfree/>

For more information on tape and reel specifications, go to: <http://www.linear.com/tapeandreeel/>

ELECTRICAL CHARACTERISTICS

The ● denotes the specifications which apply over the specified operating junction temperature range, otherwise specifications are at $T_A = 25^\circ\text{C}$. $V_{IN} = 12\text{V}$, unless otherwise noted. (Note 4)

SYMBOL	PARAMETER	CONDITIONS	MIN	TYP	MAX	UNITS	
Input Supply							
V_{IN}	Input Voltage Operating Range		3.5		60	V	
V_{UVLO}	Undervoltage Lockout	$(V_{IN}-V_{CAP})$ Ramping Up Threshold	● 3.25	3.50	3.8	V	
		$(V_{IN}-V_{CAP})$ Ramping Down Threshold Hysteresis	● 3.00	3.25 0.25	3.50	V V	
I_Q	Input DC Supply Current						
	Pulse-Skipping Mode	PLLIN/MODE = 0V, FREQ = 0V, $V_{FB} = 0.83\text{V}$ (No Load)		0.77	1.2	mA	
	Burst Mode Operation	PLLIN/MODE = Open, FREQ = 0V, $V_{FB} = 0.83\text{V}$ (No Load)		50	70	μA	
	Shutdown Supply Current	RUN = 0V		7	12	μA	
Output Sensing							
V_{REG}	Regulated Feedback Voltage $V_{REG} = (V_{FB} - V_{FBN})$	$V_{ITH} = 1.2\text{V}$ (Note 5)	● 0.791	0.800	0.809	V	
$\frac{\Delta V_{REG}}{\Delta V_{IN}}$	Feedback Voltage Line Regulation	$V_{IN} = 3.8\text{V}$ to 60V (Note 5)		-0.005	0.005	%/V	
$\frac{\Delta V_{REG}}{\Delta V_{ITH}}$	Feedback Voltage Load Regulation	$V_{ITH} = 0.6\text{V}$ to 1.8V (Note 5)		-0.1	-0.015	0.1	%
$g_{m(EA)}$	Error Amplifier Transconductance	$V_{ITH} = 1.2\text{V}$, $\Delta I_{ITH} = \pm 5\mu\text{A}$ (Note 5)		1.8		mS	
I_{FBN}	Feedback Negative Input Bias Current		-50	-10	50	nA	
Current Sensing							
V_{ILIM}	Current Limit Threshold ($V_{IN}-V_{SENSE}$)	$V_{FB} = 0.77\text{V}$	● 85	95	103	mV	
I_{SENSE}	SENSE Pin Input Current	$V_{SENSE} = V_{IN}$		0.1	2	μA	
Start-Up and Shutdown							
V_{RUN}	RUN Pin Enable Threshold	V_{RUN} Rising	● 1.22	1.26	1.32	V	
V_{RUNHYS}	RUN Pin Hysteresis			150		mV	
I_{SS}	Soft-Start Pin Charging Current	$V_{SS} = 0\text{V}$		10		μA	
Switching Frequency and Clock Synchronization							
f	Programmable Switching Frequency	$R_{FREQ} = 24.9\text{k}\Omega$		375	105	kHz	
		$R_{FREQ} = 64.9\text{k}\Omega$			440	505	kHz
		$R_{FREQ} = 105\text{k}\Omega$			810		kHz
f_{LO}	Low Switching Frequency	FREQ = 0V	320	350	380	kHz	
f_{HI}	High Switching Frequency	FREQ = Open	485	535	585	kHz	
f_{SYNC}	Synchronization Frequency		● 75		750	kHz	
$V_{CLK(IH)}$	Clock Input High Level into PLLIN/MODE		● 2			V	
$V_{CLK(LO)}$	Clock Input Low Level into PLLIN/MODE		●		0.5	V	
f_{FOLD}	Foldback Frequency as Percentage of Programmable Frequency	$V_{FB} = 0\text{V}$, $V_{FREQ} = 0\text{V}$		18		%	
$t_{ON(MIN)}$	Minimum On-Time			220		ns	

ELECTRICAL CHARACTERISTICS

The ● denotes the specifications which apply over the specified operating junction temperature range, otherwise specifications are at $T_A = 25^\circ\text{C}$. $V_{IN} = 12\text{V}$, unless otherwise noted. (Note 4)

SYMBOL	PARAMETER	CONDITIONS	MIN	TYP	MAX	UNITS
Gate Driver						
V_{CAP}	Gate Bias LDO Output Voltage ($V_{IN}-V_{CAP}$)	$I_{GATE} = 0\text{mA}$	● 7.6	8.0	8.5	V
$V_{CAPDROP}$	Gate Bias LDO Dropout Voltage	$V_{IN} = 5\text{V}$, $I_{GATE} = 15\text{mA}$		0.2	0.5	V
$\Delta V_{CAP(LINE)}$	Gate Bias LDO Line Regulation	$9\text{V} \leq V_{IN} \leq 60\text{V}$, $I_{GATE} = 0\text{mA}$		0.002	0.03	%/V
$\Delta V_{CAP(LOAD)}$	Gate Bias LDO Load Regulation	Load = 0mA to 20mA	-3.5			%
R_{UP}	Gate Pull-Up Resistance	Gate High		2		Ω
R_{DN}	Gate Pull-Down Resistance	Gate Low		0.9		Ω
Overvoltage						
V_{FBOV}	V_{FB} Overvoltage Lockout Threshold	GATE Going High without Delay, $V_{FB(OV)}-V_{FB(NOM)}$ in Percent		10		%

Note 1: Stresses beyond those listed under Absolute Maximum Ratings may cause permanent damage to the device. Exposure to any Absolute Maximum Rating condition for extended periods may affect device reliability and lifetime.

Note 2: Continuous operation above the specified maximum operating junction temperature may impair device reliability or permanently damage the device.

Note 3: The junction temperature (T_J in $^\circ\text{C}$) is calculated from the ambient temperature (T_A in $^\circ\text{C}$) and power dissipation (P_D in Watts) as follows:

$$T_J = T_A + (P_D \cdot \theta_{JA})$$

where θ_{JA} (in $^\circ\text{C}/\text{W}$) is the package thermal impedance provided in the Pin Configuration section for the corresponding package.

Note 4: The LTC3863 is tested under pulsed load conditions such that $T_J \approx T_A$. The LTC3863E is guaranteed to meet performance specifications from 0°C to 85°C operating junction temperature range. The LTC3863E

specifications over the -40°C to 125°C operating junction temperature range are assured by design, characterization and correlation with statistical process controls. The LTC3863I is guaranteed to meet performance specifications over the -40°C to 125°C operating junction temperature range, the LTC3863H is guaranteed over the -40°C to 150°C operating junction temperature range, and the LTC3863MP is guaranteed and tested over the full -55°C to 150°C operating junction temperature range. High junction temperatures degrade operating lifetimes; operating lifetime is derated for junction temperatures greater than 125°C . The maximum ambient temperature consistent with these specifications is determined by specific operating conditions in conjunction with board layout, the rated package thermal impedance and other environmental factors.

Note 5: The LTC3863 is tested in a feedback loop that adjust V_{REG} or ($V_{FB} - V_{FBN}$) to achieve a specified error amplifier output voltage (on ITH pin).

TYPICAL PERFORMANCE CHARACTERISTICS $T_A = 25^\circ\text{C}$, unless otherwise noted.

Pulse-Skipping Mode Operation Waveforms

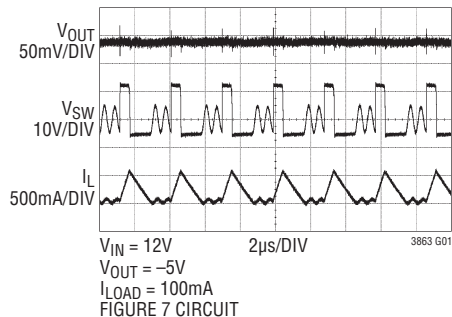

Burst Mode Operation Waveforms

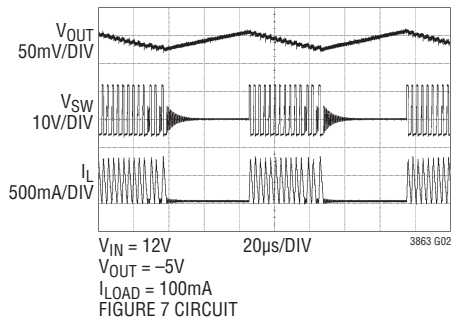

Transient Response: Burst Mode Operation

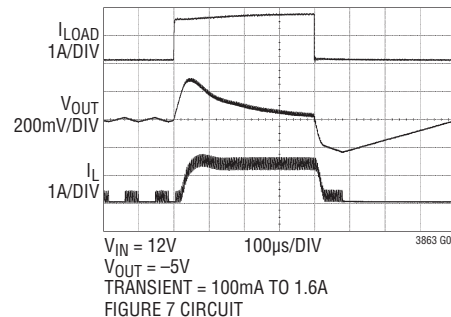

Transient Response: Pulse-Skipping Mode Operation

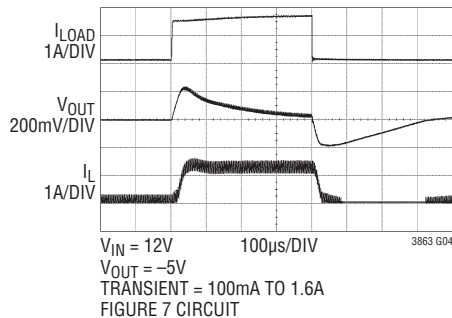

Transient Response: Rising Edge Pulse-Skipping Mode Operation

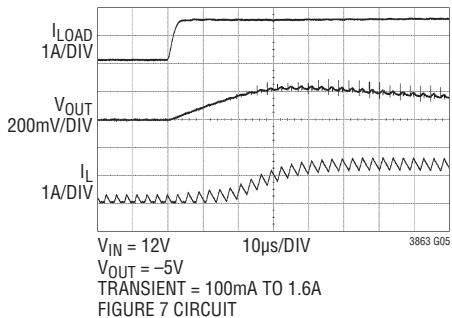

Transient Response: Falling Edge Pulse-Skipping Mode Operation

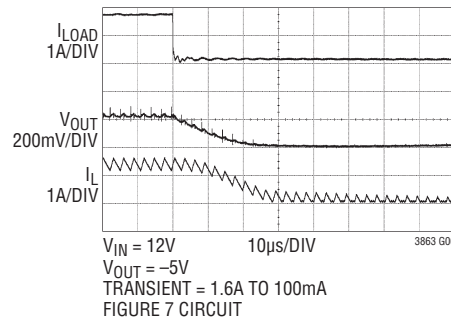

Normal Soft-Start

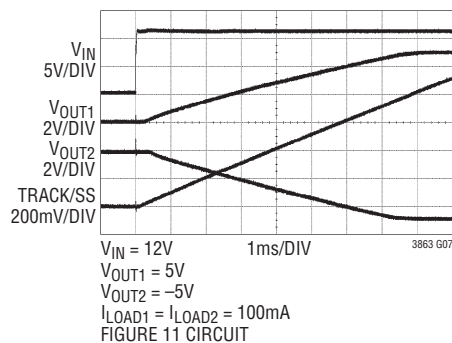

Soft-Start into a Prebiased Output

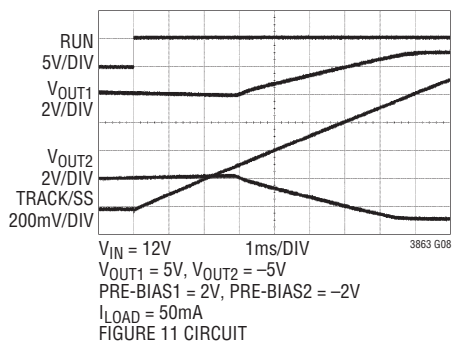

Output Tracking

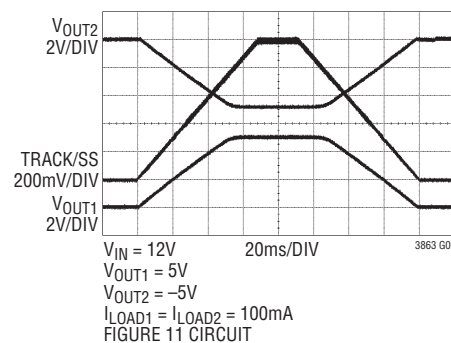

TYPICAL PERFORMANCE CHARACTERISTICS $T_A = 25^\circ\text{C}$, unless otherwise noted.

Overcurrent Protection

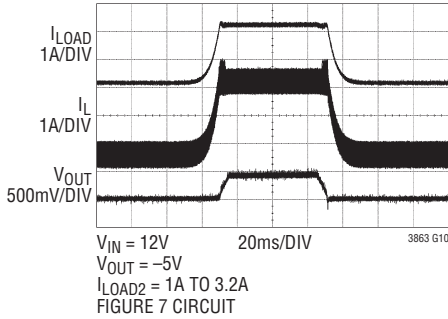

Short-Circuit Protection

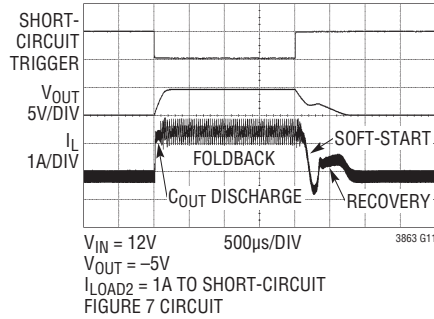

V_{IN} Line Transient Behavior

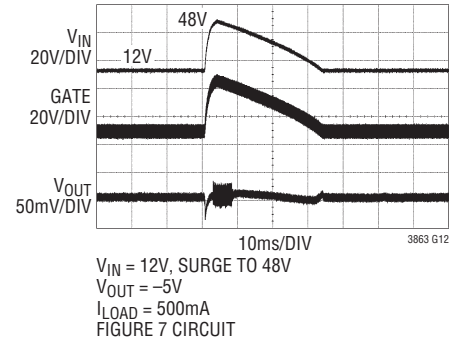

Burst Mode Input Current Over Input Voltage (No Load)

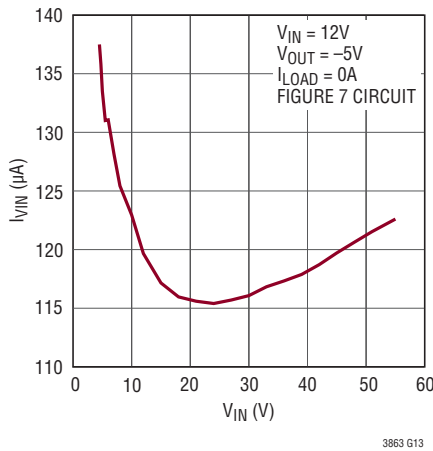

Pulse-Skipping Mode Input Current Over Input Voltage (No Load)

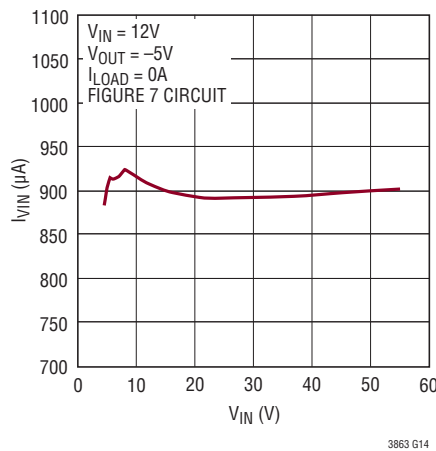

Shutdown Current Over Input Voltage

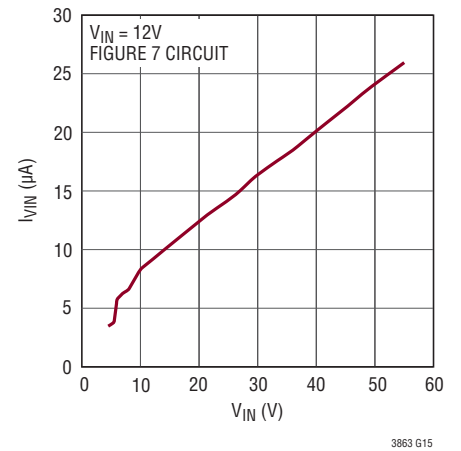

Output Regulation Over Input Voltage

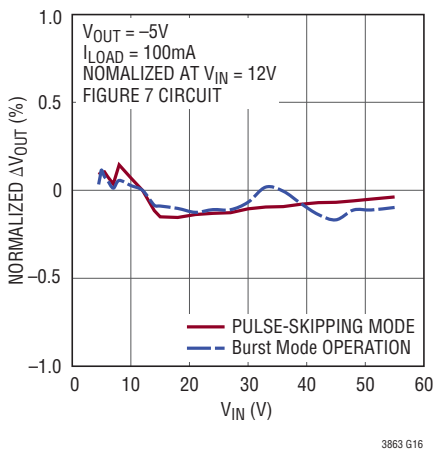

Output Regulation Over Load Current

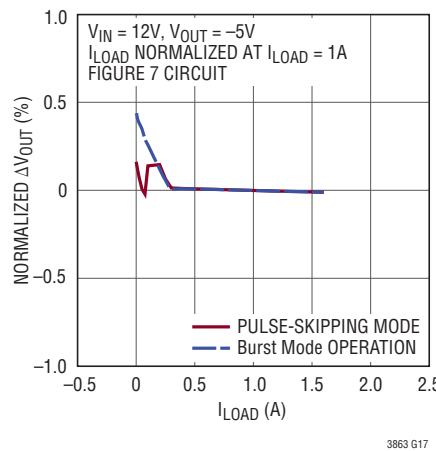

Output Regulation Over Temperature

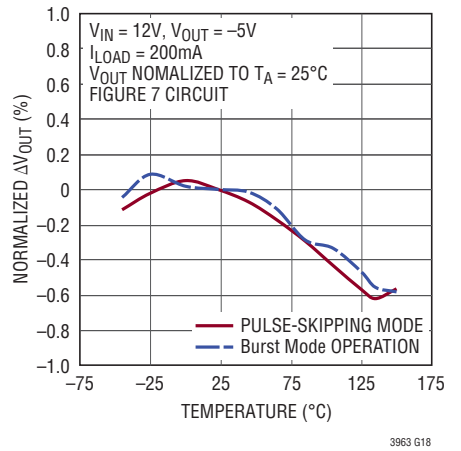

TYPICAL PERFORMANCE CHARACTERISTICS $T_A = 25^\circ\text{C}$, unless otherwise noted.

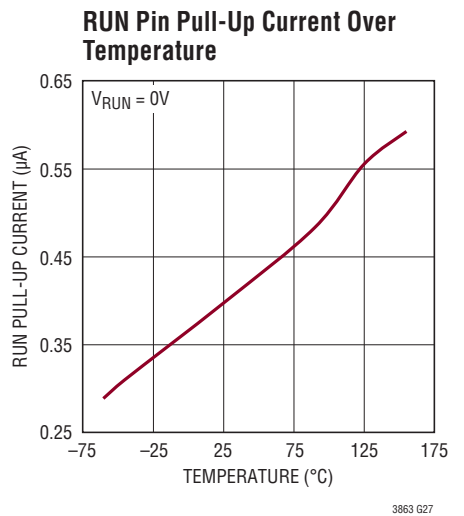
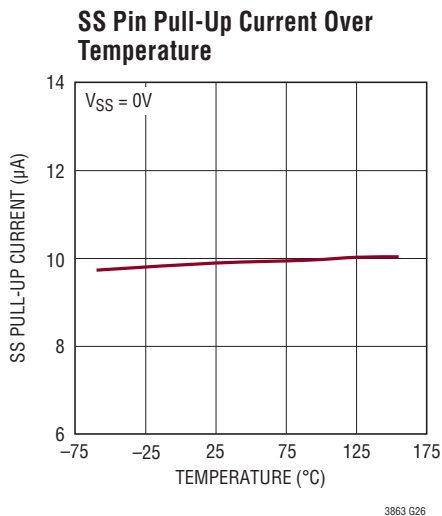
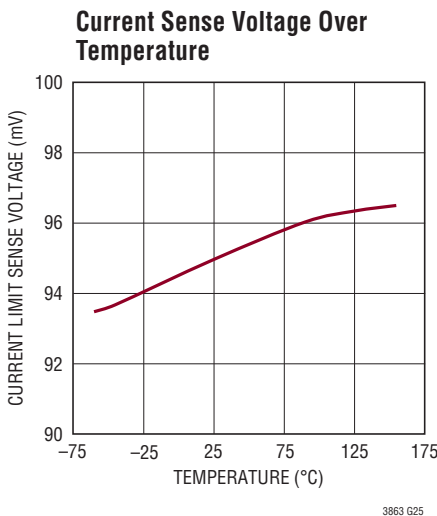
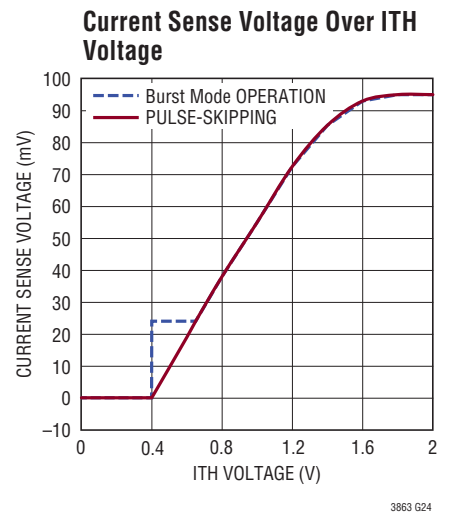
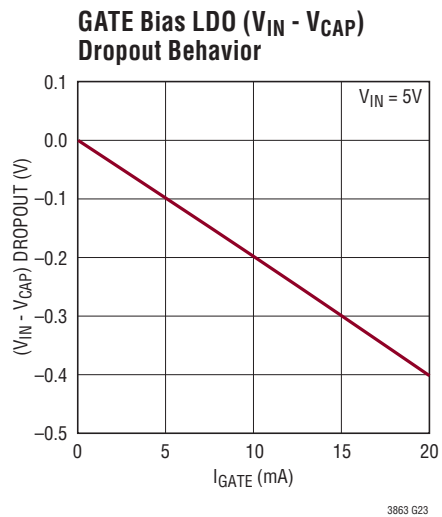
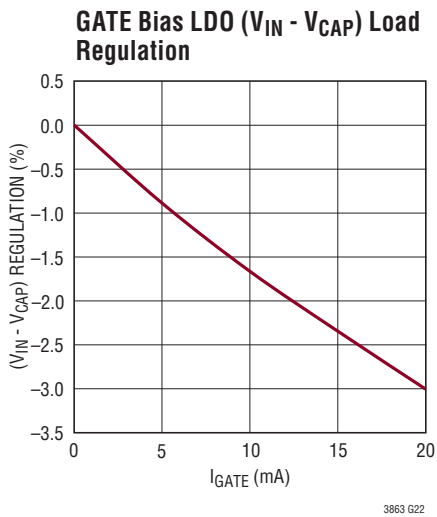
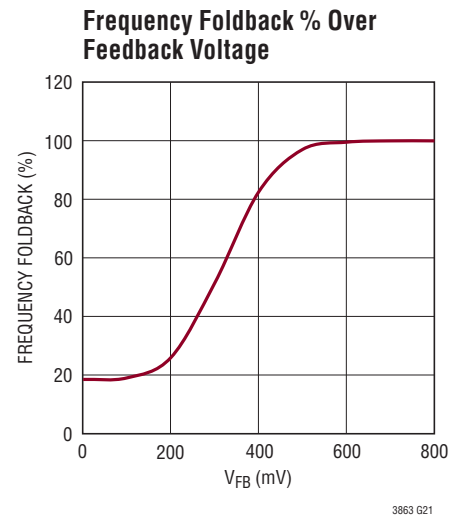
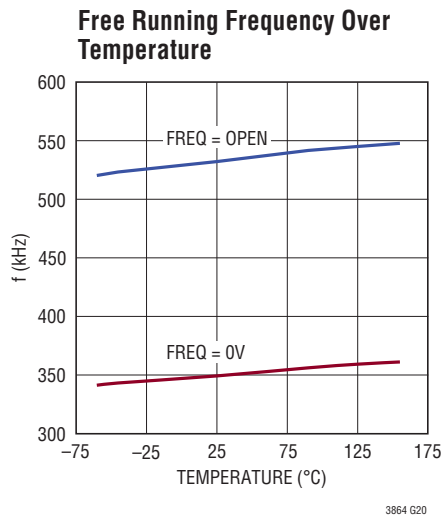
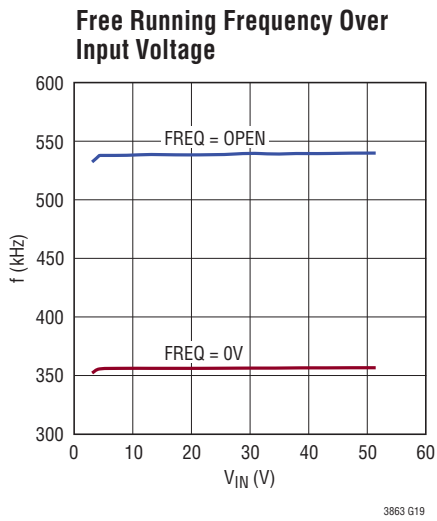

PIN FUNCTIONS

PLLIN/MODE (Pin 1): External Reference Clock Input and Burst Mode Enable/Disable. When an external clock is applied to this pin, the internal phase-locked loop will synchronize the turn-on edge of the gate drive signal with the rising edge of the external clock. When no external clock is applied, this input determines the operation during light loading. Floating this pin selects low I_Q (40 μ A) Burst Mode operation. Pulling to ground selects pulse-skipping mode operation.

FREQ (Pin 2): Switching Frequency Setpoint Input. The switching frequency is programmed by an external setpoint resistor R_{FREQ} connected between the FREQ pin and signal ground. An internal 20 μ A current source creates a voltage across the external setpoint resistor to set the internal oscillator frequency. Alternatively, this pin can be driven directly by a DC voltage to set the oscillator frequency. Grounding selects a fixed operating frequency of 350kHz. Floating selects a fixed operating frequency of 535kHz.

SGND (Pin 3): Ground Reference for Small-Signal Analog Component (Signal Ground). Signal ground should be used as the common ground for all small-signal analog inputs and compensation components. Connect the signal ground to the power ground (ground reference for power components) only at one point using a single PCB trace.

SS (Pin 4): Soft-Start and External Tracking Input. The LTC3863 regulates the feedback voltage to the smaller of 0.8V or the voltage on the SS pin. An internal 10 μ A pull-up current source is connected to this pin. A capacitor to ground at this pin sets the ramp time to the final regulated output voltage. Alternatively, another voltage supply connected through a resistor divider to this pin allows the output to track the other supply during start-up.

V_{FB} (Pin 5): Output Feedback Sense. A resistor divider from the regulated output point to this pin sets the output voltage. The LTC3863 will nominally regulate V_{FB} to the internal reference value of 0.8V. If V_{FB} is less than 0.4V, the switching frequency will linearly decrease and fold back to about one-fifth of the internal oscillator frequency to reduce the minimum duty cycle.

ITH (Pin 6): Current Control Threshold and Controller Compensation Point. This pin is the output of the error amplifier and the switching regulator's compensation

point. The voltage ranges from 0V to 2.9V, with 0.8V corresponding to zero sense voltage (zero current).

V_{FBN} (Pin 7): Feedback Input for an Inverting PWM Controller. Connect V_{FBN} to the center of a resistor divider between the output and V_{FB} . The V_{FBN} threshold is 0V. To defeat the inverting amplifier and use the LTC3863 as an LTC3864 (noninverting buck), tie $V_{FBN} > 2V$.

RUN (Pin 8): Digital Run Control Input. A RUN voltage above the 1.26V threshold enables normal operation, while a voltage below the threshold shuts down the controller. An internal 0.4 μ A current source pulls the RUN pin up to about 3.3V. The RUN pin can be connected to an external power supply up to 60V.

CAP (Pin 9): Gate Driver (–) Supply. A low ESR ceramic bypass capacitor of at least 0.1 μ F or 10X the effective C_{MILLER} of the P-channel power MOSFET, is required from V_{IN} to this pin to serve as a bypass capacitor for the internal regulator. To ensure stable low noise operation, the bypass capacitor should be placed adjacent to the V_{IN} and CAP pins and connected using the same PCB metal layer.

SENSE (Pin 10): Current Sense Input. A sense resistor, R_{SENSE} , from the V_{IN} pin to the SENSE pin sets the maximum current limit. The peak inductor current limit is equal to $95mV/R_{SENSE}$. For accuracy, it is important that the V_{IN} pin and the SENSE pin route directly to the current sense resistor and make a Kelvin (4-wire) connection.

V_{IN} (Pin 11): Chip Power Supply. A minimum bypass capacitor of 0.1 μ F is required from the V_{IN} pin to power ground. For best performance use a low ESR ceramic capacitor placed near the V_{IN} pin.

GATE (Pin 12): Gate Drive Output for External P-Channel MOSFET. The gate driver bias supply voltage ($V_{IN}-V_{CAP}$) is regulated to 8V when V_{IN} is greater than 8V. The gate driver is disabled when ($V_{IN}-V_{CAP}$) is less than 3.5V (typical), 3.8V maximum in start-up and 3.25V (typical) 3.5V maximum in normal operation.

PGND (Exposed Pad Pin 13): Ground Reference for Power Components (Power Ground). The PGND exposed pad must be soldered to the circuit board for electrical contact and for rated thermal performance of the package. Connect signal ground to power ground only at one point using a single PCB trace.

FUNCTIONAL DIAGRAM

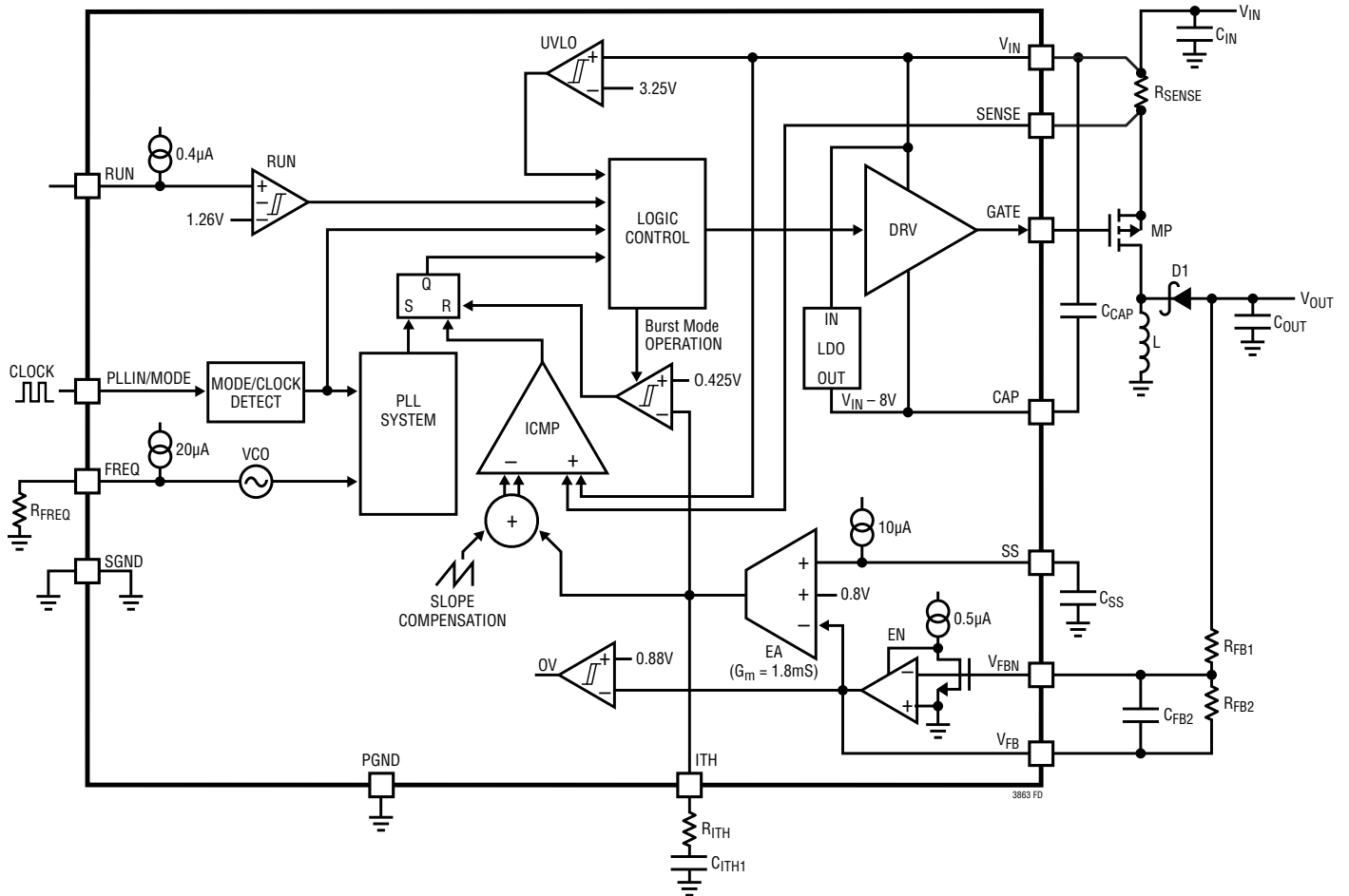

OPERATION

LTC3863 Main Control Loop

The LTC3863 is a nonsynchronous inverting PMOS controller, where an inverting amplifier is used to sense the negative output voltage below ground. The LTC3863 uses a peak current mode control architecture to regulate the output. A feedback resistor, R_{FB1} , is placed between V_{OUT} and V_{FBN} and a second resistor, R_{FB2} , is placed between V_{FBN} and V_{FB} . The LTC3863 has a trimmed internal reference, V_{REF} , that is equal to $(V_{FB} - V_{FBN})$. The output voltage is equal to $-(R_{FB1}/R_{FB2}) \cdot V_{REF}$ where V_{REF} is equal to 800mV in normal regulation.

The LTC3863 can also be configured as a noninverting step-down buck regulator when the V_{FBN} node is pulled greater than 2V but held less than 5V, which disables the internal inverting amplifier. A feedback resistor, R_{FB1} , is placed between V_{OUT} and V_{FB} and a second resistor, R_{FB2} , is placed between V_{FB} and SGND. In the noninverting buck mode the V_{FB} input is compared to the internal reference, V_{REF} , by a transconductance error amplifier (EA). The internal reference can be either a fixed 0.8V reference, V_{REF} , or the voltage input on the SS pin. In normal operation V_{FB} regulates to the internal 0.8V reference voltage. The output voltage in normal regulation is equal to $(R_{FB1} + R_{FB2})/R_{FB2} \cdot 800\text{mV}$.

In soft-start or tracking mode when the SS pin voltage is less than the internal 0.8V reference voltage, V_{FB} will regulate to the SS pin voltage. The error amplifier output connects to the ITH (current [I] threshold [TH]) pin. The voltage level on the ITH pin is then summed with a slope compensation ramp to create the peak inductor current set point.

The peak inductor current is measured through a sense resistor, R_{SENSE} , placed across the V_{IN} and SENSE pins.

The resultant differential voltage from V_{IN} to SENSE is proportional to the inductor current and is compared to the peak inductor current setpoint. During normal operation the P-channel power MOSFET is turned on when the clock leading edge sets the SR latch through the S input. The P-channel MOSFET is turned off through the SR latch R input when the differential voltage from V_{IN} to SENSE is greater than the peak inductor current setpoint and the current comparator, ICMP, trips high.

Power CAP and V_{IN} Undervoltage Lockout (UVLO)

Power for the P-channel MOSFET gate driver is derived from the CAP pin. The CAP pin is regulated to 8V below V_{IN} in order to provide efficient P-channel operation. The power for the V_{CAP} supply comes from an internal LDO, which regulates the V_{IN} -CAP differential voltage. A minimum capacitance of 0.1 μF (low ESR ceramic) is required between V_{IN} and CAP to assure stability.

For $V_{IN} \leq 8\text{V}$, the LDO will be in dropout and the CAP voltage will be at ground, i.e., the V_{IN} -CAP differential voltage will equal V_{IN} . If V_{IN} -CAP is less than 3.25V (typical), the LTC3863 enters a UVLO state where the GATE is prevented from switching and most internal circuitry is shut down. In order to exit UVLO, the V_{IN} -CAP voltage would have to exceed 3.5V (typical).

Shutdown and Soft-Start

When the RUN pin is below 0.7V, the controller and most internal circuits are disabled. In this micropower shutdown state, the LTC3863 draws only 7 μA . Releasing the RUN pin allows a small internal pull-up current to pull the RUN pin above 1.26V and enable the controller. The RUN pin can be pulled up to an external supply of up to 60V or it can be driven directly by logic levels.

OPERATION

The start-up of the output voltage V_{OUT} is controlled by the voltage on the SS pin. When the voltage on the SS pin is less than the 0.8V internal reference, the V_{FB} pin is regulated to the voltage on the SS pin. This allows the SS pin to be used to program a soft-start by connecting an external capacitor from the SS pin to signal ground. An internal 10 μ A pull-up current charges this capacitor, creating a voltage ramp on the SS pin. As the SS voltage rises from 0V to 0.8V, the output voltage V_{OUT} rises smoothly from zero to its final value.

Alternatively, the SS pin can be used to cause the start-up of V_{OUT} to track that of another supply. Typically, this requires connecting the SS pin to an external resistor divider from the other supply to ground (see Applications Information). Under shutdown or UVLO, the SS pin is pulled to ground and prevented from ramping up.

If the slew rate of the SS pin is greater than 1.2V/ms, the output will track an internal soft-start ramp instead of the SS pin. The internal soft-start will guarantee a smooth start-up of the output under all conditions, including in the case of a short-circuit recovery where the output voltage will recover from near ground.

Light Load Current Operation (Burst Mode Operation or Pulse-Skipping Mode)

The LTC3863 can be enabled to enter high efficiency Burst Mode operation or pulse-skipping mode at light loads. To select pulse-skipping operation, tie the PLLIN/MODE pin to signal ground. To select Burst Mode operation, float the PLLIN/MODE pin.

In Burst Mode operation, if the V_{FB} is higher than the reference voltage, the error amplifier will decrease the voltage on the ITH pin. When the ITH voltage drops below 0.425V, the internal sleep signal goes high, enabling sleep mode. The ITH pin is then disconnected from the output of the error amplifier and held at 0.45V.

In sleep mode, much of the internal circuitry is turned off, reducing the quiescent current to 70 μ A while the load current is supplied by the output capacitor. As the output voltage and hence the feedback voltage decreases, the error amplifier's output will rise. When the output voltage drops enough, the ITH pin is reconnected to the output of the error amplifier, the sleep signal goes low, and the controller resumes normal operation by turning on the external P-channel MOSFET on the next cycle of the internal oscillator. In Burst Mode operation, the peak inductor current has to reach at least 25% of current limit for the current comparator, ICMP, to trip and turn the P-channel MOSFET back off, even though the ITH voltage may indicate a lower current setpoint value.

When the PLLIN/MODE pin is connected for pulse-skipping mode, the LTC3863 will skip pulses during light loads. In this mode, ICMP may remain tripped for several cycles and force the external MOSFET to stay off, thereby skipping pulses. This mode offers the benefits of smaller output ripple, lower audible noise, and reduced RF interference, at the expense of lower efficiency when compared to Burst Mode operation.

Frequency Selection and Clock Synchronization

The switching frequency of the LTC3863 can be selected using the FREQ pin. If the PLLIN/MODE pin is not being driven by an external clock source, the FREQ pin can be tied to signal ground, floated, or programmed through an external resistor. Tying FREQ to signal ground selects 350kHz, while floating selects 535kHz. Placing a resistor between FREQ and signal ground allows the frequency to be programmed between 50kHz and 850kHz.

The phase-locked loop (PLL) on the LTC3863 will synchronize the internal oscillator to an external clock source when connected to the PLLIN/MODE pin. The PLL forces the turn-on edge of the external P-channel MOSFET to be aligned with the rising edge of the synchronizing signal.

OPERATION

The oscillator's default frequency is based on the operating frequency set by the FREQ pin. If the oscillator's default frequency is near the external clock frequency, only slight adjustments are needed for the PLL to synchronize the external P-channel MOSFET's turn-on edge to the rising edge of the external clock. This allows the PLL to lock rapidly without deviating far from the desired frequency.

The PLL is guaranteed from 75kHz to 750kHz. The clock input levels should be greater than 2V for HI and less than 0.5V for LO.

Fault Protection

When the V_{FB} voltage is above +10% of the regulated voltage of 0.8V, this is considered as an overvoltage condition and the external P-MOSFET is immediately turned off and prevented from ever turning on until V_{FB} returns below +7.5%.

In the event of an output short circuit or overcurrent condition that causes the output voltage to drop significantly while in current limit, the LTC3863 operating frequency will fold back. Anytime the output feedback V_{FB} voltage is less than 50% of the 0.8V internal reference (i.e., 0.4V), frequency foldback is active. The frequency will continue to drop as V_{FB} drops until reaching a minimum foldback frequency of about 18% of the setpoint frequency. Frequency foldback is designed, in combination with peak current limit, to limit current in start-up and short-circuit conditions. Setting the foldback frequency as a percentage of operating frequency assures that start-up characteristics scale appropriately with operating frequency.

APPLICATIONS INFORMATION

The LTC3863 is a nonsynchronous inverting, current mode, constant frequency PWM controller. It drives an external P-channel power MOSFET which connects to a Schottky power diode acting as the commutating catch diode. The input range extends from 3.5V to 60V. The output range has no theoretical minimum or maximum, but the duty factor and external components practically limit the output to one-tenth and ten times the input voltage. Higher output ratios can be obtained with transformers and more efficient external components.

The LTC3863 offers a highly efficient Burst Mode operation with 70 μ A quiescent current, which delivers outstanding efficiency in light load operation. The LTC3863 is a low pin count, robust and easy-to-use inverting power supply solution in applications which require high efficiency and operate with widely varying input and output voltages.

The typical application on the front page is a basic LTC3863 application circuit. The LTC3863 can sense the inductor current through a high side series sense resistor, R_{SENSE} , placed between V_{IN} and the source of the external P-channel MOSFET. Once the required output voltage and operating frequency have been determined, external component selection is driven by load requirements, and begins with the selection of inductor and R_{SENSE} . Next, the power MOSFET and catch diode are selected. Finally, input and output capacitors are selected.

Output Voltage Programming

The output voltage is programmed by connecting a feedback resistor divider from the output to the V_{FB} pin as shown in Figure 1. The output voltage in steady-state operation is set by the feedback resistors according to the equation:

$$V_{OUT} = -0.8V \cdot \frac{R_{FB1}}{R_{FB2}}$$

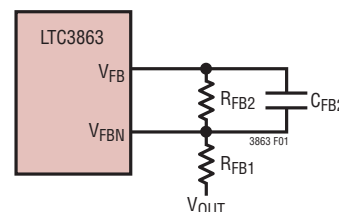

Figure 1. Setting the Output Voltage

Great care should be taken to route the V_{FB} and V_{FBN} lines away from noise sources, such as the inductor or SW node or the GATE signal that drives the external P-channel MOSFET.

The integrator capacitor, C_{FB2} , should be sized to ensure the negative sense amplifier gain rolls off and limits high frequency gain peaking in the DC/DC control loop. The integrator capacitor pole can be safely set to be two times the switching frequency without affecting the DC/DC phase margin according to the following equation. It is highly recommended that C_{FB2} be used in most applications.

$$C_{FB2} = \frac{1}{2 \cdot \pi \cdot 2 \cdot \text{FREQ}_{SW}}$$

Switching Frequency and Clock Synchronization

The choice of operating frequency is a trade-off between efficiency and component size. Lowering the operating frequency improves efficiency by reducing MOSFET switching losses but requires larger inductance and/or capacitance to maintain low output ripple voltage. Conversely, raising the operating frequency degrades efficiency but reduces component size.

APPLICATIONS INFORMATION

The LTC3863 can free-run at a user programmed switching frequency, or it can synchronize with an external clock to run at the clock frequency. When the LTC3863 is synchronized, the GATE pin will synchronize in phase with the rising edge of the applied clock in order to turn the external P-channel MOSFET on. The switching frequency of the LTC3863 is programmed with the FREQ pin, and the external clock is applied at the PLLIN/MODE pin. Table 1 highlights the different states in which the FREQ pin can be used in conjunction with the PLLIN/MODE pin.

Table 1

FREQ PIN	PLLIN/MODE PIN	FREQUENCY
OV	DC Voltage	350kHz
Floating	DC Voltage	535kHz
Resistor to GND	DC Voltage	50kHz to 850kHz
Either of the Above	External Clock	Phase Locked to External Clock

The free-running switching frequency can be programmed from 50kHz to 850kHz by connecting a resistor from FREQ to signal ground. The resulting switching frequency as a function of resistance on the FREQ pin is shown in Figure 2.

Set the free-running frequency to the desired synchronization frequency using the FREQ pin so that the internal oscillator is prebiased approximately to the synchronization frequency. While it is not required that the free-running frequency be near the external clock frequency, doing so will minimize synchronization time.

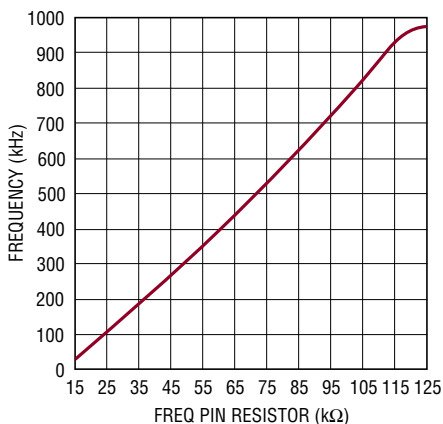

Figure 2. Switching Frequency vs Resistor on FREQ

Inductor Selection

Operating frequency, inductor selection, capacitor selection and efficiency are interrelated. Higher operating frequencies allow the use of smaller inductors, smaller capacitors, but result in lower efficiency because of higher MOSFET gate charge and transition losses. In addition to this basic trade-off, the selection of inductor value is also influenced by other factors.

Small inductor values result in large inductor ripple currents, large output voltage ripples and low efficiency due to higher core and conduction loss. Large inductor ripple currents result in high inductor peak currents, which require physically large inductors with large magnetic cross sections and higher saturation current ratings.

The value of the inductor can also impact the stability of the feedback loop. In continuous mode, the buck-boost converter transfer function has a right-half plane zero at a frequency that is inversely proportional to the value of the inductor. As a result, large inductor values can move this zero to a frequency that is low enough to degrade the phase margin of the feedback loop. Large inductor values also tend to degrade stability due to low noise margin caused from low ripple current. Additionally, large value inductors can lead to slow transient response due to slow inductor current ramping time.

For an inverting buck-boost converter operating in continuous conduction mode (CCM), given the desired input, output voltages and switching frequency, the peak-to-peak inductor ripple current is determined by the inductor value:

$$\Delta I_{L(\text{CCM})} = \frac{V_{\text{IN}} \cdot D}{L \cdot f} = \frac{V_{\text{IN}} \cdot (|V_{\text{OUT}}| + V_{\text{D}})}{L \cdot f \cdot (V_{\text{IN}} + |V_{\text{OUT}}| + V_{\text{D}})}$$

where V_{D} is the diode forward conduction voltage. In cases where $V_{\text{OUT}} \gg V_{\text{D}}$, V_{D} can be ignored. D is the duty factor and is given as:

$$D = \frac{|V_{\text{OUT}}| + V_{\text{D}}}{V_{\text{IN}} + |V_{\text{OUT}}| + V_{\text{D}}} \quad (0 < D < 1)$$

APPLICATIONS INFORMATION

The duty factor increases with increasing V_{OUT} and decreasing V_{IN} . For a given V_{OUT} , the maximum duty factor occurs at minimum V_{IN} .

A typical starting point for selecting an inductor is to choose the inductance such that the maximum peak-to-peak inductor ripple current, $\Delta I_{L(MAX)}$, is set to 40% ~ 50% of the inductor average current, $I_{L(AVG)}$, at maximum load current. Since $\Delta I_{L(MAX)}$ occurs at maximum V_{IN} in continuous mode, the inductance is calculated at maximum V_{IN} :

$$L = \frac{V_{IN(MAX)}^2 \cdot (|V_{OUT}| + V_D)}{0.4 \cdot I_{OUT(MAX)} \cdot f \cdot (V_{IN(MAX)} + |V_{OUT}| + V_D)^2}$$

The inductance can be further adjusted to achieve specific design optimization of efficiency, output ripple, component size and loop response.

Once the inductance value has been determined, the type of inductor must be selected. Core loss is independent of core size for a given inductor value, but it is very dependent on the inductance selected. As inductance increases, core losses decrease. Unfortunately, increased inductance requires more turns of wire and therefore, copper losses will increase.

High efficiency converters generally cannot tolerate the core loss of low cost powdered iron cores, forcing the use of more expensive ferrite materials. Ferrite designs have very low core loss and are preferred at high switching frequencies, so design goals can concentrate on copper loss and preventing saturation. Ferrite core material saturates hard, which means that inductance collapses abruptly when the peak design current is exceeded. This will result in an abrupt increase in inductor ripple current and output voltage ripple. Do not allow the core to saturate!

A variety of inductors are available from manufacturers such as Sumida, Panasonic, Coiltronics, Coilcraft, Toko, Vishay, Pulse and Würth.

Current Sensing and Current Limit Programming

The LTC3863 senses the inductor current through a current sense resistor, R_{SENSE} , placed across the V_{IN} and SENSE pins. The voltage across the resistor, V_{SENSE} , is proportional to inductor current and in normal operation is compared to the peak inductor current setpoint. An inductor current limit condition is detected when V_{SENSE} exceeds 95mV. When the current limit threshold is exceeded, the P-channel MOSFET is immediately turned off by pulling the GATE voltage to V_{IN} regardless of the controller input.

The peak inductor current limit is equal to:

$$I_{L(PEAK)} \cong \left(\frac{95mV}{R_{SENSE}} \right)$$

This inductor current limit would translate to an output current limit based on the inductor ripple and duty factor:

$$I_{OUT(LIMIT)} = \left(\frac{95mV}{R_{SENSE}} - \frac{\Delta I_L}{2} \right) \cdot (1-D)$$

The SENSE pin is a high impedance input with a maximum leakage of $\pm 2\mu A$. Since the LTC3863 is a peak current mode controller, noise on the SENSE pin can create pulse width jitter. Careful attention must be paid to the layout of R_{SENSE} . To ensure the integrity of the current sense signal, V_{SENSE} , the traces from V_{IN} and SENSE pins should be short and run together as a differential pair and Kelvin (4-wire) connected across R_{SENSE} (Figure 3).

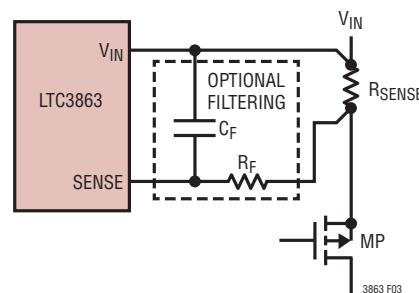

Figure 3. Inductor Current Sensing

APPLICATIONS INFORMATION

The LTC3863 has internal filtering of the current sense voltage which should be adequate in most applications. However, adding a provision for an external filter offers added flexibility and noise immunity, should it be necessary. The filter can be created by placing a resistor from the R_{SENSE} resistor to the SENSE pin and a capacitor across the V_{IN} and SENSE pins.

Power MOSFET Selection

The LTC3863 drives a P-channel power MOSFET that serves as the main switch for the nonsynchronous inverting converter. Important P-channel power MOSFET parameters include drain-to-source breakdown voltage BV_{DSS} , threshold voltage $V_{GS(TH)}$, on-resistance $R_{DS(ON)}$, gate-to-drain reverse transfer capacitance C_{RSS} , maximum drain current $I_{D(MAX)}$, and the MOSFET's thermal resistance $\theta_{JC(MOSFET)}$ and $\theta_{JA(MOSFET)}$.

The drain-to-source breakdown voltage must meet the following condition:

$$BV_{DSS} > V_{IN(MAX)} + |V_{OUT}| + V_D$$

The gate driver bias voltage $V_{IN}-V_{CAP}$ is set by an internal LDO regulator. In normal operation, the CAP pin will be regulated to 8V below V_{IN} . A minimum 0.1 μ F capacitor is required across the V_{IN} and CAP pins to ensure LDO stability. If required, additional capacitance can be added to accommodate higher gate currents without voltage droop. In shutdown and Burst Mode operation, the CAP LDO is turned off. In the event of CAP leakage to ground, the CAP voltage is limited to 9V by a weak internal clamp from V_{IN} to CAP. As a result, a minimum 10V V_{GS} rated MOSFET is required.

The power dissipated by the P-channel MOSFET when the LTC3863 is in continuous conduction mode is given by:

$$P_{PMOS} \approx D \cdot \left(\frac{I_{OUT}}{1-D} \right)^2 \cdot \rho_T \cdot R_{DS(ON)} + \frac{f \cdot C_{MILLER} \cdot (V_{IN} + |V_{OUT}| + V_D)^2}{2} \cdot \frac{I_{OUT}}{1-D} \cdot \left[\frac{R_{DN}}{(V_{IN} - V_{CAP} - V_{MILLER})} + \frac{R_{UP}}{V_{MILLER}} \right]$$

where D is duty factor, $R_{DS(ON)}$ is on-resistance of P-channel MOSFET, ρ_T is temperature coefficient of on-resistance, R_{DN} is the pull-down driver resistance specified at 0.9 Ω typical and R_{UP} is the pull-up driver resistance specified at 2 Ω typical. V_{MILLER} is the Miller effective V_{GS} voltage and is taken graphically from the power MOSFET data sheet.

The power MOSFET input capacitance, C_{MILLER} , is the most important selection criteria for determining the transition loss term in the P-channel MOSFET but is not directly specified on MOSFET data sheets. C_{MILLER} is a combination of several components, but it can be derived from the typical gate charge curve included on most data sheets (Figure 4). The curve is generated by forcing a constant current out of the gate of a common-source connected P-channel MOSFET that is loaded with a resistor, and then plotting the gate voltage versus time. The initial slope is the effect of the gate-to-source and gate-to-drain capacitances. The flat portion of the curve is the result of the Miller multiplication effect of the drain-to-gate capacitance as the drain

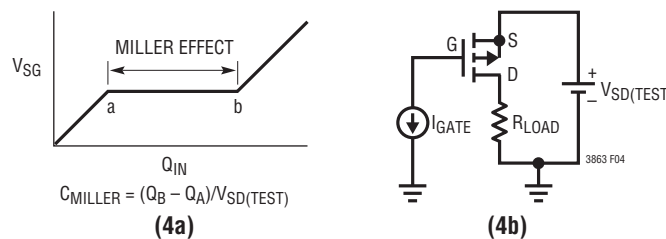

Figure 4. (4a) Typical P-Channel MOSFET Gate Charge Characteristics and (4b) Test Set-Up to Generate Gate Charge Curve

APPLICATIONS INFORMATION

voltage rises across the resistor load. The Miller charge (the increase in coulombs on the horizontal axis from a to b while the curve is flat) is specified for a given V_{SD} test voltage, but can be adjusted for different V_{SD} voltages by multiplying by the ratio of the adjusted V_{SD} to the curve specified V_{SD} value. A way to estimate the C_{MILLER} term is to take the change in gate charge from points a and b (or the parameter Q_{GD} on a manufacturer's data sheet) and dividing it by the specified V_{SD} test voltage, $V_{SD(TEST)}$.

$$C_{MILLER} \cong \frac{Q_{GD}}{V_{SD(TEST)}}$$

The term with C_{MILLER} accounts for transition loss, which is highest at high input voltages. For $V_{IN} < 20V$, the high current efficiency generally improves with larger MOSFETs, while for $V_{IN} > 20V$, the transition losses rapidly increase to the point that the use of a higher $R_{DS(ON)}$ device with lower C_{MILLER} actually provides higher efficiency.

Schottky Diode Selection

When the P-channel MOSFET is turned off, a power Schottky diode is required to function as a commutating diode to carry the inductor current. The average forward diode current is independent of duty factor and is described as:

$$I_{F(AVG)} = I_{OUT}$$

The worst-case condition for diode conduction is a short-circuit condition where the Schottky must handle the maximum current as its duty factor approaches 100% (and the P-channel MOSFET's duty factor approaches 0%). The diode therefore must be chosen carefully to meet worst-case voltage and current requirements. A good practice is to choose a diode that has a forward current rating two times higher than $I_{OUT(MAX)}$.

Once the average forward diode current is calculated, the power dissipation can be determined. Refer to the Schottky diode data sheet for the power dissipation, P_{DIODE} , as a function of average forward current, $I_{F(AVG)}$. P_{DIODE} can also be iteratively determined by the two equations below, where $V_{F(IOUT,TJ)}$ is a function of both $I_{F(AVG)}$ and junction temperature T_J . Note that the thermal resistance, $\theta_{JA(DIODE)}$, given in the data sheet is typical and can be highly layout dependent. It is therefore important to make sure that the Schottky diode has adequate heat sinking.

$$T_J \cong P_{DIODE} \cdot \theta_{JA(DIODE)}$$

$$P_{DIODE} \cong I_{F(AVG)} \cdot V_{D(IOUT,TJ)}$$

The Schottky diode forward voltage is a function of both $I_{F(AVG)}$ and T_J , so several iterations may be required to satisfy both equations. The Schottky forward voltage, V_D , should be taken from the Schottky diode data sheet curve showing instantaneous forward voltage. The forward voltage will change as a function of both T_J and $I_{F(AVG)}$. The nominal forward voltage will also tend to increase as the reverse breakdown voltage increases. It is therefore advantageous to select a Schottky diode appropriate to the input voltage requirements. The diode reverse breakdown voltage must meet the following condition:

$$V_R > V_{IN(MAX)} + |V_{OUT}|$$

C_{IN} and C_{OUT} Selection

The input and output capacitance, C_{IN}/C_{OUT} , are required to filter the square wave current through the P-channel MOSFET and diode respectively. Use a low ESR capacitor sized to handle the maximum RMS current:

$$I_{CIN(RMS)} = I_{COUT(RMS)} = I_{OUT} \cdot \sqrt{\frac{|V_{OUT}| + V_D}{V_{IN}}}$$

APPLICATIONS INFORMATION

The formula shows that the RMS current is greater than the maximum I_{OUT} when V_{OUT} is greater than V_{IN} . Choose capacitors with higher RMS rating with sufficient margin. Note that ripple current ratings from capacitor manufacturers are often based on only 2000 hours of life, which makes it advisable to derate the capacitor.

The selection of C_{OUT} is primarily determined by the ESR required to minimize voltage ripple and load step transients. The ΔV_{OUT} is approximately bounded by:

$$\Delta V_{OUT} \leq I_{L(PEAK)} \cdot ESR + \frac{I_{OUT} \cdot D}{f \cdot C_{OUT}}$$

where $I_{L(PEAK)}$ is the peak inductor current and it's given as:

$$I_{L(PEAK)} = \frac{I_{OUT} (V_{IN} + |V_{OUT}| + V_D)}{V_{IN}} + \frac{V_{IN} \cdot (|V_{OUT}| + V_D)}{2 \cdot L \cdot f \cdot (V_{IN} + |V_{OUT}| + V_D)}$$

Since $I_{L(PEAK)}$ and D reach their maximum values at minimum V_{IN} , the output voltage ripple is highest at minimum V_{IN} and maximum I_{OUT} . Typically, once the ESR requirement is satisfied, the capacitance is adequate for filtering and has the necessary RMS current rating.

Multiple capacitors placed in parallel may be needed to meet the ESR and RMS current handling requirements. Dry tantalum, specialty polymer, aluminum electrolytic and ceramic capacitors are all available in surface mount packages. Specialty polymer capacitors offer very low ESR but have lower specific capacitance than other types. Tantalum capacitors have the highest specific capacitance, but it is important to only use types that have been surge tested for use in switching power supplies. Aluminum electrolytic capacitors have significantly higher ESR, but can be used in cost-sensitive applications provided that consideration is given to ripple current ratings and long-term reliability. Ceramic capacitors have excellent low ESR

characteristics but can have a high voltage coefficient and audible piezoelectric effects.

The high Q of ceramic capacitors with trace inductance can also lead to significant ringing. When used as input capacitors, care must be taken to ensure that ringing from inrush currents and switching does not pose an overvoltage hazard to the power switch and controller. To dampen input voltage transients, add a small 5 μ F to 40 μ F aluminum electrolytic capacitor with an ESR in the range of 0.5 Ω to 2 Ω . High performance through-hole capacitors may also be used, but an additional ceramic capacitor in parallel is recommended to reduce the effect of lead inductance.

Discontinuous and Continuous Operation

The LTC3863 operates in discontinuous conduction (DCM) until the load current is high enough for the inductor current to be positive at the end of the switching cycle. The output load current at the continuous/discontinuous boundary, $I_{OUT(CDB)}$, is given by the following equation:

$$I_{OUT(CDB)} = \frac{V_{IN(MAX)}^2 \cdot (|V_{OUT}| + V_D)}{2 \cdot L \cdot f \cdot (V_{IN(MAX)} + |V_{OUT}| + V_D)^2}$$

The continuous/discontinuous boundary is inversely proportional to the inductor value. Therefore, if required, $I_{OUT(CDB)}$ can be reduced by increasing the inductor value.

External Soft-Start and Output Tracking

Start-up characteristics are controlled by the voltage on the SS pin. When the voltage on the SS pin is less than the internal 0.8V reference, the LTC3863 regulates the V_{FB} pin voltage to the voltage on the SS pin. When the SS pin is greater than the internal 0.8V reference, the V_{FB} pin voltage regulates to the 0.8V internal reference. The SS pin can be used to program an external soft-start function or to allow V_{OUT} to track another supply during start-up.

APPLICATIONS INFORMATION

Soft-start is enabled by connecting a capacitor from the SS pin to ground. An internal $10\mu\text{A}$ current source charges the capacitor, providing a linear ramping voltage at the SS pin that causes V_{OUT} to rise smoothly from 0V to its final regulated value. The total soft-start time will be approximately:

$$t_{\text{SS}} = C_{\text{SS}} \cdot \frac{0.8\text{V}}{10\mu\text{A}}$$

When the LTC3863 is configured to track another supply, a voltage divider can be used from the tracking supply to the SS pin to scale the ramp rate appropriately. Two common implementations of tracking as shown in Figure 5a are coincident and ratiometric. For coincident tracking, choose the divider ratio for the external supply as shown in Figure 5b. Ratiometric tracking could be achieved by using a different ratio than the feedback (Figure 5b).

Note that the soft-start capacitor charging current is always flowing, producing a small offset error. To minimize this error, select the tracking resistive divider values to be small enough to make this offset error negligible.

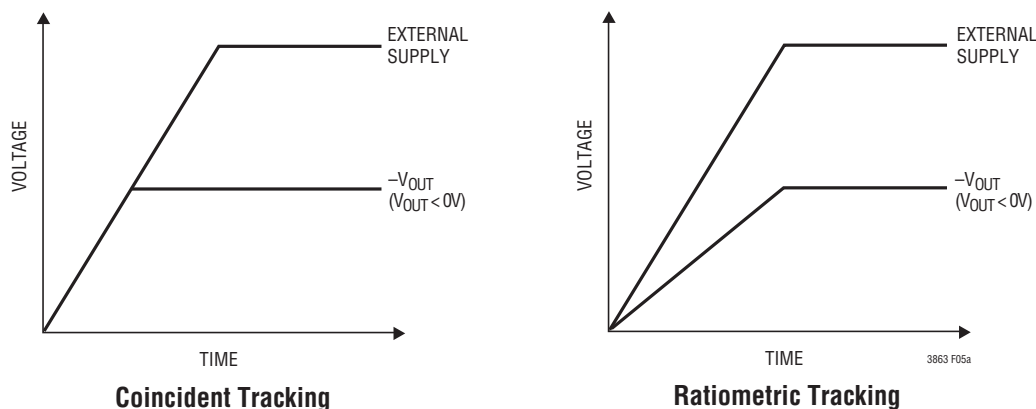

Figure 5a. Two Different Modes of Output Tracking

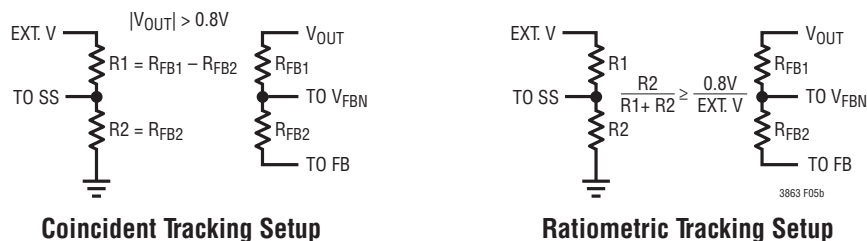

Figure 5b. Setup for Ratiometric and Coincident Tracking

Short-Circuit Faults: Current Limit and Foldback

The inductor current limit is inherently set in a current mode controller by the maximum sense voltage and R_{SENSE} . In the LTC3863, the maximum sense voltage is 95mV , measured across the inductor sense resistor, R_{SENSE} , placed across the V_{IN} and SENSE pins. The output current limit is approximately:

$$I_{\text{LIMIT(MIN)}} = \left(\frac{95\text{mV}}{R_{\text{SENSE}}} - \frac{\Delta I_{\text{L}}}{2} \right) \cdot \frac{V_{\text{IN(MIN)}}}{(V_{\text{IN(MIN)}} + |V_{\text{OUT}}| + V_{\text{D}})}$$

The current limit must be chosen to ensure that $I_{\text{LIMIT(MIN)}} > I_{\text{OUT(MAX)}}$ under all operating conditions. The inductor current limit should be greater than the inductor current required to produce maximum output power at worst-case efficiency. For the LTC3863, both minimum and maximum V_{IN} cases should be checked to determine the worst-case efficiency.

Short-circuit fault protection is assured by the combination of current limit and frequency foldback. When the output feedback voltage, V_{FB} , drops below 0.4V , the operating

APPLICATIONS INFORMATION

frequency, f , will fold back to a minimum value of $0.18 \cdot f$ when V_{FB} reaches 0V. Both current limit and frequency foldback are active in all modes of operation. In a short-circuit fault condition, the output current is first limited by current limit and then further reduced by folding back the operating frequency as the short becomes more severe. The worst-case fault condition occurs when V_{OUT} is shorted to ground.

Short-Circuit Recovery and Internal Soft-Start

An internal soft-start feature guarantees a maximum positive output voltage slew rate in all operational cases. In a short-circuit recovery condition for example, the output recovery rate is limited by the internal soft-start so that output voltage overshoot and excessive inductor current buildup is prevented.

The internal soft-start voltage and the external SS pin operate independently. The output will track the lower of the two voltages. The slew rate of the internal soft-start voltage is roughly 1.2V/ms, which translates to a total soft-start time of 650 μ s. If the slew rate of the SS pin is greater than 1.2V/ms the output will track the internal soft-start ramp. To assure robust fault recovery, the internal soft-start feature is active in all operational cases. If a short-circuit condition occurs which causes the output to drop significantly, the internal soft-start will assure a soft recovery when the fault condition is removed.

The internal soft-start assures a clean soft ramp-up from any fault condition that causes the output to droop, guaranteeing a maximum ramp rate in soft-start, short-circuit fault release. Figure 6 illustrates how internal soft-start controls the output ramp-up rate under varying scenarios.

V_{IN} Undervoltage Lockout (UVLO)

The LTC3863 is designed to accommodate applications requiring widely varying power input voltages from 3.5V to 60V. To accommodate the cases where V_{IN} drops significantly once in regulation, the LTC3863 is guaranteed to operate down to a V_{IN} of 3.5V over the full temperature range.

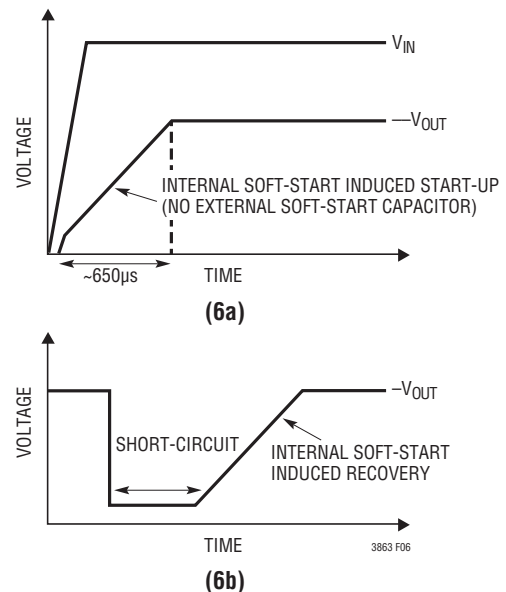

Figure 6. Internal Soft-Start (6a) Allows Soft-Start without an External Soft-Start Capacitor and Allows Soft Recovery from (6b) a Short-Circuit

The implications of both the UVLO rising and UVLO falling specifications must be carefully considered for low V_{IN} operation. The UVLO threshold with V_{IN} rising is typically 3.5V (with a maximum of 3.8V) and UVLO falling is typically 3.25V (with a maximum of 3.5V). The operating input voltage range of the LTC3863 is guaranteed to be 3.5V to 60V over temperature, but the initial V_{IN} ramp must exceed 3.8V to guarantee start-up.

Minimum On-Time Considerations

The minimum on-time, $t_{ON(MIN)}$, is the smallest time duration that the LTC3863 is capable of turning on the power MOSFET, and is typically 220ns. It is determined by internal timing delays and the gate charge required to turn on the MOSFET. Low duty cycle applications may approach this minimum on-time limit, so care should be taken to ensure that:

$$t_{ON(MIN)} < \frac{(|V_{OUT}| + V_D)}{f \cdot (V_{IN(MAX)} + |V_{OUT}| + V_D)}$$

APPLICATIONS INFORMATION

If the duty cycle falls below what can be accommodated by the minimum on-time, the controller will skip cycles. However, the output voltage will continue to regulate.

Efficiency Considerations

The percent efficiency of a switching regulator is equal to the output power divided by the input power times 100%. It is often useful to analyze individual losses to determine the dominant contributors and therefore where efficiency improvements can be made. Percent efficiency can be expressed as:

$$\% \text{ Efficiency} = 100\% - (L1+L2+L3+\dots)$$

where L1, L2, L3, etc., are the individual losses as a percentage of input power.

Although all dissipative elements in the circuit produce losses, four main sources account for most of the losses in LTC3863 application circuits.

1. **Conduction Loss:** Conduction losses result from the P-channel MOSFET $R_{DS(ON)}$, inductor resistance DCR, the current sense resistor R_{SENSE} , and input and output capacitor ESR. The current through DCR is continuous. The currents through both the P-channel MOSFET and Schottky diode are discontinuous. The following equation may be used to determine the total conduction loss (P_{COND}) in continuous conduction mode:

$$P_{COND} \approx \left(\frac{I_{OUT}^2}{(1-D)^2} + \frac{\Delta I_L^2}{12} \right) \cdot \left[R_{DCR} + D \cdot (R_{DS(ON)} + R_{SENSE} + R_{ESR(CIN)}) + (1-D) \cdot R_{ESR(COUT)} \right]$$

2. **Transition Loss:** Transition loss of the P-channel MOSFET becomes significant only when operating at high input voltages (typically 20V or greater.) The P-channel transition losses (P_{MOSTRL}) can be determined from the following equation:

$$P_{PMOSTRL} = \frac{f \cdot C_{MILLER} \cdot (V_{IN} + |V_{OUT}| + V_D)^2}{2} \cdot \frac{I_{OUT}}{1-D} \cdot \left[\frac{R_{DN}}{(V_{IN} - V_{CAP}) - V_{MILLER}} + \frac{R_{UP}}{V_{MILLER}} \right]$$

3. **Gate Charging Loss:** Charging and discharging the gate of the MOSFET will result in an effective gate charging current. Each time the P-channel MOSFET gate is switched from low to high and low again, a packet of charge, dQ , moves from the capacitor across $V_{IN} - V_{CAP}$ and is then replenished from ground by the internal V_{CAP} regulator. The resulting dQ/dt current is a current out of V_{IN} flowing to ground. The total power loss in the controller including gate charging loss is determined by the following equation:

$$P_{CNTRL} = V_{IN} \cdot (I_Q + f \cdot Q_G(PMOSFET))$$

4. **Schottky Loss:** The Schottky loss is independent of duty factors. The critical component is the Schottky forward voltage as a function of junction temperature and current. The Schottky power loss is given by the equation:

$$P_{DIODE} = I_{OUT} \cdot V_D(I_{OUT}, T_J)$$

When making adjustments to improve efficiency, the input current is the best indicator of changes in efficiency. If changes cause the input current to decrease, then the efficiency has increased. If there is no change in input current, there is no change in efficiency.

APPLICATIONS INFORMATION

OPTI-LOOP® Compensation

OPTI-LOOP compensation, through the availability of the ITH pin, allows the transient response to be optimized for a wide range of loads and output capacitors. The ITH pin not only allows optimization of the control loop behavior but also provides a test point for the regulator's DC-coupled and AC-filtered closed-loop response. The DC step, rise time and settling at this test point truly reflects the closed-loop response. Assuming a predominantly second order system, phase margin and/or damping factor can be estimated using the percentage of overshoot seen at this pin. The bandwidth can also be estimated by examining the rise time at this pin.

The ITH series R_{ITH} - C_{ITH1} filter sets the dominant pole-zero loop compensation. Additionally, a small capacitor placed from the ITH pin to signal ground, C_{ITH2} , may be required to attenuate high frequency noise. The values can be modified to optimize transient response once the final PCB layout is done and the particular output capacitor type and value have been determined. The output capacitors need to be selected because their various types and values determine the loop feedback factor gain and phase. An output current pulse of 20% to 100% of full load current having a rise time of 1 μ s to 10 μ s will produce output voltage and ITH pin waveforms that will give a sense of the overall loop stability without breaking the feedback loop. The general goal of OPTI-LOOP compensation is to realize a fast but stable ITH response with minimal output droop due to the load step. For a detailed explanation of OPTI-LOOP compensation, refer to Application Note 76.

Switching regulators take several cycles to respond to a step in load current. When a load step occurs, V_{OUT} immediately shifts by an amount equal to $\Delta I_{LOAD} \cdot ESR$, where ESR is the effective series resistance of C_{OUT} . ΔI_{LOAD} also begins to charge or discharge C_{OUT} , generating a feedback error signal used by the regulator to return V_{OUT} to its steady-state value. During this recovery time, V_{OUT} can be monitored for overshoot or ringing that would indicate a stability problem.

Connecting a resistive load in series with a power MOSFET, then placing the two directly across the output capacitor and driving the gate with an appropriate signal generator is a practical way to produce a realistic load-step condition. The initial output voltage step resulting from the step change in output current may not be within the bandwidth of the feedback loop, so this signal cannot be used to determine phase margin. This is why it is better to look at the ITH pin signal which is in the feedback loop and is the filtered and compensated feedback loop response.

The gain of the loop increases with R_{ITH} and the bandwidth of the loop increases with decreasing C_{ITH1} . If R_{ITH} is increased by the same factor that C_{ITH1} is decreased, the zero frequency will be kept the same, thereby keeping the phase the same in the most critical frequency range of the feedback loop. In addition, a feedforward capacitor, C_{FF} , can be added to improve the high frequency response, as shown in Figure 1. Capacitor C_{FF} provides phase lead by creating a high frequency zero with R_{B1} which improves the phase margin. The output voltage settling behavior is related to the stability of the closed-loop system and will demonstrate overall performance of the regulator.

In some applications, a more severe transient can be caused by switching in loads with large (>10 μ F) input capacitors. If the switch connecting the load has low resistance and is driven quickly, then the discharged input capacitors are effectively put in parallel with C_{OUT} , causing a rapid drop in V_{OUT} . No regulator can deliver enough current to prevent this problem. The solution is to limit the turn-on speed of the load switch driver. A Hot Swap™ controller is designed specifically for this purpose and usually incorporates current limiting, short-circuit protection and soft-start.

Large-Signal Effects on ITH

Inverting controllers have a wide range of applications and operating conditions which affect compensation. Low switching frequencies and the inverting buck-boost right-half-plane zero can result in very low gain crossover frequency requirements. Low crossover frequencies often require a compensation R_{ITH} and C_{ITH} that are too small for

APPLICATIONS INFORMATION

the error amplifier output drive current on ITH of 100 μ A. The effect causes ITH to appear clamped in response to a transient load current step which causes excessive output droop.

An R_{ITH} greater than 20k allows ITH to swing 1.5V with margin for temperature and part to part variation and should never have this issue. In applications with less severe transient load step requirements, R_{ITH} can safely be set as low as 10k. We do not recommend less than 10k in any application. If R_{ITH} is too small then either the operating frequency will need to be increased or the output capacitor increased to increase the R_{ITH} required to stabilize the system. We strongly recommend that any system with an R_{ITH} less than 20k be experimentally verified with worst-case load steps.

Design Example

Consider an inverting converter with the following specifications:

V_{IN} = 4.5V to 55V, V_{OUT} = -5V, I_{OUT(MAX)} = 1.8A, and f = 320kHz (Figure 7).

The output voltage is programmed according to:

$$V_{OUT} = -0.8V \cdot \frac{R_{FB2}}{R_{FB1}}$$

If R_{FB2} is chosen to be 188k, then R_{FB1} needs to be 30.1k.

The FREQ pin is tied to signal ground in order to program the switching frequency to 350kHz. The on-time required to generate -5V output from 55V V_{IN} in continuous mode can be calculated as:

$$t_{ON(CCM)} = \frac{5V + 0.5V}{320kHz \cdot (55V + 5V + 0.5V)} = 260ns$$

This on-time, t_{ON}, is larger than LTC3863's minimum on-time with sufficient margin to prevent cycle skipping. Use a lower frequency if a larger on-time margin is needed to account for variations from minimum on-time and switching frequency. As load current decreases, the converter will eventually start cycle skipping.

Next, set the inductor value such that the inductor ripple current is 60% of the average inductor current at maximum V_{IN} = 55V and full load = 1.8A:

$$L = \frac{55V^2 \cdot (5V + 0.5V)}{0.6 \cdot 1.8A \cdot 320kHz \cdot (55V + 5V + 0.5V)^2} \approx 13.1\mu H$$

Select a standard value of 12 μ H.

The resulting ripple current at minimum V_{IN} of 4.5V is:

$$\Delta I_L = \frac{5V \cdot (5V + 0.5V)}{12\mu H \cdot 320kHz \cdot (5V + 5V + 0.5V)} = 0.644A$$

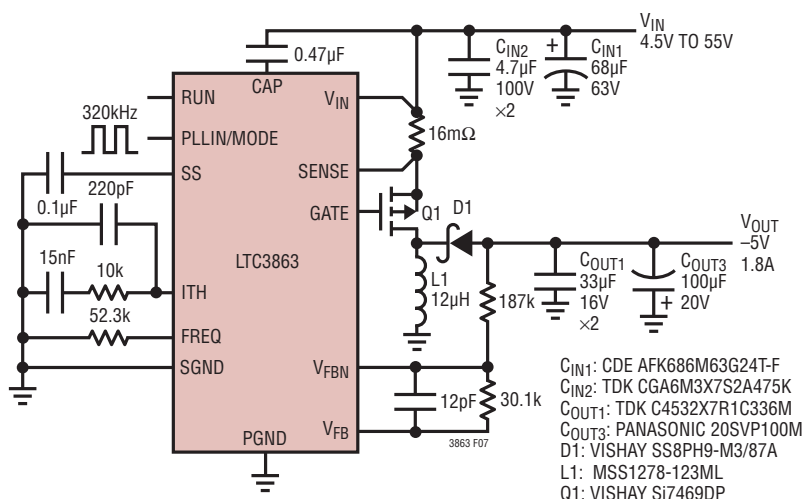

Figure 7. Design Example (4.5V to 55V Input, -5V, 1.8A at 320kHz)

APPLICATIONS INFORMATION

The boundary output current for continuous/discontinuous mode is calculated:

$$I_{OUT(CDB)} = \frac{55V^2 \cdot 5V}{2 \cdot 12\mu H \cdot 320kHz \cdot (55V + 5V)^2} = 0.55A$$

The maximum inductor peak current occurs at minimum V_{IN} of 4.5V and full load of 1.8A where LTC3863 operates in continuous mode is:

$$\begin{aligned} I_{L(PEAK_MAX)} &= \frac{1.8A \cdot (4.5V + 5V + 0.5V)}{5V} + \frac{\Delta I_L}{2} \\ &= 3.6A + \frac{0.644A}{2} \approx 4.25A \end{aligned}$$

Next, set the R_{SENSE} resistor value to ensure that the converter can deliver the maximum peak inductor current of 4.25A with sufficient margin to account for component variations and worst-case operating conditions. Using a 30% margin factor:

$$R_{SENSE} = \frac{95mV}{1.3 \cdot 4.25A} = 17.2m\Omega$$

Use a more readily available 16m Ω sense resistor. This results in peak inductor current limit:

$$I_{L(PEAK)} = \frac{95mV}{16m\Omega} = 5.94A$$

Choose an inductor that has rated saturation current higher than 5.94A with sufficient margin.

The output current limit can be calculated from the peak inductor current limit and its minimum occurs at minimum V_{IN} of 5V:

$$\begin{aligned} I_{LIMIT(MIN)} &= \left(\frac{95mV}{16m\Omega} - \frac{0.644A}{2} \right) \cdot \frac{5V}{(4.5V + 5V + 0.5V)} \\ &= 2.8A \end{aligned}$$

In this example, 2.8A is the maximum output current the switching regulator can support at $V_{IN} = 4.5V$. It is larger than the full load of 1.8A by a margin of 1A. If a larger margin is needed, use a smaller R_{SENSE} .

Next choose a P-channel MOSFET with the appropriate BV_{DSS} and I_D rating. The BV_{DSS} rating should be greater than $(55V + 5V + V_D)$ with sufficient margin. In this example, a good choice is the Vishay Si7469DP ($BV_{DSS} = 80V$, $I_D = 10A$, $R_{DS(ON)} = 30m\Omega$, $\rho_{100^\circ C} = 1.8$, $V_{MILLER} = 3.2V$, $C_{MILLER} = 235pF$, $\theta_{JA} = 24^\circ C/W$). The highest power dissipation and the resulting junction temperature for the P-channel MOSFET occurs at the minimum V_{IN} of 5V and maximum output current of 1.8A. They can be calculated at $T_A = 70^\circ C$ as follows:

$$D = \frac{5V + 0.5V}{4.5V + 5V + 0.5V} \approx 0.55$$

$$P_{PMOS} = 0.55 \cdot \left(\frac{1.8A}{1 - 0.55} \right)^2 \cdot 1.8 \cdot 30m\Omega$$

$$+ \frac{320kHz \cdot 235pF \cdot (4.5V + |-5V| + 0.5V)^2}{2}$$

$$\cdot \frac{1.8A}{(1 - 0.55)} \cdot \left(\frac{0.9\Omega}{4.5V - 3.2V} + \frac{2\Omega}{3.2V} \right)$$

$$\approx 0.475W + 0.020W \approx 0.495W$$

$$T_J = 70^\circ C + 0.495W \cdot 24^\circ C/W = 82^\circ C$$

The same calculations can be repeated for $V_{IN(MAX)} = 55V$:

$$D = \frac{5V + 0.5V}{55V + 5V + 0.5V} \approx 0.091$$

$$P_{PMOS} \approx 0.091 \cdot \left(\frac{1.8A}{1 - 0.091} \right)^2 \cdot 1.8 \cdot 30m\Omega$$

$$+ \frac{320kHz \cdot 235pF \cdot (55V + |-5V| + 0.5V)^2}{2}$$

$$\cdot \frac{1.8A}{(1 - 0.091)} \cdot \left(\frac{0.9\Omega}{5V - 3.2V} + \frac{2\Omega}{3.2V} \right)$$

$$\approx 0.019W + 0.39W \approx 0.411W$$

$$T_J = 70^\circ C + 0.411W \cdot 24^\circ C/W = 80^\circ C$$

Next choose an appropriate Schottky diode that will handle the power requirements. The reverse voltage of the diode, V_R , should be greater than $(55V + 5V)$. The Fairchild S38 Schottky diode is selected ($V_F(3A, 125^\circ C) = 0.45V$,

APPLICATIONS INFORMATION

$V_R = 80V$, $\theta_{JA} = 55^\circ C/W$) for this application. The power dissipation and junction temperature at $T_A = 70^\circ$ and full load = 1.8A can be calculated as:

$$P_{DIODE} = 1.8A \cdot 0.45V = 0.81W$$

$$T_J = 70^\circ C + 0.81W \cdot 55^\circ C/W = 114^\circ C$$

These power dissipation calculations show that careful attention to heat sinking will be necessary.

For the input bypass capacitors, choose low ESR ceramic capacitors that can handle the maximum RMS current at the minimum V_{IN} of 4.5V:

$$I_{CIN(RMS)} \approx 1.8A \cdot \sqrt{\frac{|-5V|}{4.5V}} = 1.9A$$

C_{OUT} will be selected based on the ESR that is required to satisfy the output voltage ripple requirement. For this design, two 47 μ F ceramic capacitors are chosen to offer low ripple in both normal operation and in Burst Mode operation.

The selected C_{OUT} must support the maximum RMS operating current at a minimum V_{IN} of 4.5V:

$$I_{CIN(RMS)} \approx 1.8A \cdot \sqrt{\frac{|-5V|}{4.5V}} = 1.9A$$

A soft-start time of 8ms can be programmed through a 0.1 μ F capacitor on the SS pin:

$$C_{SS} = \frac{8ms \cdot 10\mu A}{0.8V} = 0.1\mu F$$

Loop compensation components on the ITH pin are chosen based on load step transient behavior (as described under OPTI-LOOP Compensation) and is optimized for stability. A pull-up resistor is used on the RUN pin for FMEA compliance (see Failure Modes and Effects Analysis).

An application with complementary dual outputs of $\pm 5V$ can be designed by using two LTC3863 parts with one configured into an inverting regulator and the other into a step-down buck regulator as shown in Figure 11. Refer to LTC3864 data sheet for the actual design of a buck output of 5V.

Gate Driver Component Placement, Layout and Routing

It is important to follow recommended power supply PC board layout practices such as placing external power elements to minimize loop area and inductance in switching paths. Be careful to pay particular attention to gate driver component placement, layout and routing.

The effective C_{CAP} capacitance should be greater than 0.1 μ F minimum in all operating conditions. Operating voltage and temperature both decrease the rated capacitance to varying degrees depending on dielectric type. The LTC3863 is a PMOS controller with an internal gate driver and bootstrapped LDO that regulates the differential CAP voltage ($V_{IN} - V_{CAP}$) to 8V nominal. The C_{CAP} capacitance needs to be large enough to assure stability and provide cycle-to-cycle current to the PMOS switch with minimum series inductance. We recommend a ceramic 0.47 μ F 16V capacitor with a high quality dielectric such as X5R or X7R. Some high current applications with large Qg PMOS switches may benefit from an even larger C_{CAP} capacitance.

Figure 8 shows the LTC3863 Generic Application Schematic which includes an optional current sense filter and series gate resistor. Figure 9 illustrates the recommended gate driver component placement, layout and routing of the GATE, V_{IN} , SENSE and CAP pins and key gate driver components. It is recommended that the gate driver layout follow the example shown in Figure 9 to assure proper operation and long term reliability.

The LTC3863 gate driver should connect to the external power elements in the following manner. First route the V_{IN} pin using a single low impedance isolated trace to the positive R_{SENSE} resistor PAD without connection to the V_{IN} plane. The reason for this precaution is that the V_{IN} pin is internally Kelvin connected to the current sense comparator, internal V_{IN} power and the PMOS gate driver. Connecting the V_{IN} pin to the V_{IN} power plane adds noise and can result in jitter or instability. Figure 9 shows a single V_{IN} trace from the positive R_{SENSE} pad connected to C_{SF} , C_{CAP} , V_{IN} pad and C_{INB} . The total trace length to R_{SENSE} should be minimized and the capacitors C_{CF} , C_{CAP} and C_{INB} should be placed near the V_{IN} pin of the LTC3863.

APPLICATIONS INFORMATION

- Place C_{IN} , sense resistor, P-channel MOSFET, inductor, and primary C_{OUT} capacitors close together in one compact area. The junction connecting the drain of the P-channel MOSFET, cathode of the Schottky, and (+) terminal of the inductor (this junction is commonly referred to as switch or phase node) should be compact but be large enough to handle the inductor currents without large copper losses. Place the sense resistor and source of P-channel MOSFET as close as possible to the (+) plate of the C_{IN} capacitor(s) that provides the bulk of the AC current (these are normally the ceramic capacitors), and connect the (-) terminal of the inductor as close as possible to the (-) terminal of the same C_{IN} capacitor(s). The high di/dt loop formed by C_{IN} , the MOSFET, and the Schottky diode should have short leads and PCB trace lengths to minimize high frequency EMI and voltage stress from inductive ringing. The (+) terminal of the primary C_{OUT} capacitor(s) which filter the bulk of the inductor ripple current (these are normally the ceramic capacitors) should also be connected close to the (-) terminal of C_{IN} .
- Place Pins 7 to 12 facing the power train components. Keep high dV/dt signals on GATE and switch away from sensitive small-signal traces and components.
- Place the sense resistor close to the (+) terminal of C_{IN} and source of P-channel MOSFET. Use a Kelvin (4-wire) connection across the sense resistor and route the traces together as a differential pair into the V_{IN} and SENSE pins. An optional RC filter could be placed near the V_{IN} and SENSE pins to filter the current sense signal.
- Place the resistive feedback divider $R_{FB1/2}$ as close as possible to the V_{FB} and V_{FBN} pins. The (-) terminal of the feedback divider should connect to the output regulation point and the (+) terminal of the feedback divider should connect to V_{FB} .
- Place the ceramic C_{CAP} capacitor as close as possible to the V_{IN} and CAP pins. This capacitor provides the gate discharging current for the power P-channel MOSFET.
- Place small signal components as close to their respective pins as possible. This minimizes the possibility of PCB noise coupling into these pins. Give priority to V_{FB} , ITH,

and R_{FREQ} pins. Use sufficient isolation when routing a clock signal into the PLLIN /MODE pin so that the clock does not couple into sensitive small-signal pins.

Failure Mode and Effects Analysis (FMEA)

A FMEA study on the LTC3863 has been conducted through adjacent pin opens and shorts. The device was tested in a step-down application (Figure 15) from $V_{IN} = 12V$ to $V_{OUT} = -5V$ with a current load of 2A on the output. One group of tests involved the application being monitored while each pin was disconnected from the PC board and left open while all other pins remained intact. The other group of tests involved each pin being shorted to its adjacent pins while all other pins were connected as it would be normally in the application. The results are shown in Table 2.

For FMEA compliance, the following design implementations are recommended:

- If the RUN pin is being pulled up to a voltage greater than 6V, then it is done so through a pull-up resistor (100k to 1M) so that the V_{FBN} pin is not damaged in case of a RUN to V_{FBN} short.
- The gate of the external P-channel MOSFET should be pulled through a resistor (20k to 100k) to the input supply, V_{IN} so that the P-channel MOSFET is guaranteed to turn off in case of a GATE open.
- To protect against the V_{FBN} open condition it is necessary to add an output shutdown clamp. The output shutdown clamp is comprised of a Zener, V_Z , NPN and Zener bias resistor, R_Z , to ground as found in Figure 10. The clamp voltage will be the Zener forward voltage V_Z plus a V_{BE} . The clamp needs to be designed such that the worst-case minimum Zener voltage is less than the maximum operating voltage. The worst-case Zener leakage current times the Zener bias resistor should not exceed 200mV.

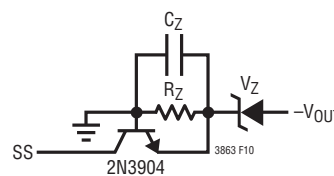

Figure 10

APPLICATIONS INFORMATION

Table 2

FAILURE MODE	V _{OUT}	I _{OUT}	I _{VIN}	f	RECOVERY WHEN FAULT IS REMOVED?	BEHAVIOR
None	-5V	1A	453mA	350kHz	N/A	Normal Operation.
Pin Open						
Open Pin 1 (PLLIN/MODE)	-5V	1A	453mA	350kHz	OK	Pin already left open in normal application, so no difference.
Open Pin 2 (FREQ)	-5V	1A	453mA	535kHz	OK	Frequency jumps to default open value.
Open Pin 3 (GND)	-5V	1A	453mA	350kHz	OK	Exposed pad still provides GND connection to device.
Open Pin 4 (SS)	-5V	1A	453mA	350kHz	OK	External soft-start removed, but internal soft-start still available.
Open Pin 5 (V _{FB})	0V	0A	0.7mA	0kHz	OK	Controller stops switching. V _{FB} internally self biases HI to prevent switching.
Open Pin 6 (ITH)	-5V	1A	507mA	40kHz	OK	Output still regulating, but the switching is erratic. Loop not stable.
Open Pin 7 (V _{FBN})	-6V pk	1A	502mA	350kHz	OK	Use a 5.1V Zener V _Z , 10k R _Z and 0.01μF C _Z . Output Voltage is -6V peak and averages -4.9V.
Open Pin 8 (RUN)	-5V	1A	453mA	350kHz	OK	Controller does not start-up.
Open Pin 9 (CAP)	-5V	1A	453mA	350kHz	OK	More jitter during switching, but regulates normally.
Open Pin 10 (SENSE)	0V	0A	0.7mA	0kHz	OK	SENSE internally prebiases to 0.6V below V _{IN} . This prevents controller from switching.
Open Pin 11 (V _{IN})	-5.4V	1A	597mA	20kHz	OK	V _{IN} able to bias internally through SENSE. Regulates with high V _{OUT} ripple.
Open Pin 12 (GATE)	0V	0A	0.7mA	0kHz	OK	Gate does not drive external power FET, preventing output regulation.
Open Pin 13 (PGND)	-5V		453mA	350kHz	OK	Pin 3 (GND) still provides GND connection to device.
Pins Shorted						
Short Pins 1, 2 (PLLIN/MODE and FREQ)	-5V	1A	453mA	350kHz	OK	Burst Mode operation disabled, but runs normally as in pulse-skipping mode.
Short Pins 2, 3 (FREQ and GND)	-5V	1A	453mA	0kHz	OK	FREQ already shorted to GND, so regulates normally.
Short Pins 3, 4 (GND and SS)	0V	0A	0.7mA	0kHz	OK	SS short to GND prevents device from starting up.
Short Pins 4, 5 (SS and V _{FB})	-1V(DC) -3V _{P-P}	50mA	9mA	Erratic	OK	V _{OUT} oscillates from 0V to 3V.
Short Pins 5, 6 (V _{FB} and ITH)	-3.15V	625mA	181mA	350kHz	OK	Controller loop does not regulate to proper output voltage.
Short Pins 7, 8 (V _{FBN} and RUN)	5V	0A	860μA	350kHz	OK	Controller does not start-up.
Short Pins 8, 9 (RUN and CAP)	-5V	1A	453mA	350kHz	OK	Able to start-up and regulate normally.
Short Pins 9, 10 (CAP and SENSE)	0V	0A	181mA	0kHz	OK	CAP ~ V _{IN} , which prevents turning on external P-MOSFET.
Short Pins 10, 11 (SENSE and V _{IN})	-5V	1A	453mA	50kHz	OK	Regulates with high V _{OUT} ripple.
Short Pins 11, 12 (V _{IN} and GATE)	0V	0A	29mA	0kHz	OK	Power MOSFET is always kept OFF, preventing regulation.

TYPICAL APPLICATIONS

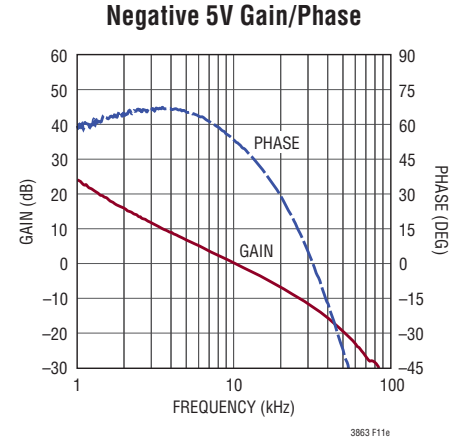
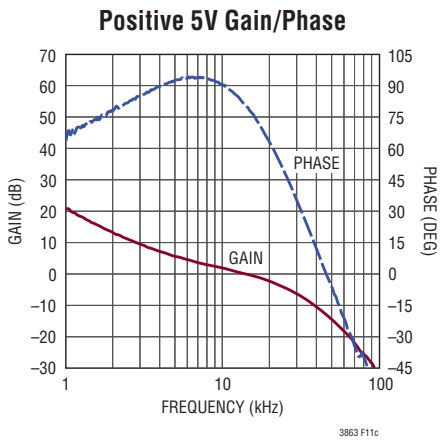
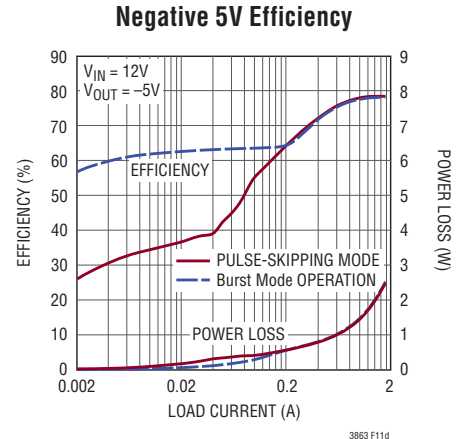
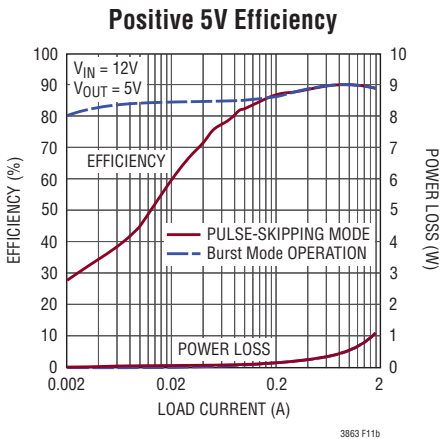
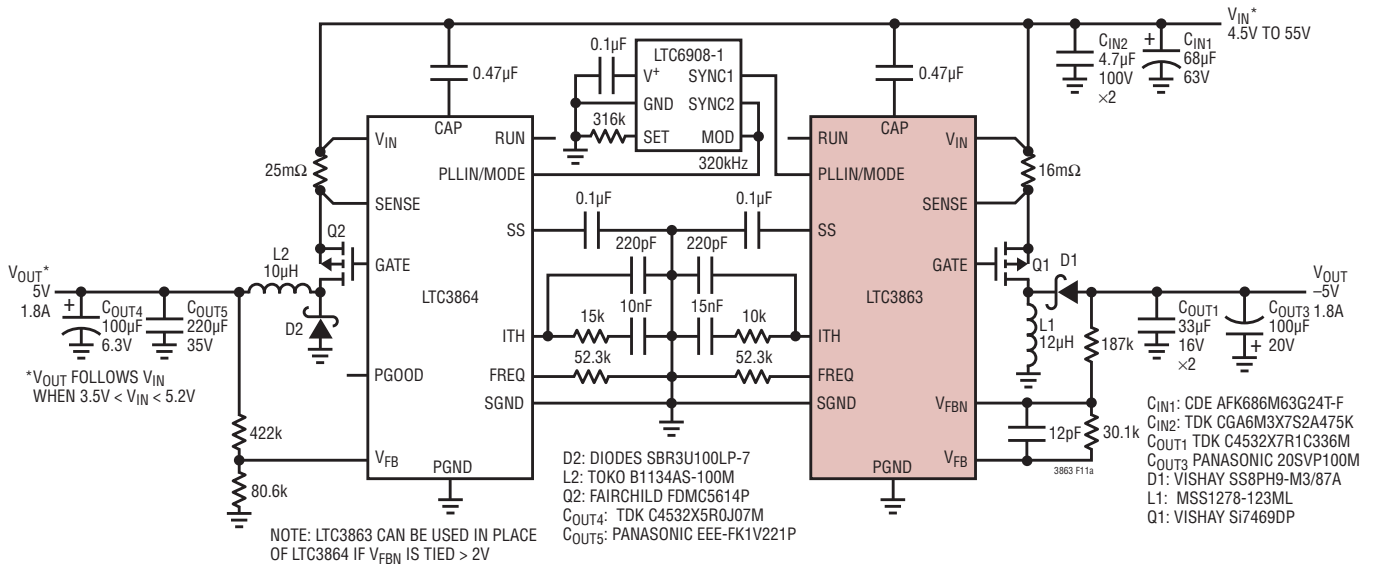

Figure 11. Design Example, 4.5V to 55V Input, ±5V, 1.8A at 320kHz

Gain/Phase Measurements Taken with OMICRON Lab Bode 100 Vector Network Analyzer.

TYPICAL APPLICATIONS

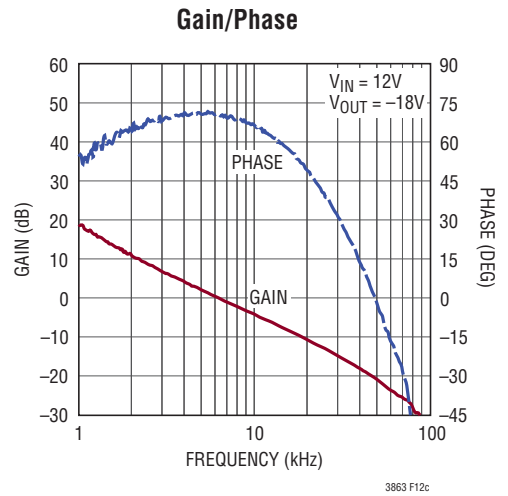
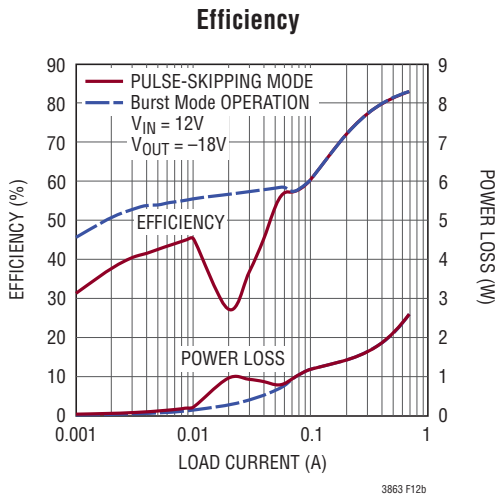
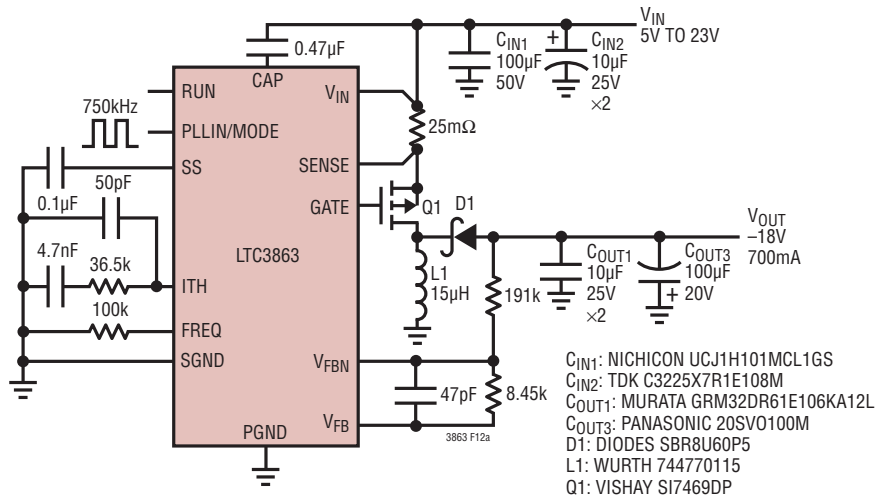

Figure 12. 5V to 23V Input, -18V/700mA Output, 750kHz Inverting Converter

Gain/Phase Measurements Taken with OMICRON Lab Bode 100 Vector Network Analyzer.

TYPICAL APPLICATIONS

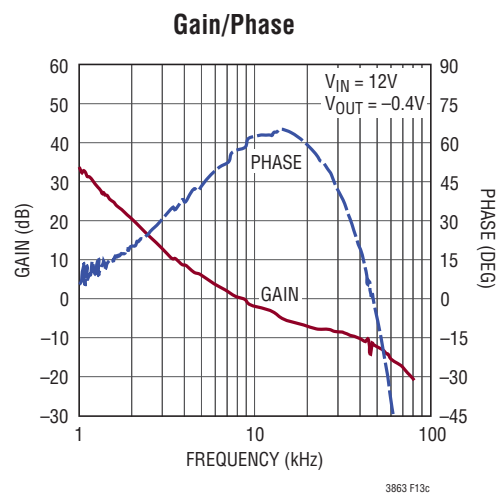
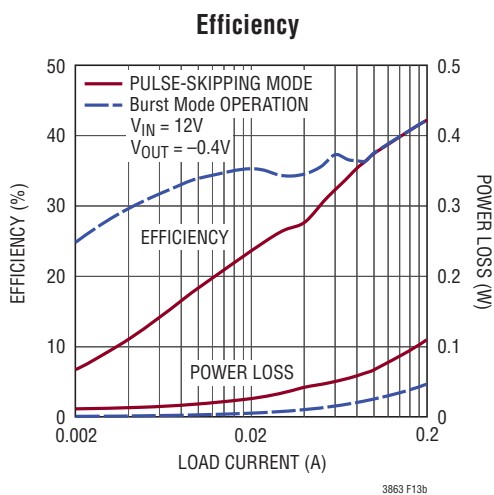
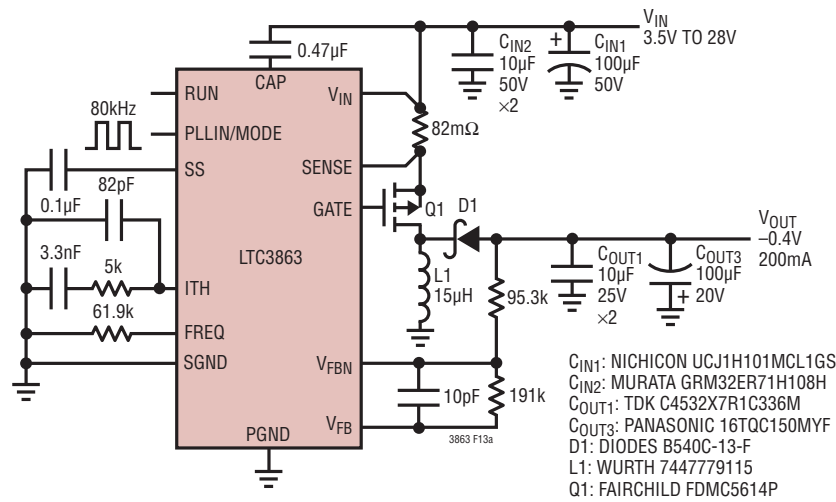

Figure 13. 3.5V to 28V Input, -0.4V/200mA Output, 80kHz Inverting Converter

Gain/Phase Measurements Taken with OMICRON Lab Bode 100 Vector Network Analyzer.

TYPICAL APPLICATIONS

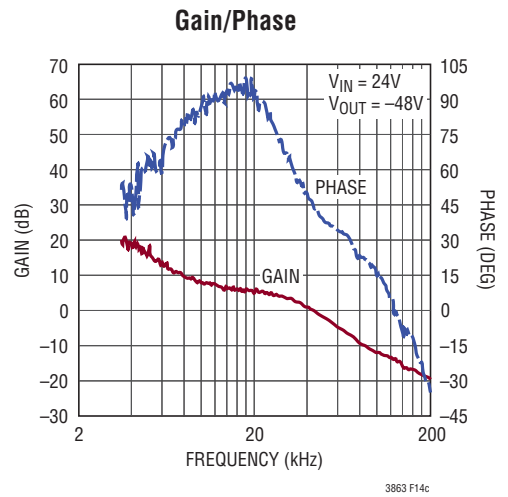
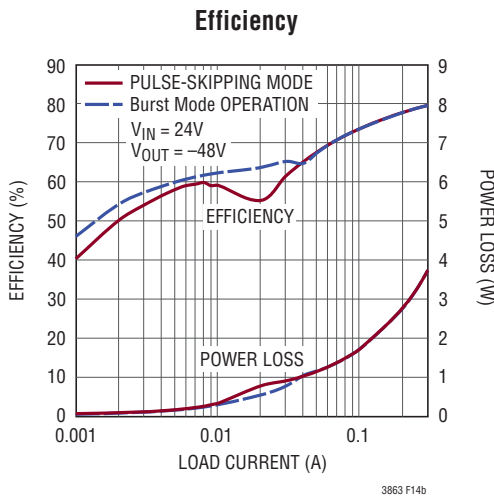
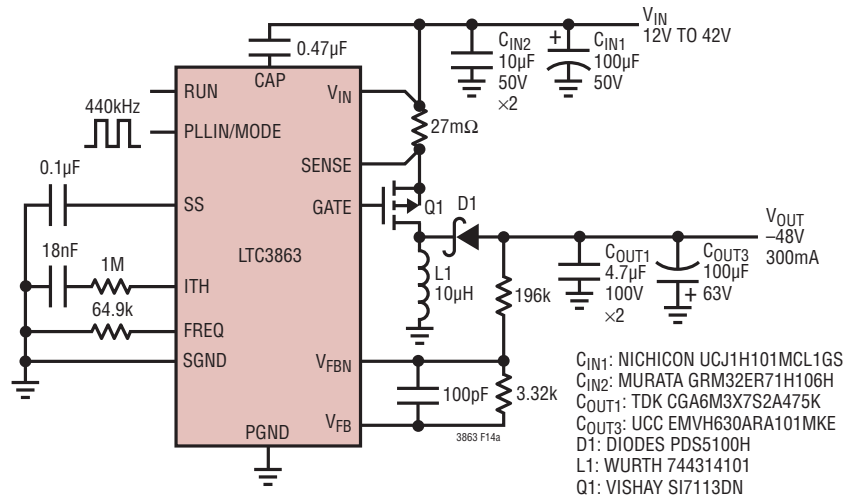
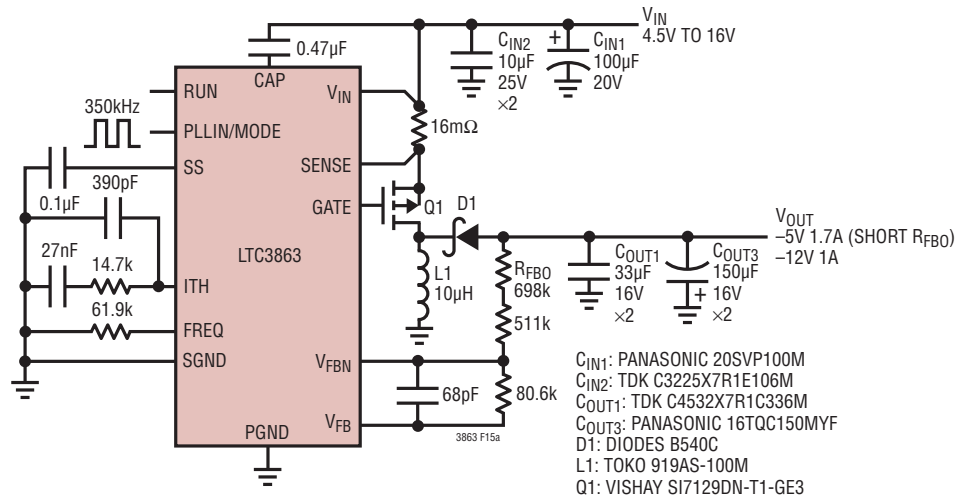

Figure 14. 12V to 42V Input, -48V/300mA Output, 440kHz Inverting Converter

Gain/Phase Measurements Taken with OMICRON Lab Bode 100 Vector Network Analyzer.

TYPICAL APPLICATIONS



-5V Efficiency

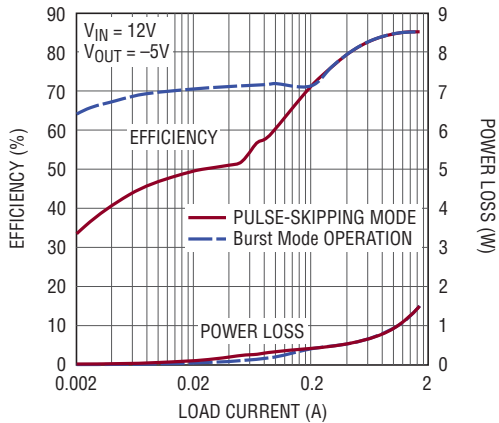

-12V Efficiency

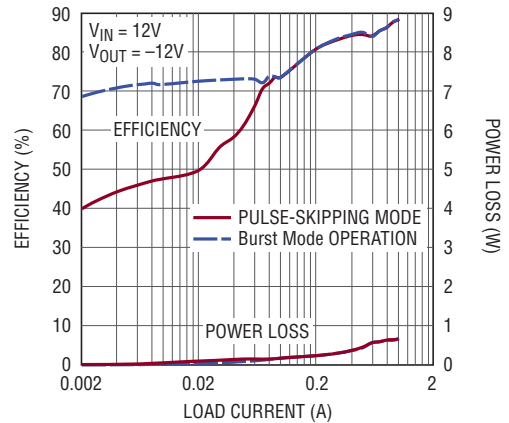
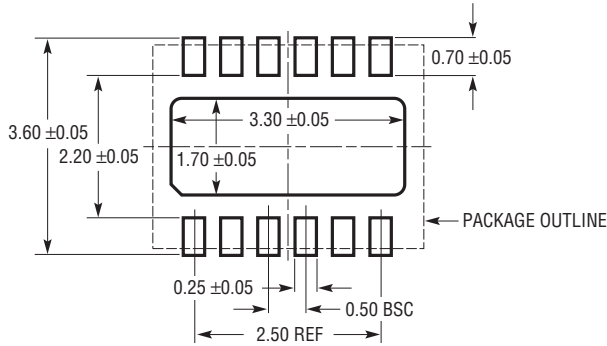

Figure 15. 4.5V to 16V Input, -5V/1.7A, -12V/1A Output, 350kHz Inverting Converter

PACKAGE DESCRIPTION

Please refer to <http://www.linear.com/designtools/packaging/> for the most recent package drawings.

DE/UE Package
12-Lead Plastic DFN (4mm × 3mm)
 (Reference LTC DWG # 05-08-1695 Rev D)



RECOMMENDED SOLDER PAD PITCH AND DIMENSIONS
 APPLY SOLDER MASK TO AREAS THAT ARE NOT SOLDERED

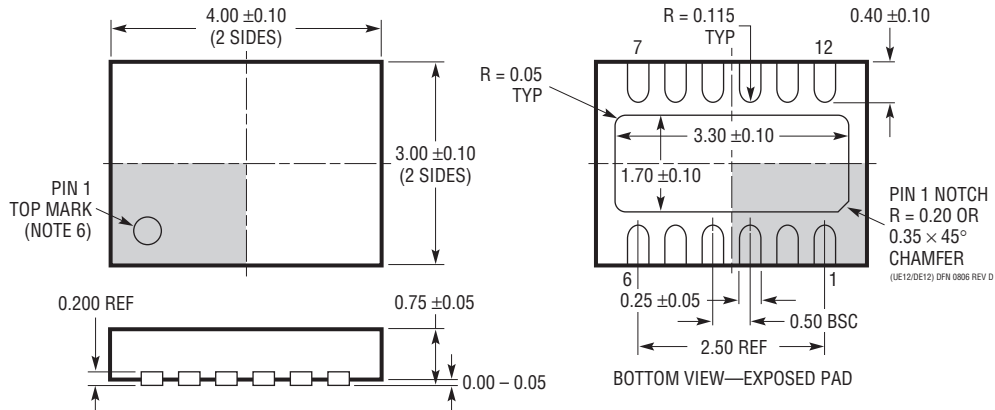

- NOTE:
1. DRAWING PROPOSED TO BE A VARIATION OF VERSION (WGED) IN JEDEC PACKAGE OUTLINE M0-229
 2. DRAWING NOT TO SCALE
 3. ALL DIMENSIONS ARE IN MILLIMETERS
 4. DIMENSIONS OF EXPOSED PAD ON BOTTOM OF PACKAGE DO NOT INCLUDE MOLD FLASH. MOLD FLASH, IF PRESENT, SHALL NOT EXCEED 0.15mm ON ANY SIDE
 5. EXPOSED PAD SHALL BE SOLDER PLATED
 6. SHADED AREA IS ONLY A REFERENCE FOR PIN 1 LOCATION ON THE TOP AND BOTTOM OF PACKAGE

PACKAGE DESCRIPTION

Please refer to <http://www.linear.com/designtools/packaging/> for the most recent package drawings.

MSE Package 12-Lead Plastic MSOP, Exposed Die Pad (Reference LTC DWG # 05-08-1666 Rev F)

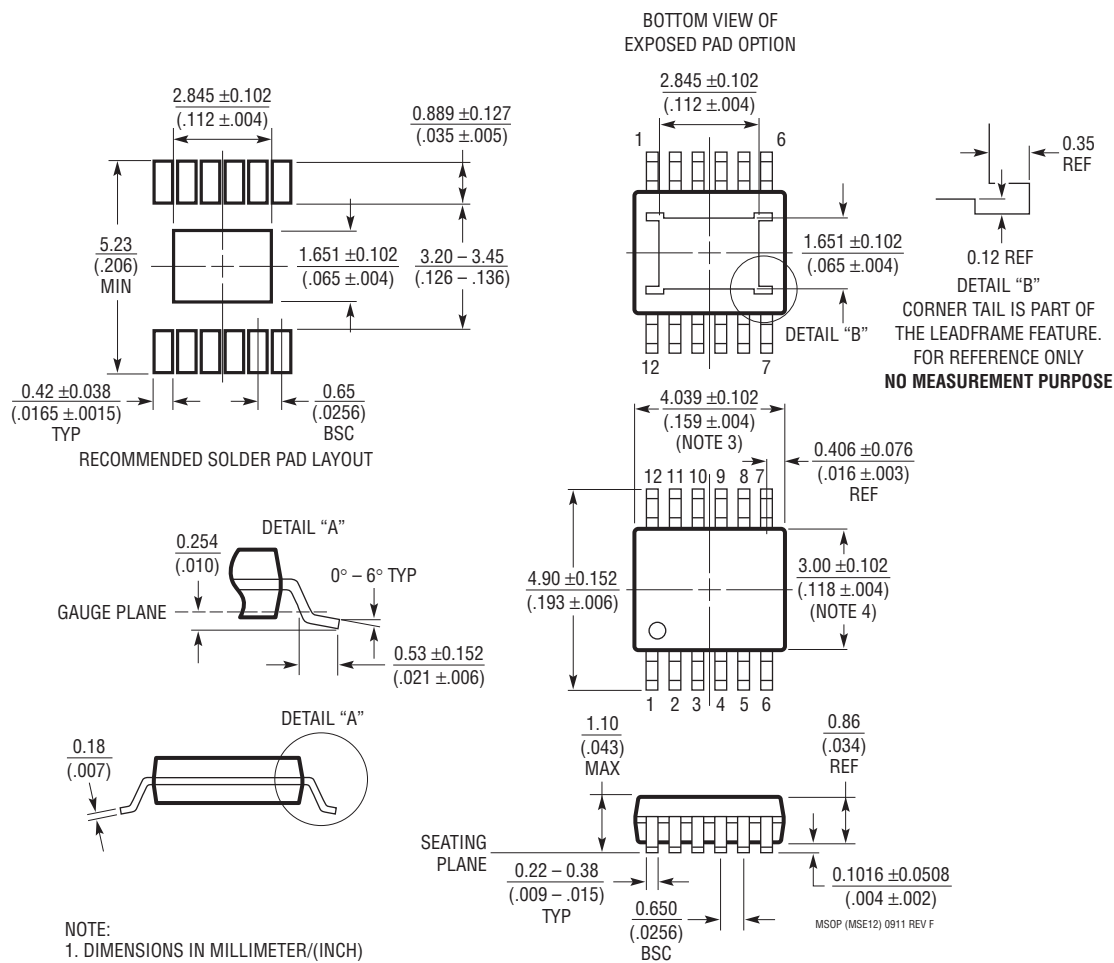

NOTE:

1. DIMENSIONS IN MILLIMETER/(INCH)
2. DRAWING NOT TO SCALE
3. DIMENSION DOES NOT INCLUDE MOLD FLASH, PROTRUSIONS OR GATE BURRS.
MOLD FLASH, PROTRUSIONS OR GATE BURRS SHALL NOT EXCEED 0.152mm (.006") PER SIDE
4. DIMENSION DOES NOT INCLUDE INTERLEAD FLASH OR PROTRUSIONS.
INTERLEAD FLASH OR PROTRUSIONS SHALL NOT EXCEED 0.152mm (.006") PER SIDE
5. LEAD COPLANARITY (BOTTOM OF LEADS AFTER FORMING) SHALL BE 0.102mm (.004") MAX
6. EXPOSED PAD DIMENSION DOES INCLUDE MOLD FLASH. MOLD FLASH ON E-PAD SHALL NOT EXCEED 0.254mm (.010") PER SIDE.

TYPICAL APPLICATION

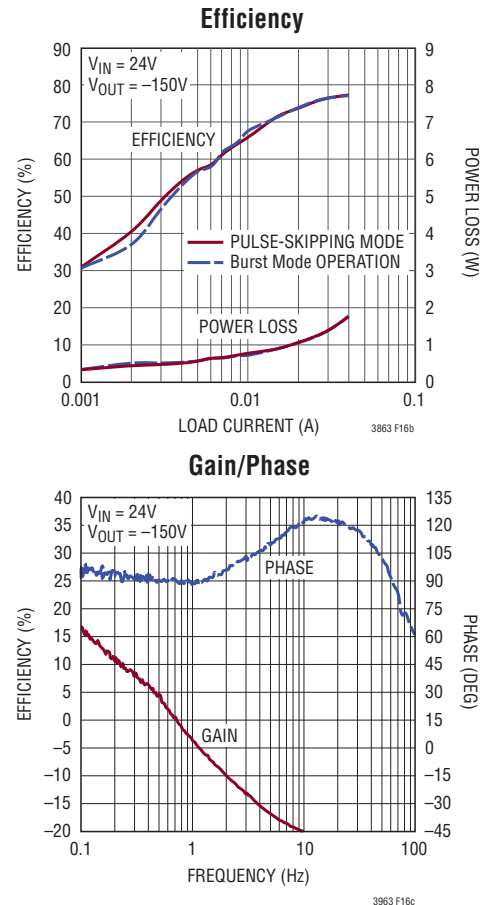
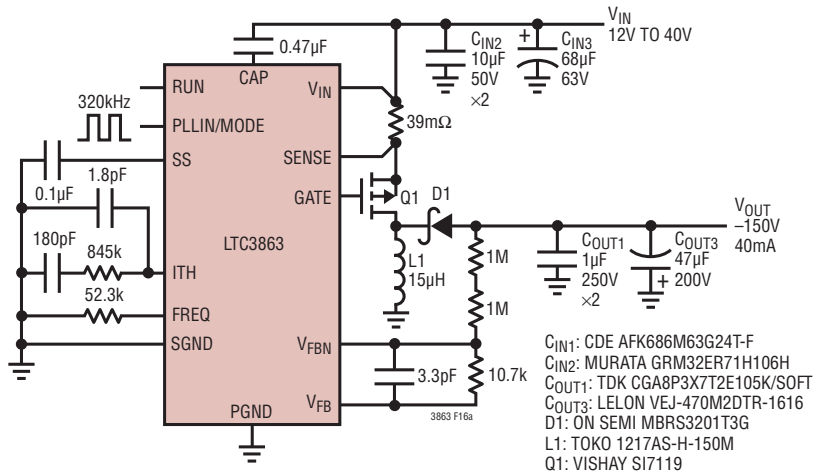

Figure 16. 12V to 40V Input, -150V/40mA Output, 320kHz Inverting Converter

Gain/Phase Measurements Taken with OMICRON Lab Bode 100 Vector Network Analyzer.

RELATED PARTS

PART NUMBER	DESCRIPTION	COMMENTS
LTC3864	Low I_Q , High Voltage Step-Down DC/DC Controller with 100% Duty Cycle	Fixed Frequency 50kHz to 850kHz, $3.5V \leq V_{IN} \leq 60V$, $0.8V \leq V_{OUT} \leq V_{IN}$, $I_Q = 40\mu A$, MSOP-12E, 3mm \times 4mm DFN-12
LTC3891	60V, Low I_Q , Synchronous Step-Down DC/DC Controller	PLL Fixed Frequency 50kHz to 900kHz, $4V \leq V_{IN} \leq 60V$, $0.8V \leq V_{OUT} \leq 24V$, $I_Q = 50\mu A$
LTC3890/LTC3890-1 LTC3890-2/LTC3890-3	60V, Low I_Q , Dual 2-Phase Synchronous Step-Down DC/DC Controller	PLL Fixed Frequency 50kHz to 900kHz, $4V \leq V_{IN} \leq 60V$, $0.8V \leq V_{OUT} \leq 24V$, $I_Q = 50\mu A$
LTC3630	High Efficiency, 65V, 500mA Synchronous Step-Down Regulator	$4V \leq V_{IN} \leq 65V$, $0.8V \leq V_{OUT} \leq V_{IN}$, $I_Q = 12\mu A$, 3mm \times 5mm DFN-16 and MSOP-16E
LTC3834/LTC3834-1 LTC3835/LTC3835-1	Low I_Q , Single Output Synchronous Step-Down DC/DC Controllers with 99% Duty Cycle	PLL Fixed Frequency 140kHz to 650kHz, $4V \leq V_{IN} \leq 36V$, $0.8V \leq V_{OUT} \leq 10V$, $I_Q = 30\mu A/80\mu A$
LT3758A	High Input Voltage, Boost, Flyback, SEPIC and Inverting Controller	$5.5V \leq V_{IN} \leq 100V$, Positive or Negative V_{OUT} , 3mm \times 3mm DFN-10 and MSOP-10E
LTC3826/LTC3826-1	Low I_Q , Dual Output 2-Phase Synchronous Step-Down DC/DC Controllers with 99% Duty Cycle	PLL Fixed Frequency 50kHz to 900kHz, $4V \leq V_{IN} \leq 36V$, $0.8V \leq V_{OUT} \leq 10V$, $I_Q = 30\mu A$
LTC3859AL	Low I_Q , Triple Output Buck/Buck/Boost Synchronous DC/DC Controller	All Outputs Remain in Regulation Through Cold Crank $2.5V \leq V_{IN} \leq 38V$, $V_{OUT(BUCKS)}$ Up to 24V, $V_{OUT(BOOST)}$ Up to 60V, $I_Q = 28\mu A$